

Reference Only

CHIP COIL (CHIP INDUCTORS) LQW2BAN□□□□00L REFERENCE SPECIFICATION

1.Scope

This reference specification applies to LQW2BAN_00 Series Chip coil(Chip Inductors).

2.Part Numbering

(ex)	LQ	W	2B	A	N	47N	G	0	0	L
	Product ID	Structure	Dimension (L×W)	Applications and Characteristics	Category	Inductance	Tolerance	Features	Electrode	Packaging L:Taping *B:Bulk

*Bulk packing also available. (A product is put in the plastic bag under the taping conditions.)

3.Rating

- Operating Temperature Range. $-55^{\circ}\text{C} \sim +125^{\circ}\text{C}$ (includes self-heating)
- Storage Temperature Range. $-55^{\circ}\text{C} \sim +125^{\circ}\text{C}$

Customer Part Number	MURATA Part Number	Inductance		Q (min.)	DC Resistance (Ω max.)	Self Resonant Frequency (MHz min.)	*1,*2 Rated Current (mA)	
		(nH)	Tolerance					
	LQW2BAN3N2J00L	3.2	J : $\pm 5\%$	95	0.02	13800	3800	
	LQW2BAN3N6J00L	3.6		75	0.05	11800	2000	
	LQW2BAN6N8J00L	6.8		90	0.03	6200	3000	
	LQW2BAN7N5J00L	7.5		85	0.04	3900	2400	
	LQW2BAN8N2G00L	8.2	G : $\pm 2\%$ J : $\pm 5\%$	80	0.09	3200	1500	
	LQW2BAN8N2J00L					0.04	4700	2400
	LQW2BAN11NG00L	11			4300			
	LQW2BAN11NJ00L				12		3500	
	LQW2BAN12NG00L	13					70	0.12
	LQW2BAN12NJ00L							
	LQW2BAN13NG00L	15		85	0.05	3620	2200	
	LQW2BAN13NJ00L					2960		
	LQW2BAN15NG00L	18		0.07	1850	1850	1900	
	LQW2BAN15NJ00L							
	LQW2BAN18NG00L	20		75	0.15	1970	1400	
	LQW2BAN18NJ00L							
	LQW2BAN20NG00L	22		85	0.07	2750	2000	
	LQW2BAN20NJ00L							
	LQW2BAN22NG00L	24		80	0.08	2000	1500	
	LQW2BAN22NJ00L							
	LQW2BAN24NG00L	33	75	0.12	1900	1900		
	LQW2BAN24NJ00L							
	LQW2BAN27NG00L	36	0.08	1900	1900	1900		
	LQW2BAN27NJ00L							
	LQW2BAN30NG00L	39	75	0.12	1720	1550		
	LQW2BAN30NJ00L							
	LQW2BAN33NG00L	43	70	0.20	1500	1250		
	LQW2BAN33NJ00L							
	LQW2BAN36NG00L	47	0.08	1900	1900	1900		
	LQW2BAN36NJ00L							
	LQW2BAN39NG00L	43	75	0.12	1720	1550		
	LQW2BAN39NJ00L							
	LQW2BAN43NG00L	47	70	0.20	1500	1250		
	LQW2BAN43NJ00L							
	LQW2BAN47NG00L	47	0.08	1900	1900	1900		
	LQW2BAN47NJ00L							

Reference Only

Customer Part Number	MURATA Part Number	Inductance		Q (min.)	DC Resistance (Ω max.)	Self Resonant Frequency (MHz min.)	*1,*2 Rated Current (mA)
		(nH)	Tolerance				
	LQW2BAN51NG00L	51	G : ±2% J : ±5%	75	0.11	1100	1800
	LQW2BAN51NJ00L						
	LQW2BAN56NG00L	56		70	0.18	1600	1250
	LQW2BAN56NJ00L						
	LQW2BAN62NG00L	62		70	0.12	1470	1650
	LQW2BAN62NJ00L						
	LQW2BAN68NG00L	68		68	0.20	1450	1100
	LQW2BAN68NJ00L						
	LQW2BAN75NG00L	75		70	0.24	1330	1200
	LQW2BAN75NJ00L						
	LQW2BAN82NG00L	82		70	0.21	1140	1300
	LQW2BAN82NJ00L						
	LQW2BAN91NG00L	91		66	0.35	1200	1050
	LQW2BAN91NJ00L						
	LQW2BANR10G00L	100		57	0.38	1000	950
	LQW2BANR10J00L						
	LQW2BANR11G00L	110		56	0.42	920	930
	LQW2BANR11J00L						
	LQW2BANR12G00L	120		58	0.46	920	800
	LQW2BANR12J00L						
	LQW2BANR13G00L	130	53	0.58	920	750	
	LQW2BANR13J00L						
	LQW2BANR15G00L	150	56	0.42	1000	950	
	LQW2BANR15J00L						
	LQW2BANR16G00L	160	58	0.46	920	930	
	LQW2BANR16J00L						
	LQW2BANR18G00L	180	53	0.58	920	800	
	LQW2BANR18J00L						
	LQW2BANR20G00L	200	53	0.63	920	750	
	LQW2BANR20J00L						

*1 Derating of rated current shown by Figure 1 should be applied.

*2: When applied Rated current to the Products, self temperature rise shall be limited to 40°C max..

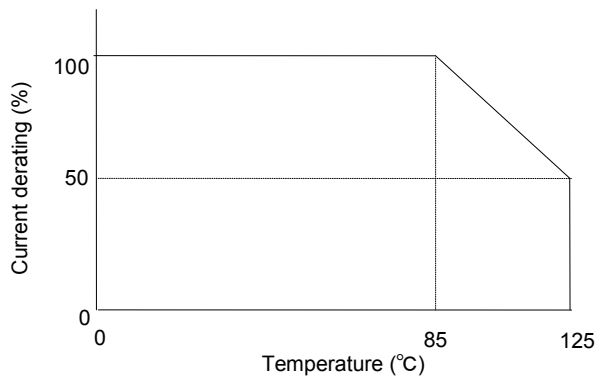

Figure 1. Derating curve

4. Testing Conditions

《Unless otherwise specified》

Temperature : Ordinary Temperature / 15°C to 35°C
 Humidity : Ordinary Humidity / 25%(RH) to 85%(RH)

《In case of doubt》

Temperature : 20°C±2°C
 Humidity : 60%(RH) to 70%(RH)
 Atmospheric Pressure : 86kPa to 106 kPa

5. Appearance and Dimensions

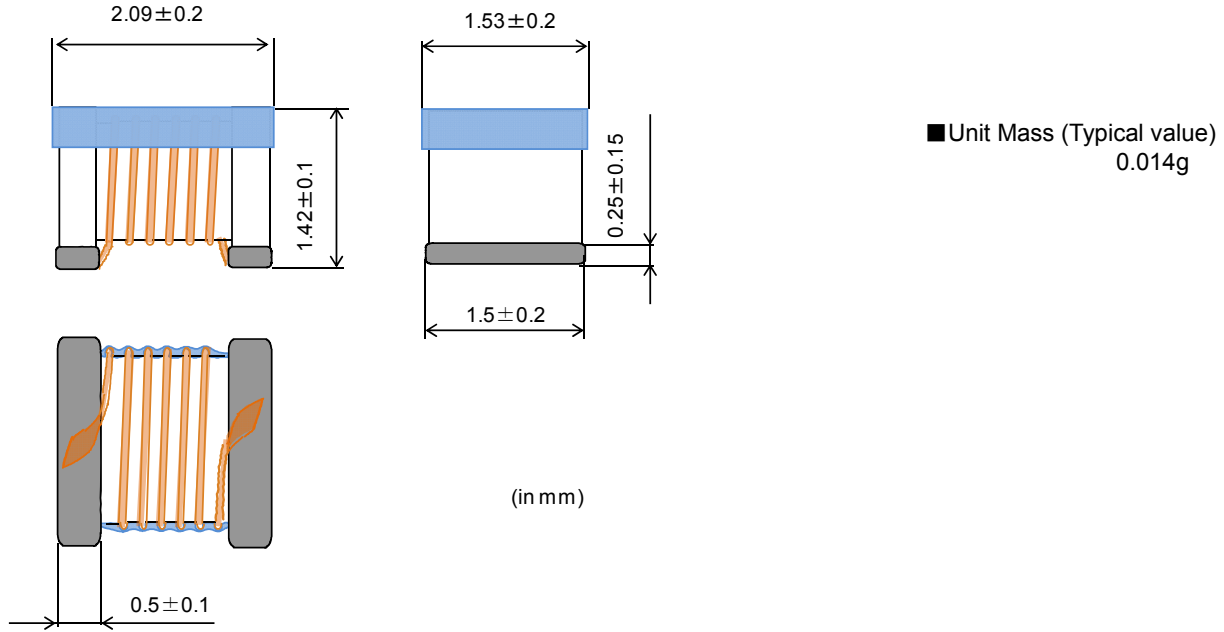

6. Electrical Performance

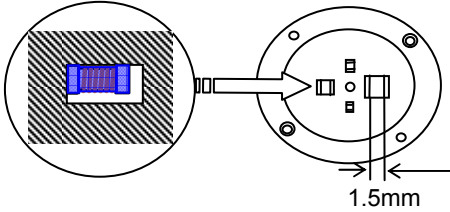
No.	Item	Specification	Test Method
6.1	Inductance	Inductance shall meet item 3.	Measuring Equipment: KEYSIGHT 4287A or equivalent Measuring Frequency: <Inductance> 250MHz/3.2nH~39nH 200MHz/43nH~75nH 150MHz/82nH~130nH 100MHz/150nH~200nH <Q> 1500MHz/3.2nH,3.6nH 1000MHz/6.8nH~8.2nH 500MHz/11nH~100nH 250MHz/110nH~200nH Measuring Condition: Test signal level / about 0dBm Electrode spaces / 1.5 mm Electrical length / 10.0mm Measuring Fixture: KEYSIGHT 16197A Position coil under test as shown in below and contact coil with each terminal by adding weight.  Measuring Method: See the endnote. <Electrical Performance: Measuring Method of Inductance/Q>
6.2	Q	Q shall meet item 3.	
6.3	DC Resistance	DC Resistance shall meet item 3.	Measuring Equipment: Digital multi meter
6.4	Self Resonant Frequency(SRF)	S.R.F shall meet item 3.	Measuring Equipment: KEYSIGHT 8753C or equivalent

Reference Only

7.Mechanical Performance

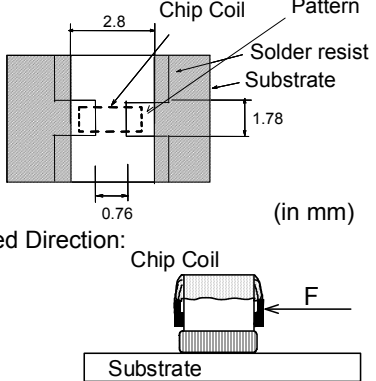
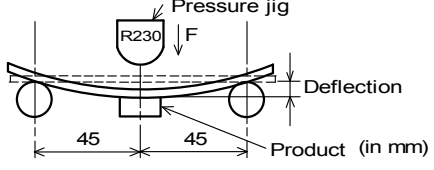
No.	Item	Specification	Test Method
7.1	Shear Test	Chip coil shall not be damaged after tested as test method.	<p>Substrate:Glass-epoxy substrate</p>  <p>Applied Direction:</p> <p>Force:10N Hold Duration:5s±1s</p>
7.2	Bending Test		<p>Substrate:Glass-epoxy substrate (100mm×40mm×1.0mm)</p> <p>Speed of Applying Force:1mm / s Deflection:3mm Hold Duration:5s</p> 
7.3	Vibration		<p>Oscillation Frequency: 10Hz~2000Hz~10Hz for 15 min Total amplitude 3 mm or Acceleration amplitude 196m/s² whichever is smaller. Time : A period of 2 hours in each of 3 mutually perpendicular directions. (Total 6hours)</p>
7.4	Solderability	The wetting area of the electrode shall be at least 90% covered with new solder coating.	<p>Flux:Ethanol solution of rosin,25(wt)% Includes activator equivalent to 0.06(wt)% chlorine.(immersed for 5s to 10s) Solder:Sn-3.0Ag-0.5Cu Pre-Heating:150°C±10°C / 60s to 90s Solder Temperature:240°C±5°C Immersion Time:3s±1s</p>
7.5	Resistance to Soldering Heat	Appearance:No damage Inductance Change: within ±5%	<p>Flux:Ethanol solution of rosin,25(wt)% Includes activator equivalent to 0.06(wt)% Chlorine.(immersed for 5s to 10s) Solder:Sn-3.0Ag-0.5Cu Pre-Heating:150°C±10°C / 60s to 90s Solder Temperature:270°C±5°C Immersion Time:10s±1s Then measured after exposure in the room condition for 24h±2h.</p>

8. Environmental Performance

It shall be soldered on the substrate.

No.	Item	Specification	Test Method
8.1	Heat Resistance	Appearance: No damage Inductance Change: within $\pm 5\%$ Q Change: within $\pm 20\%$	Temperature: $125^{\circ}\text{C} \pm 2^{\circ}\text{C}$ Time: 1000h (+48h, 0h) Then measured after exposure in the room condition for 24h ± 2 h.
8.2	Cold Resistance		Temperature: $-55^{\circ}\text{C} \pm 2^{\circ}\text{C}$ Time: 1000h (+48h, -0h) Then measured after exposure in the room condition for 24 ± 2 h.
8.3	Humidity		Temperature: $85^{\circ}\text{C} \pm 2^{\circ}\text{C}$ Humidity: 85%(RH) Time: 1000h (+48h, -0h) Then measured after exposure in the room condition for 24h ± 2 h.
8.4	Temperature Cycle		1 cycle: 1 step: $-55^{\circ}\text{C} \pm 2^{\circ}\text{C}$ / 30min ± 3 min 2 step: Ordinary temp. / 10min to 15 min 3 step: $+125^{\circ}\text{C} \pm 2^{\circ}\text{C}$ / 30min ± 3 min 4 step: Ordinary temp. / 30min ± 3 min Total of 10 cycles Then measured after exposure in the room condition for 24h ± 2 h.

9. Specification of Packaging

9.1 Appearance and Dimensions of plastic tape (8mm-wide, 4mm-pitch)

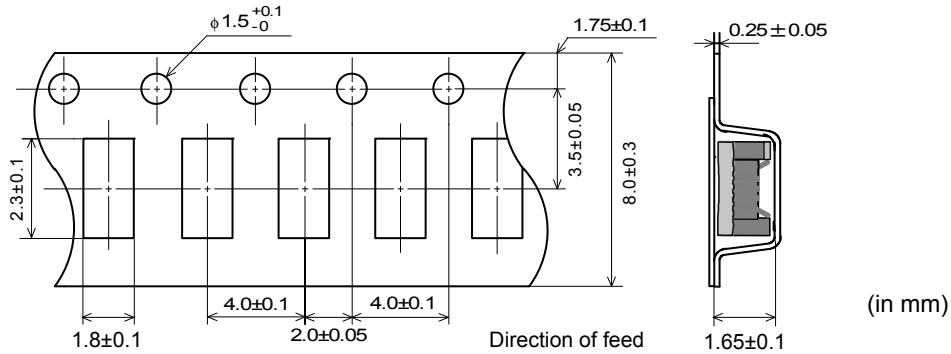

• Dimension of the Cavity is measured at the bottom side.

9.2 Specification of Taping

- (1) Packing quantity (standard quantity)
2,000 pcs. / reel
- (2) Packing Method
Products shall be packed in the cavity of the plastic tape and sealed by Cover tape.
- (3) Sprocket hole
The sprocket holes are to the right as the tape is pulled toward the user.
- (4) Spliced point
Plastic tape and Cover tape has no spliced point.
- (5) Missing components number
Missing components number within 0.1% of the number per reel or 1 pc., whichever is greater, and are not continuous. The Specified quantity per reel is kept.

9.3 Pull Strength

Plastic tape	5N min.
Cover tape	10N min.

Reference Only

9.4 Peeling off force of cover tape

Speed of Peeling off	300mm/min
Peeling off force	0.1N to 0.6N (minimum value is typical)

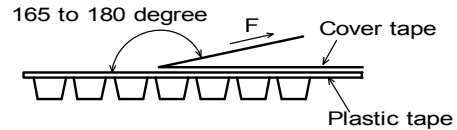

9.5 Dimensions of Leader-tape, Trailer and Reel

There shall be leader-tape (cover tape and empty tape) and trailer-tape (empty tape) as follows.

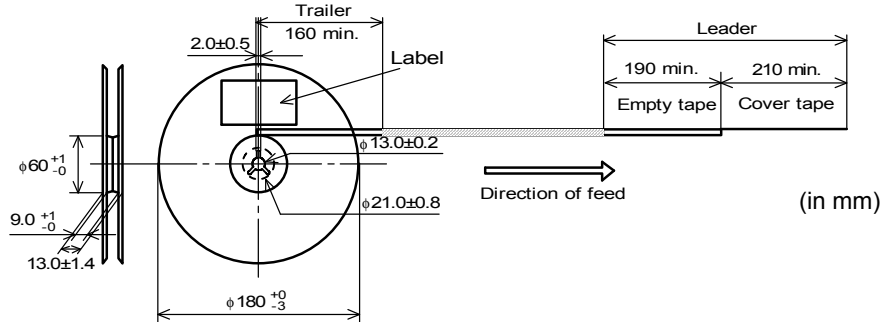

9.6 Marking for reel

Customer part number, MURATA part number, Inspection number(•1) , RoHS Marking (•2), Quantity etc ...

•1) <Expression of Inspection No.>

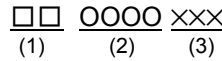

(1) Factory Code

(2) Date First digit : Year / Last digit of year

Second digit : Month / Jan. to Sep. • 1 to 9, Oct. to Dec. • O, N, D

Third, Fourth digit : Day

(3) Serial No.

•2) <Expression of RoHS Marking >

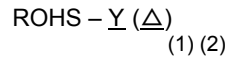

(1) RoHS regulation conformity parts.

(2) MURATA classification number

9.7 Marking for Outside package (corrugated paper box)

Customer name, Purchasing order number, Customer part number, MURATA part number, RoHS Marking (•2) ,Quantity, etc ...

9.8. Specification of Outer Case

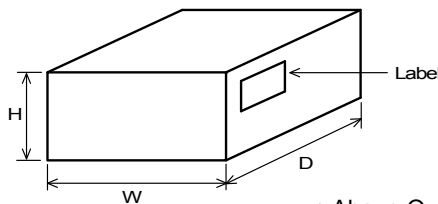

Outer Case Dimensions (mm)			Standard Reel Quantity in Outer Case (Reel)
W	D	H	
186	186	93	5

* Above Outer Case size is typical. It depends on a quantity of an order.

10. ⚠ Caution

Limitation of Applications

Please contact us before using our products for the applications listed below which require especially high reliability for the prevention of defects which might directly cause damage to the third party's life, body or property.

- | | |
|-----------------------------------|--|
| (1) Aircraft equipment | (6) Transportation equipment (vehicles, trains, ships, etc.) |
| (2) Aerospace equipment | (7) Traffic signal equipment |
| (3) Undersea equipment | (8) Disaster prevention / crime prevention equipment |
| (4) Power plant control equipment | (9) Data-processing equipment |
| (5) Medical equipment | (10) Applications of similar complexity and /or reliability requirements to the applications listed in the above |

11. Notice

Products can only be soldered with reflow.
 This product is designed for solder mounting.
 Please consult us in advance for applying other mounting method such as conductive adhesive.

11.1 Land pattern designing

Recommended land patterns for reflow soldering are as follows:
 These have been designed for Electric characteristics and solderability.
 Please follow the recommended patterns. Otherwise, their performance which includes electrical performance or solderability may be affected, or result to "position shift" in soldering process.

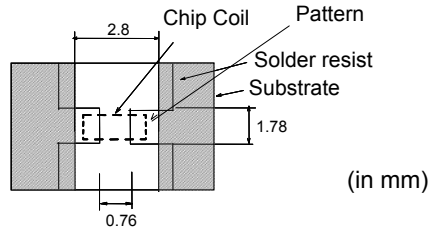

11.2 Flux, Solder

- Use rosin-based flux.
 Includes middle activator equivalent to 0.06(wt)% to 0.1(wt) % Chlorine.
 Don't use highly acidic flux with halide content exceeding 0.2(wt) % (chlorine conversion value).
 Don't use water-soluble flux.
- Use Sn-3.0Ag-0.5Cu solder.
- Standard thickness of solder paste : 100µm to 150µm.

11.3 Reflow soldering conditions

- Pre-heating should be in such a way that the temperature difference between solder and product surface is limited to 150°C max. Cooling into solvent after soldering also should be in such a way that the temperature difference is limited to 100°C max.
 Insufficient pre-heating may cause cracks on the product, resulting in the deterioration of products quality.
- Standard soldering profile and the limit soldering profile is as follows.
 The excessive limit soldering conditions may cause leaching of the electrode and / or resulting in the deterioration of product quality.
- Reflow soldering profile

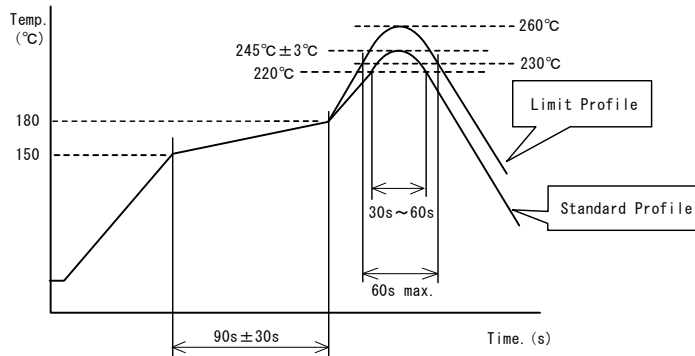

	Standard Profile	Limit Profile
Pre-heating	150°C ~ 180°C , 90s ± 30s	
Heating	above 220°C, 30s ~ 60s	above 230°C, 60s max.
Peak temperature	245°C ± 3°C	260°C, 10s
Cycle of reflow	2 times	

11.4 Reworking with soldering iron.

The following conditions must be strictly followed when using a soldering iron.

Pre-heating	150°C, 1 min
Tip temperature	350°C max.
Soldering iron output	80W max.
Tip diameter	Φ·3mm max.
Soldering time	3(+1,-0)s
Times	2 times

Note : Do not directly touch the products with the tip of the soldering iron in order to prevent the crack on the products due to the thermal shock.

11.5 Solder Volume

- Solder shall be used not to be exceed the upper limits as shown below.
- Accordingly increasing the solder volume, the mechanical stress to Chip is also increased. Exceeding solder volume may cause the failure of mechanical or electrical performance.

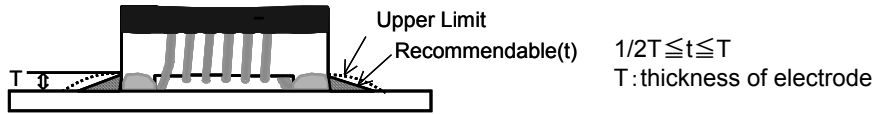

11.6 Product's location

The following shall be considered when designing and laying out P.C.B.'s.

- (1) P.C.B. shall be designed so that products are not subject to the mechanical stress due to warping the board.

[Products direction]

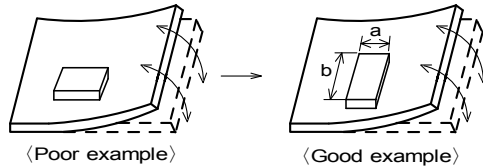

Products shall be located in the sideways direction (Length: $a < b$) to the mechanical stress.

- (2) Components location on P.C.B. separation.

It is effective to implement the following measures, to reduce stress in separating the board.

It is best to implement all of the following three measures; however, implement as many measures as possible to reduce stress.

Contents of Measures	Stress Level
(1) Turn the mounting direction of the component parallel to the board separation surface.	A > D *1
(2) Add slits in the board separation part.	A > B
(3) Keep the mounting position of the component away from the board separation surface.	A > C

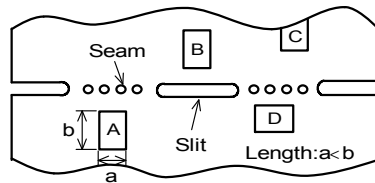

*1 A > D is valid when stress is added vertically to the perforation as with Hand Separation. If a Cutting Disc is used, stress will be diagonal to the PCB, therefore A > D is invalid.

(3) Mounting Components Near Screw Holes

When a component is mounted near a screw hole, it may be affected by the board deflection that occurs during the tightening of the screw. Mount the component in a position as far away from the screw holes as possible.

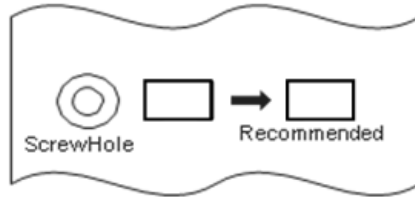

11.7 Cleaning Conditions

Products shall be cleaned on the following conditions.

- (1) Cleaning temperature shall be limited to 60°C max. (40°C max for IPA)
- (2) Ultrasonic cleaning shall comply with the following conditions with avoiding the resonance phenomenon at the mounted products and P.C.B.
Power : 20 W / l max. Frequency : 28kHz to 40kHz Time : 5 min max.
- (3) Cleaner
 1. Alcohol type cleaner
Isopropyl alcohol (IPA)
 2. Aqueous agent
PINE ALPHA ST-100S
- (4) There shall be no residual flux and residual cleaner after cleaning.
In the case of using aqueous agent, products shall be dried completely after rinse with de-ionized water in order to remove the cleaner.
- (5) Other cleaning Please contact us.

11.8 Resin coating

The inductance value may change due to high cure-stress of resin to be used for coating/molding products. An open circuit issue may occur by mechanical stress caused by the resin, amount/cured shape of resin, or operating condition etc. Some resin contains some impurities or chloride possible to generate chlorine by hydrolysis under some operating condition may cause corrosion of wire of coil, leading to open circuit. So, please pay your careful attention when you select resin in case of coating/molding the products with the resin. Prior to use the coating resin, please make sure no reliability issue is observed by evaluating products mounted on your board.

11.9 Caution for use

- Sharp material such as a pair of tweezers or other material such as bristles of cleaning brush, shall not be touched to the winding portion to prevent the breaking of wire.
- Mechanical shock should not be applied to the products mounted on the board to prevent the breaking of the core.

11.10 Notice of product handling at mounting

In some mounting machines, when picking up components support pin pushes up the components from the bottom of plastic tape. In this case, please remove the support pin. The support pin may damage the components and break wire.

11.11 Handling of a substrate

After mounting products on a substrate, do not apply any stress to the product caused by bending or twisting to the substrate when cropping the substrate, inserting and removing a connector from the substrate or tightening screw to the substrate.

Excessive mechanical stress may cause cracking in the product.

Bending

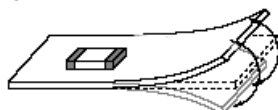

Twisting

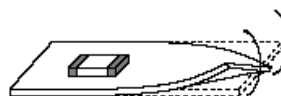

11.12 Storage and Handling Requirements

(1) Storage period

Use the products within 12 months after delivered.

Solderability should be checked if this period is exceeded.

(2) Storage conditions

• Products should be stored in the warehouse on the following conditions.

Temperature : -10°C to 40°C

Humidity : 15% to 85% relative humidity No rapid change on temperature and humidity

• Don't keep products in corrosive gases such as sulfur, chlorine gas or acid, or it may cause oxidization of electrode, resulting in poor solderability.

• Products should not be stored on bulk packaging condition to prevent the chipping of the core and the breaking of winding wire caused by the collision between the products.

• Products should be stored on the palette for the prevention of the influence from humidity, dust and so on.

• Products should be stored in the warehouse without heat shock, vibration, direct sunlight and so on.

(3) Handling Condition

Care should be taken when transporting or handling product to avoid excessive vibration or mechanical shock.

12. Note

(1) Please make sure that your product has been evaluated in view of your specifications with our product being mounted to your product.

(2) You are requested not to use our product deviating from the reference specifications.

(3) The contents of this reference specification are subject to change without advance notice.

Please approve our product specifications or transact the approval sheet for product specifications before ordering.

<Electrical Performance: Measuring Method of Inductance/Q>

(1) Residual elements and stray elements of test fixture can be described by F-parameter shown in following.

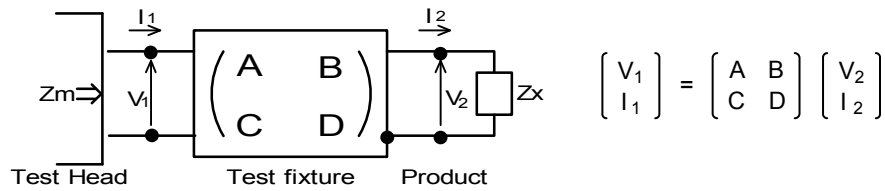

(2) The impedance of chip coil Z_x and measured value Z_m can be described by input/output current/voltage.

$$Z_m = \frac{V_1}{I_1}, \quad Z_x = \frac{V_2}{I_2}$$

(3) Thus, the relation between Z_x and Z_m is following;

$$Z_x = \alpha \frac{Z_m - \beta}{1 - Z_m \Gamma} \quad \text{where, } \alpha = D / A = 1$$

$$\beta = B / D = Z_{sm} - (1 - Y_{om}) Z_{ss}$$

$$\Gamma = C / A = Y_{om}$$

- [Z_{sm} : measured impedance of short chip
- [Z_{ss} : residual impedance of short chip (0.771nH)
- [Y_{om} : measured admittance when opening the fixture

(4) L_x shall be calculated with the following equation.

$$L_x = \frac{\text{Im}(Z_x)}{2\pi f}, \quad Q_x = \frac{\text{Im}(Z_x)}{\text{Re}(Z_x)}$$

L_x : Inductance of chip coil
 Q_x : Q of chip coil
 f : Measuring frequency