

EPC2039 – Enhancement Mode Power Transistor

 $V_{DSS}, 80\text{ V}$ $R_{DS(on)}, 25\text{ m}\Omega$ $I_D, 6.8\text{ A}$ 

Gallium Nitride is grown on Silicon Wafers and processed using standard CMOS equipment leveraging the infrastructure that has been developed over the last 60 years. GaN's exceptionally high electron mobility and low temperature coefficient allows very low $R_{DS(on)}$, while its lateral device structure and majority carrier diode provide exceptionally low Q_G and zero Q_{RR} . The end result is a device that can handle tasks where very high switching frequency, and low on-time are beneficial as well as those where on-state losses dominate.

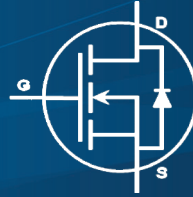
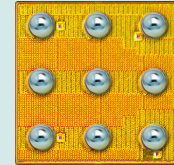

EPC2039 eGaN® FETs are supplied only in passivated die form with solder bumps
Die Size: 1.35 mm x 1.35 mm

Applications

- High Speed DC-DC conversion
- Wireless Power Transfer
- LiDAR/Pulsed Power Applications

Benefits

- Ultra High Efficiency
- Ultra Low $R_{DS(on)}$
- Ultra low Q_G
- Ultra small footprint

www.epc-co.com/epc/Products/eGaNfets/EPC2039.aspx

Maximum Ratings

Maximum Ratings			
V_{DS}	Drain-to-Source Voltage (Continuous)	80	V
	Drain-to-Source Voltage (up to 10,000 5ms pulses at 150°C)	96	
I_D	Continuous ($T_A = 25^\circ\text{C}$, $R_{\theta JA} = 70^\circ\text{C/W}$)	6.8	A
	Pulsed (25°C , $T_{PULSE} = 300\ \mu\text{s}$)	50	
V_{GS}	Gate-to-Source Voltage	6	V
	Gate-to-Source Voltage	-4	
T_J	Operating Temperature	-40 to 150	°C
T_{STG}	Storage Temperature	-40 to 150	

Static Characteristics ($T_J = 25^\circ\text{C}$ unless otherwise stated)

PARAMETER	TEST CONDITIONS	MIN	TYP	MAX	UNIT	
BV_{DSS}	Drain-to-Source Voltage	$V_{GS} = 0\text{ V}$, $I_D = 300\ \mu\text{A}$	80		V	
I_{DSS}	Drain Source Leakage	$V_{DS} = 64\text{ V}$, $V_{GS} = 0\text{ V}$		20	250	μA
I_{GSS}	Gate-to-Source Forward Leakage	$V_{GS} = 5\text{ V}$		0.2	2	mA
	Gate-to-Source Reverse Leakage	$V_{GS} = -4\text{ V}$		20	250	μA
$V_{GS(TH)}$	Gate Threshold Voltage	$V_{DS} = V_{GS}$, $I_D = 2\text{ mA}$	0.8	1.6	2.5	V
$R_{DS(on)}$	Drain-Source On Resistance	$V_{GS} = 5\text{ V}$, $I_D = 6\text{ A}$		20	25	m Ω
V_{SD}	Source-Drain Forward Voltage	$I_S = 0.5\text{ A}$, $V_{GS} = 0\text{ V}$		2.5		V

All measurements were done with substrate shorted to source.

Thermal Characteristics

		TYP	UNIT
$R_{\theta JC}$	Thermal Resistance, Junction to Case	3	°C/W
$R_{\theta JB}$	Thermal Resistance, Junction to Board	28	°C/W
$R_{\theta JA}$	Thermal Resistance, Junction to Ambient (Note 1)	81	°C/W

Note 1: $R_{\theta JA}$ is determined with the device mounted on one square inch of copper pad, single layer 2 oz copper on FR4 board.
See http://epc-co.com/epc/documents/product-training/Appnote_Thermal_Performance_of_eGaN_FETs.pdf for details.

Dynamic Characteristics (T _J = 25°C unless otherwise stated)						
PARAMETER		TEST CONDITIONS	MIN	TYP	MAX	UNIT
C _{ISS}	Input Capacitance	V _{DS} = 40 V, V _{GS} = 0 V		210	260	pF
C _{RSS}	Reverse Transfer Capacitance			2		
C _{OSS}	Output Capacitance			115	175	
C _{OSS(ER)}	Effective Output Capacitance, Energy Related (Note 2)	V _{DS} = 0 to 100 V, V _{GS} = 0 V		155		
C _{OSS(TR)}	Effective Output Capacitance, Time Related (Note 3)			190		
R _G	Gate Resistance			0.5		Ω
Q _G	Total Gate Charge	V _{DS} = 40 V, V _{GS} = 5 V, I _D = 6 A		1910	2370	pC
Q _{GS}	Gate-to-Source Charge	V _{DS} = 40 V, I _D = 6 A		760		
Q _{GD}	Gate-to-Drain Charge			420		
Q _{G(TH)}	Gate Charge at Threshold			560		
Q _{OSS}	Output Charge		V _{DS} = 40 V, V _{GS} = 0 V		7640	
Q _{RR}	Source-Drain Recovery Charge			0		

Note 2: C_{OSS(ER)} is a fixed capacitance that gives the same stored energy as C_{OSS} while V_{DS} is rising from 0 to 50% BV_{DSS}.
 Note 3: C_{OSS(TR)} is a fixed capacitance that gives the same charging time as C_{OSS} while V_{DS} is rising from 0 to 50% BV_{DSS}.

Figure 1: Typical Output Characteristics at 25°C

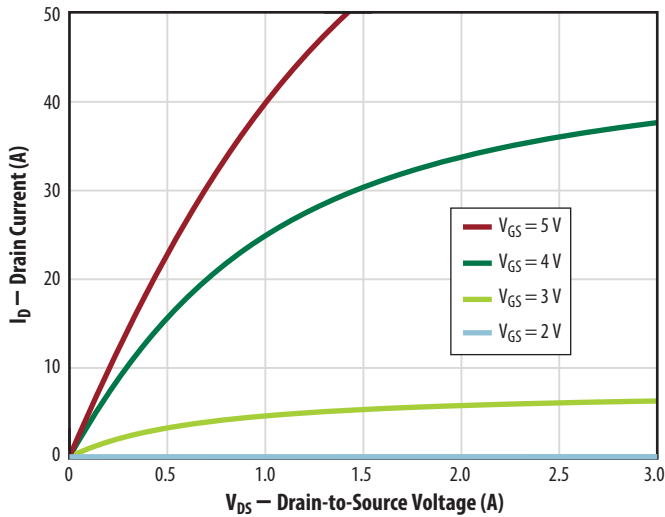

Figure 2: Transfer Characteristics

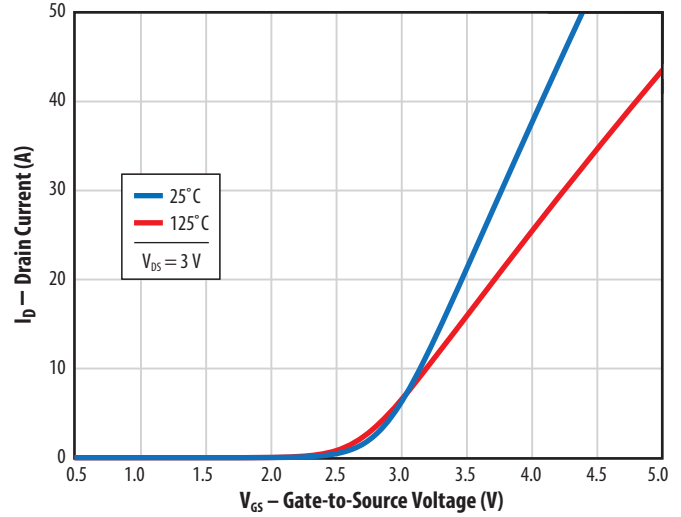

Figure 3: R_{DS(on)} vs. V_{GS} for Various Drain Currents

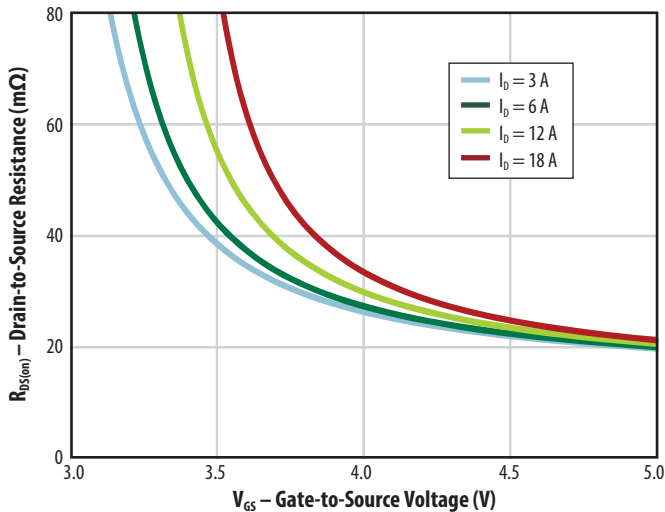

Figure 4: R_{DS(on)} vs. V_{GS} for Various Temperatures

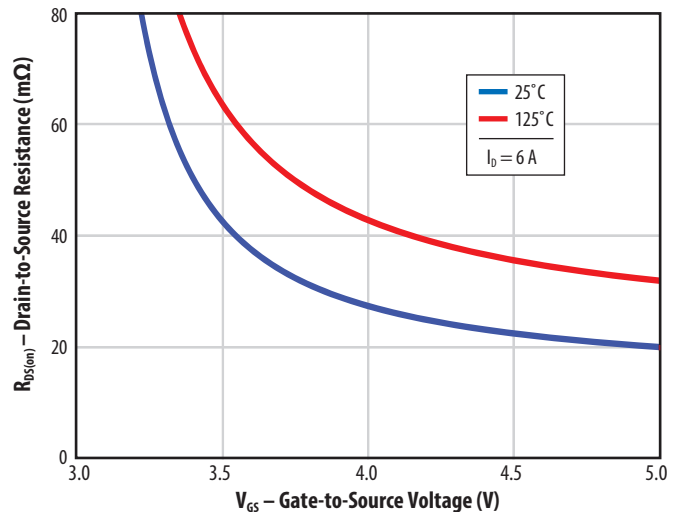

Figure 5a: Capacitance (Linear Scale)

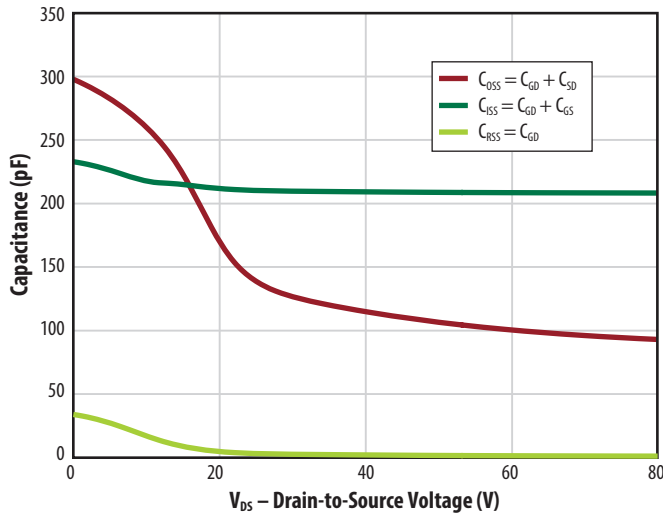

Figure 5b: Capacitance (Log Scale)

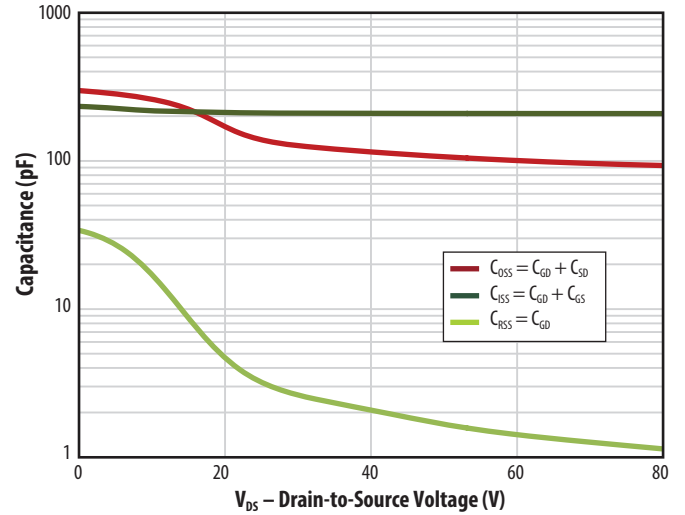

Figure 6: Gate Charge

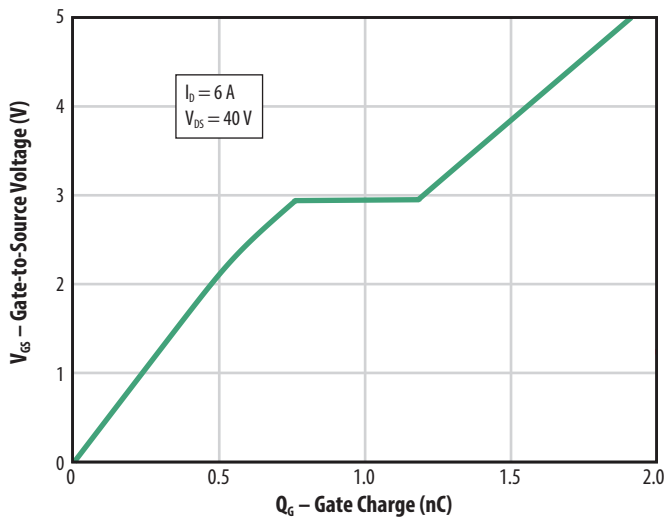

Figure 7: Reverse Drain-Source Characteristics

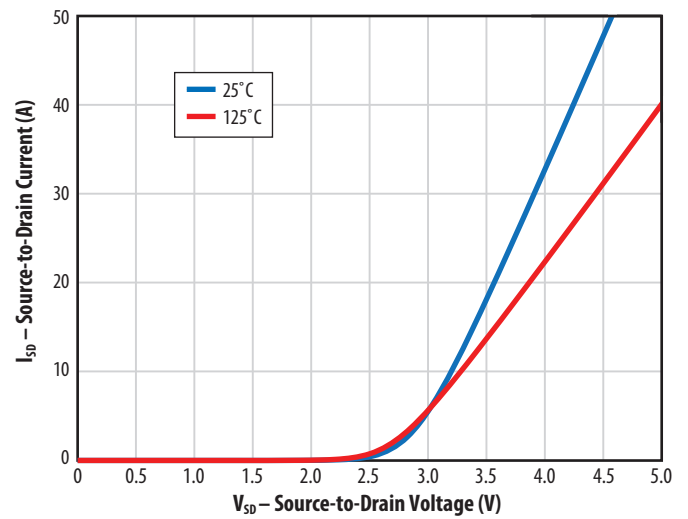

Figure 8: Normalized On Resistance vs. Temperature

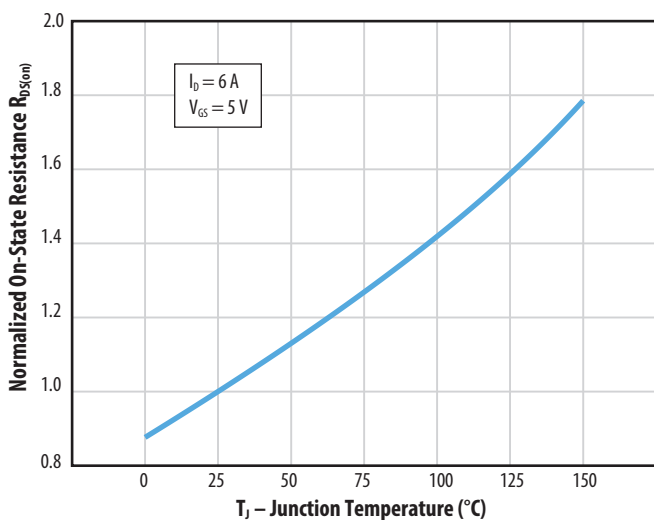
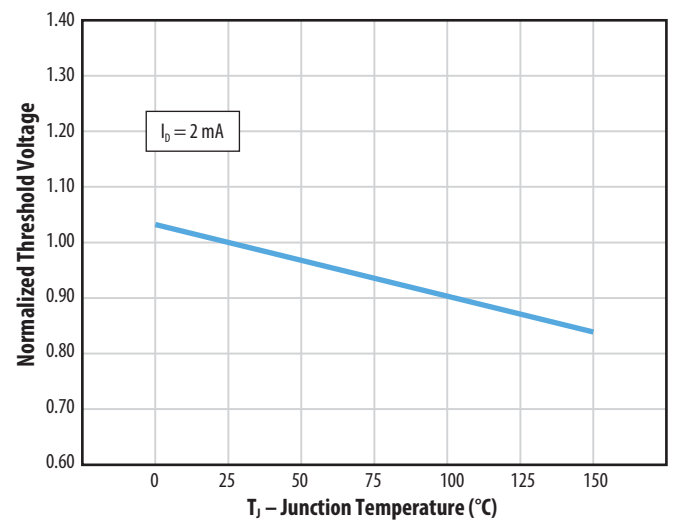

Figure 9: Normalized Threshold Voltage vs. Temperature



All measurements were done with substrate shorted to source.

Figure 10: Transient Thermal Response Curves

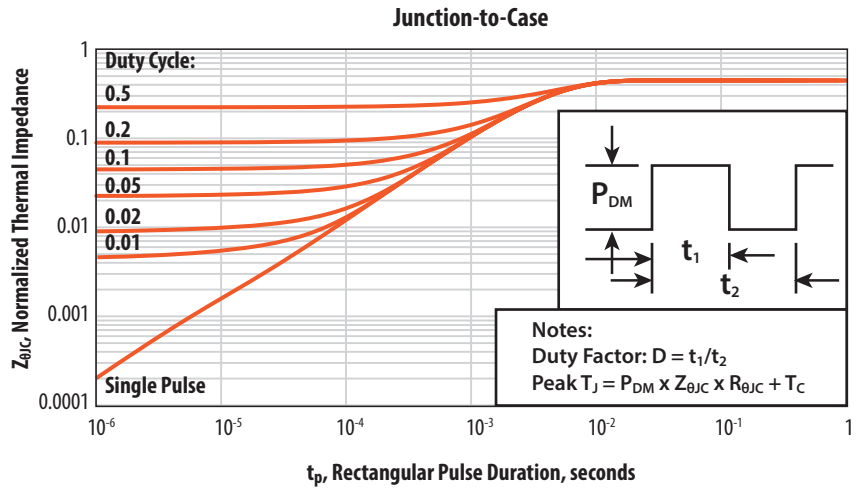
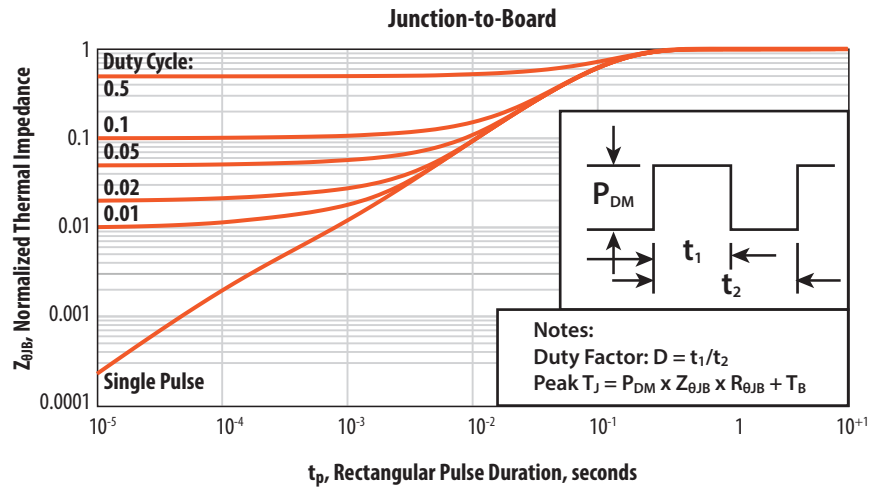
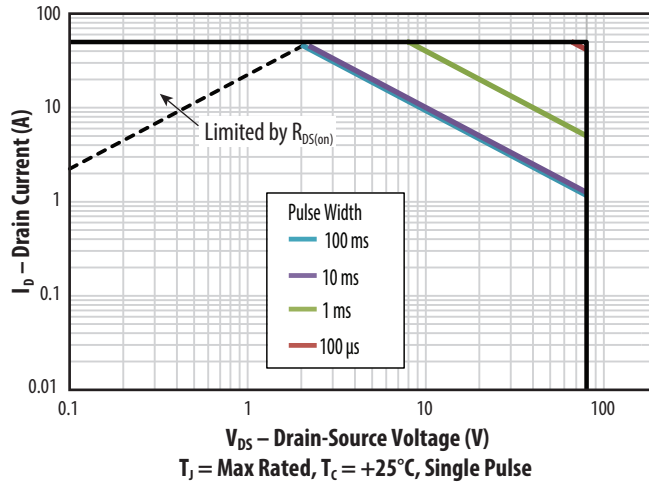
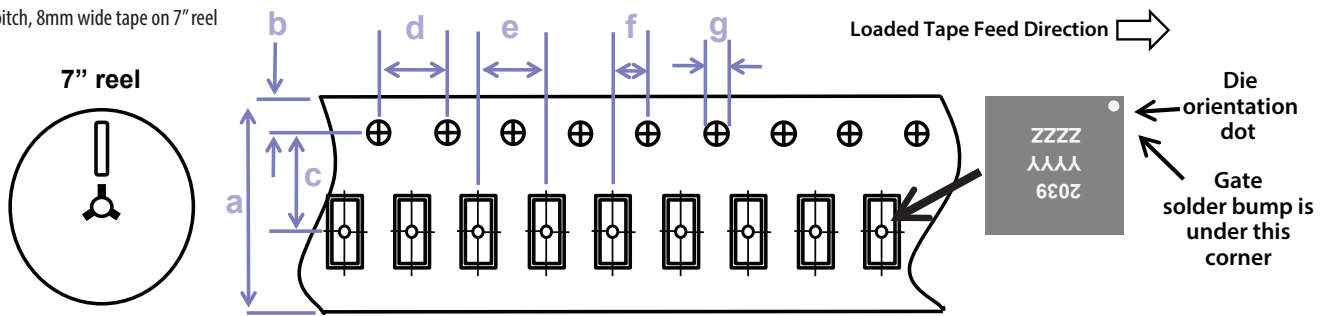

Figure 11: Safe Operating Area



TAPE AND REEL CONFIGURATION

4mm pitch, 8mm wide tape on 7" reel



Dimension (mm)	EPC2039 (note 1)		
	target	min	max
a	8.00	7.90	8.30
b	1.75	1.65	1.85
c (see note)	3.50	3.45	3.55
d	4.00	3.90	4.10
e	4.00	3.90	4.10
f (see note)	2.00	1.95	2.05
g	1.5	1.5	1.6

Note 1: MSL 1 (moisture sensitivity level 1) classified according to IPC/JEDEC industry standard.
 Note 2: Pocket position is relative to the sprocket hole measured as true position of the pocket, not the pocket hole.

DIE MARKINGS

Die orientation dot

Gate Pad bump is under this corner

Part Number	Laser Markings		
	Part # Marking Line 1	Lot_Date Code Marking Line 2	Lot_Date Code Marking Line 3
EPC2039	AA	YYYY	ZZZZ

DIE OUTLINE

Solder Bump View

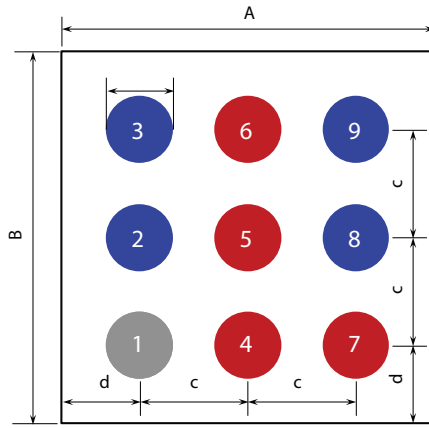

DIM	MIN	Nominal	MAX
A	1320	1350	1380
B	1320	1350	1380
c	450	450	450
d	210	225	240
e	187	208	229

Pad 1 is Gate;
Pads 4, 5, 6, 7 are Drain;
Pads 2, 3, 8, 9 are Source

Side View

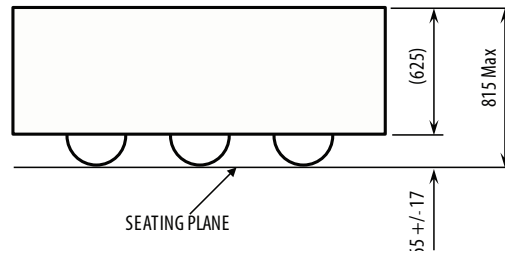

RECOMMENDED LAND PATTERN

(measurements in μm)

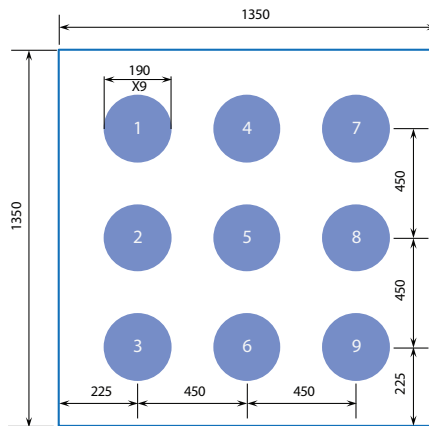

The land pattern is solder mask defined
Solder mask is 10 μm smaller per side than bump

Pad 1 is Gate;
Pads 4, 5, 6, 7 are Drain;
Pads 2, 3, 8, 9 are Source

RECOMMENDED STENCIL DRAWING

(measurements in μm)

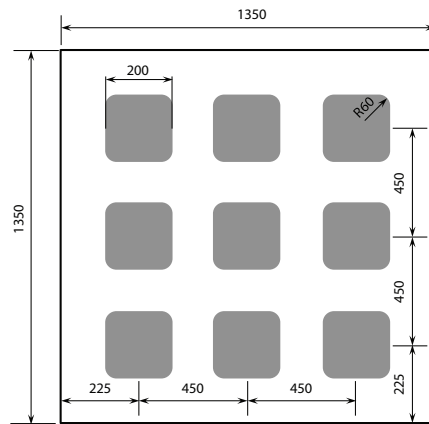

Recommended stencil should be 4mil (100 μm) thick, must be laser cut, openings per drawing.

Intended for use with SAC305 Type 4 solder, reference 88.5% metals content.

Additional assembly resources available at
<http://epc-co.com/epc/DesignSupport/AssemblyBasics.aspx>

Efficient Power Conversion Corporation (EPC) reserves the right to make changes without further notice to any products herein to improve reliability, function or design. EPC does not assume any liability arising out of the application or use of any product or circuit described herein; neither does it convey any license under its patent rights, nor the rights of others.

eGaN® is a registered trademark of Efficient Power Conversion Corporation.
EPC Patent Listing: epc-co.com/epc/AboutEPC/Patents.aspx

Information subject to change without notice.

Revised April, 2017