

PNP SMALL SIGNAL SILICON TRANSISTOR

Qualified per MIL-PRF-19500/291

DEVICES

2N2906A	2N2907A
2N2906AL	2N2907AL
2N2906AUA	2N2907AUA
2N2906AUB	2N2907AUB
2N2906AUBC *	2N2907AUBC *

* Available to JANS quality level only.

LEVELS

JAN
JANTX
JANTXV
JANS

ABSOLUTE MAXIMUM RATINGS ($T_C = +25^\circ\text{C}$ unless otherwise noted)

Parameters / Test Conditions	Symbol	Value	Unit
Collector-Emitter Voltage	V_{CEO}	60	Vdc
Collector-Base Voltage	V_{CBO}	60	Vdc
Emitter-Base Voltage	V_{EBO}	5.0	Vdc
Collector Current	I_C	600	mAdc
Total Power Dissipation @ $T_A = +25^\circ\text{C}$	P_T	0.5	W
Operating & Storage Junction Temperature Range	T_{op}, T_{stg}	-65 to +200	$^\circ\text{C}$

Note: Consult 19500/291 for Thermal Performance Curves.

ELECTRICAL CHARACTERISTICS ($T_A = +25^\circ\text{C}$, unless otherwise noted)

Parameters / Test Conditions	Symbol	Min.	Max.	Unit
OFF CHARACTERISTICS				
Collector-Emitter Breakdown Voltage $I_C = 10\text{mAdc}$	$V_{(BR)CEO}$	60		Vdc
Collector-Base Cutoff Current $V_{CB} = 60\text{Vdc}$ $V_{CB} = 50\text{Vdc}$	I_{CBO}		10 10	μAdc ηAdc
Emitter-Base Cutoff Current $V_{EB} = 4.0\text{Vdc}$ $V_{EB} = 5.0\text{Vdc}$	I_{EBO}		50 10	ηAdc μAdc
Collector-Emitter Cutoff Current $V_{CE} = 50\text{Vdc}$	I_{CES}		50	ηAdc

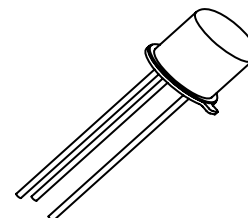

TO-18 (TO-206AA)
2N2906A, 2N2907A

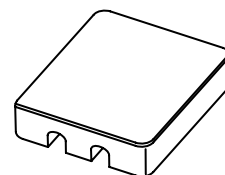

4 PIN
2N2906AUA, 2N2907AUA

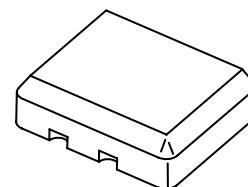

3 PIN
2N2906AUB, 2N2907AUB
2N2906AUBC, 2N2907AUBC
 (UBC = Ceramic Lid Version)

ELECTRICAL CHARACTERISTICS ($T_A = +25^\circ\text{C}$, unless otherwise noted)

Parameters / Test Conditions	Symbol	Min.	Max.	Unit
ON CHARACTERISTICS ⁽⁴⁾				
Forward-Current Transfer Ratio $I_C = 0.1\text{mA}$, $V_{CE} = 10\text{Vdc}$	2N2906A, L, UA, UB, UBC 2N2907A, L, UA, UB, UBC	40 75		
$I_C = 1.0\text{mA}$, $V_{CE} = 10\text{Vdc}$	2N2906A, L, UA, UB, UBC 2N2907A, L, UA, UB, UBC	40 100	175 450	
$I_C = 10\text{mA}$, $V_{CE} = 10\text{Vdc}$	2N2906A, L, UA, UB, UBC 2N2907A, L, UA, UB, UBC	40 100		
$I_C = 150\text{mA}$, $V_{CE} = 10\text{Vdc}$	2N2906A, L, UA, UB, UBC 2N2907A, L, UA, UB, UBC	40 100	120 300	
$I_C = 500\text{mA}$, $V_{CE} = 10\text{Vdc}$	2N2906A, L, UA, UB, UBC 2N2907A, L, UA, UB, UBC	40 50		
Collector-Emitter Saturation Voltage $I_C = 150\text{mA}$, $I_B = 15\text{mA}$ $I_C = 500\text{mA}$, $I_B = 50\text{mA}$	$V_{CE(sat)}$		0.4 1.6	Vdc
Base-Emitter Saturation Voltage $I_C = 150\text{mA}$, $I_B = 15\text{mA}$ $I_C = 500\text{mA}$, $I_B = 50\text{mA}$	$V_{BE(sat)}$	0.6	1.3 2.6	Vdc

DYNAMIC CHARACTERISTICS

Parameters / Test Conditions	Symbol	Min.	Max.	Unit
Forward Current Transfer Ratio $I_C = 1.0\text{mA}$, $V_{CE} = 10\text{Vdc}$, $f = 1.0\text{kHz}$	2N2906A, L, UA, UB, UBC 2N2907A, L, UA, UB, UBC	40 100		
Magnitude of Small-Signal Forward Current Transfer Ratio $I_C = 20\text{mA}$, $V_{CE} = 20\text{Vdc}$, $f = 100\text{MHz}$	$ h_{fe} $	2.0		
Output Capacitance $V_{CB} = 10\text{Vdc}$, $I_E = 0$, $100\text{kHz} \leq f \leq 1.0\text{MHz}$	C_{obo}		8.0	pF
Input Capacitance $V_{EB} = 2.0\text{Vdc}$, $I_C = 0$, $100\text{kHz} \leq f \leq 1.0\text{MHz}$	C_{ibo}		30	pF

SWITCHING CHARACTERISTICS

Parameters / Test Conditions	Symbol	Min.	Max.	Unit
Turn-On Time $V_{CC} = 30\text{Vdc}$; $I_C = 150\text{mA}$; $I_{B1} = 50\text{mA}$	t_{on}		45	ns
Turn-Off Time $V_{CC} = 30\text{Vdc}$; $I_C = 150\text{mA}$; $I_{B1} = -I_{B2} = 50\text{mA}$	t_{off}		300	ns

(4) Pulse Test: Pulse Width = 300 μs , Duty Cycle $\leq 2.0\%$.

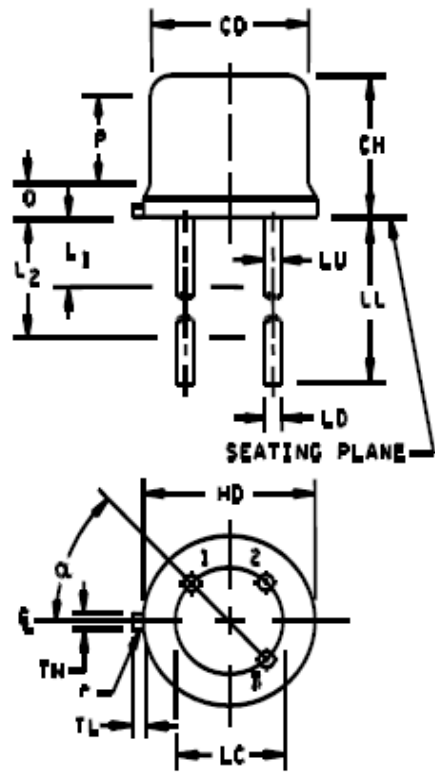
PACKAGE DIMENSIONS

NOTES:

1. Dimensions are in inches.
2. Millimeters are given for general information only.
3. Beyond r (radius) maximum, TW shall be held for a minimum length of .011 inch (0.28 mm).
4. Dimension TL measured from maximum HD.
5. Body contour optional within zone defined by HD, CD, and Q.
6. Leads at gauge plane $.054 + .001 - .000$ inch ($1.37 + 0.03 - 0.00$ mm) below seating plane shall be within .007 inch (0.18 mm) radius of true position (TP) at maximum material condition (MMC) relative to tab at MMC.
7. Dimension LU applies between L_1 and L_2 . Dimension LD applies between L_2 and LL minimum. Diameter is uncontrolled in L_1 and beyond LL minimum.
8. All three leads.
9. The collector shall be internally connected to the case.
10. Dimension r (radius) applies to both inside corners of tab.
11. In accordance with ASME Y14.5M, diameters are equivalent to ϕx symbology.
12. Lead 1 = emitter, lead 2 = base, lead 3 = collector.
13. For L suffix devices, dimension LL = 1.5 inches (38.10 mm) min. and 1.75 inches (44.45 mm) max.

Symbol	Dimensions				Note
	Inches		Millimeters		
	Min	Max	Min	Max	
CD	.178	.195	4.52	4.95	
CH	.170	.210	4.32	5.33	
HD	.209	.230	5.31	5.84	
LC	.100 TP		2.54 TP		6
LD	.016	.021	0.41	0.53	7,8
LL	.500	.750	12.70	19.05	7,8,13
LU	.016	.019	0.41	0.48	7,8
L_1		.050		1.27	7,8
L_2	.250		6.35		7,8
P	.100		2.54		
Q		.030		0.76	5
TL	.028	.048	0.71	1.22	3,4
TW	.036	.046	0.91	1.17	3
r		.010		0.25	10
α	45° TP		45° TP		6

FIGURE 1. Physical dimensions (similar to TO-18)

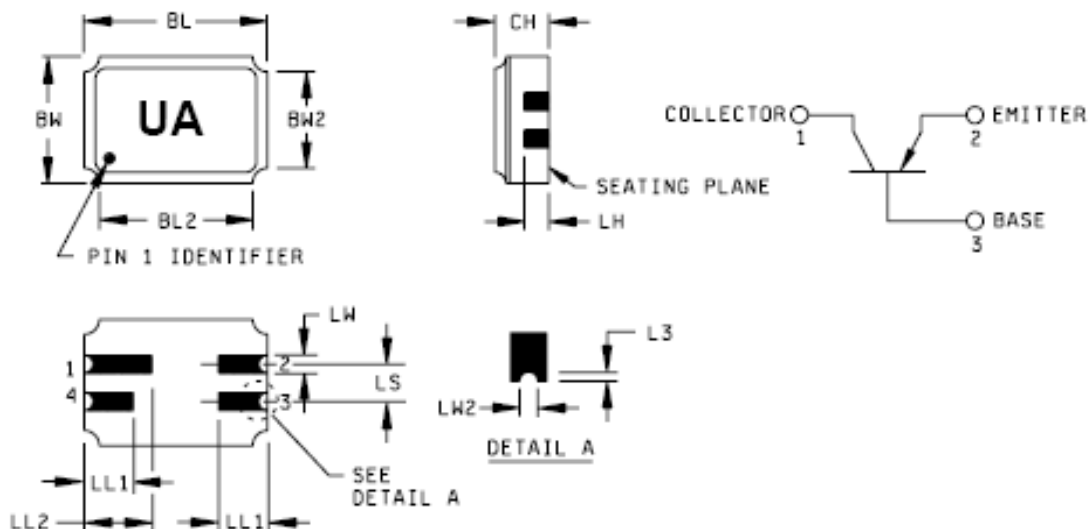
6 Lake Street, Lawrence, MA 01841
 1-800-446-1158 / (978) 620-2600 / Fax: (978) 689-0803
 Website: <http://www.microsemi.com>



NOTES:

1. Dimensions are in inches.
2. Millimeters are given for general information only.
3. Dimension “CH” controls the overall package thickness. When a window lid is used, dimension “CH” must increase by a minimum of .010 inch (0.254 mm) and a maximum of .040 inch (1.020 mm).
4. The corner shape (square, notch, radius) may vary at the manufacturer's option, from that shown on the drawing.
5. Dimensions “LW2” minimum and “L3” minimum and the appropriate castellation length define an unobstructed three-dimensional space traversing all of the ceramic layers in which a castellation was designed. (Castellations are required on the bottom two layers, optional on the top ceramic layer.) Dimension “LW2” maximum and “L3” maximum define the maximum width and depth of the castellation at any point on its surface. Measurement of these dimensions may be made prior to solder dipping.
6. The co-planarity deviation of all terminal contact points, as defined by the device seating plane, shall not exceed .006 inch (0.15mm) for solder dipped leadless chip carriers.
7. In accordance with ASME Y14.5M, diameters are equivalent to ϕx symbology.

Symbol	Dimensions				Note
	Inches		Millimeters		
	Min	Max	Min	Max	
BL	.215	.225	5.46	5.71	
BL2		.225		5.71	
BW	.145	.155	3.68	3.93	
BW2		.155		3.93	
CH	.061	.075	1.55	1.90	3
L3	.003	.007	0.08	0.18	5
LH	.029	.042	0.74	1.07	
LL1	.032	.048	0.81	1.22	
LL2	.072	.088	1.83	2.23	
LS	.045	.055	1.14	1.39	
LW	.022	.028	0.56	0.71	
LW2	.006	.022	0.15	0.56	5

Pin no.	1	2	3	4
Transistor	Collector	Emitter	Base	N/C

FIGURE 2. Physical dimensions, surface mount (UA version)

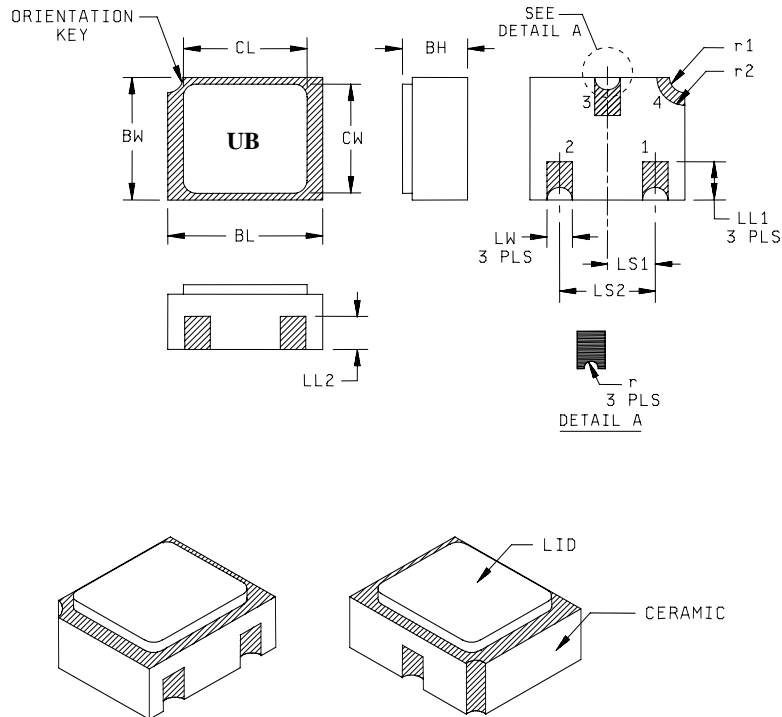

Symbol	Dimensions				Note
	Inches		Millimeters		
	Min	Max	Min	Max	
BH	.046	.056	1.17	1.42	
BL	.115	.128	2.92	3.25	
BW	.085	.108	2.16	2.74	
CL		.128		3.25	
CW		.108		2.74	
LL1	.022	.038	0.56	0.96	
LL2	.017	.035	0.43	0.89	

Symbol	Dimensions				Note
	Inches		Millimeters		
	Min	Max	Min	Max	
LS ₁	.036	.040	0.91	1.02	
LS ₂	.071	.079	1.81	2.01	
LW	.016	.024	0.41	0.61	
r		.008		.203	
r ₁		.012		.305	
r ₂		.022		.559	

NOTES:

1. Dimensions are in inches.
2. Millimeters are given for general information only.
3. Pad 1 = Base, Pad 2 = Emitter, Pad 3 = Collector, Pad 4 = Shielding connected to the lid.
4. In accordance with ASME Y14.5M, diameters are equivalent to ϕx symbology.

FIGURE 3. Physical dimensions, surface mount (UB version)

6 Lake Street, Lawrence, MA 01841
 1-800-446-1158 / (978) 620-2600 / Fax: (978) 689-0803
 Website: <http://www.microsemi.com>

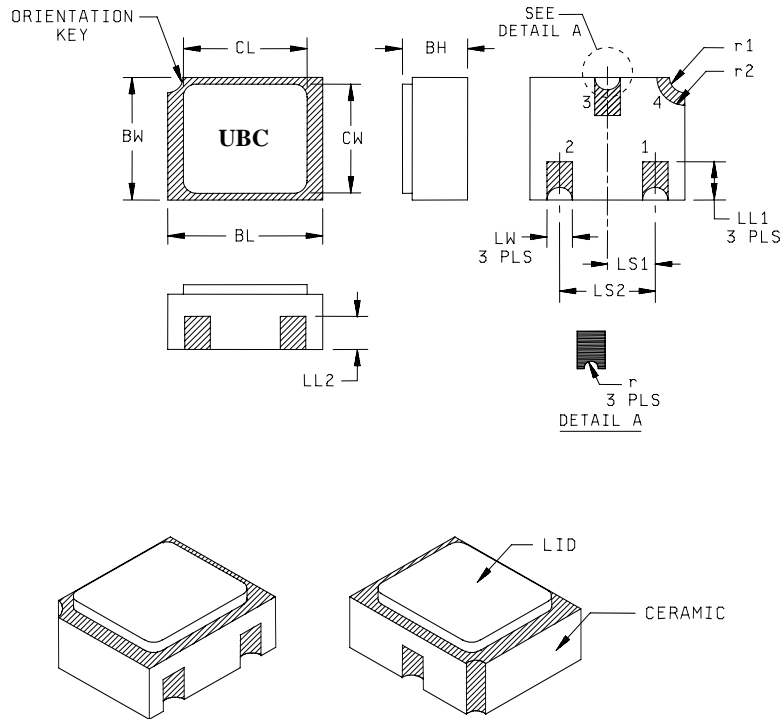

Symbol	Dimensions				Note
	Inches		Millimeters		
	Min	Max	Min	Max	
BH	.046	.071	1.17	1.80	
BL	.115	.128	2.92	3.25	
BW	.085	.108	2.16	2.74	
CL		.128		3.25	
CW		.108		2.74	
LL1	.022	.038	0.56	0.96	
LL2	.017	.035	0.43	0.89	

Symbol	Dimensions				Note
	Inches		Millimeters		
	Min	Max	Min	Max	
LS ₁	.036	.040	0.91	1.02	
LS ₂	.071	.079	1.81	2.01	
LW	.016	.024	0.41	0.61	
r		.008		.203	
r ₁		.012		.305	
r ₂		.022		.559	

NOTES:

1. Dimensions are in inches.
2. Millimeters are given for general information only.
3. Hatched areas on package denote metalized areas.
4. Pad 1 = Base, Pad 2 = Emitter, Pad 3 = Collector, Pad 4 = Connected to the lid braze ring.
5. In accordance with ASME Y14.5M, diameters are equivalent to ϕx symbology.

FIGURE 4. Physical dimensions, surface mount (UBC version, ceramic lid)