

# DA Series Miniature Single Pole Rocker Switches

## Features/Benefits

- Nice actuator styling with multiple options
- Guards to prevent accidental actuation
- Momentary and maintained functions
- IP65 splash proof rubber boot option
- RoHS compliant

## Typical Applications

- Small appliances
- Computers and peripherals
- Medical instrumentation



**UL** US **UL 61058-1**

## Specifications

### CONTACT RATING:

- 16 AMPS @ 125 VAC, 1/3 HP;
- 10 AMPS @ 250 VAC, 1/2 HP.
- 10 AMPS @ 125 VAC, 6 AMPS @ 250 VAC.

ELECTRICAL LIFE: 10,000 make and break cycles at full load.

INSULATION RESISTANCE:  $10^8 \Omega$  min.

DIELECTRIC STRENGTH: 1,500 VRMS @ sea level.

OPERATING TEMPERATURE: -20°C to +85°C

## Materials

HOUSING AND ACTUATOR: 6/6 nylon (UL94V-2), black, matte finish.

ILLUMINATED ACTUATOR: Polycarbonate, matte finish.

CENTER CONTACTS: Silver plated, copper alloy.

END CONTACTS: Silver plated.

ALL TERMINALS: Silver plated, copper alloy.

**NOTE:** Specifications and materials listed above are for switches with standard options. For information on specific and custom switches, consult Customer Service Center.

## Build-A-Switch

To order, simply select desired option from each category and place in the appropriate box. Available options are shown and described on pages G-57 through G-59. For additional options not shown in catalog, consult Customer Service Center.

<p><b>Switch Function</b></p> <p><b>DA101</b> SPDT On-None-On  <b>DA102</b> SPST On-None-Off  <b>DA103</b> SPDT On-Off-On</p>	<p><b>Actuator</b></p> <p><b>J1</b> Rocker  <b>J2</b> Two-tone rocker  <b>*, **J3</b> Illuminated rocker  <b>**J4</b> Circle, illuminated rocker  <b>**J5</b> Oval, illuminated rocker</p> <p><b>Actuator Color</b></p> <p><b>1-5</b> See Chart on Page G-59  <b>*R</b> Red, illuminated  <b>*A</b> Amber, illuminated  <b>*G</b> Green, illuminated</p>	<p><b>Mounting Style/Color</b></p> <p><b>S2</b> Snap-in, black  <b>S1</b> Snap-in, white  <b>B2</b> Recessed snap-in bracket, black  <b>G2</b> Guard, black</p> <p><b>Termination</b></p> <p><b>15</b> .187" quick connect  <b>17</b> Solder lug  <b>02</b> Thru-hole  <b>A</b> Right angle</p>	<p><b>Actuator Marking</b></p> <p><b>(NONE)</b> No marking  <b>D</b> ON-OFF  <b>H</b> "O I" - international ON-OFF  <b>N</b> Large dot  <b>P</b> "O -" international ON-OFF</p>	<p><b>Contact Rating</b></p> <p><b>QF</b> Silver</p>	<p><b>Lamp Rating</b></p> <p><b>(NONE)</b> No lamp  <b>6</b> LED  <b>7</b> 125 VAC neon  <b>8</b> 250 VAC neon</p>
---	--	---	---	--	--

\* Actuator "J3" illuminated switches are not available with actuator markings

\*\* Actuator "J3", "J4" and "J5" are not available with Termination option "17" solder lug

Rocker



Dimensions are shown: Inches (mm)  
 Specifications and dimensions subject to change

# DA Series Miniature Single Pole Rocker Switches

## SWITCH FUNCTION

NO. POLES	MODEL NO.	SWITCH FUNCTION			CONNECTED TERMINALS			SCHEMATIC
SP	DA101	ON	NONE	ON	2-3	N/A	2-1	
	DA102	ON	NONE	OFF				 OR For 7 & 8 Illuminated Versions Only
	DA103	ON	OFF	ON				 For 6 Illuminated Versions Only

Shown in Pos. 1

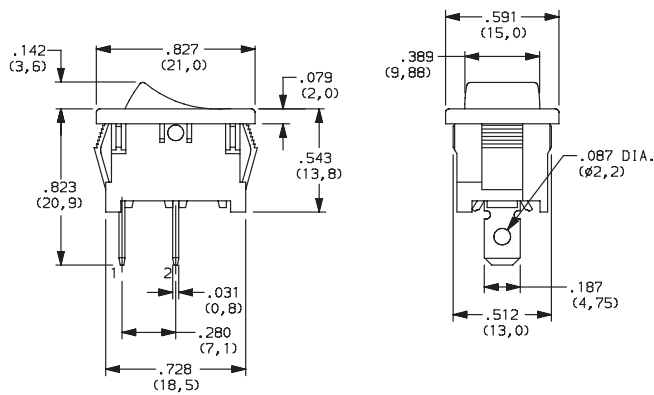

## ACTUATOR

- J1** ROCKER
- \*J3** ILLUMINATED ROCKER

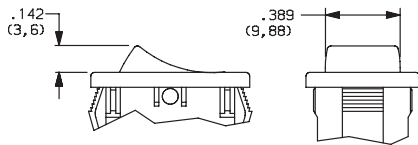

**NOTE:** J3 actuator available with DA102 switch functions, 7&8 lamp ratings and not available with O2 and A termination options.

\* J3 actuator not available with markings or Termination option "17" solder lug

- J2** TWO-TONE ROCKER

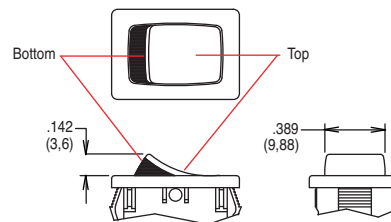

**NOTE:**

1. Available with DA102 switch function only.
2. Available with None or P actuator marking options only.

**C&K**



# DA Series Miniature Single Pole Rocker Switches

## ACTUATOR

### J4 CIRCLE, ILLUMINATED ROCKER

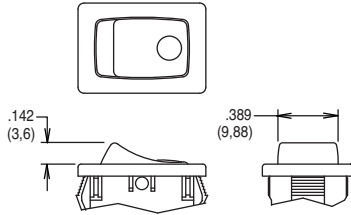

**NOTE:** Available with DA102 switch function and 7 & 8 lamp ratings combinations only. Not available with O2 and A termination options. \* J4 actuator not available with Termination option "17" solder lug

### J5 OVAL, ILLUMINATED ROCKER

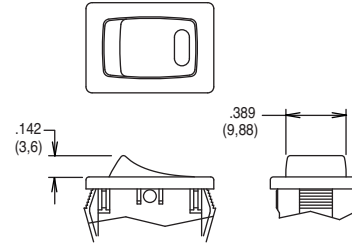

**NOTE:** Available with DA102 switch function and 6 lamp rating combinations only. Not available with O2 and A termination options. \* J5 actuator not available with Termination option "17" solder lug

## ACTUATOR COLOR

ACTUATOR COLOR	OPTION CODE	ACTUATOR COLOR
	<b>J1 only</b>	<b>2</b>
<b>1</b>		WHITE
<b>3</b>		RED
<b>J3, J4, J5 only</b>	<b>R</b>	RED, ILLUMINATED
	<b>A</b>	AMBER, ILLUMINATED
	<b>G</b>	GREEN, ILLUMINATED

ACTUATOR COLOR	OPTION CODE	ACTUATOR COLOR	
	OPTION CODE	TOP	BOTTOM
<b>J2 only</b>	<b>1</b>	WHITE	RED
	<b>2</b>	WHITE	BLACK
	<b>3</b>	RED	WHITE
	<b>4</b>	BLACK	WHITE
	<b>5</b>	BLACK	RED

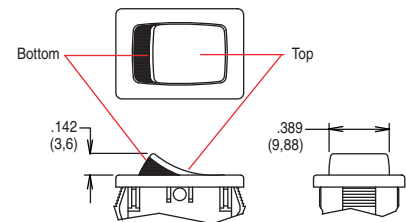

## MOUNTING STYLE/COLOR

### S2 SNAP-IN, BLACK

### S1 SNAP-IN, WHITE

### G2 GUARD, BLACK

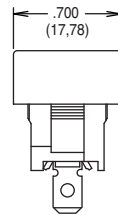
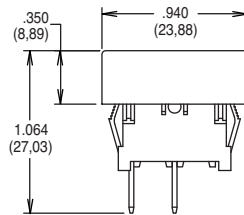
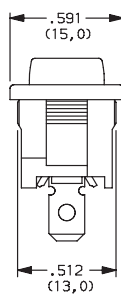
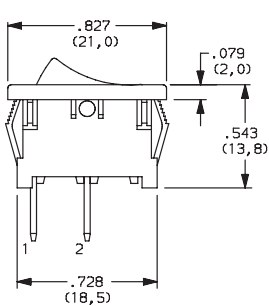

### S2, S1 & G2 PANEL MOUNTING

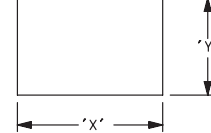

PANEL THICKNESS	"X"	"Y"
0.030-0.049 (0,75-1,25)	0.756-.004 (19,2-0,1)	0.512+.004 (13,0+0,1)
0.049-0.079 (1,25-2,0)	0.764-.004 (19,4-0,1)	0.512+.004 (13,0+0,1)
0.079-0.118 (2,0-3,0)	0.779-.004 (19,8-0,1)	0.512+.004 (13,0+0,1)

**NOTE:** Available with DA10X switch functions only.

Actuator shown in Pos. 1

### B2 RECESSED SNAP-IN BRACKET, BLACK

### B2 PANEL MOUNTING

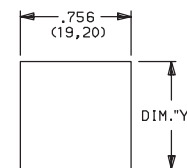
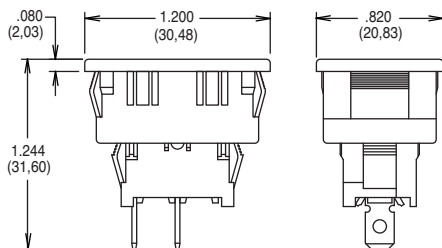

PANEL THICKNESS	"Y"
0.030-0.049 (0,75-0,25)	1.068 (27,13)
0.049-0.079 (1,25-2,0)	1.076 (27,33)
0.079-0.118 (2,0-3,0)	1.092 (27,74)

**NOTE:** Available with DA10X switch functions only.

Rocker



G

**C&K**



Third Angle  
Projection

Dimensions are shown: Inches (mm)  
Specifications and dimensions subject to change

# DA Series Miniature Single Pole Rocker Switches

## TERMINATION

### 15 .187" QUICK CONNECT

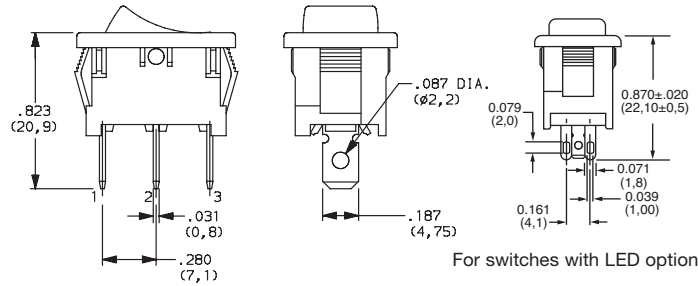

### 17 SOLDER LUG

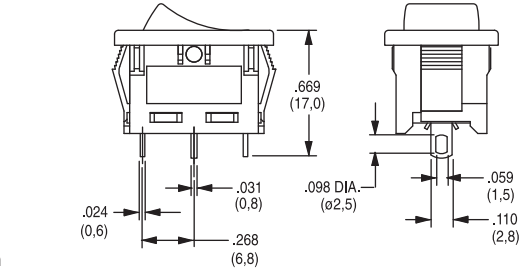

### 02\* THRU-HOLE

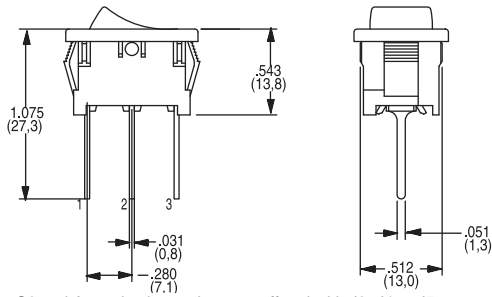

### A\* RIGHT ANGLE

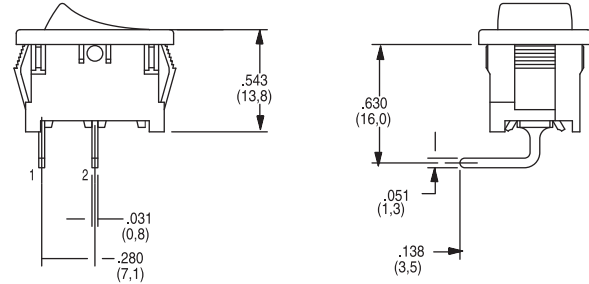

\* NOTE - O2 and A termination options not offered with J3, J4 or J5 actuator options.

## ACTUATOR MARKING

### NONE NO MARKING

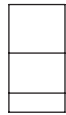

### D ON-OFF



### H O I



### N LARGE DOT



### P O -

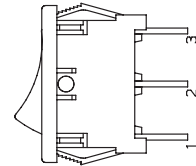

All models shown in Pos. 1  
Markings not available with J3 actuator

NOTE: Orientation of actuator marking and terminals.

## CONTACT MATERIAL

OPTION CODE	CONTACT AND TERMINAL MATERIAL	RATINGS	
QF	SILVER	POWER	16 AMPS @ 125 VAC; 1/3 HP; 10 AMPS @ 250 VAC; 1/2 10 AMPS @ 125 VAC, 6 AMPS @ 250 VAC

\* Note: See Technical Data section of this catalog for RoHS compliant and compatible definitions and specifications.

## LAMP RATING

(NONE) NO LAMP

6 LED RATING @ 10 mA  $V_f=1.85V$

7 125 VAC 33kΩ NEON

8 250 VAC 150kΩ NEON

## ACCESSORIES

216C0000 IP65 SPLASH PROOF RUBBER BOOT

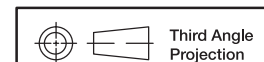
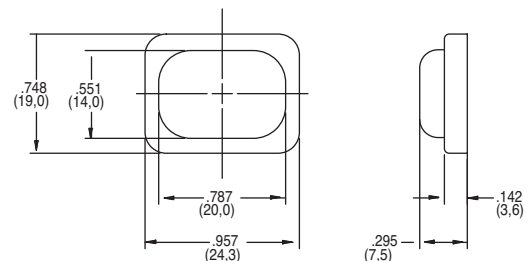

Third Angle Projection  
Dimensions are shown: Inches (mm)  
Specifications and dimensions subject to change

**C&K**

