

NTJD4105C

Small Signal MOSFET 20 V / -8.0 V, Complementary, +0.63 A / -0.775 A, SC-88

Features

- Complementary N and P Channel Device
- Leading -8.0 V Trench for Low $R_{DS(on)}$ Performance
- ESD Protected Gate – ESD Rating: Class 1
- SC-88 Package for Small Footprint (2 x 2 mm)
- Pb-Free Packages are Available

Applications

- DC-DC Conversion
- Load/Power Switching
- Single or Dual Cell Li-Ion Battery Supplied Devices
- Cell Phones, MP3s, Digital Cameras, PDAs

MAXIMUM RATINGS ($T_J = 25^\circ\text{C}$ unless otherwise noted)

Parameter	Symbol	Value	Unit
Drain-to-Source Voltage	N-Ch	V_{DSS}	20 V
	P-Ch		-8.0
Gate-to-Source Voltage	N-Ch	V_{GS}	± 12 V
	P-Ch		± 8.0
Continuous Drain Current – Steady State (Based on $R_{\theta JA}$)	N-Ch	$T_A = 25^\circ\text{C}$	0.63 A
		$T_A = 85^\circ\text{C}$	0.46
	P-Ch	$T_A = 25^\circ\text{C}$	-0.775
		$T_A = 85^\circ\text{C}$	-0.558
Continuous Drain Current – Steady State (Based on $R_{\theta JL}$)	N-Ch	$T_A = 25^\circ\text{C}$	0.91
		$T_A = 85^\circ\text{C}$	0.65
	P-Ch	$T_A = 25^\circ\text{C}$	-1.1
		$T_A = 85^\circ\text{C}$	-0.8
Pulsed Drain Current	$tp \leq 10 \mu\text{s}$	I_{DM}	± 1.2 A
Power Dissipation – Steady State (Based on $R_{\theta JA}$)	$T_A = 25^\circ\text{C}$	P_D	0.27 W
	$T_A = 85^\circ\text{C}$		0.14
Power Dissipation – Steady State (Based on $R_{\theta JL}$)	$T_A = 25^\circ\text{C}$		0.55
	$T_A = 85^\circ\text{C}$		0.29
Operating Junction and Storage Temperature	T_J, T_{STG}	-55 to 150	$^\circ\text{C}$
Source Current (Body Diode)	N-Ch	I_S	0.63 A
	P-Ch		-0.775
Lead Temperature for Soldering Purposes (1/8" from case for 10 s)	T_L	260	$^\circ\text{C}$

THERMAL RESISTANCE RATINGS (Note 1)

Parameter	Typ	Max	Unit
Junction-to-Ambient – Steady State	$R_{\theta JA}$	400	$^\circ\text{C/W}$
		460	
Junction-to-Lead (Drain) – Steady State	$R_{\theta JL}$	194	
		226	

Stresses exceeding Maximum Ratings may damage the device. Maximum Ratings are stress ratings only. Functional operation above the Recommended Operating Conditions is not implied. Extended exposure to stresses above the Recommended Operating Conditions may affect device reliability.

1. Surface mounted on FR4 board using 1 oz Cu area = 0.9523 in sq.



ON Semiconductor®

<http://onsemi.com>

$V_{(BR)DSS}$	$R_{DS(on)}$ TYP	I_D Max
N-Ch 20 V	0.29 Ω @ 4.5 V	0.63 A
	0.36 Ω @ 2.5 V	
P-Ch -8.0 V	0.22 Ω @ -4.5 V	-0.775 A
	0.32 Ω @ -2.5 V	
	0.51 Ω @ -1.8 V	

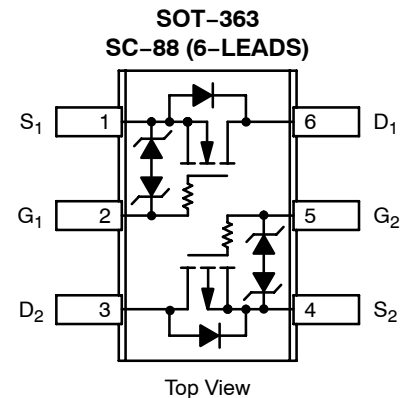

MARKING DIAGRAM & PIN ASSIGNMENT

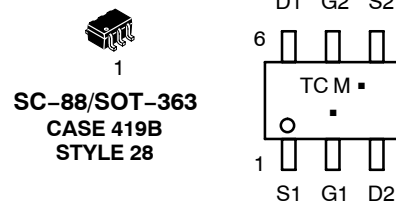

TC = Device Code
M = Date Code
▪ = Pb-Free Package

(Note: Microdot may be in either location)

ORDERING INFORMATION

See detailed ordering and shipping information in the package dimensions section on page 7 of this data sheet.

NTJD4105C

ELECTRICAL CHARACTERISTICS (T_J = 25°C unless otherwise noted)

Parameter	Symbol	N/P	Test Condition	Min	Typ	Max	Units
OFF CHARACTERISTICS							
Drain-to-Source Breakdown Voltage	V _{(BR)DSS}	N	V _{GS} = 0 V	I _D = 250 μA	20	27	V
		P		I _D = -250 μA	-8.0	-10.5	
Drain-to-Source Breakdown Voltage Temperature Coefficient	V _{(BR)DSS} / T _J	N			22		mV/°C
		P			-6.0		
Zero Gate Voltage Drain Current	I _{DSS}	N	V _{GS} = 0 V, V _{DS} = 16 V	T _J = 25 °C		1.0	μA
		P	V _{GS} = 0 V, V _{DS} = -6.4 V			1.0	
Gate-to-Source Leakage Current	I _{GSS}	N	V _{DS} = 0 V	V _{GS} = ±12 V		10	μA
		P		V _{GS} = ±8.0		10	

ON CHARACTERISTICS (Note 2)

Gate Threshold Voltage	V _{GS(TH)}	N	V _{GS} = V _{DS}	I _D = 250 μA	0.6	0.92	1.5	V
		P		I _D = -250 μA	-0.45	-0.83	-1.0	
Gate Threshold Temperature Coefficient	V _{GS(TH)} / T _J	N				-2.1		-mV/°C
		P					2.2	
Drain-to-Source On Resistance	R _{DS(on)}	N	V _{GS} = 4.5 V, I _D = 0.63 A		0.29	0.375	Ω	
		P	V _{GS} = -4.5 V, I _D = -0.57 A		0.22	0.30		
		N	V _{GS} = 2.5 V, I _D = 0.40 A		0.36	0.445		
		P	V _{GS} = -2.5 V, I _D = -0.48 A		0.32	0.46		
		P	V _{GS} = -1.8 V, I _D = -0.20 A		0.51	0.90		
Forward Transconductance	g _{FS}	N	V _{DS} = 4.0 V, I _D = 0.63 A		2.0		S	
		P	V _{DS} = -4.0 V, I _D = -0.57 A		2.0			

CHARGES AND CAPACITANCES

Input Capacitance	C _{ISS}	N	f = 1 MHz, V _{GS} = 0 V	V _{DS} = 20 V		33	46	pF	
		P		V _{DS} = -8.0V		160	225		
Output Capacitance	C _{OSS}	N		V _{DS} = 20 V		13	22		
		P		V _{DS} = -8.0 V		38	55		
Reverse Transfer Capacitance	C _{RSS}	N		V _{DS} = 20 V		2.8	5.0		
		P		V _{DS} = -8.0 V		28	40		
Total Gate Charge	Q _{G(TOT)}	N		V _{GS} = 4.5 V, V _{DS} = 10 V, I _D = 0.7 A		1.3	3.0		nC
		P		V _{GS} = -4.5 V, V _{DS} = -5.0 V, I _D = -0.6 A		2.2	4.0		
Threshold Gate Charge	Q _{G(TH)}	N		V _{GS} = 4.5 V, V _{DS} = 10 V, I _D = 0.7 A		0.1			
		P		V _{GS} = -4.5 V, V _{DS} = -5.0 V, I _D = -0.6 A		0.1			
Gate-to-Source Charge	Q _{GS}	N	V _{GS} = 4.5 V, V _{DS} = 10 V, I _D = 0.7 A		0.2				
		P	V _{GS} = -4.5 V, V _{DS} = -5.0 V, I _D = -0.6 A		0.5				
Gate-to-Drain Charge	Q _{GD}	N	V _{GS} = 4.5 V, V _{DS} = 10 V, I _D = 0.7 A		0.4				
		P	V _{GS} = -4.5 V, V _{DS} = -5.0 V, I _D = -0.6 A		0.5				

SWITCHING CHARACTERISTICS (Note 3)

Turn-On Delay Time	t _{d(ON)}	N	V _{GS} = 4.5 V, V _{DD} = 10 V, I _D = 0.5 A, R _G = 20 Ω		0.083		μs	
Rise Time	t _r				0.227			
Turn-Off Delay Time	t _{d(OFF)}				0.786			
Fall Time	t _f				0.506			
Turn-On Delay Time	t _{d(ON)}	P		V _{GS} = -4.5 V, V _{DD} = -4.0 V, I _D = -0.5 A, R _G = 8.0 Ω		0.013		
Rise Time	t _r					0.023		
Turn-Off Delay Time	t _{d(OFF)}					0.050		
Fall Time	t _f					0.036		

DRAIN-SOURCE DIODE CHARACTERISTICS

Forward Diode Voltage	V _{SD}	N	V _{GS} = 0 V, T _J = 25°C	I _S = 0.23 A		0.76	1.1	V
		P		I _S = -0.23 A		0.76	1.1	
		N	V _{GS} = 0 V, T _J = 125°C	I _S = 0.23 A		0.63		
		P		I _S = -0.23 A		0.63		
Reverse Recovery Time	t _{RR}	N	V _{GS} = 0 V, dI _S /dt = 90 A/μs	I _S = 0.23 A		0.410		μs
		P		I _S = -0.23 A		0.078		

2. Pulse Test: pulse width ≤ 300 μs, duty cycle ≤ 2%.

3. Switching characteristics are independent of operating junction temperatures.

NTJD4105C

TYPICAL N-CANNEL PERFORMANCE CURVES ($T_J = 25^\circ\text{C}$ unless otherwise noted)

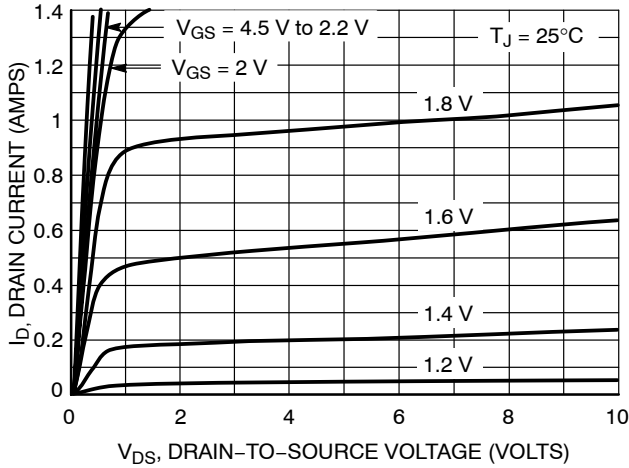

Figure 1. On-Region Characteristics

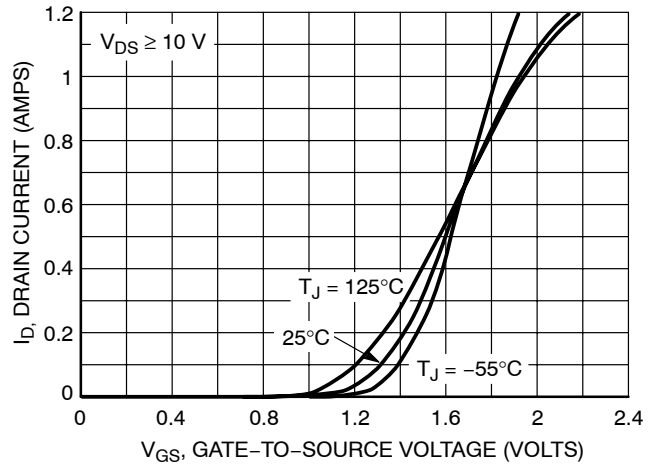

Figure 2. Transfer Characteristics

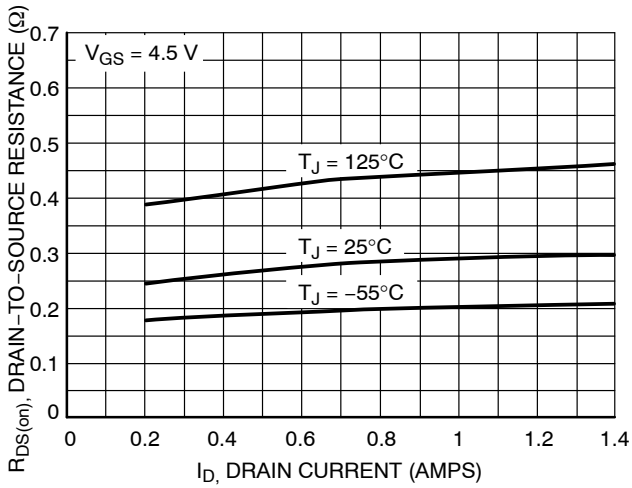

Figure 3. On-Resistance vs. Drain Current and Temperature

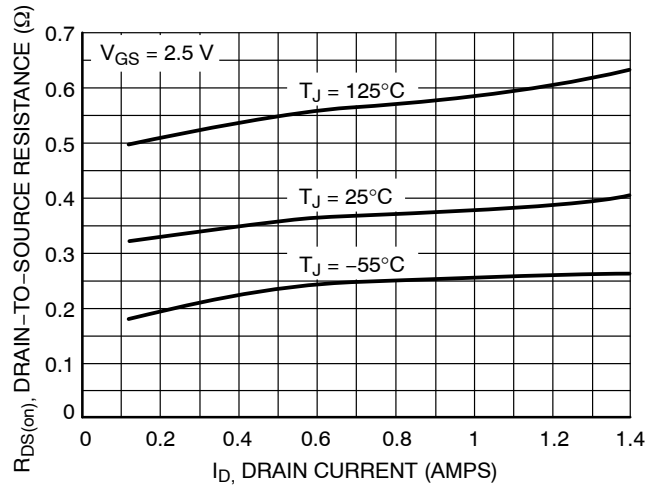

Figure 4. On-Resistance vs. Drain Current and Temperature

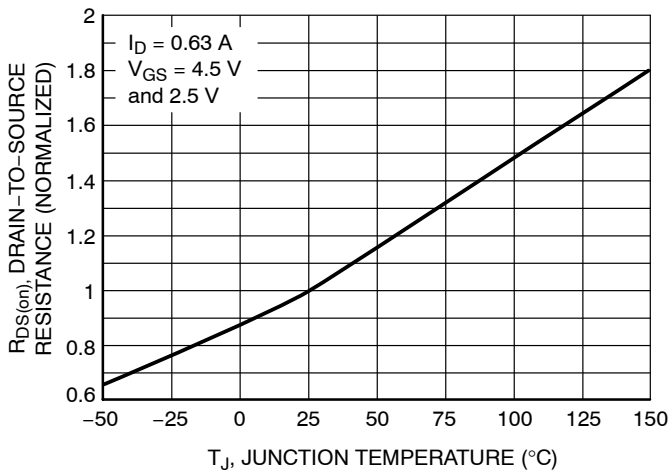

Figure 5. On-Resistance Variation with Temperature

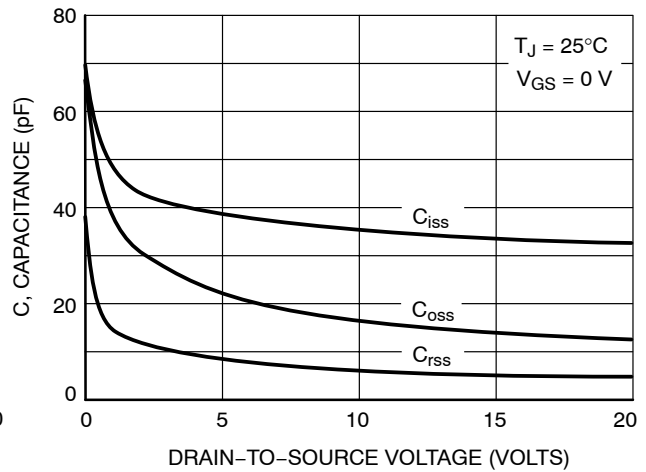

Figure 6. Capacitance Variation

NTJD4105C

TYPICAL N-CHANNEL PERFORMANCE CURVES ($T_J = 25^\circ\text{C}$ unless otherwise noted)

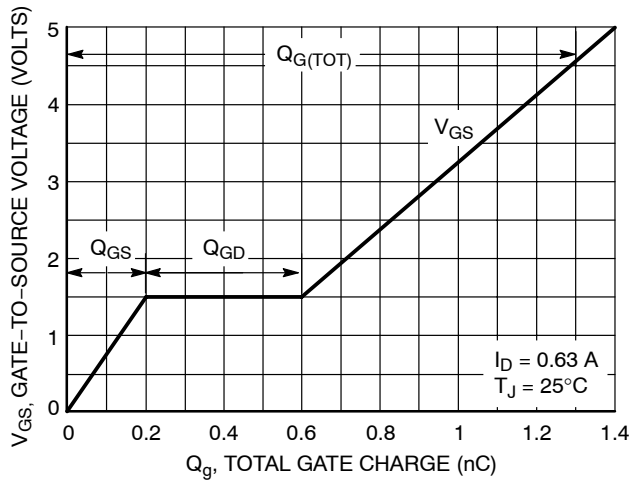

Figure 7. Gate-to-Source and Drain-to-Source Voltage vs. Total Charge

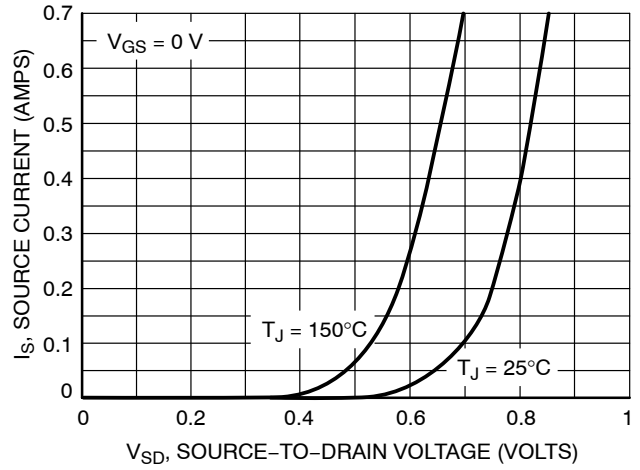

Figure 8. Diode Forward Voltage vs. Current

TYPICAL P-CHANNEL PERFORMANCE CURVES ($T_J = 25^\circ\text{C}$ unless otherwise noted)

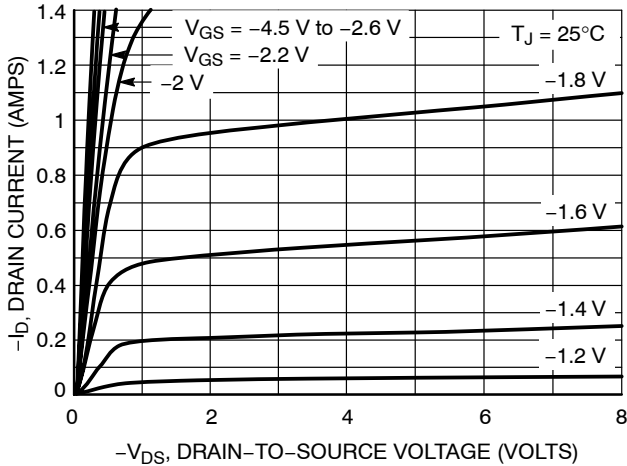

Figure 9. On-Region Characteristics

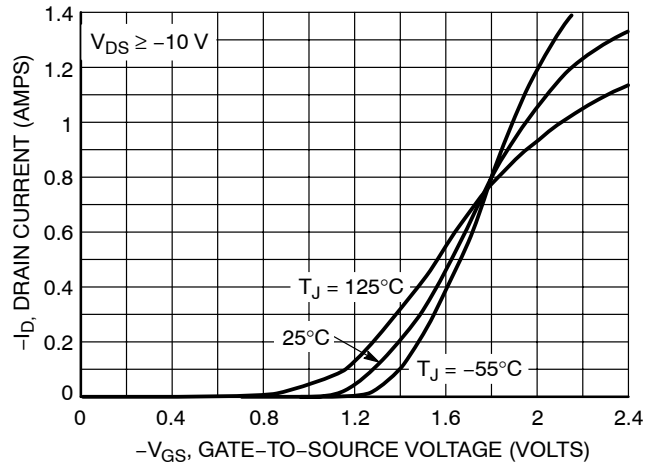

Figure 10. Transfer Characteristics

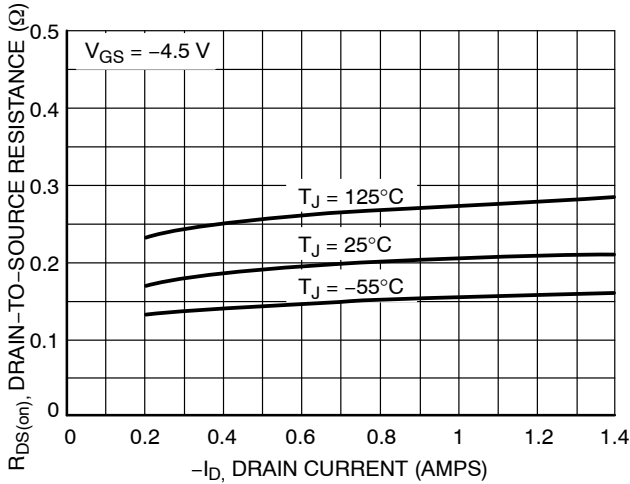

Figure 11. On-Resistance vs. Drain Current and Temperature

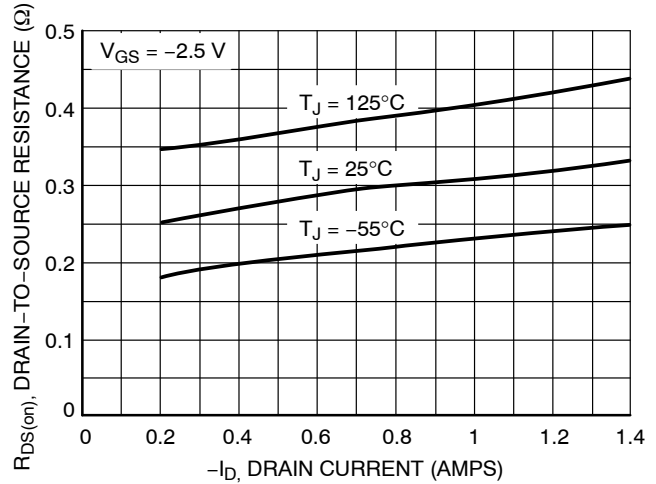

Figure 12. On-Resistance vs. Drain Current and Temperature

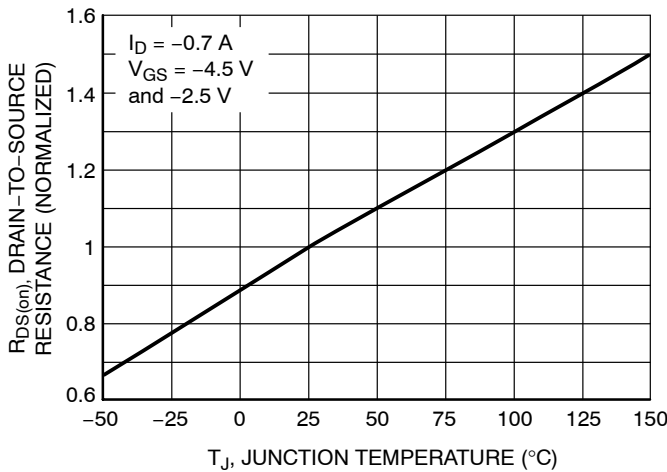

Figure 13. On-Resistance Variation with Temperature

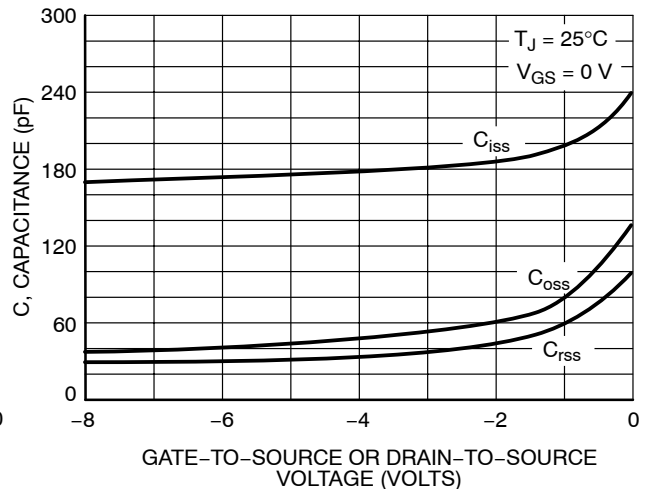

Figure 14. Capacitance Variation

NTJD4105C

TYPICAL P-CHANNEL PERFORMANCE CURVES ($T_J = 25^\circ\text{C}$ unless otherwise noted)

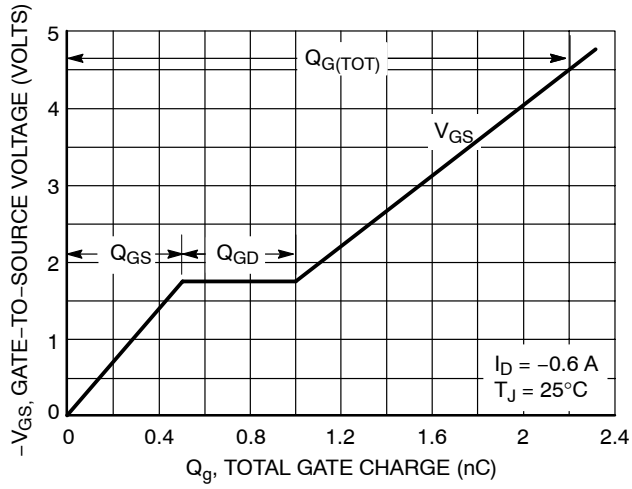

Figure 15. Gate-to-Source and Drain-to-Source Voltage vs. Total Charge

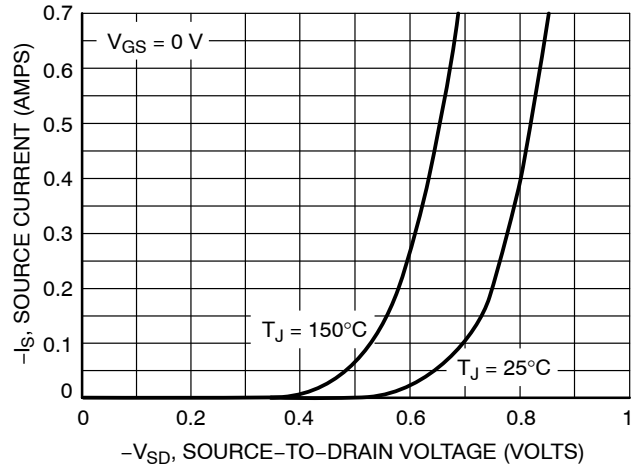

Figure 16. Diode Forward Voltage vs. Current

NTJD4105C

ORDERING INFORMATION

Device	Package	Shipping†
NTJD4105CT1	SOT-363	3000 / Tape & Reel
NTJD4105CT1G	SOT-363 (Pb-Free)	3000 / Tape & Reel
NTJD4105CT2	SOT-363	3000 / Tape & Reel
NTJD4105CT2G	SOT-363 (Pb-Free)	3000 / Tape & Reel
NTJD4105CT4	SOT-363	10,000 / Tape & Reel
NTJD4105CT4G	SOT-363 (Pb-Free)	10,000 / Tape & Reel

†For information on tape and reel specifications, including part orientation and tape sizes, please refer to our Tape and Reel Packaging Specifications Brochure, BRD8011/D.

NTJD4105C

PACKAGE DIMENSIONS

SC-88/SC70-6/SOT-363
CASE 419B-02
ISSUE W

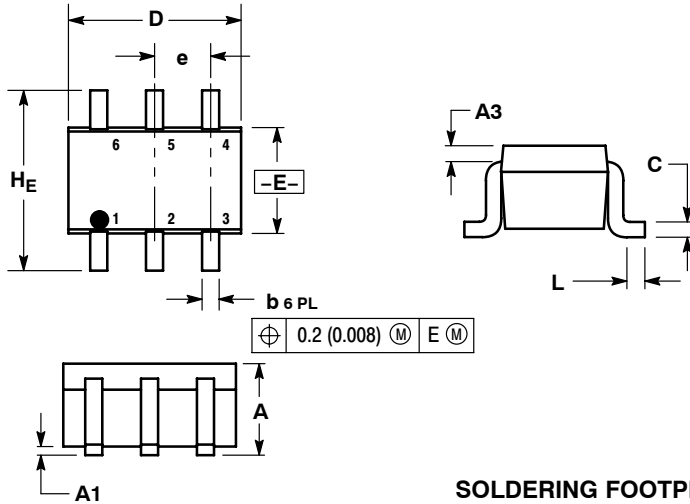

NOTES:

1. DIMENSIONING AND TOLERANCING PER ANSI Y14.5M, 1982.
2. CONTROLLING DIMENSION: INCH.
3. 419B-01 OBSOLETE, NEW STANDARD 419B-02.

DIM	MILLIMETERS			INCHES		
	MIN	NOM	MAX	MIN	NOM	MAX
A	0.80	0.95	1.10	0.031	0.037	0.043
A1	0.00	0.05	0.10	0.000	0.002	0.004
A3	0.20 REF			0.008 REF		
b	0.10	0.21	0.30	0.004	0.008	0.012
C	0.10	0.14	0.25	0.004	0.005	0.010
D	1.80	2.00	2.20	0.070	0.078	0.086
E	1.15	1.25	1.35	0.045	0.049	0.053
e	0.65 BSC			0.026 BSC		
L	0.10	0.20	0.30	0.004	0.008	0.012
HE	2.00	2.10	2.20	0.078	0.082	0.086

STYLE 26:

- PIN 1. SOURCE 1
- GATE 1
- DRAIN 2
- SOURCE 2
- GATE 2
- DRAIN 1

SOLDERING FOOTPRINT*

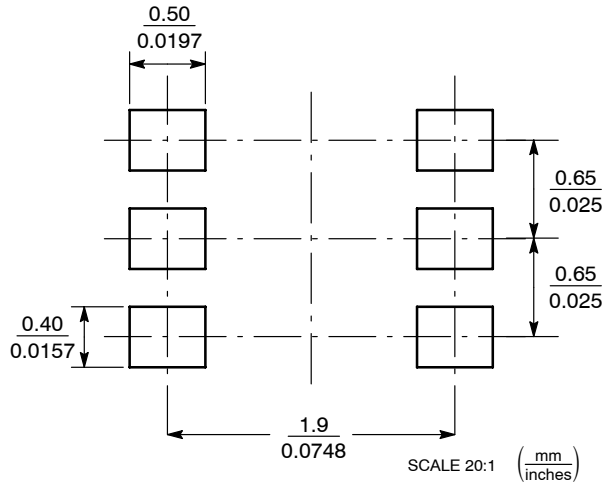

*For additional information on our Pb-Free strategy and soldering details, please download the ON Semiconductor Soldering and Mounting Techniques Reference Manual, SOLDERRM/D.

ON Semiconductor and are registered trademarks of Semiconductor Components Industries, LLC (SCILLC). SCILLC reserves the right to make changes without further notice to any products herein. SCILLC makes no warranty, representation or guarantee regarding the suitability of its products for any particular purpose, nor does SCILLC assume any liability arising out of the application or use of any product or circuit, and specifically disclaims any and all liability, including without limitation special, consequential or incidental damages. "Typical" parameters which may be provided in SCILLC data sheets and/or specifications can and do vary in different applications and actual performance may vary over time. All operating parameters, including "Typicals" must be validated for each customer application by customer's technical experts. SCILLC does not convey any license under its patent rights nor the rights of others. SCILLC products are not designed, intended, or authorized for use as components in systems intended for surgical implant into the body, or other applications intended to support or sustain life, or for any other application in which the failure of the SCILLC product could create a situation where personal injury or death may occur. Should Buyer purchase or use SCILLC products for any such unintended or unauthorized application, Buyer shall indemnify and hold SCILLC and its officers, employees, subsidiaries, affiliates, and distributors harmless against all claims, costs, damages, and expenses, and reasonable attorney fees arising out of, directly or indirectly, any claim of personal injury or death associated with such unintended or unauthorized use, even if such claim alleges that SCILLC was negligent regarding the design or manufacture of the part. SCILLC is an Equal Opportunity/Affirmative Action Employer. This literature is subject to all applicable copyright laws and is not for resale in any manner.

PUBLICATION ORDERING INFORMATION

LITERATURE FULFILLMENT:
Literature Distribution Center for ON Semiconductor
P.O. Box 61312, Phoenix, Arizona 85082-1312 USA
Phone: 480-829-7710 or 800-344-3860 Toll Free USA/Canada
Fax: 480-829-7709 or 800-344-3867 Toll Free USA/Canada
Email: orderlit@onsemi.com

N. American Technical Support: 800-282-9855 Toll Free
USA/Canada

Japan: ON Semiconductor, Japan Customer Focus Center
2-9-1 Kamimeguro, Meguro-ku, Tokyo, Japan 153-0051
Phone: 81-3-5773-3850

ON Semiconductor Website: <http://onsemi.com>

Order Literature: <http://www.onsemi.com/litorder>

For additional information, please contact your local Sales Representative.