

SMD Power Inductor CR32

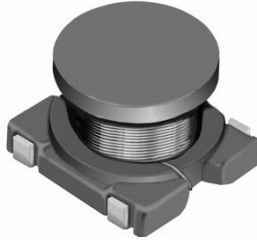

Description

- Ferrite drum core construction.
- Magnetically unshielded.
- L × W × H: 4.1 × 3.8 × 3.0 mm Max.
- Product weight: 85mg(Ref.)
- Moisture Sensitivity Level: 1
- RoHS compliance.

Environmental Data

- Operating temperature range: -40°C ~ +100°C (including coil's self temperature rise)
- Storage temperature range: -40°C ~ +100°C
- Solder reflow temperature: 260 °C peak.

Packaging

- Carrier tape and reel packaging
- 12" diameter reel
- 2000pcs per reel

Applications

- Ideally used in A/V equipment, LCD TV, DSC/DVC, Game Machine, DVC, HDD, Notebook PC, etc as DC-DC converter inductors.

Dimension - [mm]

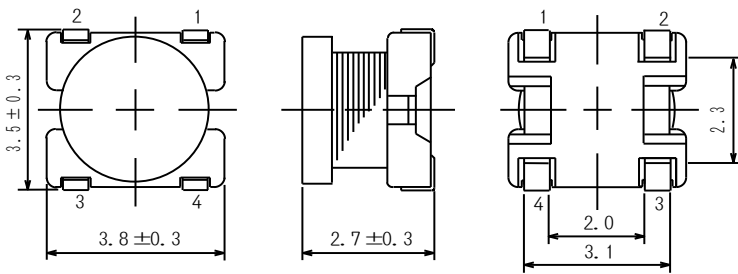

Land pattern and Schematics - [mm]

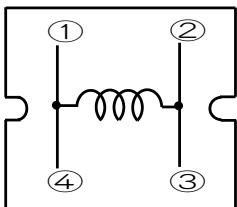
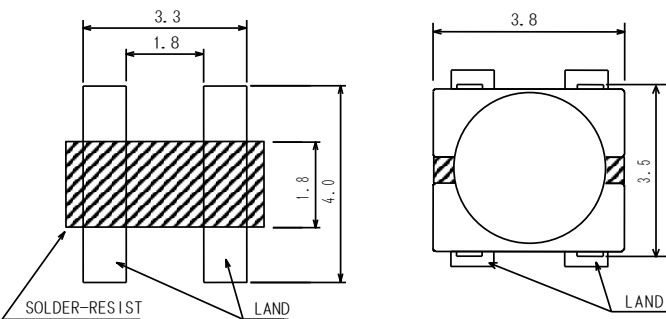



Electrical Characteristics

Part Name	Stamp	Inductance (μH) [within] $\times 1$	D.C.R. (m Ω) [Max.] at 20°C	Rated Current (mA) $\times 2$
CR32NP-1R0MC	<u>A</u>	1.0 \pm 20%	72	2100
CR32NP-1R2MC	<u>B</u>	1.2 \pm 20%	78	1700
CR32NP-1R5MC	<u>C</u>	1.5 \pm 20%	85	1500
CR32NP-1R8MC	<u>D</u>	1.8 \pm 20%	91	1320
CR32NP-2R2MC	<u>E</u>	2.2 \pm 20%	104	1280
CR32NP-2R7MC	<u>F</u>	2.7 \pm 20%	111	1240
CR32NP-3R3MC	<u>G</u>	3.3 \pm 20%	137	1180
CR32NP-3R9MC	<u>H</u>	3.9 \pm 20%	143	1150
CR32NP-4R7MC	<u>J</u>	4.7 \pm 20%	170	1040
CR32NP-5R6MC	<u>K</u>	5.6 \pm 20%	176	1000
CR32NP-6R8MC	<u>L</u>	6.8 \pm 20%	202	880
CR32NP-7R4MC	<u>M</u>	7.4 \pm 20%	215	840
CR32NP-8R2MC	<u>N</u>	8.2 \pm 20%	228	780
CR32NP-100KC	A	10 \pm 10%	230	760
CR32NP-120KC	B	12 \pm 10%	270	685
CR32NP-150KC	C	15 \pm 10%	310	635
CR32NP-180KC	D	18 \pm 10%	410	525
CR32NP-220KC	E	22 \pm 10%	470	500
CR32NP-270KC	F	27 \pm 10%	660	405
CR32NP-330KC	G	33 \pm 10%	760	380
CR32NP-390KC	H	39 \pm 10%	850	355
CR32NP-470KC	J	47 \pm 10%	970	330
CR32NP-560KC	K	56 \pm 10%	1250	290
CR32NP-680KC	L	68 \pm 10%	1450	275
CR32NP-820KC	M	82 \pm 10%	1850	235
CR32NP-101KC	N	100 \pm 10%	2200	220
CR32NP-121KC	P	120 \pm 10%	2900	185
CR32NP-151KC	Q	150 \pm 10%	3400	170
CR32NP-181KC	R	180 \pm 10%	3900	165
CR32NP-221KC	S	220 \pm 10%	4500	155
CR32NP-271KC	T	270 \pm 10%	6000	135
CR32NP-331KC	U	330 \pm 10%	7000	125
CR32NP-391KC	V	390 \pm 10%	7800	115

※1. Inductance measuring frequency: 1.0 μH ~ 8.2 μH ; at 7.96 MHz
10 μH ~ 390 μH ; at 100 kHz

※2. Rated current: The D.C. current at which the inductance decreases to 90% of its initial value or when $\Delta t=40^\circ\text{C}$, whichever is lower ($T_a=20^\circ\text{C}$).

SMD Power Inductor CR32

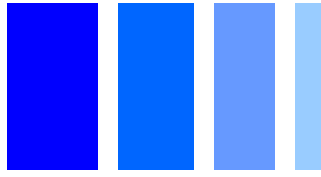

Saturation Current & Temperature Rise Graph

— L (20°C) — L (100°C) — ΔT

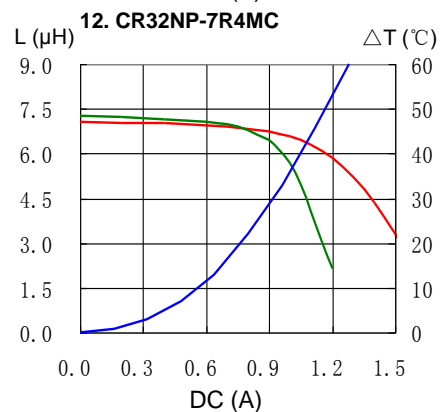
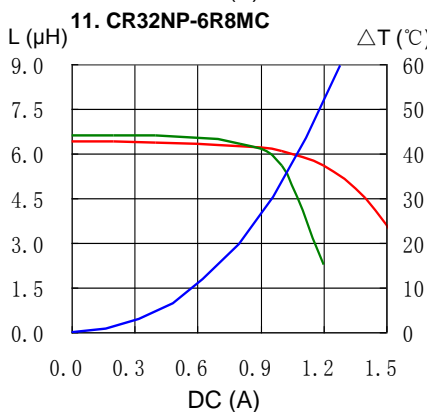
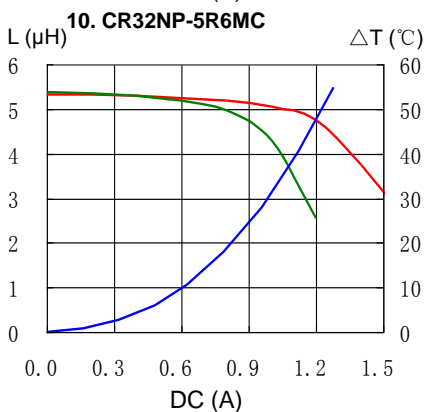
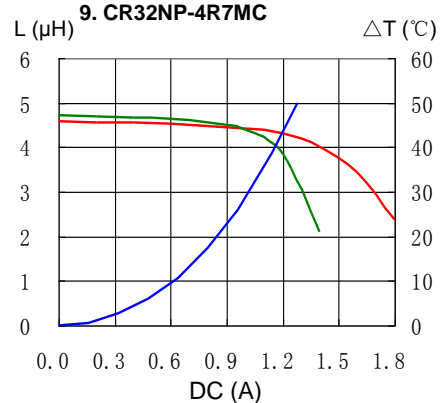
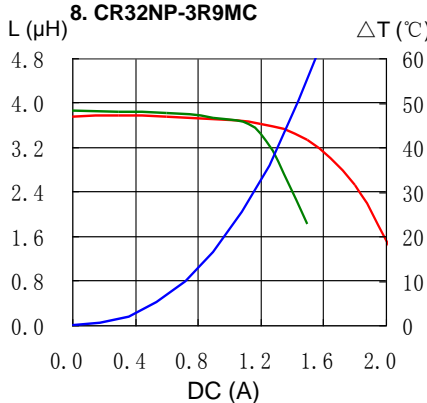
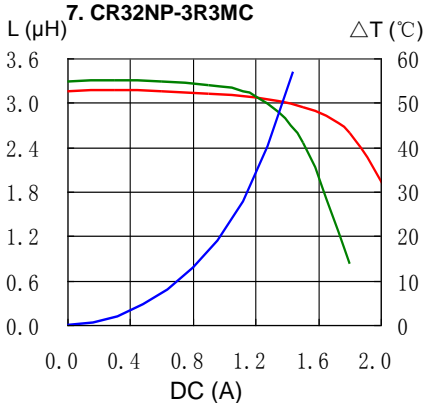
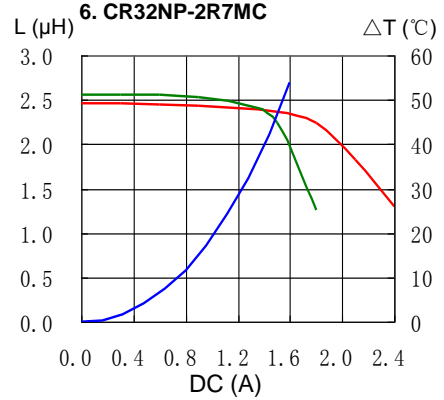
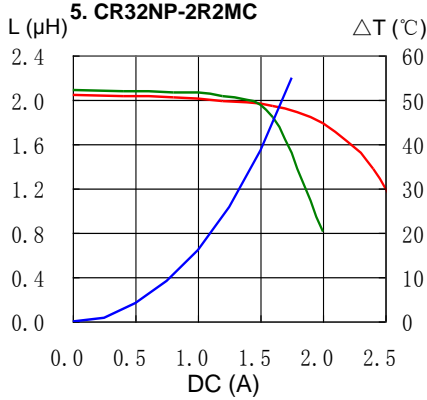
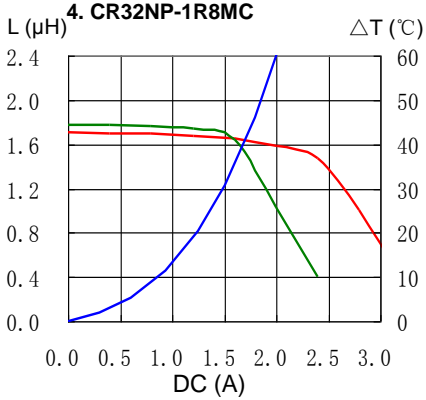
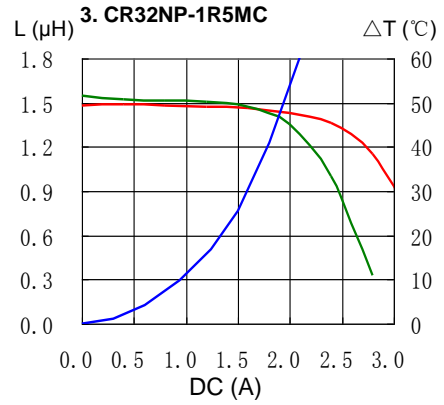
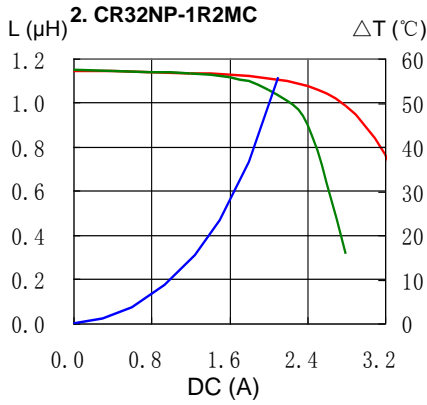
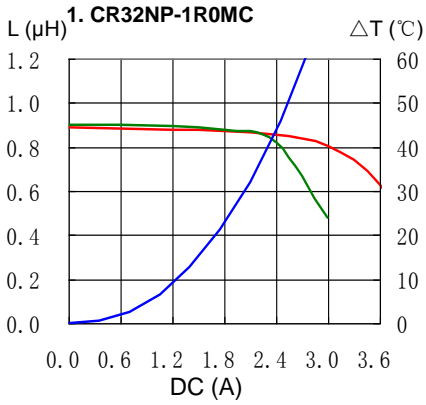

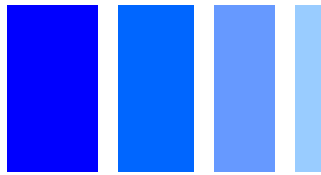

Saturation Current & Temperature Rise Graph

— L (20°C) — L (100°C) — ΔT

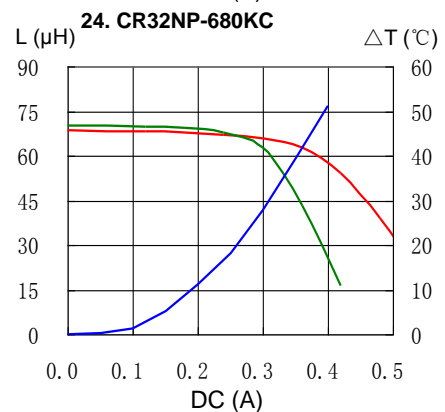
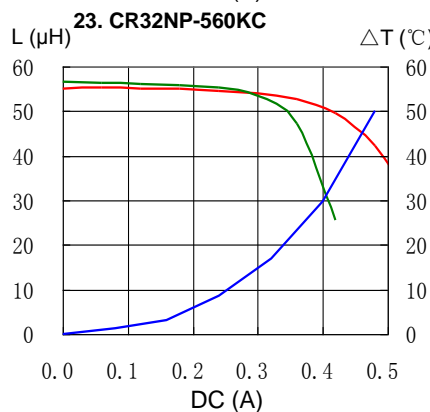
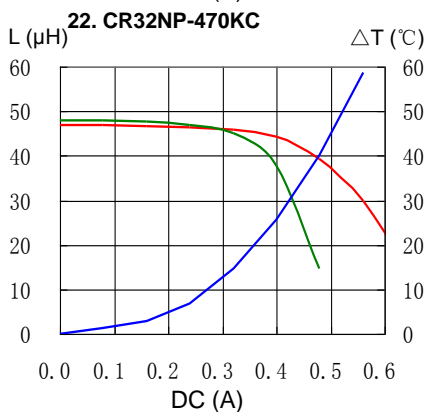
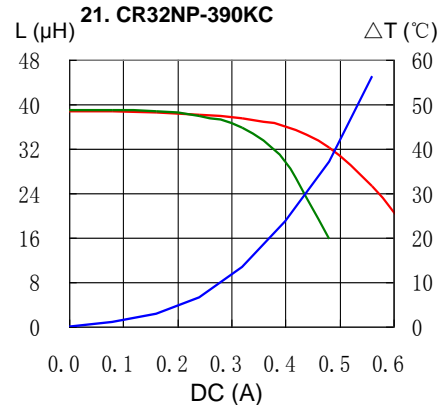
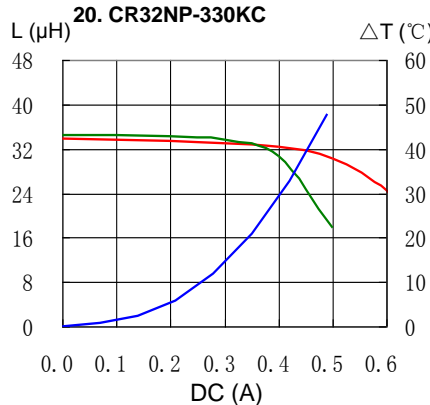
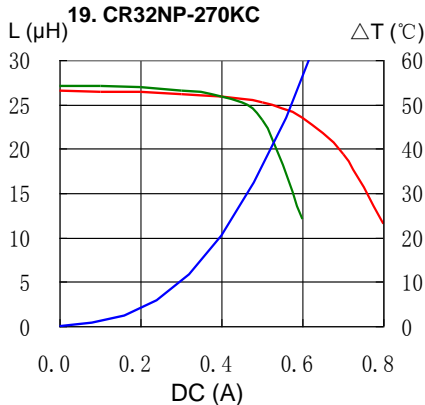
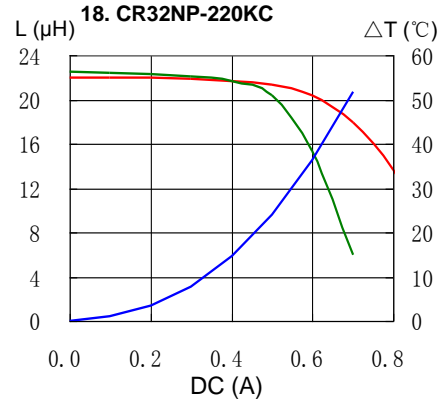
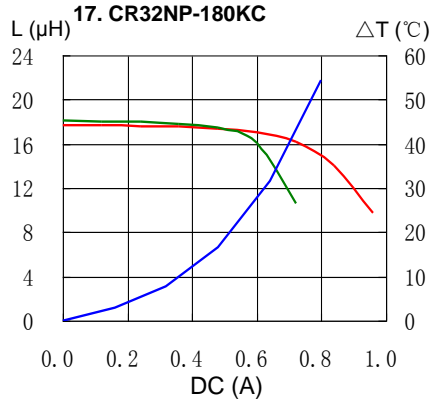
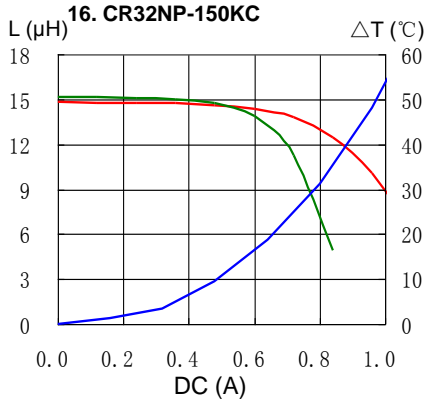
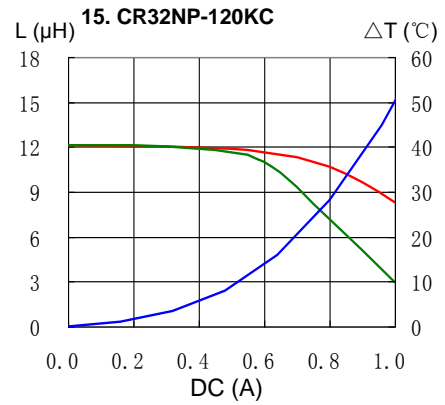
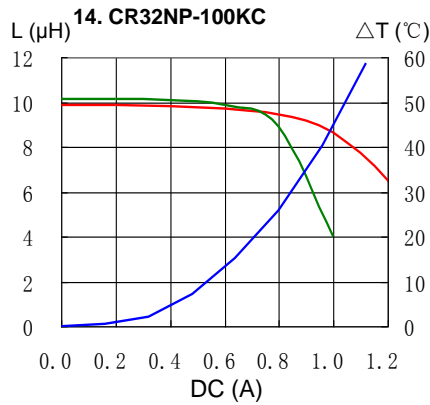
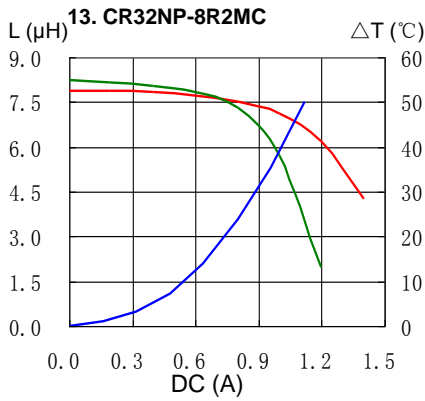

SMD Power Inductor CR32



Saturation Current & Temperature Rise Graph

— L (20°C) — L (100°C) — ΔT

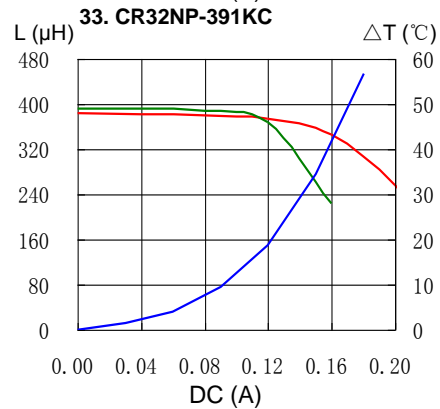
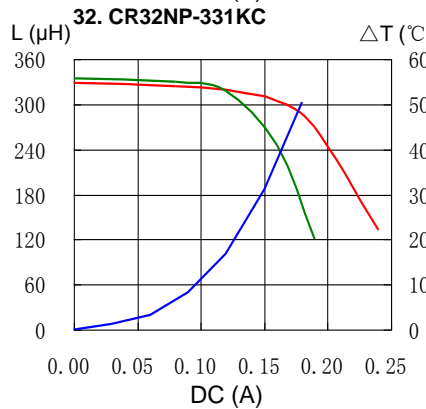
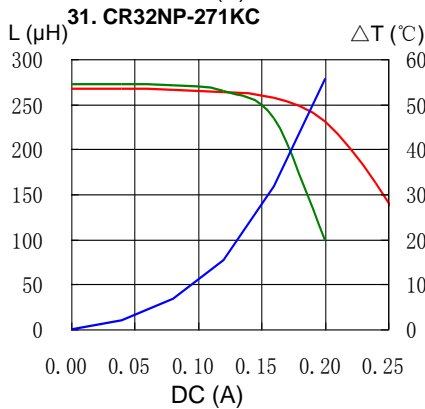
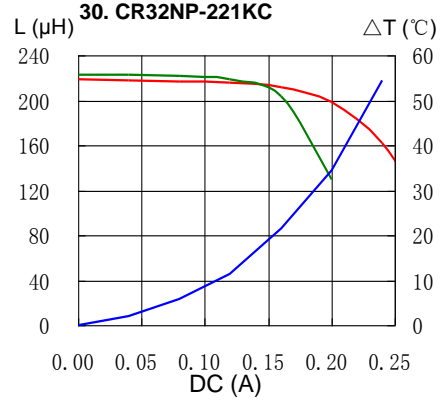
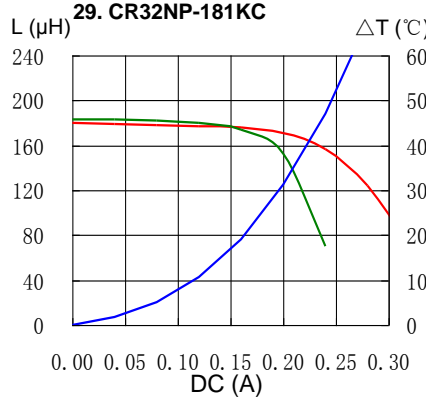
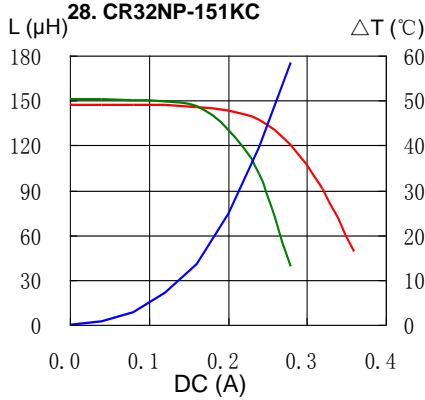
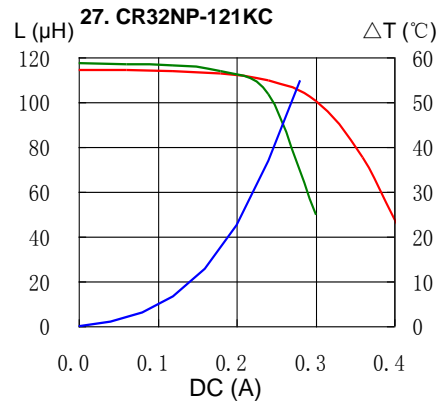
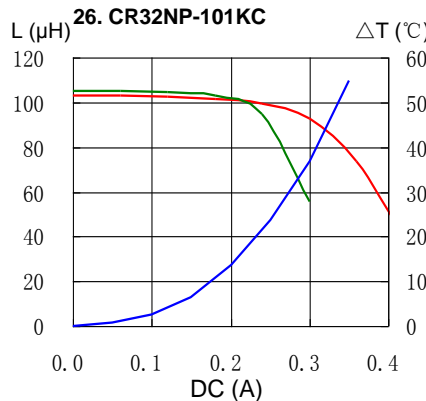
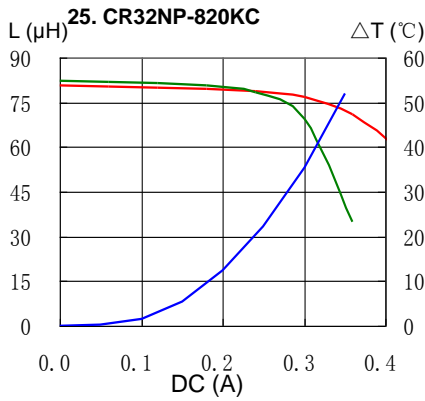

SMD Power Inductor CR32

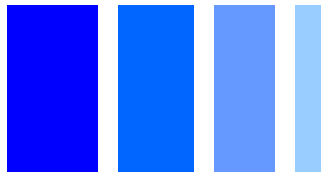

Solder Reflow Condition

Heat Endurance

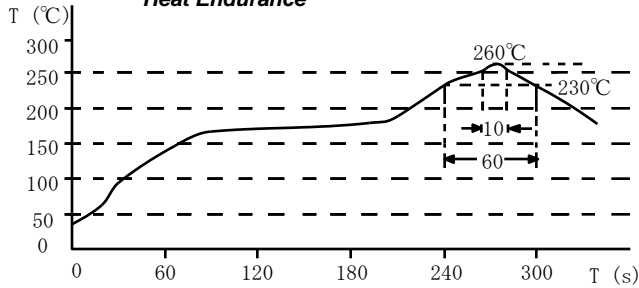

Temperature Chart

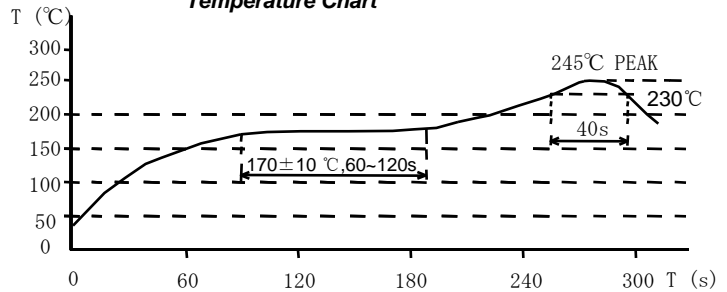

Please refer to the sales offices on our website - <http://www.sumida.com>

Hong Kong

Tel.+852-2880-6781
FAX.+852-2565-9600
sales@hk.sumida.com

Saitama(Japan)

Tel.+81-48-691-7300
FAX.+81-48-691-7340
sales@jp.sumida.com

Chicago

Tel.+1-847-545-6700
FAX. +1-847-545-6720
sales@us.sumida.com

Shanghai

Tel.+86-21-5836-3299
FAX.+86-21-5836-3266
shanghai.sales@cn.sumida.com

Seoul

Tel.+82-2-6237-0777
FAX.+82-2-6237-0778
sales@kr.sumida.com

Obernzell

Tel.+49-8591-937-0
FAX. +49-8591-937-103
contact@eu.sumida.com

Shenzhen

Tel.+86-755-8291-0228
FAX.+86-755-8291-0338
shenzhen.sales@cn.sumida.com

Singapore

Tel.+65-6296-3388
FAX.+65-6841-4426
sales@sg.sumida.com

Neumarkt

Tel.+49-9181-4509-110
FAX. +49-9181-4509-310
infocomp@eu.sumida.com

Taipei

Tel.+886-2-8751-2737
FAX.+886-2-8751-2738
sales@tw.sumida.com

San Jose

Tel.+1-408-321-9660
FAX.+1-408-321-9308
sales@us.sumida.com