

**THRU HOLE TERMINATION
SINGLE ROW
(3 & 4 PIN)**

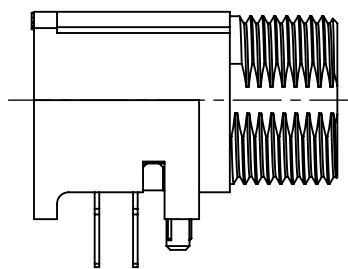

**THRU HOLE TERMINATION
DOUBLE ROW
(5, 6, 7, & 8 PIN)**

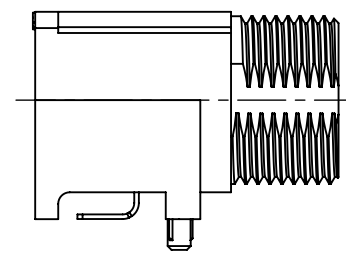

**SURFACE MOUNT TERMINATION
SINGLE ROW
(3 & 4 PIN)**

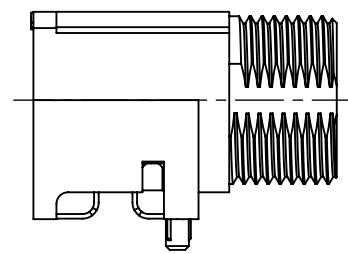

**SURFACE MOUNT TERMINATION
DOUBLE ROW
(5, 6, 7, & 8 PIN)**

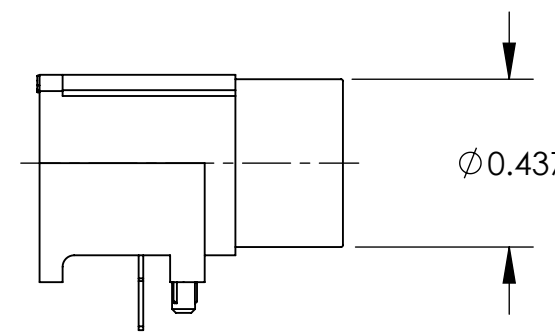

**NO THREAD OPTION
(SINGLE ROW THRU HOLE SHOWN)**

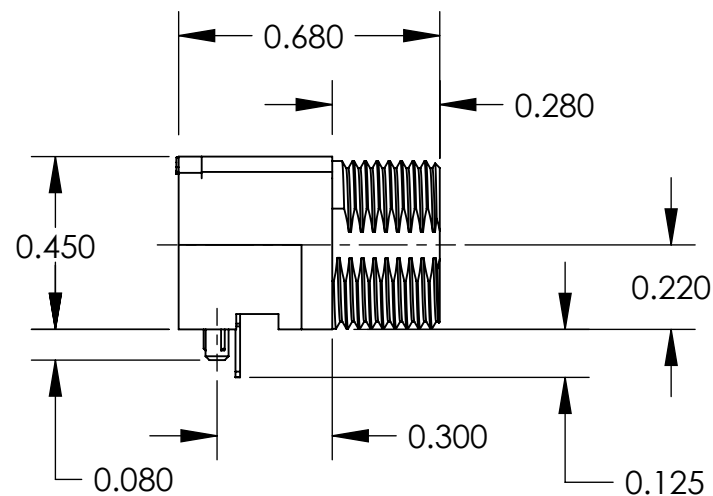

**SMALL PROFILE
THRU HOLE TERMINATION**

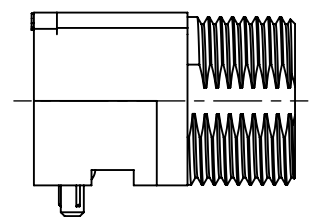

**SMALL PROFILE
SURFACE MOUNT TERMINATION**

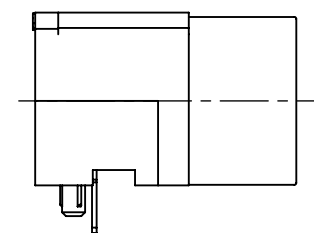

**SMALL PROFILE
NO THREAD OPTION
(THRU HOLE SHOWN)**

TRAPC3MS1T15X

TINI QG

RIGHT ANGLE

TERMINATION

PC = THRU HOLE
SM = SURFACE MOUNT

CONTACT CONFIGURATION

3 THRU 8

CONTACT GENDER

M = MALE

RoHS COMPLIANT

REEL SIZE

OPTIONAL PACKAGING

TR = TAPE AND REEL
(STD PACKAGING - BULK)

OPTIONAL MODIFIER

1 = NO THREAD

OPTIONAL MODIFIER

S = SMALL PROFILE
(AVAILABLE IN CONFIGURATIONS 3 & 4 ONLY)

- NOTES:
 1. THREADED CONNECTORS SUPPLIED WITH HEX NUT AND WASHER.
 2. MATERIALS:
 HOUSING - HIGH GRADE THERMOPLASTIC.
 CONTACTS AND TERMINALS - BRASS, TIN PLATED.
 NUT AND WASHER - BRASS, NICKEL PLATED.
 3. THIS PRODUCT IS RoHS COMPLIANT.

CUSTOMER DRAWING

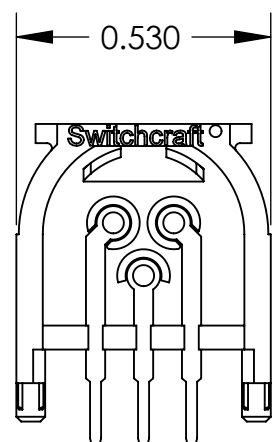

**REAR VIEW
(3 PIN - THRU HOLE SHOWN)**

REV	ECO NUMBER	DATE	BY	APVD
C	27093	2-7-13	TO	TJK
B	26682	5-19-11	TS	TJK
A	26066	7-8-06	TJK	TJK

☆ STAR SYMBOL DENOTES CRITICAL DIMENSION

UNLESS OTHERWISE SPECIFIED

- ALL DIMENSIONS IN INCHES
 - TWO PLACE DECIMALS ±0.01
 - THREE PLACE DECIMALS ±0.005
 - ANGLES ±1°
 - ALL DIA. CONCENTRIC WITHIN 0.005 T.I.R.
- FEATURES ON THE SAME CENTERLINE MUST BE ALIGNED WITHIN ±0.002
- REMOVE ALL BURRS

DO NOT SCALE DRAWING

THIS DRAWING DESCRIBES A DESIGN CONSIDERED PROPRIETARY IN NATURE, DEVELOPED AND MANUFACTURED BY SWITCHCRAFT INC. AND IS RELEASED ON A CONFIDENTIAL BASIS FOR IDENTIFICATION PURPOSES ONLY.

SIZE	WIDTH	MULT	LBS/M	TEMPER
FINISH		MATERIAL		
SPEC No.		SPEC No.		
FIRST USED ON		SCALE 2:1		
DATE DRAWN	BY	CHKD	APVD	Switchcraft [®]
6-9-08	TJK	TJK	TJK	
NAME				PART No.
TINI QG CONNECTOR				TRAPC_X - TRASM_X SERIES
RIGHT ANGLE, PIN CONTACT, RoHS				REV C

SolidWorks CAD File **B**

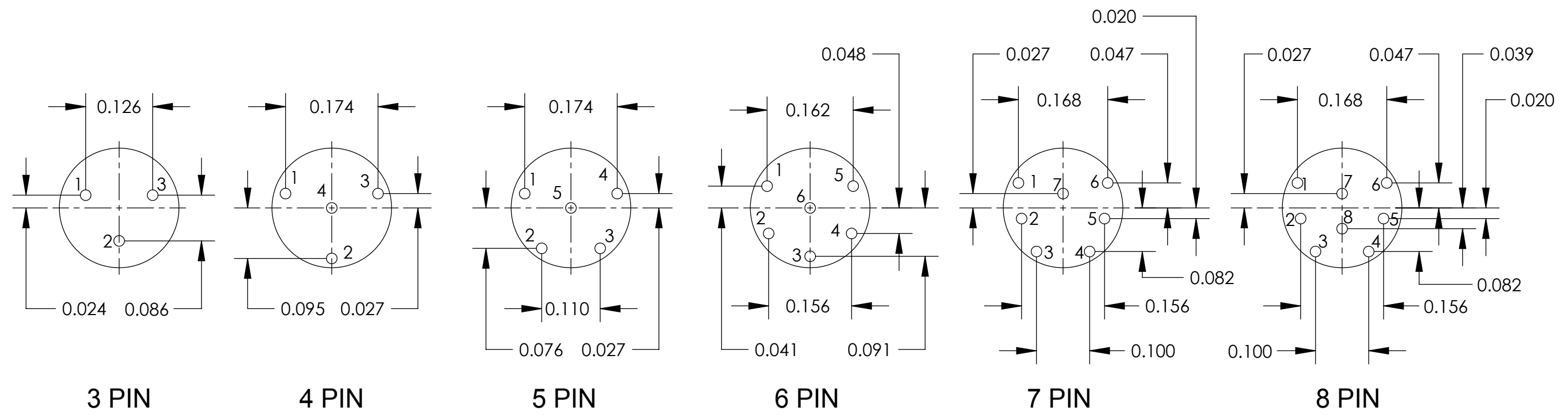

CONTACT CONFIGURATIONS (FRONT VIEW)

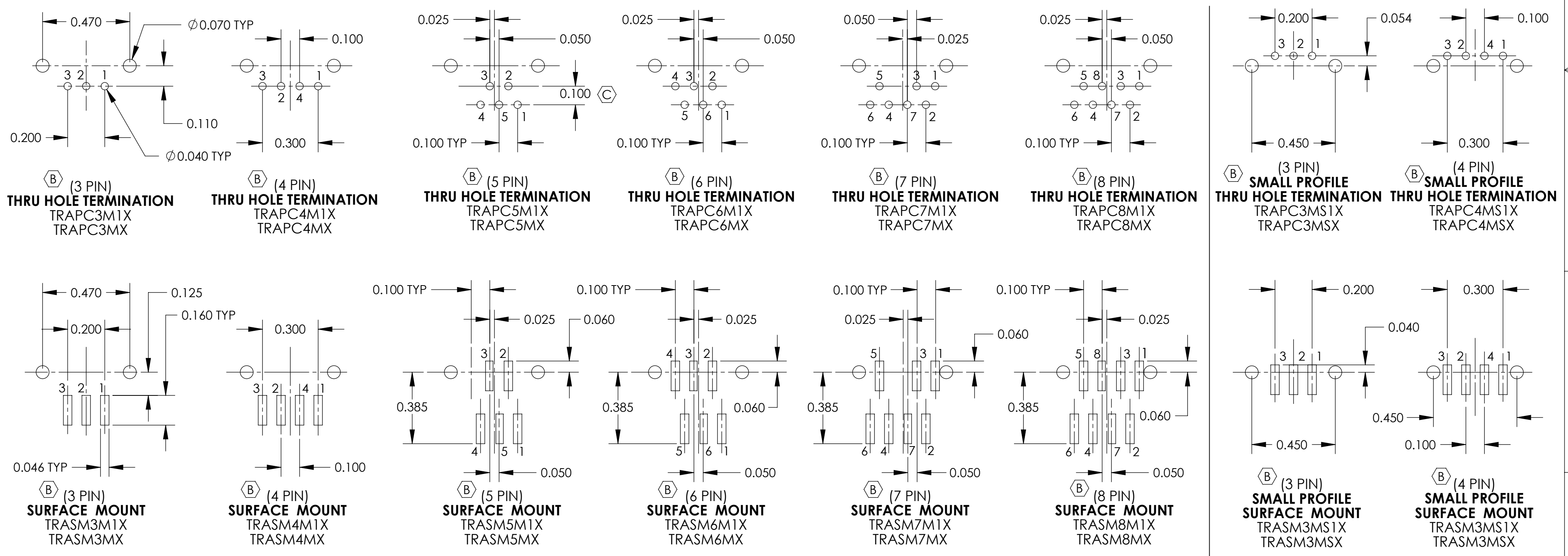

RECOMMENDED PC BOARD LAYOUTS

SCALE 1:0.4	Switchcraft®	
DATE DRAWN 6-9-08		
DRAWN BY TJK	PART No. TRAPC_X - TRASM_X SERIES	REV C