



**AFTERMARKET
PRODUCTS
CATALOG
2016**



**Power Distribution | Relays | Solenoids
Switches | Fuses & Fuse Holders**

Local Resources for a **GLOBAL** Market

Littelfuse products help protect, control and distribute vehicle electrical power in OEM and aftermarket applications for industries such as heavy-duty truck, construction and agriculture.

We offer a broad and reliable selection of fuses, fuse blocks, power distribution modules, high-current switches, relays and solenoids to fit your requirements.

For decades, we have helped OEMs, engineers and end-users select the right product for their applications. Today, Littelfuse offers the broadest range of products for protection, sensing, and control needs while providing exceptional service and support that our customers expect.

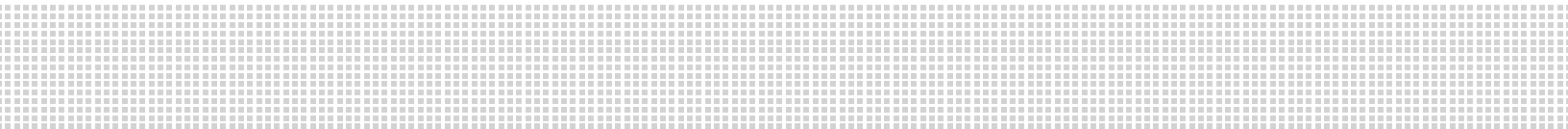
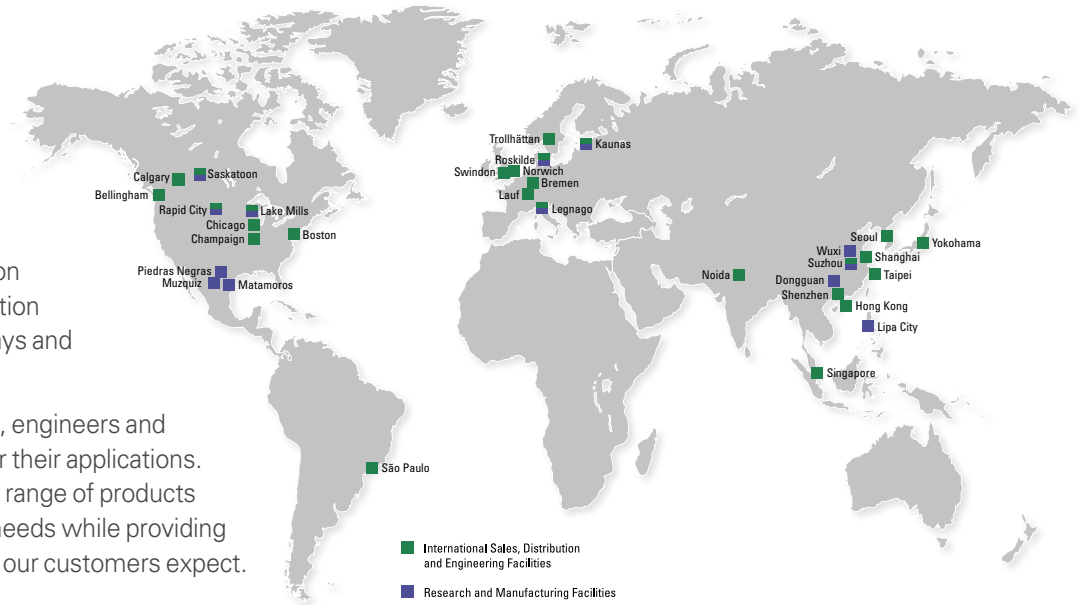

Nearly 90 Years of Electrical Power Expertise

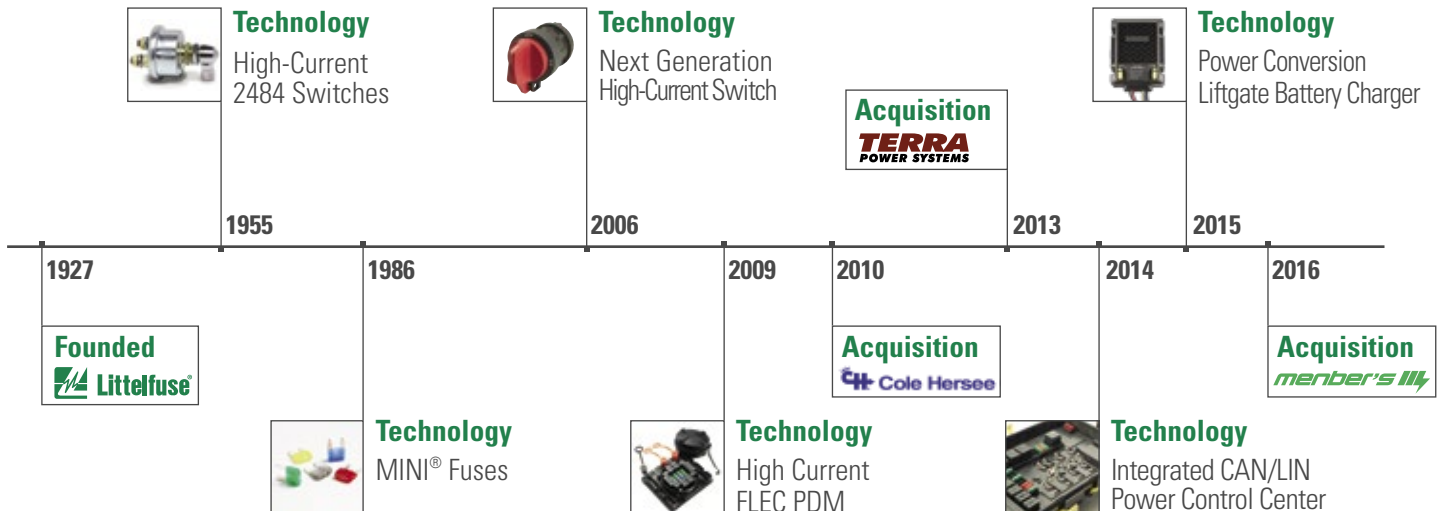

Our Market Focus **INDUSTRIES** and Applications



Truck & Bus

- On-Highway
- Severe Duty
- Transit Buses
- Vocational



Material Handling

- Fork Lifts
- Telehandlers
- Aerial Work Platform
- Pallet Jacks



Construction

- Loaders
- Skid Steers
- Excavators
- Cranes



Municipality

- Emergency
- Waste Trucks
- Fire & Rescue
- Utility



Agriculture

- Tractors
- Harvesters
- Lawn Turf
- Loaders



Marine & Recreational

- Boats & Marine
- Golf Carts
- Recreation Vehicles
- ATV & Snowmobiles

Value Added Electrical System Features



Littelfuse Commercial Vehicle Products help add value to your equipment at every stage of its life cycle. Product safety features help keep end-customers protected from hazards and add unique selling features to your equipment. Engineering expertise allows us to create solutions that combine technologies to reduce your system costs. Intelligent solutions and a passion for durable products help to minimize vehicle downtime and raise operator productivity.

Littelfuse.com/Aftermarket



Improve Safety

- Remote Indication & Control
- Built-In Lock-Out & Tag-Out
- Integrated Fusing
- Touch-Safe Features



Reduce Costs

- Combined System Components
- Keyed Harness Connections
- Simplify Installation Features
- Global Supply Base & Production



Minimize Downtime

- AssureLatch™ Technology
- Built-In Cover Tethers
- Self-Diagnostic Features
- Optimized Battery Life

The Worldwide Leader in Circuit Protection

Circuit Protection Today

An overview of today's fuse market . . .

- New vehicles contain 90 to 150 fuses throughout the vehicle in 3 to 4 different fuse blocks. For example, the BMW 750i uses over 150 fuses.
- High amperage products — MAXI, MEGA, MIDI, PAL and JCASE fuses — make up 1 out of every 5 fuses in new vehicles.
- The past decade has produced more automotive circuit protection devices than the entire history of the industry.
- Fuse and circuit breaker applications have grown by 400% in the past 10 years.
- Glass fuses have not been used as a primary original equipment circuit protection device since 1981. Unit movement has been steadily declining, although glass fuses are used in many accessory applications.

Littelfuse partners with every major automotive and heavy-duty OEM. That is why more than 95% of domestic and 70% of foreign new vehicles contain Littelfuse fuses. (Your Customers and Installers will have a Littelfuse fuse in their hand when they need a source to replace a fuse.) Littelfuse has introduced every new fuse in the industry for the past three decades, starting with the ATO blade fuse. Littelfuse holds more than 130 patents on circuit protection devices, more than all the other fuse manufacturers in the world combined. Other fuse manufacturers are licensed by Littelfuse to utilize its product designs and trademarks.

What is Driving the Circuit Protection Market?

The Circuit Protection market is experiencing accelerated growth caused by a combination of powerful forces driving the market. There has never been a better time to invest in the distribution of the Circuit Protection category.

- **One Wire — One Fuse Protection Trend:** Auto manufacturers are moving towards protecting every wire in the vehicle.
- **More Power Consumption:** Vehicles are consuming power at higher amperages than ever before, and manufacturers are now protecting high amp applications, such as the alternator, with MEGA, MIDI, PAL, JCASE and MAXI fuses.
- **Space & Weight Efficiency:** As vehicle designs get more complex, fuses must get smaller so more fuses can fit in the same amount of space.
- **Greater Diversity of Fuses:** Vehicles contain more fuses than ever before, so Aftermarket Customers and Installers are requiring a greater variety of circuit protection devices in their displays, assortments and merchandisers.
- **More On-Board Electronics:** Auto manufacturers and Aftermarket suppliers are offering a broader range of on-board components like cellular phones, CD players, Bluetooth, navigation, alarm systems and remote starters which require circuit protection for installation and replacement.

- **New Market Niches:** The increased demand in circuit protection is offering current channels of distribution new marketing opportunities in the Fast Lube, Warehouse Club and Electrical Accessories Installer channels or any outlet stocking electrical replacement parts.
- **Longer Vehicle Life:** The life expectancy of cars is increasing to 20+ years. This results in more miles driven and wiring that is aging, leading to more blown fuses that need to be replaced.
- **Easier Access to Fuse Blocks:** Auto manufacturers have moved fuse blocks into the passenger compartments, e.g. glove box, dashboard and trunk, making it easier for DIY replacement. Fuse blocks are also better marked for easier identification of the proper circuit.
- **Infotainment:** The increasing use of video and other new electronics in vehicles have challenged designers to protect even more sensitive automotive electronics. New technologies in circuit protection and fuse box design eliminate transient surges that can damage vehicle equipment.

The Future of Circuit Protection

The Littelfuse new product development process is based on practical innovations designed around the needs of the customer. The circuit protection products of the future will offer greater features to protect increasingly complex electrical systems, meet the booming demand for on-board electronics and make the Circuit Protection category a continuously stronger part of the Automotive Aftermarket.

Here is a glimpse of the Littelfuse vision of circuit protection for tomorrow . . .

- Fuse count per vehicle to grow each year.
- Increased need for higher amp protection with MCASE and bolt-on devices like MEGA and MIDI fuses.
- Greater need for a broader range of fuse blocks and fuse holders, testers and pullers, fuse kits and assortments and creative merchandising systems.

- Greater need for more technical training materials, point of sale education support and more reliable application data.
- More compact fuses such as MINI, Micro and electronic surface mount fuses.
- Smart circuit protection — the vehicle will tell you what fuse needs to be replaced and its location.
- Special circuit protection products designed for electric and alternative fuel vehicles.
- Modular electrical systems that require modular fuse blocks in locations throughout the vehicle like the quarter panels, fender wells, door panels, etc.

Table of Contents

Circuit Protection - Fuses & Circuit Breakers

Fuse Selection Chart	2
Fuseology	3-4
Retail Information, Packaging & Part Numbers	5-7
Blade Fuses	8-10
Cartridge Fuses	11
Bolt-Down Fuses	12
Auto Link Fuses	13
Glass Fuses	13-14
Ceramic Fuses	14
Circuit Breakers	16-20
Fuse Assortment Kits	21-26
Specialty Fuse Products	27
Fuse Cross-Reference Guide	28



Power Distribution Modules

Hard-Wired Boxes	30-31
Power Distribution Modules	31-32



Fuse Blocks & Holders

Bolt-Down Fuse Blocks	34
In-line Fuse Holders	35-38
Multiple Position Fuse Blocks	39-40
Power Feed	41
Fuse Pullers and Battery Accessories	42



Battery Management

Battery Isolators	44
Battery Combiners & FlexMod Devices	45
Low Voltage Disconnects	46
Liftgate Battery Chargers	46



Relays & Solenoids

Solid State Relays	48
Standard High Current Relays (Solenoids)	49-51
Bi-Stable Latching Relays	52
Plug-In Relays & MicroRelays	53-54



Battery & Master Disconnect Switches

Master Disconnect Switches	56
Standard Master Disconnect Switches	57-59
Battery Disconnect Switch Accessories	60



Ignition Switches

Ignition Switches	62-64
Special Purpose Ignition Switches	65-66
Ignition Switch Accessories	66



Rocker Switches

Sealed Rocker Switches	68-72
Rocker Switch Accessories	72
Standard Heavy Duty Rocker Switches	73
Dual & Wide Body Rocker Switches	74



Toggle Switches

Toggle Switches	76-82
Toggle Switch Accessories	82
Switch Reference Guide	83
Switch Wiring Diagram	84



Momentary Switches

Momentary Push-Button Switches	84-86
Door Switches	87-88



Push-Pull, Rotary & Foot Switches

Push-Pull Switches	90-91
Rotary Switches	91-92
Foot Switches	93
Rotary Headlamp Switches	94
Rotary Wiper Switches	95-96
Backup & Neutral Safety Ball Switches	97
Stoplamp Switches	98



Vehicle Connectors

Tractor-Trailer Connectors	100-104
Trailer Connectors	105
Connector Mounts & Accessories	106



Indicator Devices

LED Pilot Lights	108
Incandescent Pilot Lights	109-110
Panel Lamps and Base Sockets	111
Buzzers and Alarms	112



Appendix

Alphanumeric Part Number Index	113-116
Notes	116-117

Circuit Protection



What Type of Fuse do I Need?

DC (automotive) fuses are offered in two basic forms: Blade or Bolt Down.

Blade – can be hand inserted into a fuse holder. These fuses provide protection for several amperage ratings up to 70A. They are well suited to protect smaller to medium diameter wires that are usually some distance from the battery. Single blade fuse holders are often called ‘In-Line’ fuse holders as they are spliced into the wiring. Remember to place the fuse holder as close to the battery and as far away from the load as possible. Littelfuse blade fuses include: Micro 2, Micro 3, mini, LP mini, ATO, Maxi, mCase, mCase +, J Case and LP JCase. We offer fuse holders for many of these fuses.

Bolt Down – need to be secured to the fuse holder with a screw or nut/bolt. These fuses provide protection from 30A to 500A. They are well suited to protect medium to large diameter wires that are usually closer to the battery. Ring terminals are crimped onto cables that are connected to these holders and spliced into the wiring. Remember to place the fuse holder as close to the battery and as far away from the load as possible. Littelfuse bolt-down fuses include: MIDI, MEGA, CF8 and Z-Case. We offer fuse holders for many of these fuses.

Also, there are still a wide variety of applications that use glass tube fuses. These are typically lower current values and are becoming less popular for most automotive applications due to their size, form factors, and lack of color coding.

It Glows When it Blows!

SmartGlow fuse technology makes identifying an open circuit quick and easy. Inside a fuse box, it can be difficult to locate which fuse in an array has blown. You can easily identify the SmartGlow because it lights up, indicating the need for replacement. Available in MINI®, ATO®, and MAXI® blade fuses.

Do you Offer Fuse Holders?

Littelfuse offers a wide variety of fuse holder and power distribution modules in different configurations to meet unique needs. Please see the Power Distribution Modules or Fuse Blocks & Holders sections of the catalog to select a product that fits your application requirements.

FUSE SELECTION CHART

TYPE	MICRO2	ATO®	MINI®	MCASE®	JCASE®	MAXI	MEGA®	PAL Series 0	PAL Series 1	PAL Series 2	PAL Series 3	PAL Series 4	PAL Series 5
ACTUAL SIZE													
			Low Profile MINI®		Low Profile JCASE®	SMART GLOW REWORKABLE							
			SMART GLOW REWORKABLE			SMART GLOW REWORKABLE							
Black		1A							80A	80A			
Gray		2A	2A	15A				120A	120A	120A			
Violet		3A	3A			100A				140A			
Pink		4A	4A	30A		70A		30A	30A	30A	30A		
Tan		5A	5A										
Brown		7.5A	7.5A							70A			25A
Red		10A	10A	50A		50A		50A	50A	50A		50A	
Blue		15A	15A	20A		60A		20A	100A	100A		100A	
Yellow		20A	20A	60A		20A		60A	60A	60A			
Clear	MICRO2 ONLY	25A	25A	25A		80A							
Green	MICRO2 ONLY	30A	30A	40A		30A				40A		40A	30A
Orange	MICRO2 ONLY	40A				40A							
White				25A									120A

GLASS

AGU
AGY, SFE30

AGC, SFE20, UK

SFE14

AGW, SFE7.5, SFE9

AGA, SFE4

SFE6



Fuseology

1

Understanding how circuit protection works is a key to diagnosing automotive electrical problems. When a fuse blows, that means the fuse is doing its job — sending you a message that something needs to be fixed.

WHAT IS THE PURPOSE OF A FUSE?

A fuse is a safety valve. It is designed to stop current from exceeding the rating of the wires or components. Without fuses, excessive current could cause damage to electrical systems, and even result in fires.

In general, a fuse has a simple construction. The key component is the “element” — a short piece of metal wire or strap.



WHAT CAUSES A FUSE TO BLOW?

The element is designed to melt at a specific temperature, to protect wires and equipment from overcurrents. An overcurrent is any current that exceeds the amperage rating or wiring capacity of equipment or devices under normal

conditions of use.

If an overcurrent causes the current in a circuit to rise above a specific level — often the circuit’s rating — the heat produced will melt the fuse’s element, causing the fuse to “blow.” This opens the circuit and immediately stops the flow of current. Fuses are designed to blow at temperatures far below those that would cause damage or hazards.

Once a fuse is blown, it can be replaced to allow the current to flow again.

But simply replacing a fuse may not be the solution to the problem.

In fact, there is a chance the fuse will just blow again, because the fuse is signaling a problem in the system. Understanding the factors that cause a fuse to blow will help you diagnose automotive electrical problems.

There are two types of overcurrents that can cause a fuse to blow: overloads and short circuits.

Overload

What: The current exceeds the amperage at which the wires or equipment are rated.

Why: Too many devices are connected to one circuit, or a device malfunctions and draws higher than its normal operating current. Sustained overloads cause overheating of circuit components and the fuse blows.

Short Circuit

What: The current is out of its normal path.

Why: A malfunction creates an unintended path for electricity to flow from the battery or alternator to ground. This can be caused by the touching of any positive wire to a ground wire, e.g. due to frayed wire insulation, or tools laid across the positive and ground wires of a circuit. The uncontrolled current to ground then surpasses the normal resistance of the wire contained in the circuit, forcing higher and higher current to the point of the generating heat which blows the fuse.

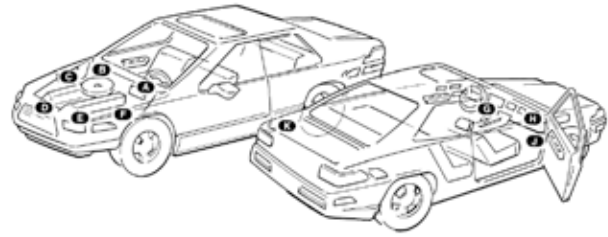

Bold letter indicates fuse block location.

A Left fire wall	G Behind/under dash left
B Right fire wall	H Behind/in glove box
C Right fender	J Behind/under dash right
D Right front	K Rear compartment
E Left front	IL In-line with device protected
F Left fender	(locations may vary from car to car, see your dealer.)

FINDING A FUSE

To be able to address fuse issues, you first must be able to locate the appropriate fuse within the vehicle. In today’s vehicles, each individual wire is protected by a circuit protection device.

Fuses are contained in fuse blocks located at various points throughout the vehicle. The diagram above illustrates typical fuse block locations. For further help finding a fuse, use the *Littelfuse Automotive Fuse Guide*, which lists a letter corresponding to the fuse location for every fuse application listed.

SELECTING THE RIGHT FUSE

Once you have found the fuse that has blown, and solved the problem in the vehicle, you must replace the blown fuse with an appropriate device.

When selecting the right fuse for replacement, you should consider the following:

Physical Type

The replacement fuse must be of the same physical type as the blown fuse being replaced. It must be of the same style and have the same dimensions so that it can fit properly in the fuse block or fuse holder. Check your owner’s manual to determine the appropriate fuse type.

Installation Tip: Littelfuse holds patents for the designs on most automotive fuses. It is important to remember that the physical type of the fuse is important, but it is not the only factor affecting the fuse’s function. Although some fuses appear to be the same type and dimension as Littelfuse fuses, they do not necessarily have the same performance characteristics.

Look for the Littelfuse OEM Label

To guarantee the same level of quality in circuit protection that the major automotive manufacturers of North America require for their original equipment fuses, look for the OEM seal on Littelfuse aftermarket products. Only Littelfuse products can guarantee this level of quality.



Fuseology

Beware of Counterfeit Fuses

At first glance, it's hard to tell the difference between a genuine Littelfuse blade fuse and a counterfeit. The counterfeit may have the same physical dimensions, but using it can be dangerous because it fails to perform to the stringent performance and safety specifications developed by Littelfuse and the OEMs.

In many cases, the elements in counterfeit fuses do not correspond with the amperage specification stamped on the fuse. This will prevent the elements from opening at the rated or correct amperage, which could result in an auto fire causing serious damage to the vehicle, its contents and its passengers.

Responding to this growing problem, the United States International Trade Commission and then President Ronald Reagan issued and approved an exclusion order in 1983 prohibiting the importation of the look-alike blade fuses into the United States. This order was initiated because many of these fuses were proven to be totally unsafe. The photos shown here indicate why counterfeit fuses are potentially unsafe and present a fire risk.

To guarantee quality and safety, look for the Littelfuse name on fuses and fuse packaging.



Current Rating – Amperage

The current rating, marked on every fuse, is the maximum current in amperes that the fuse can continuously carry under specified conditions.

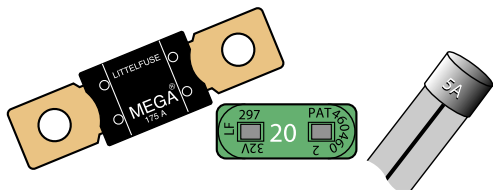

Tip: When selecting a fuse, make sure the current rating of the fuse is the same amperage as the circuit. You can obtain the current rating of a circuit by looking in the owner's manual of the vehicle; checking to see if it is written on the fuse block; or consulting the Littelfuse Fuse Guide.

Overfusing and Underfusing

Overfusing is when the fuse has a current rating higher than the rating of the circuit. In this case, the fuse will not be able to protect the circuit properly because the circuit could reach overcurrent levels, causing damage and safety hazards, before the fuse would blow.

Underfusing is when the fuse is rated at a current too far below the rating of the circuit. In this case the fuse will blow, even though the circuit is functioning normally without an overcurrent. Underfusing almost guarantees that a fuse will blow repeatedly. This is referred to as a nuisance blow.

Voltage Rating

The voltage rating, marked on every fuse, indicates the maximum voltage at which the fuse is designed to operate safely if an overcurrent occurs.

Tip: The fuse voltage rating must equal to or exceed this circuit voltage where the fuse is installed. This is not a problem in fuse selection because automotive fuse applications are typically around 12 volts, while the voltage rating of the majority of Littelfuse automotive fuses — including ATO Fuse, MINI Fuse, MAXI Fuse and MEGA Fuse — is 32 volts.

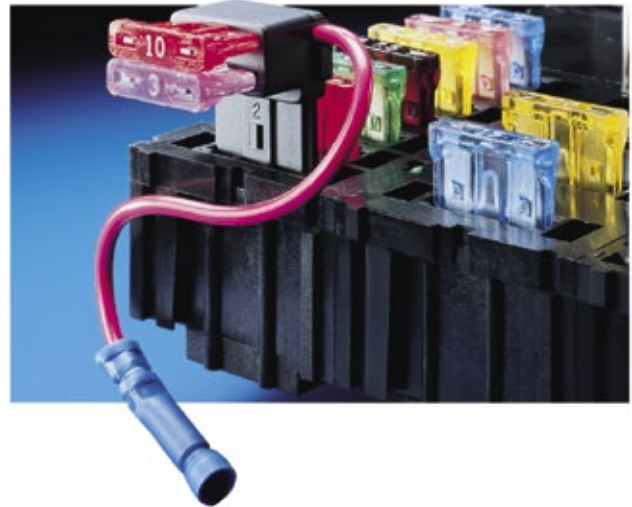

ADDING A CIRCUIT

Always use a circuit protection device with a fuse holder or fuse block whenever adding additional circuits to ensure optimal safety. The fastest, easiest option for installers who need to add a circuit for applications such as electronic components, is the Littelfuse Add-A-Circuit Fuse Holder. Add-A-Circuit, available in ATO® and MINI® blade fuse versions, is designed to facilitate installation of fuses for accessories of 10 amps or less. The Add-A-Circuit adapts the fuse block to the installer's needs, quickly turning one slot in the fuse block into two, providing a safe, economical alternative to splicing or fusetaps.

Caution: Fusetaps are not a recommended alternative for adding circuits because they can overstress the terminals in the fuse block. This situation can create a loose fitting fuse, which in turn produces excessive heat, which can cause nuisance blows, even melting of the fuse and fuse block and possibly an expensive repair in the future. When a fusetap is used, in many cases there is no fuse protecting the new circuit, a condition which can also present a hazard.



Another alternative to adding a circuit is the Littelfuse Battery Power Feed (BPF1). This device attaches directly to the battery terminal, allowing the addition of up to three circuits. Then use an in-line fuse holder to protect the circuit properly.

Retail Information

1



Planogram

We developed the next generation of Retail Circuit Protection. You now can fit more product in the same planogram space — 36% more.

MORE SPACE

for higher margin kits and assortments.

OVER 70% GREATER PROFIT POTENTIAL

per square foot with additional SKU's

DOUBLE PLANOGRAM PERFORMANCE

100% increase in retail dollar sales per square foot

INCREASE MARKET COVERAGE

with high amp JCASE, MAXI and PAL Auto Link fuses

**ORIGINAL
EQUIPMENT
MANUFACTURER**

OEM SYMBOL

Prominent on package assures consumers of quality and actual OE replacement.

COLOR CODED

for easier stocking and consumer selection.

RECLOSABLE

Keeps key marketing data with package until completely consumed.

MULTI-LINGUAL

One SKU covers US, Canadian, German and Latin American markets.

MATERIAL NUMBER	CATALOG NUMBER	DESCRIPTION
00940477Z	094477	Our 87 SKU, 510-piece pre-pack Plan-O-Gram includes full blade-fuse coverage, as well as expanded coverage into newer parts such as Low-Profile MINI, Low-Profile JCASE, MICRO2, MICRO3, MCASE and Emergency Kits. Includes blade fuses, glass fuses, circuit breakers, Assortment and Emergency kits, fuse holders and fuse tester/pullers. Measures approximately 36"x36".
00940478Z	094478	Our 103 SKU, 625-piece pre-pack Plan-O-Gram is our largest retail assortment featuring multiple facings of the most popular items. This assortment expands your line coverage to fill the needs of your DIY and professional dealer/installer customers as well. Measures approximately 48"x32".

Graphic Header Cards

An attractive header card is available for Littelfuse Circuit Protection product displays. Measures 36" wide x 8" high or 48" X 8" high.

MATERIAL NUMBER	DESCRIPTION
AA979	36" X 8" Display Header for 36" Planogram (PART# 00940477Z)
AA980	48" X 8" Display Header for 48" Planogram (PART# 00940478Z)



Retail Information

Packaging / Part Numbering

Bulk Carton

The outer corrugated cardboard box that holds several cartons.



Carton

The outer corrugated cardboard box that holds several inner packs, or bulk fuses (no inner packs).

Blister Pack

A retail package containing one or several identical products, such as fuses, or it may contain an assortment of fuses. Blister packs are designed to fit on a peg-hook. 'Bubble pack' or 'clamshell' packages are blister packs.

Inner Pack

A small chipboard box containing several blister packs or pillboxes.

Pill Box

A small plastic box containing fuses. Pillboxes are snap-shut resealable.

Fuse Packaging

1

Standard Fuse Packaging

BOXED MERCHANDISE	PIECES/BOX	STANDARD PACK	ORDER
ATO®, MINI® Fuses	5 to a box	100 (twenty 5 packs)	by piece
Glass Ceramic Fuses	5 to a box	50 (ten 5 packs)	by piece
AGU Fuses	10 to a box	10 (one 10 pack)	by piece
MAXI, PAL, MEGA®, MIDI®	1 to a pack	10	by piece
Flashers, Circuit Breakers, Fuse Holders	1 to a pack	10	by piece
RETAIL PACKAGED MERCHANDISE	FUSES/CARD	STANDARD PACK	ORDER
ATO®, MINI® Fuses, Glass, Ceramic Fuses	5 to a card	5 cards/shelf pack	by card
MAXI, PAL, MEGA®, MIDI® Fuses	1 to a card	5 cards/shelf pack	by card
Plus Packs	25	5 cards/shelf pack	by card
Retail Carded Kits and Assortments	Various	5 cards/shelf pack	by card
Assortments, Jobber Boards, Merchandisers, etc.	Various	Single unit	by unit

Examples of order numbers

Order numbers must have between 9 characters and 15 characters. These are for added description, such as ZXPRO. When you place an order, write or type the characters without a break in the string.

0ATO 010. VP

First set of four
"ATO Fuses"

Second set of four
"10 Amps"

"Retail pack of 5"

OMIN 030. ZXPRO

First set of four
"MINI Fuses"

Second set of four
"30 Amps"

"Professional Pack"

Mandatory characters

First set of four:

These identify the product group, like LMIN (Low profile MINI fuse) or OMAX (MAXI fuses).

Second set of four:

These identify the product subgroup. In fuses, this usually identifies the amperage. The decimal point counts as one character, eg 010. = 10A, 100. = 100A, 01.5 = 1.5A.

9th character:

Inner pack quantity. See list of codes below.

Inner Pack Codes

Quantity Code

1 = X	500 = U
5 = V	1,000 = M
10 = T	1,500 = D
20 = S	2,500 = E
50 = L	3,000 = W
100 = H	4,000 = Y
200 = F	5,000 = N
250 = G	10,000 = K

Optional characters

10th Character

Packaging type. P= Retail pack, B=Blister Pack.

Last set of 5:

May be used to give additional information such as, MXGLO for SmartGlow fuses

Blade Fuses



MINI® • 2-30A • Standard and Smart Glow Blade Fuses

The MINI® Fuse is quickly becoming the new standard for vehicle circuit protection. Its miniature design meets the need for more circuits to be protected while utilizing less space, and its ability to cope with high temperatures in adverse environments makes the MINI® Fuse the recommended choice for protection. Smart Glow fuses are innovative automotive style fuses that feature an indicator light that glows when the fuse is blown, saving time to troubleshoot an open circuit.

Additional information: littelfuse.com/MINI

Standard: Voltage Rating Characteristics: 32V AC/DC Fast-Acting, Approvals: UL listed, SAE J2077.

Smart Glow: Interrupting Rating: 1000A @ 14V DC, Voltage Rating: 12V DC, Operating Temperature Range: -40°C to +125°C, Terminals: Silver plated Zinc alloy



COLOR CODE	CURRENT RATING (A)	BOXED	CARDED	CARDED
		MATERIAL NUMBER	PACKAGING MATERIAL NUMBER	PACKAGING MATERIAL NUMBER
Gray	2	0MIN002.V	0MIN002.VP	-
Violet	3	0MIN003.V	0MIN003.VP	0MIN003.VPGLO
Pink	4	0MIN004.V	0MIN004.VP	-
Tan	5	0MIN005.V	0MIN005.VP	0MIN005.VPGLO
Brown	7.5	0MIN007.5V	0MIN007.5VP	0MIN007.5VPGLO
Red	10	0MIN010.V	0MIN010.VP	0MIN010.VPGLO
Blue	15	0MIN015.V	0MIN015.VP	0MIN015.VPGLO
Yellow	20	0MIN020.V	0MIN020.VP	0MIN020.VPGLO
Clear	25	0MIN025.V	0MIN025.VP	0MIN025.VPGLO
Green	30	0MIN030.V	0MIN030.VP	0MIN030.VPGLO

Dimensions MINI®

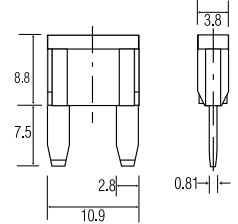

Dimensions SMART GLOW MINI®

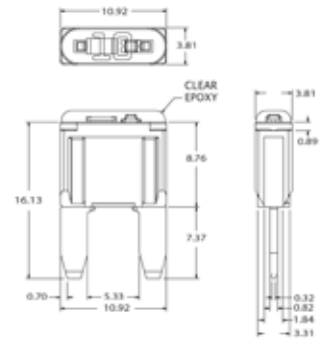

Low Profile MINI® • 2-30A • Blade Fuses

The Low Profile MINI® fuse is designed to mate with tuning-fork terminals, which provides additional weight and material savings in fuse box designs by eliminating the need for female box terminals.

Additional information: littelfuse.com/LPMINI

Voltage Rating: 58V DC, Interrupting Rating: 1000A @ 58V DC, Operating Temperature Range: -40°C to +125°C, Terminals: either Ag or Sn plated zinc, Housing Materials: Nylon composite



COLOR CODE	CURRENT RATING (A)	BOXED	CARDED
		MATERIAL NUMBER	PACKAGING MATERIAL NUMBER
Gray	2	LMIN002.V	-
Tan	5	LMIN005.V	LMIN005.VP
Brown	7.5	LMIN007.5V	-
Red	10	LMIN010.V	LMIN010.VP
Blue	15	LMIN015.V	LMIN015.VP
Yellow	20	LMIN020.V	LMIN020.VP
Clear	25	LMIN025.V	LMIN025.VP
Green	30	LMIN030.V	LMIN030.VP

Dimensions Low Profile MINI®

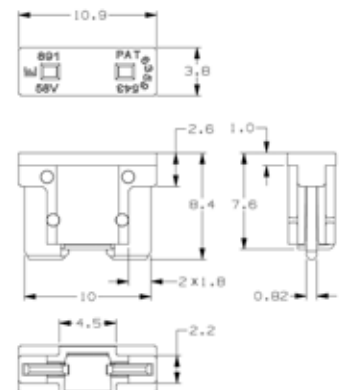

Blade Fuses

1



ATO® • 1-40A • Standard and Smart Glow Blade Fuses

It is currently found on most cars, trucks, buses and off the road vehicles worldwide. Features Littelfuse designed industry standard color coding to indicate amp rating. Smart Glow fuses are innovative automotive style fuses that feature an indicator light that glows when the fuse is blown, saving time to troubleshoot an open circuit. Additional information: littelfuse.com/ATO

Standard: Voltage Rating Characteristics: 32V AC/DC Fast-Acting Approvals: UL listed, SAE J2077.

Smart Glow: Interrupting Rating: 1000A @ 14V DC Voltage Rating: 12V DC Operating Temperature Range: -40°C to +125°C Terminals: Silver plated Zinc alloy



COLOR CODE	CURRENT RATING (A)	BOXED	CARDED	CARDED
		MATERIAL NUMBER	PACKAGING MATERIAL NUMBER	PACKAGING MATERIAL NUMBER
Black	1	0AT0001.V	0AT0001.VP	—
Gray	2	0AT0002.V	0AT0002.VP	—
Violet	3	0AT0003.V	0AT0003.VP	0AT0003.VPGLO
Pink	4	0AT0004.V	0AT0004.VP	—
Tan	5	0AT0005.V	0AT0005.VP	0AT0005.VPGLO
Brown	7.5	0AT0007.5V	0AT0007.5VP	0AT0007.5VPGLO
Red	10	0AT0010.V	0AT0010.VP	0AT0010.VPGLO
Blue	15	0AT0015.V	0AT0015.VP	0AT0015.VPGLO
Yellow	20	0AT0020.V	0AT0020.VP	0AT0020.VPGLO
Clear	25	0AT0025.V	0AT0025.VP	0AT0025.VPGLO
Green	30	0AT0030.V	0AT0030.VP	0AT0030.VPGLO
Orange	40	0AT0040.V	0AT0040.VP	—

Dimensions ATO®

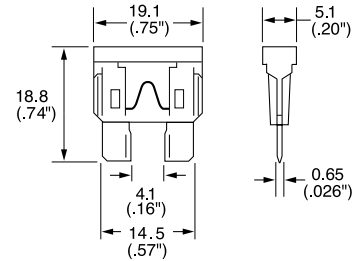

Dimensions SMART GLOW ATO®

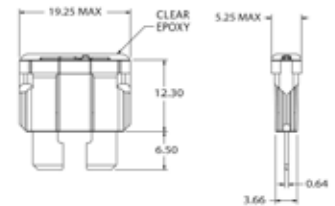

MAXI • 20-100A • Standard and Smart Glow Blade Fuses

MAXI Fuses are primarily used for under hood applications and are produced with a high temperature polymer and silver plated blades. They replace the commonly used fusible wire or fusible link to protect a high current segment or system of the wiring harness. Features Littelfuse designed industry standard color coding to indicate amp rating. Smart Glow fuses are innovative automotive style fuses that feature an indicator light that glows when the fuse is blown, saving time to troubleshoot an open circuit.

Additional information: littelfuse.com/MAXI

Standard: Voltage Rating: 32V DC, Interrupting Ratings: 1000A @ 32V DC, Operating Temperature Range: -40°C to +125°C, Terminals: Ag plated

Smart Glow: Voltage Rating: 32V DC, Interrupting Ratings: 1000A @ 32V DC, Operating Temperature Range: -40°C to +125°C, Terminals: Ag plated



COLOR CODE	CURRENT RATING (A)	BOXED	CARDED	CARDED
		MATERIAL NUMBER	PACKAGING MATERIAL NUMBER	PACKAGING MATERIAL NUMBER
Yellow	20	0MAX020.X	0MAX020.XP	0MAX020.XPGLO
Green	30	0MAX030.X	0MAX030.XP	0MAX030.XPGLO
Orange	40	0MAX040.X	0MAX040.XP	0MAX040.XPGLO
Red	50	0MAX050.X	0MAX050.XP	0MAX050.XPGLO
Blue	60	0MAX060.X	0MAX060.XP	0MAX060.XPGLO
Tan	70	0MAX070.X	—	0MAX070.XPGLO
Clear	80	0MAX080.X	0MAX080.XP	0MAX080.XPGLO
Purple	100	—	—	0MAX100.XPGLO

Dimensions MAXI

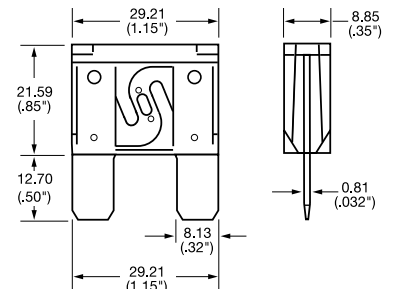

Blade Fuses



MICRO2™ • 5-30A • Blade Fuses

Its sub-miniature design meets the need for more circuits to be protected while utilizing less space and its ability to cope with high temperatures in adverse environments makes the MICRO2™ Fuse the recommended choice for protection.

Additional information: littelfuse.com/MICRO2

Voltage Rating: 32V DC, Interrupting Ratings: 1000A @ 32V DC, Operating Temperature Range: -40°C to +125°C

COLOR CODE	CURRENT RATING (A)	BULK 50 PC	BOXED 5 PC	CARDED 5 PC
		MATERIAL NUMBER	MATERIAL NUMBER	MATERIAL NUMBER
Tan	5	0327005.LXS	MIC2005.V	MIC2005.VP
Brown	7.5	032707.5LXS	MIC207.5V	MIC207.5VP
Red	10	0327010.LXS	MIC2010.V	MIC2010.VP
Blue	15	0327015.LXS	MIC2015.V	MIC2015.VP
Yellow	20	0327020.LXS	MIC2020.V	MIC2020.VP
Clear	25	0327025.LXS	MIC2025.V	MIC2025.VP
Green	30	0327030.LXS	MIC2030.V	MIC2030.VP

Dimensions MICRO2™

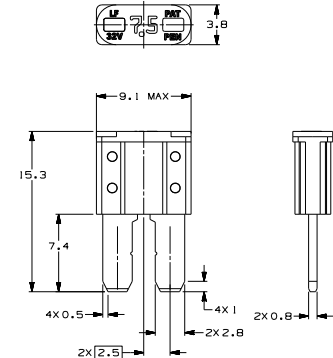

MICRO3™ • 5-15A • Blade Fuses

The MICRO3™ Fuse is the new standard for vehicle circuit protection. The MICRO3™ Fuse has 3 terminals and 2 fuse elements with a common center terminal. Its sub-miniature design meets the need for more circuits to be protected while utilizing less space and its ability to cope with high temperatures in adverse environments makes the MICRO3™ Fuse the recommended choice for protection.

Additional information: littelfuse.com/MICRO3

Voltage Rating: 32V DC, Interrupting Ratings: 1000A @ 32V DC, Operating Temperature Range: -40°C to +125°C

COLOR CODE	CURRENT RATING (A)	BULK 50 PC	BOXED 5 PC	CARDED 5 PC
		MATERIAL NUMBER	MATERIAL NUMBER	MATERIAL NUMBER
Tan	5	0337005.LXS	MIC3005.V	MIC3005.VP
Brown	7.5	033707.5LXS	MIC307.5V	MIC307.5VP
Red	10	0337010.LXS	MIC3010.V	MIC3010.VP
Blue	15	0337015.LXS	MIC3015.V	MIC3015.VP

Dimensions MICRO3™

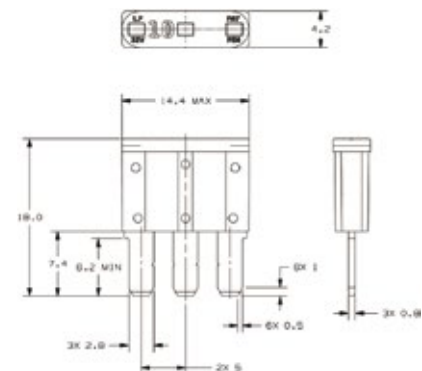

Cartridge Fuses

1



JCASE® • 20-60A • Cartridge Fuses

Smaller space saving footprint is being designed in by many OEM's. Patented technology provides both increased time delay and low voltage drop. Features ANSI standard OCR-A font for visual inspection systems, double spring-beam box terminal and unique secondary locking feature holds terminal firmly in place. Additional information: littelfuse.com/JCASE

Voltage Rating Characteristics: 32V AC/DC Slo-Blo®, Interrupting Ratings: 1000A @ 32V DC, Operating Temperature Range: -40°C to +125°C, Insertion Force: 53N max. (12lb), Extraction Force: 9N min. (2lb)

COLOR CODE	CURRENT RATING (A)	BOXED	CARDED
		MATERIAL NUMBER	PACKAGING MATERIAL NUMBER
Blue	20	JCAS020.X	JCAS020.XP
White	25	JCAS025.X	JCAS025.XPA
Pink	30	JCAS030.X	JCAS030.XP
Green	40	JCAS040.X	JCAS040.XP
Red	50	JCAS050.X	JCAS050.XP
Yellow	60	JCAS060.X	JCAS060.XP

Dimensions JCASE®

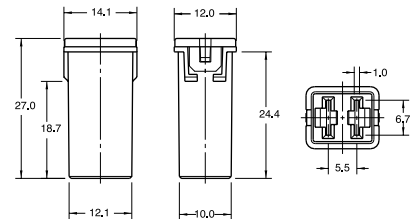

Low Profile JCASE® • 20-60A • Cartridge Fuses

Smaller space saving footprint is being designed in by many OEM's. Patented technology provides both increased time delay and low voltage drop. Features ANSI standard OCR-A font for visual inspection systems, double spring-beam box terminal and unique secondary locking feature holds terminal firmly in place. Additional information: littelfuse.com/LPJCASE

Voltage Rating: 58V DC, Interrupting Rating: 1000A @ 58V DC, Operating Temperature Range: -40°C to + 125°C, Insertion Force: 53N Max. (12 lb.), Extraction Force: 9N Min (2 lb.)

COLOR CODE	CURRENT RATING (A)	BOXED	CARDED
		MATERIAL NUMBER	PACKAGING MATERIAL NUMBER
Blue	20	LJCA020.X	LJCA020.XP
White	25	LJCA025.X	LJCA025.XPA
Pink	30	LJCA030.X	LJCA030.XP
Green	40	LJCA040.X	LJCA040.XP
Red	50	LJCA050.X	LJCA050.XP
Yellow	60	LJCA060.X	LJCA060.XP

Dimensions Low Profile JCASE®

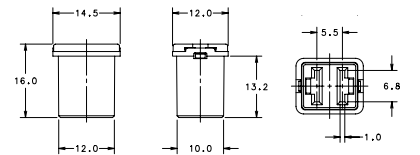

MCASE+™ • 15-60A • Cartridge Fuses

The Unslotted MCASE+™ Fuse is a cartridge style fuse up to 40A with female terminals for 2.8 mm male terminals. The Slotted MCASE+™ Fuse is available up to 60A and can mate with larger male 6.3mm terminals or mount directly to onto a busbar. Miniaturized footprint for optimal usage of space, featuring time delay and the ability to handle inrush currents.

Additional information: littelfuse.com/MCASE

Voltage Rating: 32V DC, Interrupting Ratings: 1000A @ 32V DC, Operating Temperature Range: -40°C to +125°C Fuse Insertion Force: 50N (11.2lbf) Typical, Extraction Force: 4N Min. (0.9 lb.) | 24.5N Max. (5.5 lb)

COLOR CODE	CURRENT RATING (A)	BULK 500 PC	BOXED 1 PC	CARDED
		MATERIAL NUMBER	MATERIAL NUMBER	MATERIAL NUMBER
Gray	15	0695015.U	MCAS015.X	MCAS015.XP
Blue	20	0695020.U	MCAS020.X	MCAS020.XP
White	25	0695025.U	MCAS025.X	MCAS025.XP
Pink	30	0695030.U	MCAS030.X	MCAS030.XP
Green	40	0695040.U	MCAS040.X	MCAS040.XP
Red	50	0695050.U	MCAS050.X	MCAS050.XP
Yellow	60	0695060.U	MCAS060.X	MCAS060.XP

Dimensions MCASE+™

UNSLOTTED

SLOTTED

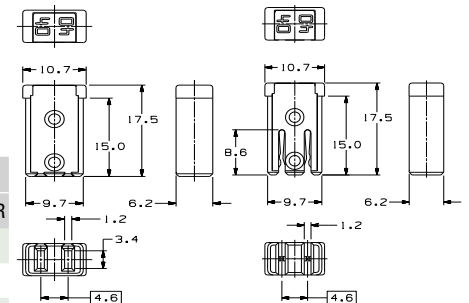

Bolt-Down Fuses

MEGA® • 80-500A • Bolt-Down Fuse



Littelfuse patented device designed for high current protection up to 500 amperes found on many OEM vehicles. Slo-Blo® feature eliminates nuisance blowing during temporary, short duration overloads. Commonly used for battery and alternator connections and other heavy gauge cables requiring ultra high current protection. Additional information: littelfuse.com/MEGA

Voltage Rating Characteristics: 32V AC/DC Slo-Blo®

CURRENT RATING (A)	BOXED 1PC	BOXED 50PC	CARDED
	MATERIAL NUMBER	MATERIAL NUMBER	PACKAGING MATERIAL NUMBER
80	OMEG080.X	—	OMEG080.XPA
100	OMEG100.X	OMEG100.L	OMEG100.XP
125	OMEG125.X	OMEG125.L	OMEG125.XP
150	OMEG150.X	OMEG150.L	OMEG150.XP
175	OMEG175.X	OMEG175.L	OMEG175.XP
200	OMEG200.X	OMEG200.L	OMEG200.XP
225	OMEG225.X	OMEG225.L	OMEG225.XP
250	OMEG250.X	OMEG250.L	OMEG250.XP
300	OMEG300.X	OMEG300.L	—
350	OMEG350.X	OMEG350.L	—
400	OMEG400.X	OMEG400.L	—
450	OMEG450.X	OMEG450.L	—
500	OMEG500.X	OMEG500.L	—

Dimensions

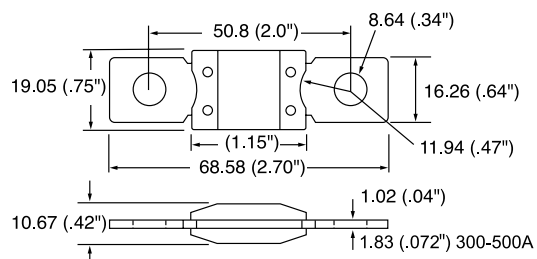

MIDI® • 20-200A • Bolt-Down Fuse

Littelfuse patented device found OEM on many OWM vehicles. Slo-Blo® feature eliminates nuisance blowing during temporary, short duration overloads.

Additional information: littelfuse.com/MIDI

Voltage Rating Characteristics: 32V AC/DC Slo-Blo®

CURRENT RATING (A)	BOXED		CARDED
	MATERIAL NUMBER	CATALOG NUMBER	MATERIAL NUMBER
50	OMID050.X	MID50	OMID050.XP
80	OMID080.X	MID80	OMID080.XP
150	—	—	OMID150.XP

Dimensions

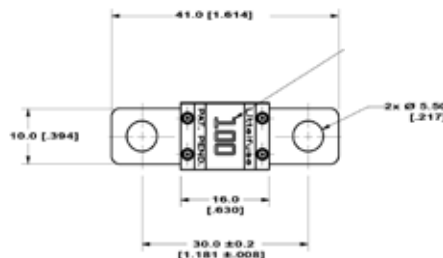

ZCASE • 125-250A • Bolt-Down Fuse

The Time Current characteristic is similar to the well known Mega Design and can be used as full wire protection until 250A. Higher ratings mostly used for typically Starter Fuse application as a protector fuse. The fuse design is optimized for a one bolt connection M6 (125A - 250 A) or M8 (300A - 600 A) and can be used directly on a battery post or busbar connection. Littelfuse is offering a complete solution for the necessary stud and different busbar connections including some battery clamps.

Additional information: littelfuse.com/ZCASE

CURRENT RATING (A)	BULK	CARDED
	MATERIAL NUMBER	MATERIAL NUMBER
125	3298125.Z	ZCAS125.XP
150	3298150.Z	ZCAS150.XP
175	3298175.Z	ZCAS175.XP
200	3298200.Z	ZCAS200.XP
225	3298225.Z	ZCAS225.XP
250	3298250.Z	ZCAS250.XP

Dimensions

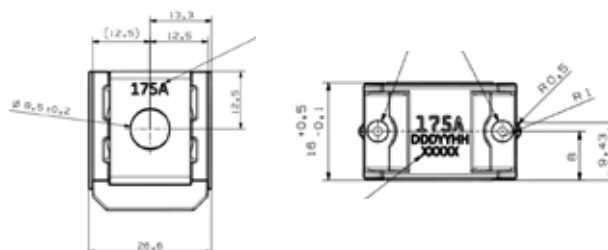

Auto Link Fuses

1



PAL Female Terminal

COLOR CODE	CURRENT RATING (A)	BOXED	CARDED
		MATERIAL NUMBER	PACKAGING MATERIAL NUMBER
Blue	20	OPAL020.X	OPAL020.XP
Pink	30	OPAL030.X	OPAL030.XP
Green	40	OPAL040.X	OPAL040.XP
Red	50	OPAL050.X	OPAL050.XP
Yellow	60	OPAL060.X	OPAL060.XP



PAL 9/16" Bent Male Terminal

COLOR CODE	CURRENT RATING (A)	BOXED	CARDED
		MATERIAL NUMBER	PACKAGING MATERIAL NUMBER
Pink	30	OPAL430.X	OPAL430.XP
Green	40	OPAL440.X	OPAL440.XP
Red	50	OPAL450.X	OPAL450.XP
Black	80	OPAL480.X	OPAL480.XP
Blue	100	OPAL4100X	OPAL4100XP
White	120	–	OPAL4120XP
Purple	140	–	OPAL4140XP



PAL Straight Male Terminal

COLOR CODE	CURRENT RATING (A)	BOXED	CARDED
		MATERIAL NUMBER	PACKAGING MATERIAL NUMBER
Pink	30	OPAL130.X	OPAL130.XP
Yellow	60	OPAL160.X	OPAL160.XP
Black	80	OPAL180.X	OPAL180.XP
Blue	100	OPAL1100X	OPAL1100XP
Gray	120	OPAL1120X	OPAL1120XP



PAL Locking Female Terminal

COLOR CODE	CURRENT RATING (A)	BOXED	CARDED
		MATERIAL NUMBER	PACKAGING MATERIAL NUMBER
Brown	25	OPAL525.X	OPAL525.XP
Green	30	OPAL530.X	OPAL530.XP



PAL 13/16" Bent Male Terminal

COLOR CODE	CURRENT RATING (A)	BOXED	CARDED
		MATERIAL NUMBER	PACKAGING MATERIAL NUMBER
Pink	30	OPAL230.X	OPAL230.XP
Green	40	OPAL240.X	OPAL240.XP
Red	50	OPAL250.X	OPAL250.XP
Yellow	60	OPAL260.X	OPAL260.XP
Brown	70	OPAL270.X	OPAL270.XP
Black	80	OPAL280.X	OPAL280.XP
Blue	100	OPAL2100X	OPAL2100XP
Gray	120	OPAL2120X	OPAL2120XP
Purple	140	–	OPAL2140XP



PAL Mini Female Terminal

COLOR CODE	CURRENT RATING (A)	BOXED	CARDED
		MATERIAL NUMBER	PACKAGING MATERIAL NUMBER
Pink	30A	OPAL330.X	OPAL330.XP
Green	40A	OPAL340.X	OPAL340.XP



Glass Fuses

AG • Glass Fuses

Originally stood for "all glass." The automotive industry uses the "AG" prefix (AGC, AGW) for most glass fuses. They vary in length, diameter and amperage rating.

Additional information: littelfuse.com/Glass

Voltage Rating: 32V AC/DC, 250V may be substituted

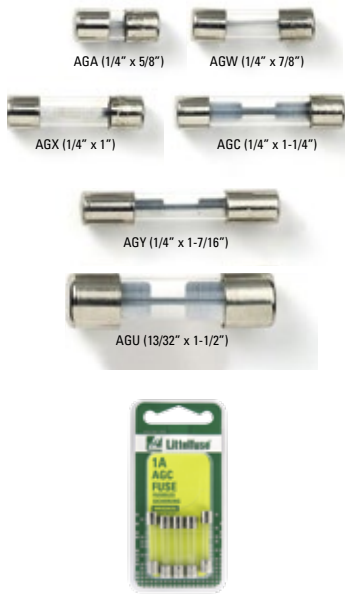

CURRENT RATING (A)	BOXED	CARDED
	MATERIAL NUMBER	PACKAGING MATERIAL NUMBER
AGA		
1	0AGA001.V	0AGA001.VP
2	0AGA002.V	0AGA002.VP
3	0AGA003.V	0AGA003.VP
5	0AGA005.V	0AGA005.VP
6	0AGA006.V	–
7.5	0AGA007.5V	–
10	0AGA010.V	0AGA010.VP
15	0AGA015.V	0AGA015.VP
20	0AGA020.V	0AGA020.VP
25	0AGA025.V	–
30	0AGA030.V	0AGA030.VP
AGW		
1	0AGW001.V	–
1.5	0AGW01.5V	–
2.5	0AGW02.5V	–
3	0AGW003.V	–
4	0AGW004.V	–
5	0AGW005.V	0AGW005.VP
6	0AGW006.V	–
15	0AGW015.V	0AGW015.VP
20	0AGW020.V	0AGW020.VP
30	0AGW030.V	0AGW030.VP

CURRENT RATING (A)	BOXED	CARDED
	MATERIAL NUMBER	PACKAGING MATERIAL NUMBER
AGC		
.5	0AGC.500V	–
1	0AGC001.V	0AGC001.VP
1.5	0AGC01.5V	0AGC01.5VP
2	0AGC002.V	0AGC002.VP
2.5	0AGC02.5V	0AGC2.5VP
3	0AGC003.V	0AGC003.VP
4	0AGC004.V	0AGC004.VP
5	0AGC005.V	0AGC005.VP
6	0AGC006.V	0AGC006.VP
7	0AGC007.V	–
7.5	0AGC07.5V	0AGC07.5VP
8	0AGC008.V	–
10	0AGC010.V	0AGC010.VP
15	0AGC015.V	0AGC015.VP
20	0AGC020.V	0AGC020.VP
25	0AGC025.V	0AGC025.VP
30	0AGC030.V	0AGC030.VP
35	0AGC035.V	0AGC035.VP

CURRENT RATING (A)	BOXED	CARDED
	MATERIAL NUMBER	PACKAGING MATERIAL NUMBER
AGU		
1	0AGU001.T	–
2	0AGU002.T	–
3	0AGU003.T	–
4	0AGU004.T	–
5	0AGU005.T	–
10	0AGU010.T	–
15	0AGU015.T	–
20	0AGU020.T	–
25	0AGU025.T	–
30	0AGU030.T	–
35	0AGU035.T	–
40	0AGU040.T	0AGU040.VPG
50	0AGU050.T	0AGU050.VPG
60	0AGU060.T	0AGU060.VPG
AGX		
2	0AGX002.V	–
3	0AGX003.V	–
20	0AGX020.V	0AGX020.VP
25	0AGX025.V	0AGX025.VP
30	0AGX030.V	0AGX030.VP

SFE • Glass Fuses

Glass fuses designed to specifications set by the Society of Fuse Engineers. All are 1/4 inch in diameter, but vary in length according to the ampere rating to ensure accurate fuse replacement.

Additional information: littelfuse.com/Glass

Voltage Rating: 32V AC/DC, 250V may be substituted



CURRENT RATING (A)	BOXED	CARDED
	MATERIAL NUMBER	PACKAGING MATERIAL NUMBER
4	0SFE004.V	0SFE004.VP
6	0SFE006.V	0SFE006.VP
7.5	0SFE007.5V	0SFE007.5VP
9	0SFE009.V	0SFE009.VP
14	0SFE014.V	0SFE014.VP
20	0SFE020.V	0SFE020.VP
30	0SFE030.V	0SFE030.VP

GBC • Torpedo Fuse

A thermoplastic type, torpedo shaped fuse that can be currently found in many European cars. Consisting of a heat resistant body, the fuse element stretches over the exterior of the body from end to end. The bodies vary in color (by amperage) to ensure proper replacement.

Additional information: littelfuse.com/Glass

Voltage Rating: 32V AC/DC, 250V may be substituted



CURRENT RATING (A)	BOXED	CARDED
	MATERIAL NUMBER	PACKAGING MATERIAL NUMBER
5	0GBC005.V	–
8	0GBC008.V	0GBC008.VP
16	0GBC016.V	0GBC016.VP
25	0GBC025.V	0GBC025.VP

Glass and Ceramic Fuses

1



A complete line of 3 AG 1" x 1-1/4" fuses designed for battery chargers, diagnostic equipment, appliances and sophisticated electronic equipment. Available bulk, boxed, and carded.

Additional information: littelfuse.com/Glass

Indicating 3AG Slo-Blo® • Glass Fuses

Littelfuse patented design Indicating fuse instantly shows whether fuse is blown through discoloration of the glass body. Reduces downtime by eliminating time consuming circuit testing and guesswork. This unique design offers the same characteristics as the standard 3AG Slo-Blo 313 fuse.

Approvals: UL listed: 1/2 – 8A, UL Recognized: 10A, CSA Certified: 1/2 – 8A.

VOLTAGE RATING	BOXED	DESCRIPTION
250V	313.500VID	1/2A Indicating 3AG Slo-Blo
250V	313001VID	1A Indicating 3AG Slo-Blo
250V	3131.50VID	1-1/2A Indicating 3AG Slo-Blo
250V	313002VID	2A Indicating 3AG Slo-Blo
250V	313003VID	3A Indicating 3AG Slo-Blo
250V	313004VID	4A Indicating 3AG Slo-Blo
250V	313005VID	5A Indicating 3AG Slo-Blo
250V	3136.25VID	6-1/4A Indicating 3AG Slo-Blo
250V	313007VID	7A Indicating 3AG Slo-Blo
250V	313008VID	8A Indicating 3AG Slo-Blo
32V	313010VID	10A Indicating 3AG Slo-Blo

Fast-Acting 3AG • Glass Fuses

Fast-acting protection of electronic equipment and appliances. The circuit protection standard for cost effective reliability and performance.

Approvals: UL listed: 1/2 – 8A, UL Recognized: 10A, CSA Certified: 1/2 – 8A.

VOLTAGE RATING	BOXED	DESCRIPTION
250V	312.250V	1/4A 3AG Fast-Acting
250V	312.500V	1/2A 3AG Fast-Acting
250V	312.750V	3/4A 3AG Fast-Acting
250V	312001V	1A 3AG Fast-Acting
250V	3121.25V	1-1/4A 3AG Fast-Acting
250V	31201.5V	1-1/2A 3AG Fast-Acting
250V	312002V	2A 3AG Fast-Acting
250V	31202.5V	2-1/2A 3AG Fast-Acting
250V	312003V	3A 3AG Fast-Acting
250V	312004V	4A 3AG Fast-Acting
250V	312005V	5A 3AG Fast-Acting
250V	312006V	6A 3AG Fast-Acting
250V	312007V	7A 3AG Fast-Acting
250V	312008V	8A 3AG Fast-Acting
250V	312010V	10A 3AG Fast-Acting

3AG Slo-Blo® • Glass Fuses

3AG (313) series Slo-Blo® fuses have a time delay in the overload range, which provides superior protection for inductive loads such as motors, transformers and solenoids.

Approvals: UL listed: 1/2 – 8A, UL Recognized: 10A – 30A, CSA, Certified: 1/2 – 8A.

VOLTAGE RATING	BOXED	DESCRIPTION	VOLTAGE RATING	BOXED	DESCRIPTION
250V	313.250V	1/4A 3AG Slo-Blo	250V	313003V	3A 3AG Slo-Blo
250V	313.500V	1/2A 3AG Slo-Blo	250V	313004V	4A 3AG Slo-Blo
250V	313.750V	3/4A 3AG Slo-Blo	250V	313005V	5A 3AG Slo-Blo
250V	313001V	1A 3AG Slo-Blo	250V	3136.25V	6-1/4A 3AG Slo-Blo
250V	31201.5V	1-1/2A 3AG Slo-Blo	250V	313008V	8A 3AG Slo-Blo
250V	313002V	2A 3AG Slo-Blo	32V	313010V	10A 3AG Slo-Blo
250V	31302.5V	2-1/2A 3AG Slo-Blo	32V	313015V	15A 3AG Slo-Blo

3AG Normal-Blo • Glass Fuses

3AG (311) series Normal-Blo fuses are for use in radios, amplifiers, etc. Features straight type fuse element positioned to center of fuse for easy identification of blown fuse.

VOLTAGE RATING	BOXED	DESCRIPTION
32V	311005V	5A 3AG Normal-Blo
32V	311010V	10A 3AG Normal-Blo
32V	311015V	15A 3AG Normal-Blo
32V	311025V	20A 3AG Normal-Blo

Fast-Acting 3AB Slo-Blo® • Ceramic Fuses

Ceramic body construction permits higher interrupting and voltage ratings. Ideal for applications where high current loads are expected.

Approvals: UL listed and CSA Certified: 1/8 – 15A, UL Recognized: 20 – 30A.

VOLTAGE RATING	BOXED	DESCRIPTION
250V	314010V	10A 3AB Fast-Acting
250V	314015V	15A 3AB Fast-Acting
250V	314020V	20A 3AB Fast-Acting
250V	326015V	15A 3AB Slo-Blo

8AG Normal-Blo • Glass Fuses

8AG (362) series Normal-Blo fuses are smaller in size (1/4" x 1") and are designed to be used where space limitations prevent the use of 3AG fuses. Approvals: UL listed: 1/8 – 5A, CSA Certified: 1/4 – 5A.

VOLTAGE RATING	BOXED	DESCRIPTION
32V	362002V	2A 8AG Normal-Blo
32V	362005V	5A 8AG Normal-Blo

Circuit Breakers

Type I • Automatic Reset

Cycles or continuously resets until the fault is corrected. Type I circuit breakers are typically used to protect circuits which occasionally experience momentary overloads such as wiper motor and headlamp circuits where a self resetting device is preferred.

Additional information: littelfuse.com/CircuitBreakers

Type II • Modified Reset

Non-cycling, remains in open position while there is power to the circuit. Resets when ignition is turned off. Type II circuit breakers are typically used in applications where fuse replacement is objectionable, such as power window, seat and sunroof circuits.

Type III • Manual Reset

Manually resettable circuit breakers remain in the open position until a button, lever or other external reset device is manually depressed. Type III circuit breakers are typically used in applications where a manual reset is desired for safe diagnosis of a circuit fault.



MINI® Circuit Breakers Standard Mini Footprint • Circuit Breakers

Designed to fit in a MINI® Blade fuse block or panel. SAE Type II used primarily as a wiring harness protector in 12V DC automotive systems. Conforms to SAE J553C standard.

CURRENT RATING (A)	BOXED
	MATERIAL NUMBER
5	0MIB005.X
10	0MIB010.X
15	0MIB015.X
20	0MIB020.X
25	0MIB025.X
30	0MIB030.X

Wide MINI® Footprint • Circuit Breakers

Direct factory replacement for many domestic OEM applications. Designed to fit either in an ATO® or NI® Blade fuse block or panel. Their blade configuration is of the MINI design and fit in a standard ATO style slot or across two MINI slots. Available in either SAE Type I cycling or SAE Type II non-cycling used primarily as a wiring harness protector in 12V DC automotive systems. Conforms to SAE J553C standard.

CURRENT RATING (A)	BOXED	APPLICATION	CYCLING	NON-CYCLING
	MATERIAL NUMBER			
15	0MMB015.X	Heavy Truck Headlamp	•	
20	0MMB020.X	Automotive Headlamp	•	
10	0MNB010.X	Heavy Duty Truck		•
15	0MNB015.X	Heavy Duty Truck		•
20	0MNB020.X	Automotive/Heavy Truck		•
25	0MNB025.X	Automotive/Heavy Truck		•
30	0MNB030.X	Automotive/Heavy Truck		•

Specialty OEM • Circuit Breakers

Direct factory replacement for many domestic OEM vehicles. SAE Type I and Type II modified reset used primarily as a wiring harness protector in 12V DC automotive systems. Conforms to SAE J553C standard. Designed to mount in ATO style fuse blocks and panels.



CURRENT RATING (A)	BOXED	CARDED	APPLICATION	OEM PART NUMBER
	MATERIAL NUMBER	MATERIAL NUMBER		
20	–	0ACB020.XP	Automotive Headlamp	GM# 12040816
30	–	0ACB030.XP	Power Windows, & Locks	GM# 01252240
20	0FCB020.X	0FCB020.XP	Power Windows	Ford# 83507005
25	0CCB025.X	0CCB025.XP	Windows, Seats & Locks	Ford# D9AB-14526-BA Chrysler# 4527053

Circuit Breakers

1



Universal Style • Circuit Breakers

Universal Circuit Breakers function identically and have same internal components as OEM breakers but offer the versatility of snap off terminals for greater flexibility. SAE Type II modified reset used primarily as a wiring harness protector in 12V DC automotive systems. Meets OEM requirements. Conforms to SAE J553C standard. Designed to mount in ATO style fuse blocks and panels.

CURRENT RATING (A)	BOXED	BOXED 100	BOXED BULK	CARDED
	MATERIAL NUMBER	MATERIAL NUMBER	MATERIAL NUMBER	PACKAGING MATERIAL NUMBER
5	OUCB005.X	BUCB005.H	BUCB005.Z	OUCB005.XP
6	–	–	–	OUCB006.XP
8	–	–	–	OUCB008.XP
10	OUCB010.X	BUCB010.H	BUCB010.Z	OUCB010.XP
15	OUCB015.X	BUCB015.H	BUCB015.Z	OUCB015.XP
20	OUCB020.X	BUCB020.H	BUCB020.Z	OUCB020.XP
25	OUCB025.X	BUCB025.H	BUCB025.Z	OUCB025.XP
30	OUCB030.X	BUCB030.H	BUCB030.Z	OUCB030.XP



MAXI Style • Circuit Breakers

Direct factory replacement for many domestic OEM applications. Designed to fit a MAXI Blade fuse block or panel. Available in either SAE Type I cycling or SAE Type II non-cycling. Used primarily as a wiring harness protector in 12V DC automotive systems. Meet OEM requirements. Conforms to SAE J553C standard.

CURRENT RATING (A)	BOXED	APPLICATION	OEM	CYCLING	NON-CYCLING
	MATERIAL NUMBER				
20	OMCB020.X	Automotive Headlamp	GM# 12065132	•	
30	OMCB030.X	Automotive Headlamp, Seats & Wipers	GM# 12088553	•	
40	OMCB040.X	–	–	•	
10	OMXB020.X	Automotive Power Devices Heavy Truck & Auto Cooling Fan	GM# 12077842 Ford# FGHT-14526-KA		•
15	OMXB020.X	Automotive Power Window Heavy Truck & Auto Cooling Fan & Power Window	GM# 12077843 Ford# F6HT-14526-LA		•



Fuse Clip • Circuit Breakers

Direct replacement for many OEM applications. Designed for glass fuses without physical alteration in the system. Fits 1-1/4" fuse clips. SAE Type II non-cycling used primarily as a wiring harness protector in 12V DC automotive systems. Conforms to SAE J553C standard.

CURRENT RATING (A)	BOXED	CARDED
	MATERIAL NUMBER	PACKAGING MATERIAL NUMBER
10	OCBF010.Z	OCBF010.XP
15	OCBF015.Z	OCBF015.XP
20	OCBF020.Z	OCBF020.XP
25	OCBF025.Z	OCBF025.XP
30	OCBF030.Z	OCBF030.XP
35	OCBF035.Z	OCBF035.XP
40	OCBF040.Z	OCBF040.XP

Circuit Breakers

50-150A • 32V DC • Hi-Amp Type III • Circuit Breakers



These high amp circuit breakers are typically used in auxiliary and accessory circuits for trucks, buses, RVs and marine applications in battery charger systems and DC audio systems. All high amp circuit breakers comply with the SAE J1117 and J1625 standard for ignition protection.

- Agency Approvals: UL Approved for all amp ratings at 32V DC
- Interrupting Rating: 3000A @30V DC
- Ignition Protection: SAE J1625 and J1171
- Material: Thermoset Plastic UL Rating 94VO
- Temperature Range: -32C to 92C
- RoHS Compliant.
- Waterproof

CURRENT RATING (A)	BOXED PART NUMBERS		CARDED PART NUMBERS		INTERRUPTING RATING	RoHS
	MATERIAL NUMBER	CATALOG NUMBER	MATERIAL NUMBER	CATALOG NUMBER		
50	0185050.X	185050	–	–	3000A @ 30 VDC	•
60	0185060.X	185060	–	–	3000A @ 30 VDC	•
70	0185070.X	185070	–	–	3000A @ 30 VDC	•
80	0185080.X	185080	–	–	3000A @ 30 VDC	•
100	0185100.X	185100	0185100.XP	185100BP	3000A @ 30 VDC	•
120	0185120.X	185120	0185120.XP	185120BP	3000A @ 30 VDC	•
150	–	–	0185150.XP	185150BP	3000A @ 30 VDC	•

Mini Type I • Circuit Breakers



Designed to fit in a MINI blade fuse block or panel. Conforms to SAE J553. Cycles or continuously resets until the fault is corrected. Type I circuit breakers are typically used to protect circuits which occasionally experience momentary overloads such as wiper motor and headlamp circuits where a self resetting device is preferred.

CURRENT RATING (A)	BOXED PART NUMBERS		CARDED PART NUMBERS	
	MATERIAL NUMBER	CATALOG NUMBER	MATERIAL NUMBER	CATALOG NUMBER
10	–	–	0211010.XP	211010BP
15	0211015.X	211015	0211015.XP	211015BP
20	0211020.X	211020	0211020.XP	211020BP
25	0211025.X	211025	0211025.XP	211025BP
30	0211030.X	211030	0211030.XP	211030BP

1

Box Style Circuit Breakers

Steel or plastic housing. Steel box type is approximately 1 1/4" x 3/4" x 2/3" and comes with integral brackets (to be directly affixed with screws or bolts) or without (needs a mounting bracket). Breakers have 10-32 studs, blades or wire leads. Wire lead type has a 10" wire loop connected to studs and PVC-coated. Loop is intended to be cut, stripped and spliced into a circuit.

Datasheet, wiring diagram, and additional pack sizes visit: littelfuse.com/CircuitBreakers



30056, 30137, 30171 - with studs, no bracket



30055, 30138, 30172 - with studs and bracket



300128 - with studs and cross-bracket



3088, 30507 - double breaker assembly

Steel Case With Stud Terminals

PART NUMBERS			VOLT (V DC)	AMPS (A)	SEALED	NOTES	
BULK	BOXED	RETAIL					
30056-8	-BX	-	12	8		Type I	
30056-10	-BX	-		10			
30056-15	-BX	-		15			
30056-20	-BX	-		20			
30056-25	-BX	-		25			
30056-30	-BX	-BP		30			
30056-40	-BX	-		40			
30056-50	-BX	-		50			
30137-6*	-	-		6	•		Type I sealed
30137-10*	-	-		10	•		
30137-15	-BX	-	15	•			
30137-20	-BX	-	20	•			
30137-30	-BX	-	30	•			

PART NUMBERS			VOLT (V DC)	AMPS (A)	SEALED	NOTES	
BULK	BOXED	RETAIL					
30055-8*	-	-	12	8		Type I with bracket	
30055-10	-BX	-		10			
30055-15	-BX	-BP		15			
30055-20	-BX	-BP		20			
30055-25	-BX	-		25			
30055-30	-BX	-BP		30			
30055-40	-BX	-BP		40			
30055-50	-BX	-BP		50			
30138-10*	-	-		10	•		Type I sealed with bracket
30138-15*	-	-		15	•		
30138-25*	-	-	25	•			
30138-30	-BX	-	30	•			
30138-40*	-	-	40	•			
30128-10	-BX	-	12	10	Type I with cross-bracket		
30128-15	-BX	-		15			
30128-20	-BX	-		20			
30128-30	-BX	-		30			
30128-40	-BX	-		40			

PART NUMBERS			VOLT (V DC)	AMPS (A)	SEALED	NOTES
BULK	BOXED	RETAIL				
30171-10	-BX	-	24	10		Type I
30171-15	-BX	-		15		
30171-20	-BX	-		20		
30171-30	-BX	-		30		
30172-10*	-	-	24	10		Type I with bracket
30172-15	-BX	-		15		
30172-20	-BX	-		20		
30172-30	-BX	-		30		
3088-50*	-	-	12	50		Type I double breaker assembly
3088-60	-BX	-		60		
3088-80	-BX	-		80		
30507-60	-BX	-		12	60	
30507-80	-BX	-	80		•	



30062 with wire leads, with bracket



30063 with wire leads, without bracket



30407 - Studs and cross-bracket



30401 - steel case with blades

Steel Case With Wire Terminals, PVC-Coated

PART NUMBERS			VOLT (V DC)	AMPS (A)	SEALED	NOTES
BULK	BOXED	RETAIL				
30062-20	-BX	-	12	20	•	Type I with Bracket
30062-30	-BX	-		30	•	
30063-10*	-	-	12	10	•	Type I
30063-20	-BX	-		10	•	
30063-30*	-	-		30	•	

Plastic Case, Stud Terminals

PART NUMBERS			VOLT (V DC)	AMPS (A)	SEALED	NOTES		
BULK	BOXED	RETAIL						
30407-15	-BX	-	12	15		Type III, Cross-Bracket		
30407-20	-BX	-		20				
30407-25*	-	-		25				
30407-30	-BX	-		30				
30407-40	-BX	-		40				
30414-30*	-	-		12	30		•	Type I, Cross Bracket
30414-50	-BX	-			50		•	

Steel Case With Blade Terminals

PART NUMBERS			VOLT (V DC)	AMPS (A)	SEALED	NOTES
BULK	BOXED	RETAIL				
30401-15	-BX	-	12	15		Type I
30401-20*	-	-		20		

*Special Order Item

Circuit Breakers



Stud Type Low Voltage (6–12 Volts) • Circuit Breakers

SAE Type I automatic reset provides protection in installations where it is not possible to manually reset a breaker because of location or safety requirements. Used primarily as a wiring harness protector in 12V DC automotive systems. Conforms to SAE J553C standard. Available with or without mounting bracket.

1

CURRENT RATING (A)	BOXED W/O BRACKET	BOXED W/ BRACKET	CARDED
	MATERIAL NUMBER	MATERIAL NUMBER	MATERIAL NUMBER
5	0812005.ZXST	0813005.ZXST	–
6	0812006.ZXST	0813006.ZXST	–
8	0812008.ZXST	0813008.ZXST	–
10	0812010.ZXST	0813010.ZXST	–
15	0812015.ZXST	0813015.ZXST	–
20	0812020.ZXST	0813020.ZXST	0813020.XP
25	0812025.ZXST	0813025.ZXST	–
30	0812030.ZXST	0813030.ZXST	0813030.XP
35	0812035.ZXST	0813035.ZXST	–
4	0812040.ZXST	0813040.ZXST	0813040.XP
50	0812050.ZXST	0813050.ZXST	0813050.XP

Circuit Breaker Accessories

Breaker mounting brackets & busbars. Mounting brackets available in steel or nylon and accept 30056 and 30137 series breakers.

Busbars are made from heavy solid brass or copper, with holes or slots that make it easy to connect box-type circuit breakers with studs, in order to feed a number of protected circuits.



30090-04 4-gang steel bracket



87128-4 Nylon bracket



86099-5 brass busbar with holes



86126-4 copper busbar with slots

PART NUMBERS		DESCRIPTION	NUMBER OF GANGS	MATERIAL	DIMENSIONS	MOUNTING HOLE DIMENSIONS	NOTES
BULK	BOXED						
30090-2	-BX	Mounting Bracket	2	Steel	.81" x 1.29" (122.2 x 32.8 mm)	4.00" (101.6mm) on centers	For all steel breakers without a bracket. Breakers snap into position, engaging with dimples in the case of the breaker.
30090-3	-BX		3		5.71" x 1.29" (145.0 x 32.8mm)	1.90" (124.5mm) on centers	
30090-4	-BX		4		6.62" x 1.29" (160.1 x 32.8mm)	5.81" (147.6mm) on centers	
30090-6	-BX		6		8.43" x 1.29" (214.1 x 32.8mm)	7.62" (193.5mm) on centers	
30090-8	-BX		8		10.25" x 1.29" (260.4 x 32.8mm)	9.43" (239.5mm) on centers	
87128-4	-BX	Mounting Bracket	4	Nylon	5.69" long (114.5mm)	4.89" (124.2mm) on centers	Secure stud-type breakers by tightening the nuts on the breaker studs. Slots: .910" (23.1mm) on centers, .210" (5.3mm) wide
87128-6	-BX		6		7.51" long (190.8mm)	6.71" (170.4mm) on centers	
87128-8	-BX		8		9.33" long (237.0mm)	8.53" (216.7mm) on centers	
87128-10	-BX		10		11.15" long (283.2mm)	10.35" (262.9mm) on centers	
87128-13	-BX		13		13.88" long (352.6mm)	13.08" (332.2mm) on centers	
86099-2	-BX	Busbar	2	Brass	1.53" long (38.9mm)	–	Holes: .910" (23.1mm) on centers, 0.21" (5.3mm) dia.
86099-3	-BX		3		2.43" long (61.7mm)	–	
86099-4	-BX		4		3.34" long (84.8mm)	–	
86099-5	-BX		5		4.24" long (107.7mm)	–	
86126-2	-BX	Busbar	2	Copper	1.41" x .560" (35.8 x 14.2mm)	.910" (23.11mm) on centers	Recommended for use with brackets 87128-X Slots: .910" on centers, .210" (5.3mm) wide
86126-4	-BX		4		3.23" x .560" (82.1 x 14.2mm)	2.73" (69.34mm) on centers	
86126-6	-BX		6		5.05" x .560" (128.3 x 14.2mm)	4.55" (115.57mm) on centers	
86126-8	-BX		8		6.87" x .560" (174.5 x 14.2mm)	6.37" (161.79mm) on centers	
86126-12	-BX		12		10.51" x .560" (267.0 x 14.2mm)	10.01" (254.25mm) on centers	

Assortment Kits

1

Commercial Assortments

Littelfuse Assortments cover all of the professional technician's circuit protection needs. Littelfuse offers the most comprehensive circuit protection kits on the market today addressing the needs of the Professional Service Center and Road Service Operation with genuine Littelfuse OEM fuses. Littelfuse Commercial Assortments are designed for the professional installer who needs a larger quantity and variety of fuses at the point of installation. Assortments are packaged in tough plastic storage containers perfect for the parts drawer, tool box, under counter or road service vehicle.

Additional information: littelfuse.com/KitAssortments



**ATO® Fuse
80 Piece Commercial Assortment**

CARDED	MATERIAL NUMBER	CATALOG NUMBER	CONTENT
	00940409Z	094409	(10) ATO 3 (10) ATO 5 (10) ATO 7.5 (10) ATO 10 (10) ATO 15 (10) ATO 20 (10) ATO 25 (10) ATO 30



**MICRO2™ Fuse
70 Piece Commercial Assortment**

CARDED	MATERIAL NUMBER	CATALOG NUMBER	CONTENT
	00940560ZXA	00940560	(10) MICRO2 5 (10) MICRO2 20 (10) MICRO2 7.5 (10) MICRO2 25 (10) MICRO2 10 (10) MICRO2 30 (10) LPMINI 15



**ATO® / MINI® Fuse
80 Piece Commercial Assortment**

CARDED	MATERIAL NUMBER	CATALOG NUMBER	CONTENT
	00940422Z	094422	(10) ATO 15 (10) ATO 20 (10) ATO 25 (10) ATO 30 (10) MINI 15 (10) MINI 20 (10) MINI 25 (10) MINI 30 (1) Puller



**MICRO2™, MICRO3™, MCASE® Fuse
135 Piece Commercial Assortment**

CARDED	MATERIAL NUMBER	CATALOG NUMBER	CONTENT
	00940570ZXA	00940570	(10) MICRO2, MICRO3 5 (10) MICRO 30 (10) MICRO2, MICRO3 7.5 (5) MCASE 15 (10) MICRO2, MICRO3 10 (5) MCASE 20 (10) MICRO2, MICRO3 15 (5) MCASE 25 (10) MICRO 20 (5) MCASE 30 (10) MICRO 25 (5) MCASE 40



**MINI® Fuse
80 Piece Commercial Assortment**

CARDED	MATERIAL NUMBER	CATALOG NUMBER	CONTENT
	00940551Z	094551	(10) MINI 3 (10) MINI 5 (10) MINI 7.5 (10) MINI 10 (10) MINI 15 (10) MINI 20 (10) MINI 25 (10) MINI 30



**MCASE® Fuse
80 Piece Commercial Assortment**

CARDED	MATERIAL NUMBER	CATALOG NUMBER	CONTENT
	00940565ZXA	00940565	(20) MCASE 20 (20) MCASE 25 (20) MCASE 30 (20) MCASE 40



**Low Profile MINI® Fuse
80 Piece Commercial Assortment**

CARDED	MATERIAL NUMBER	CATALOG NUMBER	CONTENT
	00940552Z	094552	(10) LPMINI 3 (10) LPMINI 5 (10) LPMINI 7.5 (10) LPMINI 10 (10) LPMINI 15 (10) LPMINI 20 (10) LPMINI 25 (10) LPMINI 30



**JCASE® Fuse
14 Piece Commercial Assortment**

CARDED	MATERIAL NUMBER	CATALOG NUMBER	CONTENT
	00940480Z	094480	(4) JCASE 20 (4) JCASE 30 (4) JCASE 40 (1) JCASE 50 (1) JCASE 60 (1) PULLER



**Low Profile JCASE® Fuse
16 Piece Commercial Assortment**

CARDED	MATERIAL NUMBER	CATALOG NUMBER	CONTENT
	00940553Z	094553	(4) LPJCASE 20 (4) LPJCASE 30 (4) LPJCASE 40 (1) LPJCASE 50 (1) LPJCASE 60 (1) PULLER



Assortment Kits

Smart Glow Commercial Assortments

SMART GLOW FUSE



It glows when it blows.



**Smart Glow ATO® Blade Fuse
80 Piece Commercial Assortment**



**Smart Glow MINI® Blade Fuse
80 Piece Commercial Assortment**



CARDED	PACKAGING MATERIAL NUMBER	CONTENT
	00940509ZXGLOA	(10) ATO 3 (10) ATO 5 (10) ATO 7.5 (10) ATO 10 (10) ATO 15 (10) ATO 20 (10) ATO 25 (10) ATO 30

CARDED	PACKAGING MATERIAL NUMBER	CONTENT
	00940510ZXGLOA	(10) ATO 3 (10) ATO 5 (10) ATO 7.5 (10) ATO 10 (10) ATO 15 (10) ATO 20 (10) ATO 25 (10) ATO 30

Caddys



Professional Fuse Caddy

Provides a complete assortment designed to meet the professional installer's on-the-road fuse needs. Contains 180 of the most popular fuses and installation tools (includes ATO®/MINI® Tester/ Puller) needed to service passenger cars and light trucks, heavy and medium trucks and buses.

Comes in compact handy storage box perfect for the on-the-road vehicle.

Additional information: littelfuse.com/KitAssortments

CARDED	MATERIAL NUMBER	CATALOG NUMBER	CONTENT
	00940396Z	094396	(5) ATO 3 (5) ATO 5 (5) ATO 7.5 (10) ATO 10 (15) ATO 15 (15) ATO 20 (10) ATO 25 (15) ATO 30 (5) MIN 2 (5) MIN 3 (5) MIN 4 (5) MIN 5 (5) MIN 7.5 (5) MIN 10 (5) MIN 15 (5) MIN 20 (5) MIN 25 (5) MIN 30 (5) AGC 5 (5) AGC 10 (5) AGC 15 (5) AGC 20 (5) AGC 25 (5) AGC 30 (5) SFE 14 (5) SFE20 (5) SFE 30 (1) MAX 20 (1) MAX 30 (1) MAX 40 (1) MAX 50 (1) MAX 60 (1) Fuse Tester and Puller (1) Tri-puller™ (1) MAXI Fuse Puller

Assortment Kits

1



Red Box

Designed by Littelfuse®, it features the exact OEM parts used for the glass, ATO®, MINI®, MAXI, PAL, JCase®, low profile MINI®, MCase, MICRO2 and MICRO3 fuses installed on over 98% of the cars, vans, light trucks and SUV's on the road today. All come packed inside one compact, portable, organized carrying case. With Red Box™, your days of wasting valuable shelf space on redundant part numbers is over. Over 500 fuses inside Red Box™ meet over 98% of the market's circuit protection needs, giving you more coverage and more profit with a lot less inventory.

Additional information: littelfuse.com/RedBox

KIT Professional Installer Case

MATERIAL NUMBER	CATALOG NUMBER
0RED0BOXZ	REDBOX

KIT Professional Installer Case (no Glass with Module 5)

MATERIAL NUMBER	CATALOG NUMBER
0RED0BOXZXNG	REDBOXNG

KIT Professional Installer Case (no Glass with Module 6)

MATERIAL NUMBER
0RED0BOXZXNGA

Glass Module (Module 5)

MATERIAL NUMBER	CATALOG NUMBER	
0RBOX005Z	RBOX5	
0AGC001.V	AGC GLASS BOX 1A	10
0AGC002.V	AGC GLASS BOX 2A	10
0AGC003.V	AGC GLASS BOX 3A	10
0AGC004.V	AGC GLASS BOX 4A	10
0AGC005.V	AGC GLASS BOX 5A	10
0AGC006.V	AGC GLASS BOX 6A	10
0AGC007.5V	AGC GLASS BOX 7.5A	10
0AGC010.V	AGC GLASS BOX 10A	10
0AGC015.V	AGC GLASS BOX 15A	10
0AGC020.V	AGC GLASS BOX 20A	10
0AGC025.V	AGC GLASS BOX 25A	10
0AGC030.V	AGC GLASS BOX 30A	10
0AGW030.V	AGW GLASS BOX 30A	10
0AGX030.V	AGX GLASS BOX 30A	10
0SFE004.V	SFE GLASS BOX 4A	10
0SFE009.V	SFE GLASS BOX 9A	10
0SFE014.V	SFE GLASS BOX 14A	10
0SFE020.V	SFE GLASS BOX 20A	10
0SFE030.V	SFE GLASS BOX 30A	10
	Puller Tester	1

Low Profile MINI® Module (Module 1)

MATERIAL NUMBER	CATALOG NUMBER	
0RBOX001Z	RBOX1	
LMIN005.V	5A LOW PROFILE MINI FUSE	5
LMIN07.5V	7.5A LOW PROFILE MINI FUSE	10
LMIN10.V	10A LOW PROFILE MINI FUSE	10
LMIN15.V	15A LOW PROFILE MINI FUSE	10
LMIN20.V	20A LOW PROFILE MINI FUSE	5
LMIN25.V	25A LOW PROFILE MINI FUSE	5
LMIN30.V	30A LOW PROFILE MINI FUSE	10
00970038Z	ATO/MINI PULLER (WHITE)	1

JCASE® Module (Module 2)

MATERIAL NUMBER	CATALOG NUMBER	
0RBOX002Z	0RBOX002ZX A RBOX2	
JCAS020.V	JCASE 32V S/B BOX 20A	2
JCAS030.V	JCASE 32V S/B BOX 30A	2
JCAS040.V	JCASE 32V S/B BOX 40A	2
JCAS050.V	JCASE 32V S/B BOX 50A	2
JCAS060.V	JCASE 32V S/B BOX 60A	2
00970053Z	JCASE PULLER	1

Blade Fuse Module (Module 3)

MATERIAL NUMBER	CATALOG NUMBER	
0RBOX003Z	RBOX3	
0ATO005.V	ATO BLADE FUSE BOX 5A	10
0ATO07.5V	ATO BLADE FUSE BOX 7.5A	10
0ATO010.V	ATO BLADE FUSE BOX 10A	25
0ATO015.V	ATO BLADE FUSE BOX 15A	25
0ATO020.V	ATO BLADE FUSE BOX 20A	25
0ATO025.V	ATO BLADE FUSE BOX 25A	25
0ATO030.V	ATO BLADE FUSE BOX 30A	25
0ATO040.V	ATO BLADE FUSE BOX 40A	10
0MIN005.V	MINI BLADE FUSE BOX 5A	10
0MIN07.5V	MINI BLADE FUSE BOX 7.5A	10
0MIN10.V	MINI BLADE FUSE BOX 10A	20
0MIN15.V	MINI BLADE FUSE BOX 15A	20
0MIN20.V	MINI BLADE FUSE BOX 20A	20
0MIN25.V	MINI BLADE FUSE BOX 25A	10
0MIN30.V	MINI BLADE FUSE BOX 30A	10
0MAX020.V	MAXI BLADE BOX 20A	2
0MAX030.V	MAXI BLADE BOX 30A	2
0MAX040.V	MAXI BLADE BOX 40A	2
0MAX050.V	MAXI BLADE BOX 50A	2
0MAX060.V	MAXI BLADE BOX 60A	2
0MAX070.V	MAXI BLADE BOX 70A	1
0MAX080.V	MAXI BLADE BOX 80A	1
00970019X	FUSE TESTER AND PULLER BOX	1
00970038Z	ATO/MINI PULLER (WHITE)	1
00970026N	MAXI FUSE PULLER BOX	1
FHAC0002Z	ATO HD INLINE FUSE HOLDER BOX	1
0FHM0002Z	MINI HD INLINE FUSE HOLDER BOX	1

PAL Module (Module 4)

MATERIAL NUMBER	CATALOG NUMBER	
0RBOX004Z	RBOX4	
0PAL020.X	FEMALE TERM BOX 20A	1
0PAL030.X	FEMALE TERM BOX 30A	1
0PAL040.X	FEMALE TERM BOX 40A	1
0PAL050.X	FEMALE TERM BOX 50A	1
0PAL060.X	FEMALE TERM BOX 60A	1
0PAL130.X	STRAIGHT MALE TERM BOX 30A	1
0PAL160.X	STRAIGHT MALE TERM BOX 60A	1
0PAL180.X	STRAIGHT MALE TERM BOX 80A	1
0PAL1100.X	STRAIGHT MALE TERM BOX 100A	1
0PAL1120.X	STRAIGHT MALE TERM BOX 120A	1
0PAL230.X	13/16" BENT MALE TERM BOX 30A	1
0PAL240.X	13/16" BENT MALE TERM BOX 40A	1
0PAL250.X	13/16" BENT MALE TERM BOX 50A	1
0PAL260.X	13/16" BENT MALE TERM BOX 60A	1
0PAL270.X	13/16" BENT MALE TERM BOX 70A	1
0PAL280.X	13/16" BENT MALE TERM BOX 80A	1
0PAL2100.X	13/16" BENT MALE TERM BOX 100A	1
0PAL2120.X	13/16" BENT MALE TERM BOX 120A	1
0PAL330.X	MINI FEMALE TERM BOX 30A	1
0PAL340.X	MINI FEMALE TERM BOX 40A	1
0PAL430.X	9/16" BENT MALE TERM BOX 30A	1
0PAL440.X	9/16" BENT MALE TERM BOX 40A	1
0PAL450.X	9/16" BENT MALE TERM BOX 50A	1
0PAL480.X	9/16" BENT MALE TERM BOX 80A	1
0PAL4100.X	9/16" BENT MALE TERM BOX 100A	1
0PAL525.X	LOCKING FEMALE TERM BOX 25A	1
0PAL530.X	LOCKING FEMALE TERM BOX 30A	1

MICRO2, MICRO3, MCase®, LPJCASE® Module (Module 6)

MATERIAL NUMBER	CATALOG NUMBER	
0RBOX006Z	RBOX6	
MIC2005.V	MICRO2 Fuse 5A	10
MIC207.5V	MICRO2 Fuse 7.5A	10
MIC2010.V	MICRO2 Fuse 10A	10
MIC2015.V	MICRO2 Fuse 15A	10
MIC2020.V	MICRO2 Fuse 20A	10
MIC2025.V	MICRO2 Fuse 25A	10
MIC3005.V	MICRO3 Fuse 5A	10
MIC307.5V	MICRO3 Fuse 7.5A	10
MIC3010.V	MICRO3 Fuse 10A	10
MCAS020.V	MCase Fuse 20A	10
MCAS025.V	MCase Fuse 25A	10
MCAS030.V	MCase Fuse 30A	10
MCAS040.V	MCase Fuse 40A	10
LJCA020.V	LOW PROFILE JCASE 20A	10
LJCA025.V	LOW PROFILE JCASE 25A	10
LJCA030.V	LOW PROFILE JCASE 30A	10
LJCA040.V	LOW PROFILE JCASE 40A	10
LJCA050.V	LOW PROFILE JCASE 50A	10
LJCA060.V	LOW PROFILE JCASE 60A	10

Assortment Kits

Modular Rack Systems

The new MRS Modular Rack System is a flexible offering of fuses that can be ordered based on your needs. Each rack is sold individually and can be locked together to sit on a counter, or wall mounted. They are also available as a complete kit. Size charts, and color identification charts are included to serve as a guide for easy identification and replacement.



MATERIAL NUMBER	CATALOG NUMBER	DESCRIPTION	CONTENTS
OMRS0001Z	MRS1	ATO® Modular Rack System	See Table Below
OMRS0002Z	MRS2	MINI®-Maxi Modular Rack System	See Table Below
OMRS0003Z	MRS3	Glass Modular Rack System	See Table Below
OMRS0003ZXE	MRS3E	Empty Glass Modular Rack System	Empty
OMRS0004Z	MRS4	PAL-Mega Modular Rack System	See Table Below
OMRS0005Z	MRS5	PAL-JCASE® Modular Rack System	See Table Below
OMRS0006Z	MRS6	ATO®-MINI® Modular Rack System	See Table Below
OMRS0007Z	MRS7	Modular Rack System Complete	MRS 1, 2, 3, 4, 5 & 6 - See Table Below
OMRS0009ZXA	MRS9	ACS Micro2/Micro3/MCase Modular Rack System	See Table Below
OMRS0200Z	MRS200	ATO®-MINI®-Maxi Modular Rack System	MRS Racks 1 & 2 (Assembled)
OMRS0200ZXE	MRS200E	EMPTY ATO®-MINI®-Maxi Modular Rack System	MRS Rack with ATO®-MINI®-Maxi graphics (only)
OMRS0200ZXMA	MRS200MA	Marine Fuse Modular Rack System	MRS Rack with ATO®-MINI®-Maxi -Glass graphics (only)
OMRS0300Z	MRS300	ATO®-MINI®-Maxi-Glass Modular Rack System	MRS Racks 1, 2 & 3 (Assembled)
OMRS0300ZXE	MRS300E	EMPTY ATO®-MINI®-Maxi-Glass Modular Rack System	Empty MRS Rack with "Glass" header (only)

Modular Rack Systems Part Number Contents

MATERIAL NUMBER	OMRS0001ZXA	OMRS0002ZXA	OMRS0003ZXA		OMRS0004ZXA	OMRS0005ZXA		OMRS0006ZXA	OMRS0009ZXA	
FUSE TYPE	ATO	MINI/MAXI	GLASS/CERAMIC		PAL/MEGA	PAL/JCASE		ATO/MINI ASST'S	MICRO2/MICRO3/MCASE	
CONTENTS	(5) ATO1	(5) MIN2	(5) AGC1	(10) SFE4	(2) PAL20	(1) PAL1120	(1) PAL430	(12) 094202B	MIC2 5	MIC3 10
	(5) ATO2	(5) MIN3	(5) AGC2	(10) SFE7.5	(4) PAL30	(1) PAL230	(1) PAL440	(12) 094362B	MIC2 7.5	MIC3 15
	(5) ATO3	(5) MIN4	(10) AGC3	(10) SFE9	(3) PAL40	(1) PAL240	(1) PAL450		MIC2 10	MCAS 15
	(5) ATO4	(10) MIN5	(5) AGC5	(10) SFE14	(3) PAL50	(1) PAL250	(1) PAL480		MIC2 15	MCAS 20
	(10) ATO5	(10) MIN7.5	(5) AGC7.5	(30) SFE20	(2) PAL60	(1) PAL260	(1) PAL4100		MIC2 20	MCAS 25
	(10) ATO7.5	(15) MIN10	(10) AGC10	(10) SFE30	(1) PAL130	(1) PAL270	(1) PAL525		MIC2 25	MCAS 30
	(15) ATO10	(20) MIN15	(20) AGC15	(10) GBC8	(2) PAL160	(1) PAL280	(1) PAL530		MIC2 30A	MCAS 40
	(15) ATO15	(20) MIN20	(20) AGC20	(10) GBC16	(3) PAL180	(1) PAL2100	(1) JCAS40		MIC3 5	
	(20) ATO20	(15) MIN25	(10) AGC25	(10) GBC25	(2) PAL1100	(1) PAL2120	(1) JCAS50		MIC3 7.5	
	(10) ATO25	(15) MIN30	(30) AGC30		(2) MEG 175	(1) JCAS20	(1) JCAS60			
	(15) ATO30	(2) MAX20	(5) AGW15			(2) JCAS30				
	(5) ATO40	(3) MAX30	(5) AGW20			(1) PAL330				
	(2) MAX40				(1) PAL340					
	(2) MAX50									
	(3) MAX60									

Assortment Kits

Value Pack Kits

The Littelfuse Value Packs contain a complete assortment of OEM fuses. Value Packs give you the tools for the protection you need — when and where you need it! The Ultimate fuse kit for home and shop comes in a clear plastic, reusable package.

MATERIAL NUMBER	CATALOG NUMBER	DESCRIPTION
00940400Z	094400	ATO® Super Value Pack 40pc
00940462Z	094462	MINI® Super Value Pack 40pc
00940475Z	094475	ATO®, MINI®, MAXI Super Value Pack 21pc
00940550Z	094550	MINI®/JCASE® Super Value Pack 29pc
00940554Z	—	Low Profile MINI® / Low Profile JCASE® Super Value Pack 30pc
00940557ZXA	—	AGC Glass Super Value Pack 40pc
00940566ZXA	—	Micro2/Micro3 Super Value Pack 60pc



Fuse Assortment Kits

Littelfuse assortments contain a variety of a type of fuse for your specific needs.

MATERIAL NUMBER	CATALOG NUMBER	DESCRIPTION	CONTENTS
00940133ZP	94133	European Fuse Assortment	2 each: GBC 8A, 16A Fuses & 1 each: GBC 25 A
00940134ZP	94134	British Fuse Assortment	1 each: AGC 7.5A, 15A, 20A (SFE 20) 1 each: 03000128M Amp Fuses
00940135ZP	94135	Japanese Fuse Assortment	1 each: AGC 5A, 10A, 15A, 20A (SFE 20), 30A Fuses
00940154ZP	94154	American Fuse Assortment	1 each: AGC 10A, 15A, 30A & 1 each: SFE 9A, 14A, 20A Fuses
00940189ZP	94189	Cellular Fuse Assortment	1 each: AGC 1.5A, 3A Fuses & 3 each: AGC 2A Fuses
00940202ZP	94202	ATO Fuse Assortment 6pc	1 each: ATO 5A, 10A, 15A, 20A, 25A, 30A Fuses
00940301ZP	94301	Japanese ATO Fuse Assortment	1 each: ATO 5A, 7.5A, 10A, 15A, 20A Fuses
00940362ZP	94362	Mini Fuse Assortment	1 each: MINI 3A, 5A, 7.5A, 10A, 15A, 20A, 25A, 30A
00940408ZP	94408	Computer Fuse Assortment	1 each: AGC .5A Fuses & 2 each: AGC 1A, 2A Fuses
00940412ZP	94412	Electric Fence Assortment	5 each: AGC 1A Fuses
00940416Z	94416	ATO Fuse Assortment (boxed only)	1 each: ATO 10A, 15A, 20A, 25A, 30A Fuses
00940500Z	94500	Mini Fuse Assortment (boxed only)	1 each: MINI 10A, 15A, 20A, 25A, 30A Fuses
00940506ZP	94506	Low Profile Mini Fuse Assortment	1 each: LMIN 7.5A, 10A, 15A, 20A, 25A, 30A Fuses
00940558ZPA	—	Micro2 Fuse Assortment	1 each: Micro2 5A, 10A, 15A, 20A, 25A Fuses
00940559ZPA	—	MCase Fuse Assortment	1 each: 15A, 20A, 25A, 30A, 40A Fuses
0AGA0001ZP	AGA1ZP	AGA Glass Fuse Assortment	1 each: AGA 1A, 2A, 3A, 5A, 7.5A, 10A, 15A, 20A, 25A, 30A Fuses
0AGC0001ZP	AGC1ZP	AGC Glass Fuse Assortment	1 each: AGC 1A, 2A, 2.5A, 3A, 4A, 5A, 6A, 7.5A, 8A, 10A, 15A, 20A, 25A, 30A, 35A Fuses
0AGW0001ZP	AGW1ZP	AGW/AGX Glass Fuse Assortment	1 each: AGW 3A, 4A, 5A, 15A, 20A, 30A Fuses 1 each: AGX 3A, 20A, 25A, 30A Fuses
0SFE0001ZP	SFE1ZP	SFE Glass Fuse Assortment	1 each: SFE 4A, 6A, 7.5A, 9A Fuses & 2 each: 14A, 20A, 30A Fuses



Smart Glow

MATERIAL NUMBER	CATALOG NUMBER	DESCRIPTION	CONTENTS
00940202ZPGLO	10-1008	ATO SmartGlow Assortment 5 PK	1 each: ATO 10A, 15A, 20A, 25A, 30A Fuses
00940362ZPGLO	11-1008	Mini SmartGlow Assortment 5 PK	1 each: MINI 10A, 15A, 20A, 25A, 30A Fuses
00940400ZGLO	14-0000	ATO SmartGlow Assortment 42 PK	7 each: ATO GLO 5A, 10A, 15A, 20A, 25A, 30A Fuses
00940462ZGLO	15-0000	Mini SmartGlow Assortment 36 PK	6 each: MINI GLO 5A, 10A, 15A, 20A, 25A, 30A Fuses
00940555ZPGLO	—	ATO SmartGlow Assortment 5 PK w/ Flashlight	1 each: ATO GLO 10A, 15A, 20A, 25A, 30A Fuses & (1) MINI Keychain LED Flashlight
00940556ZPDSGLO	094556DSGLO	Mini SmartGlow Assortment 5 PK Display Strip	1 each: Perforated Display Strip, S Hook 1 each: MINI GLO 10A, 15A, 20A, 25A, 30A Fuses & (1) MINI Keychain LED Flashlight
00940556ZPGLO	094556	Mini SmartGlow Assortment 5 PK w/ Flashlight	1 each: MINI GLO 10A, 15A, 20A, 25A, 30A Fuses & (1) MINI Keychain LED Flashlight
0AGC0001ZPGLO	16-1008	AGC Glass Assortment 5 PK	1 each: AGC 5A, 10A, 15A, 20A, 30A Fuses
0SFE0001ZPGLO	—	SFE Glass SmartGlow Fuse Assortment 5 PK	1 each: SFE 7.5A, 9A, 14A & 2 each: 20A Fuses

SMART GLOW
Fuse

Assortment Kits

Emergency Kits

Available in OEM ATO® and MINI® fuse versions. The Littelfuse Emergency Diagnostic Fuse Kits are ideal for the glove box or trunk offering instant protection in the garage or on the road. Packaging designed to generate impulse sales. Contains the most popular amperages.

Includes roadside tester/puller that tests, removes and installs fuses. Has its own power source that allows it to operate with or without voltage to a maximum of 24V DC.

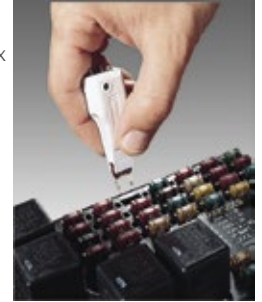

1

MATERIAL NUMBER	CATALOG NUMBER	DESCRIPTION	CONTENTS
00940363ZP	094363	MINI® Emergency Fuse Kit	1 each: MINI 3A, 5A, 7.5A, 10A, 15A, 20A, 25A, 30A Fuses (1) Puller
00940365ZP	094365	Motorcycle Glass Emergency Kit	1 each: AGX 5A, 10A, 15A, 20A Fuses 2 each: AGX 8A Fuses (1) Puller
00940366ZP	094366	Motorcycle ATO® Emergency Kit	1 each: ATO 5A, 7.5A, 10A, 15A, 20A Fuses (1) Puller
00940367ZP	094367	American Glass Emergency Kit	1 each: SFE 9A, 14A, 20A 1 each: AGC 5A, 15A, 30A Fuses (1) Puller
00940368ZP	094368	European GBC Emergency Kit	1 each: GBC 5A, 16A, 25A Fuses 2 each: GBC 8A Fuses (1) Puller
00940369ZP	094369	Japanese Glass Emergency Kit	1 each: AGC 5A, 10A, 15A, 20A, 30A Fuses (1) Puller
00940370ZP	094370	ATO® Emergency Kit	1 each: ATO 5A, 10A, 15A, 20A, 25A, 30A Fuses (1) Puller
00940418ZP	094418	ATO® Emergency Diagnostic Kit	1 each: ATO 5A, 10A, 15A, 20A, 25A, 30A Fuses (1) ATO Puller
00940419ZP	094419	Glass Emergency Fuse Kit	1 each: AGC 7.5, 15A, 20A, 25A, 30A (1) Glass Puller
00940461ZP	094461	MINI® Emergency Diagnostic Kit	1 each: MINI 3A, 4A, 7.5A, 10A, 15A, 20A, 25A, 30A Fuses (1) ATO/MINI Tester/Puller
00940479ZP	094479	ATO®/MINI® Emergency Diagnostic Kit	1 each: ATO 5A, 10A, 15A, 20A, 25A, 30A 1 each: MINI 3A, 5A, 7.5A, 10A, 15A, 20A, 25A, 30A Fuses (1) Puller
		LMIN Emergency Fuse Kit	
		MCase, Micro2, Micro3 Emergency Kit	
00940561ZPA	–	OEM Emergency Kit - GM	1 each: MINI 7.5A, 25A, 30A 1 each: LP MINI 10A, 15A 1 each: JCASE 20A, 30A, 40A, 50A 1 each: LPJCASE 30A, 40A, 2 each: MINI 20A 3 each: MINI 10A, 15A
00940562ZPA	–	OEM Emergency Kit - Ford	1 each: MINI 7.5A, 25A, 30A 1 each: LP MINI 10A, 15A 1 each: JCASE 20A, 30A, 40A, 50A 1 each: LPJCASE 30A, 40A, 2 each: MINI 20A 3 each: MINI 10A, 15A
00940563ZPA	–	OEM Emergency Kit - Chrysler/Dodge/Jeep	1 each: MINI 7.5A, 25A, 30A 1 each: JCASE 20A, 30A, 40A, 50A 2 each: MINI 20A 3 each: MINI 10A, 15A



Specialty Fuse Products

1



CNN and CNL Fuses • Forklift Type

CNL fast-acting and CNN very fast-acting fuses are recommended for use on battery operated lift trucks and other low voltage battery operated equipment. Part No. example: CNN 700.

- Voltage Rating: CNL: 32V DC
CNN: 48V DC, 75V AC
- Interrupting Rating: 2,500 amperes
- Ampere Range: 10-800 degrees
- Maximum Torque: 90 lbs.

Download additional technical information at: littelfuse.com/CNN

PART NUMBER		PART NUMBER	
MATERIAL NUMBER	CATALOG NUMBER	MATERIAL NUMBER	CATALOG NUMBER
OCNL035.V	CNL035	OCNN010.V	CNN010
OCNL040.V	CNL040	OCNN035.V	CNN035
OCNL050.V	CNL050	OCNN040.V	CNN040
OCNL060.V	CNL060	OCNN050.V	CNN050
OCNL080.V	CNL080	OCNN060.V	CNN060
OCNL100.V	CNL100	OCNN080.V	CNN080
OCNL125.V	CNL125	OCNN090.V	CNN090
OCNL150.V	CNL150	OCNN100.V	CNN100
OCNL175.V	CNL175	OCNN125.V	CNN125
OCNL200.V	CNL200	OCNN150.V	CNN150
OCNL250.V	CNL250	OCNN175.V	CNN175
OCNL275.V	CNL275	OCNN200.V	CNN200
OCNL300.V	CNL300	OCNN225.V	CNN225
OCNL325.V	CNL325	OCNN250.V	CNN250
OCNL350.V	CNL350	OCNN275.V	CNN275
OCNL400.V	CNL400	OCNN300.V	CNN300
OCNL500.V	CNL500	OCNN325.V	CNN325
-	-	OCNN350.V	CNN350
-	-	OCNN400.V	CNN400
-	-	OCNN500.V	CNN500
-	-	OCNN600.V	CNN600
-	-	OCNN700.V	CNN700
-	-	OCNN800.V	CNN800

Honda and Universal Fusible Links



Original equipment replacement fusible link bar for Honda Civics. Available in 45, 55 and 65 amp fuse bars. Carded merchandise only available in 3 piece assortment 094413.



Universal fusible links are original equipment replacement fusible link bar. Available in 30, 50, 80 and 100 amp fuse bars.



CARDED PART NUMBER		DESCRIPTION
MATERIAL NUMBER	CATALOG NUMBER	
00940413ZP	094413	ASST Honda Fusible Link Assortment
OFLC014.XP	FLC14BP	Fusible Link 14 AWG
OFLW014.XP	FLW14BP	Fusible Link 14 AWG with Terminals
OFLW016.XP	FLW16BP	Fusible Link 16 AWG with Terminals
00940402ZP		ASST Volkswagen Fusible Link Assortment

Power Distribution Modules

Power Distribution Modules (PDMs) are devices that accept electrical power from one or more wires (inputs) and then distribute it to multiple cables (outputs). The PDMs also accept power protection and control devices from one or more fuse, circuit breaker, relay, diode, or even solid state and electronic circuitry and distribute to multiple outputs.

Blade or Bolt-Down Fuse?

DC (automotive) fuses are offered in two basic forms: Bladed or Bolt Down.

Blade – can be hand inserted into a fuse holder. These fuses provide protection for several amperage ratings up to 70A. They are well suited to protect smaller to medium diameter wires that are usually some distance from the battery. Single blade fuse holders are often called 'In-Line' fuse holders as they are spliced into the wiring. Remember to place the fuse holder as close to the battery and as far away from the load as possible. Littelfuse blade fuses include: Micro 2, Micro 3, mini, LP mini, ATO, Maxi, mCase, mCase +, J Case and LP JCase. We offer fuse holders for many of these fuses.

Bolt Down – need to be secured to the fuse holder with a screw or nut/bolt. These fuses provide protection from 30A to 500A. They are well suited to protect medium to large diameter wires that are usually closer to the battery. Ring terminals are crimped onto cables that are connected to these holders and spliced into the wiring. Remember to place the fuse holder as close to the battery and as far away from the load as possible. Littelfuse bolt-down fuses include: MIDI, MEGA, CF8 and Z-Case. We offer fuse holders for many of these fuses.

Also there are still a wide variety of applications that use glass tube fuses. These are typically lower current values and are becoming less popular for most automotive applications due to their size, form factors, and lack of color coding.



Hard-Wired Boxes



HWB60-AL



HWB60

HWB Series - Compact Sealed Hard-Wired Boxes for 2.8mm Style Fuses & Relays

HWB series hard-wired boxes are sealed units that accept any 2.8mm style fuses, relays, circuit breakers or diodes depending on which HWB model is selected. The HWB series is the perfect fit for accessory circuits and overflow circuits from your main power distribution module.

The series features durable construction, IP67 & IP69K ratings, compact sizes gasket sealed covers and multiple mount types. See chart below for specific details. The HWB series eliminates the use of internal bussing allowing the user or design engineer to customize the circuitry utilizing direct wire-to-component connections. TPAs (terminal position assurance locks) give secondary locking protection of the wire leads, which aid in prevention of leads from being pulled out and snap onto the back after wires are installed.

- Accepts 2.8mm components – MINI® fuses, relays, circuit breakers or diodes. (sold separately)
- Cover tethers available to prevent loss of component during service.
- Units are modular and can be dovetailed together to expand circuit protection capacity. They can also be interlocked to other PDMs and fuse holders (FLEC Flexible Electrical Control Center and MEGA/MIDI Flex fuse holder)
- Utilize Delphi Metri-Pack 280 terminals, cable seals and cavity plugs. See datasheet for details.

Datasheet, 3D Models, 2D Prints and additional information: littelfuse.com/HWB

SERIES	PART NUMBERS		MAX CONTINUOUS CURRENT	MAX FUSE RATING PER CIRCUIT	NUMBER OF CAVITIES	MOUNTING TORQUE	INGRESS PROTECTION	DIMENSIONS	TERMINALS (sold separately)		KIT CONTENTS				
	BULK	RETAIL							DELPHI METRI-PACK	TYCO MCP	COVER	Assurelatch	GASKET	TPAs	BRACKET
HWB60-AL	PDM71001ZXM	–	250A	30A	60	4-6 Nm	IP67 & IP69K	113x52x82mm	•		Black	•	•	•	
HWB60	PDM21001LXM	–	250A	30A	60	4-6 Nm	IP67 & IP69K	113x52x82mm	•		Black		•	•	



HWB18

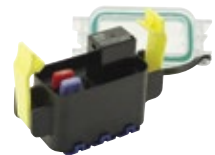

HWB12



HWB6

HWB Series - Compact Sealed Hard-Wired Boxes for 2.8mm Style Fuses & Relays

HWB series hard-wired boxes are sealed units that accept any 2.8mm style fuses, relays, circuit breakers or diodes depending on which HWB model is selected. The HWB series is the perfect fit for accessory circuits and overflow circuits from your main power distribution module.

The series features durable construction, IP67 & IP69K ratings, compact sizes gasket sealed covers and multiple mount types. See chart below for specific details. The HWB series eliminates the use of internal bussing allowing the user or design engineer to customize the circuitry utilizing direct wire-to-component connections. TPAs (terminal position assurance locks) give secondary locking protection of the wire leads, which aid in prevention of leads from being pulled out and snap onto the back after wires are installed.

- Accepts any combination of 2.8mm components – MINI® fuses, relays, circuit breakers or diodes.
- Cover tethers available to prevent loss of component during service.
- HWB12 and HWB 6 units are available with black or clear covers for easy component status identification.
- HWB18 utilize Delphi Metri-Pack 280 terminals, cable seals and cavity plugs. See datasheet for details.
- HWB12 and HWB6 utilize TYCO MCP terminals, cable seals and cavity plugs. See datasheet for details

Datasheet, 3D Models, 2D Prints and additional information: littelfuse.com/HWB

SERIES	PART NUMBERS		MAX CONTINUOUS CURRENT	MAX FUSE RATING PER CIRCUIT	NUMBER OF CAVITIES	MOUNTING TORQUE	INGRESS PROTECTION	DIMENSIONS	TERMINALS (sold separately)		KIT CONTENTS				
	BULK	RETAIL							DELPHI METRI-PACK	TYCO MCP	COVER	Assurelatch	GASKET	TPAs	BRACKET
HWB18	PDM31001ZXM	–	200A	30A	18	5.5-6.5 Nm	IP67 & IP69K	60x38x74mm			Black		•	•	•
HWB18	PDM31002ZXM	–	200A	30A	18	5.5-6.5 Nm	IP67 & IP69K	60x38x74mm	•		Black		•	•	
HWB12	PDM33001ZXM	–	130A	30A	12	5.5-6.5 Nm	IP67 & IP69K	83x70x44mm		•	Clear	•	•	•	
HWB12	PDM33003ZXM	–	130A	30A	12	5.5-6.5 Nm	IP67 & IP69K	83x70x44mm		•	Clear	•	•	•	•
HWB6	PDM32001ZXM	–	68A	30A	6	5.5-6.5 Nm	IP67 & IP69K	71x64x36mm		•	Clear	•	•	•	
HWB6	PDM32003ZXM	–	68A	30A	6	5.5-6.5 Nm	IP67 & IP69K	71x64x36mm		•	Clear	•	•	•	•

Hard-Wired Boxes & Power Distribution Modules

2



HWA20 Series • ATO® Fuse Hard-Wired Box

Compact hard-wired fuse holder holds up to 10 ATO blade fuses, with a combined amperage up to 210A. Perfect for accessory circuits, overflow circuits from main power distribution module, or as a main module on smaller vehicles.

- Without internal bussing: enables the user to customize the circuitry.
- Dovetail slots on the sides of the box interlock with other units.
- Easy to connect wires plug into the back of the unit using industry-standard Tyco sealed power terminals.

Download additional technical information at: littelfuse.com/HWA20

SERIES	PART NUMBERS		MAX CONTINUOUS CURRENT	MAX FUSE RATING PER CIRCUIT	NUMBER OF FUSE LOCATIONS	MOUNTING TORQUE	INGRESS PROTECTION	DIMENSIONS	CONTENTS		
	BULK	RETAIL							COVER	GASKET	TPAs
HWA20	PDM61001ZXM	-	210A	40A	10	4-6 Nm	IP67	161x40x52mm	•	•	•

MTR Series • (2+2) MINI® & JCASE® Fuse Hard-Wired Box



Sealed low to medium current fuse holder houses two JCASE cartridge fuses and two MINI bladed fuses. Holder is gasket-sealed to protect fuses from moisture and contamination. Fuses are internally bussed to a single main power stud – one input powers four fuse circuits. Utilizes the MINI fuse for fast-acting circuit protection and the JCASE cartridge style fuse for enhanced delay for medium current circuits. Output circuits are designed for use with Delphi terminals.

- Cover has positive snap-shut fasteners, and silicone rubber gasket.
- Easy to connect wires plug into the back of the unit using industry-standard Tyco sealed power terminals.

Download additional technical information at: littelfuse.com/MTR

SERIES	PART NUMBERS		MAX CONTINUOUS CURRENT	MAX INPUT CURRENT	NUMBER FUSE LOCATIONS	MOUNTING TORQUE	INGRESS PROTECTION	DIMENSIONS	CONTENTS		
	BULK	RETAIL							COVER	GASKET	TPAs
MTR	BPDMA104HXF1	-	100A	2-60A	4	6-8 Nm	IP67	86x34x77mm	•	•	•



LTX Series • 4 position MEGA® & 2 position MINI® Fuse Box

The LTX Power Distribution Module is a high current sealed primary fuse box that can be placed in the battery box, or near the battery box to fuse major feeder cables. Featuring bussed input to all 6 MEGA® and 2 MIDI® fuses. All bolt down connections are made inside of the seals which enhances the environmental protection of the box.

Download additional technical information at: littelfuse.com/LTX

SERIES	PART NUMBERS		VOLTAGE	MAX CONTINUOUS CURRENT	NUMBER FUSE LOCATIONS	MOUNTING TORQUE	INGRESS PROTECTION	DIMENSIONS	CONTENTS		
	BULK	RETAIL							COVER	GASKET	BUSBAR
LTX	07981002ZXS	-	6-32V DC	240A	6	10-12 Nm	IP66	231x312x60mm	•	•	•



MDB Series • MIDI® Fuse Box

Internally bussed, water-proof and dust-proof fuse holder developed for high current loads, and harsh conditions. The unit is well-suited for near-the-battery applications and can be mounted in exposed locations to fit your design. Available for 2 or 3 MIDI® fuses and includes the cover seal and M5 thread bolts for a fuse installation. Kits include seals, plugs and caps. Fuses are sold separately.

- AssureLatch™ Technology keeps the cover securely in place while allowing for fast service.
- Included tether connects cover to base preventing misplacement.
- The module is internally bussed allowing for high current power distribution.
- Sealed to IP67 and IP69K for maximum flexibility in mounting location.

Download additional technical information at: littelfuse.com/MDB

SERIES	PART NUMBERS		POLES	VOLTAGE	MAX CONTINUOUS CURRENT	MAX FUSE RATING PER CIRCUIT	MOUNTING TORQUE	INGRESS PROTECTION	DIMENSIONS	KIT CONTENTS	
	BULK	RETAIL								INPUT	OUTPUT
MDB	04980932.X	-	2	6-58V DC	200A	200A	6-8 Nm	IP67 & IP69K	131x68x38mm	1x 25 mm ² cap 1x 25 mm ² seal	2x 6-10 mm ² seal 2x 10-16 mm ² seal 1 x plug & 1x 6-16 mm ² cap
MDB	04980933.X	-	3	6-58V DC	200A	200A	6-8 Nm	IP67 & IP69K	131x68x38mm	1x 25 mm ² cap 1x 25 mm ² seal	2x 6-10 mm ² seal 3x 10-16 mm ² seal 1x plug & 1x 6-16 mm ² cap

Power Distribution Modules



LX Series • 200A & 600A • ATO & MIDI Fuse PDM

Protect high and low-amp circuits while providing a collection point for ground returns, and eliminate battery box clutter and damage to battery terminals when adding circuits. Combines an ignition protected fuse block with screw termination. Holds four 30A-200A MIDI fuses and six 1A-30A ATO fuse locations. Negative bus provides common location for ground returns.

Download additional technical information at: littelfuse.com/LX

SERIES	PART NUMBERS		MAX CONTINUOUS CURRENT	MAX FUSE RATING PER CIRCUIT		NUMBER OF FUSE LOCATIONS	TERMINAL STUD TORQUE	INGRESS PROTECTION	DIMENSIONS	CONTENTS		
	BULK	RETAIL		MIDI	ATO					COVER	GASKET	FUSE PULLER
LX	880089	–	600A	170A	30A	10	20 Nm	IP59K	165x127x51mm	•	•	•
	880094	–	200A	170A	30A	10	20 Nm	IP59K	165x127x51mm	•	•	•



XT Series • 350A • ATO & MIDI Fuse PDM

The XT combines an ATO fuse block that has integrated sealed plug outputs (FCI APEX 2.8mm female 4-way connector), and a MIDI fuse block, and consolidates up to seven circuits from 1–200A. Three 30–200A MIDI fuse locations are ideal for high-amp circuits and four 1–40A ATO fuse locations provide for low-amp circuits. Tin-plated copper busbar and stainless steel studs and hardware provides superior corrosion resistance.

Download additional technical information at: littelfuse.com/XT

SERIES	PART NUMBERS		MAX CONTINUOUS CURRENT	MAX FUSE RATING PER CIRCUIT		NUMBER OF FUSE LOCATIONS	TERMINAL STUD TORQUE	INGRESS PROTECTION	DIMENSIONS	CONTENTS	
	BULK	RETAIL		MIDI	ATO					COVER	GASKET
XT	880073	–	350A	170A	30A	7	20 Nm	IP59K	152x102x45mm	•	•



HPDM Series • 600A • High Power MEGA® Fuse PDM

The 2-Pole High Power Distribution Module (HPDM) provides two high current MEGA® fuse protected circuit outputs as well as an un-fused output that can optionally be used to parallel multiple modules or deliver power to circuits which do not require circuit protection or to daisy chain multiple devices. Output studs feature a poka-yoke design to aid in installation.

Download additional technical information at: littelfuse.com/HPDM

SERIES	PART NUMBERS		MAX CONTINUOUS CURRENT	MAX FUSE RATING PER CIRCUIT	NUMBER OF FUSE LOCATIONS	MOUNTING TORQUE	INGRESS PROTECTION	DIMENSIONS	CONTENTS	
	BULK	RETAIL							COVER	GASKET
HPDM	880195400	–	600A	300A	2	30 Nm	IP67 & IP69K	129x125x45mm	•	•

FLEC™ Series • Configurable Flexible Electrical Center

The Flexible Electrical Center (FLEC) is a power distribution module for the commercial vehicle market. It accommodates circuit protection components in a compact, sealed footprint. The PCB accepts active and passive devices.

Part number below is a standard market version. FLEC is configurable to your custom electrical schematic and can be programmed into the FLEC to create a simple “plug-and play” system. Contact Littelfuse for custom FLEC requirements.

- High component density maximizes available space and limits the number of additional units required.
- The versatile nature of the FLEC unit means it can accept a large number of component types. MINI, ATO, MAXI, JCASE, MCASE, and ISO components are all accepted.
- Rugged and sealed, the unit boasts an IP67 rating which allows it to be mounted in locations susceptible to moisture and dirt without any adverse effects
- Input stud caps prevent accidental short circuit while performing maintenance to and around the box.

Download additional technical information at: littelfuse.com/FLEC



PART NUMBER	VOLTAGE	MAX LOAD	MAX FUSE RATING	FUSE CAPACITY	RELAY CAPACITY	INGRESS PROTECTION	OUTPUT CONNECTORS
FLEC3000Z-0	12-24V DC	300A	30A	28	18	IP67	Delphi GT

Fuse Blocks and Holders



Fuse Holders accept fuses to provide electrical protection on circuits. In the following section, there is a wide range of fuse holders from lower current to higher current ratings and in various levels of sealing from moisture and dust. These are all single fuse products. For products accepting multiple fuses, refer to our Power Distribution Module (PDM) product offerings, on page 28 of this catalog.

Where do I need a Fuse Holder?

Fuse holders allow you to install a fuse into an electrical circuit to protect the wiring from the harmful effects of excessive amount of electricity flowing through the cables. The fuse is a replaceable element that will 'blow' to stop the flow of an overload of electricity. If a fuse blows in a circuit, it is important to understand what caused the issue before replacing the fuse, otherwise there is a risk of repeated failures.

Fuses (in fuse holders) should be placed on every wire, as close to the point of the source of power (the battery) as possible. Every time a wire is split or spliced into smaller wires, each of those should be fused. Single fuse holders protect a single wire. A fuse (holder) should be properly sized. Larger diameter wires require larger fuses and smaller diameter wires get smaller rated fuses. Refer to best practices for proper selection fuses for your system

Sealed or Unsealed

Depending where on the vehicle a fuse holder is placed, it may be wise to utilize sealed fuse holders. In all instances, it is wise to try to have the most amount of physical protection of the fuse/fuse holder combination that makes sense. Fuse holders may have simple coverings (to prevent accidental shorting), all the way to completely sealing the fuse and cable to provide protection from moisture and dust in the electrical system. The more exposure to impurities the more risk to the safe and efficient performance of the electrical system as these elements can cause corrosion, and even electrical faults and failures. Some environments however are protected and it may not be necessary to use a sealed fuse holder. Littelfuse offers a wide variety of fuse holders that are moderately to fully sealed.



Bolt-Down Fuse Blocks



MEGA® Bolt-Down Fuse Block

Use with MEGA® fuses up to 250 amps. Ideal for battery and alternator connections and other heavy gauge cables requiring ultra high current protection. Includes protective cover. Features interconnecting pins on side of fuse block for secure multiple block configurations. Includes M8 threaded studs and hex nuts with lock washers. Fuse not included.

Download additional technical information at: littelfuse.com/298

PART NUMBER			DETAILS	VOLTAGE	AMPERAGE	INGRESS	HARDWARE MATERIAL	STUD TORQUE
BOXED 70-PC	BOXED 20-PC	BOXED 10-PC						
02980900Z	02980900S	02980900TXN	Complete Assembly	32V DC	500A	–	–	–

3



MEGA® SN Series Assure-Latch™ Fuse Block

The SN Series is a high amperage in-line MEGA® fuse block with sealed positive latching technology. The fuse holder base and cover are secured together with AssureLatch™ technology to form a water resistant and ignition protected assembly. Fuse not included.

Download additional technical information at: littelfuse.com/SN

PART NUMBER	DETAILS	VOLTAGE	AMPERAGE	INGRESS	HARDWARE MATERIAL	STUD TORQUE	NOTES
880014	Complete Assembly	32V DC	500A	IP66 & IP69K	Tin-Plated Steel	20 Nm	Ignition Protected



Flex-MEGA® Fuse Block

For use with MEGA style bolt-down fuses, up to 500A. With a flexible cover, which permits cable entry from virtually any direction, large wire size, and multiple ring terminal stack up. Dovetail feature allows you to interlock multiple FLEX MIDI fuse holders together for a high power distribution block. Bus bars are available for multiple holder applications and the dovetails enable interlocking of multiple units into a larger assembly. Fuse not included.

Download additional technical information at: littelfuse.com/FLEX-MEGA

PART NUMBER	DETAILS	VOLTAGE	AMPERAGE	INGRESS	HARDWARE MATERIAL	STUD TORQUE	NOTES
02981028HXFC-SS	Complete Assembly	32V DC	500A	–	Stainless Steel	12-18 Nm	–
02981028HXFC	Complete Assembly	32V DC	500A	–	Zinc-Plated Steel	12-18 Nm	–
BUSBAR ACCESSORIES							
882-839-2	2 Position Bus Bar	–	–	–	Tin-Plated Copper	–	For use 2 Fuse Holders
882-839-3	3 Position Bus Bar	–	–	–	Tin-Plated Copper	–	For use 3 Fuse Holders
882-839-4	4 Position Bus Bar	–	–	–	Tin-Plated Copper	–	For use 4 Fuse Holders
882-839-5	5 Position Bus Bar	–	–	–	Tin-Plated Copper	–	For use 5 Fuse Holders



Flex-MIDI® Fuse Block

The FLEX MIDI® fuse holder is used with the MIDI® style bolt-down fuse, which is available up to 200A. This holder offers a flexible cover, which allows cable entry from virtually any direction, large wire size, and ring terminal stack up. Dovetail feature allows you to interlock multiple FLEX MIDI fuse holders together for a high power distribution block. Bus bars are available for multiple holder applications and the dovetails enable interlocking of multiple units into a larger assembly. Fuse not included.

Download additional technical information at: littelfuse.com/FLEX-MIDI

PART NUMBER	DETAILS	VOLTAGE	AMPERAGE	INGRESS	MATERIAL HARDWARE	STUD TORQUE	NOTES
04981038HXFC	Complete Assembly	32V DC	200A	–	Zinc-Plated Steel	3.0-5.0 Nm	–
04982001ZXFC	2-position Assembly	32V DC	200A	–	Zinc-Plated Steel	3.0-5.0 Nm	2 Holders with Busbar
BUSBAR ACCESSORIES							
882-267-002	2 Position Bus Bar	–	–	–	Tin-Plated Copper	–	For use 2 Fuse Holders
882-267-003	3 Position Bus Bar	–	–	–	Tin-Plated Copper	–	For use 3 Fuse Holders
882-267-004	4 Position Bus Bar	–	–	–	Tin-Plated Copper	–	For use 4 Fuse Holders
882-267-005	5 Position Bus Bar	–	–	–	Tin-Plated Copper	–	For use 5 Fuse Holders

In-Line Fuse Holders

3



MIDI® Compact In-line Fuse Holder

Designed for use with bolt-down MIDI style fuses. It can be conveniently installed directly in line with the cables, with no mounting required. The fuse holder is easy to shrinkwrap for an added level of environmental protection, and the corners of the cover are curved so that shrinkwrap will not be split.

Download additional technical information at: littelfuse.com/498-IL

PART NUMBER		DETAILS	AMPERAGE	INGRESS	HARDWARE MATERIAL
BULK 50-PC CARTON	PILLBOX 1-PC (10min)				
04980921.L	04980921.X	Complete Assembly	200A	–	Zinc-Plated Steel



MIDI® In-Line Fuse Holder

Use with MIDI® fuses up to 100 amps. Includes protective cover. Features interconnecting pins on side of fuse block for secure multiple block configurations. Includes M5 threaded studs and hex nuts with lock washers. Fuse not included.

Download additional technical information at: littelfuse.com/498

PART NUMBER	DETAILS	AMPERAGE	INGRESS	HARDWARE MATERIAL
049809216XM5	Complete Assembly	200A	–	Zinc-Plated Steel



MAXI® In-line Blade Fuse Holders with Covers - MAH Series

Use with MAXI Fuse up to 60 amps. Supplied with two 6" wire leads of 6 gauge black wire. Includes protective cover for harsh environment and mounting hole for easy firewall installation.

Download additional technical information at: littelfuse.com/MAH

BOXED PART NUMBERS		DETAILS	AMPERAGE	WIRE DETAILS			PROTECTIVE COVER
MATERIAL NUMBER	CATALOG NUMBER			GAUGE	LENGTH	COLOR	
MAHC0001ZXJ	MAH1	Standard	up to 60A	6	5"	Black	•
MAHC0001ZXJA	MAH1	Standard	up to 60A	6	5"	Red	•



MAXI® In-line Blade Splash Resistant Fuse Holders with Covers - 152 Series

The In-line Splash Resistant Fuse Holder provides an efficient, simple installation method for MAXI® fuse applications in harsh under-the-hood environments

Download additional technical information at: littelfuse.com/152

PART NUMBERS		DETAILS	AMPERAGE	KIT CONTENTS		
BULK 10-PC				SEALS	TERMINALS	COVER
01520003TXN		Holder only	60A			
01520003TXN941		for 4-6mm ² wire	60A	•	•	•
01520003TXN942		for 6-10mm ² wire	60A	•	•	•



MAXI® In-Line Fuse Holders with Optional Covers - MAB Series

Use with MAXI fuses up to 60 amps. Safe/easy replacement for hard to replace fusible link wire. Perfect for high amp audio applications. Interlocking block feature permits two pole position installation. Contains screw terminals. Optional dust cover available.

Download additional technical information at: littelfuse.com/MAB

BOXED PART NUMBERS		CARDED PART NUMBERS		DETAILS	AMPERAGE	OPTIONAL COVER
MATERIAL NUMBER	CATALOG NUMBER	MATERIAL NUMBER	CATALOG NUMBER			
0MAB0001F	MAB1	0MAB0001XP	MAB1BP	High Amp	up to 60A	•

In-Line Fuse Holders

MINI® In-line Blade Fuse Holders with Covers - FHM Series

Use with MINI® Fuse 2 to 20 amps. Supplied with two 4" wire leads of 14 gauge black wire. Includes protective cover for harsh environment. FHM1BP

Heavy Duty MINI® In-line Blade Fuse Holders with Covers - FHM Series

Use with MINI® Fuse 25 and 30 amp fuses. Supplied with two 4" wire leads of 12 gauge orange wire. Includes protective cover for harsh environment. FHM2BP

Download additional technical information at: littelfuse.com/FHM

CARDER PART NUMBERS		DETAILS	AMPERAGE	WIRE DETAILS			PROTECTIVE COVER
MATERIAL NUMBER	CATALOG NUMBER			GAUGE	LENGTH	COLOR	
0FHM0001XP	FHM1BP	Standard	2-20A	14	4"	Black	•
0FHM0002XP	FHM2BP	Heavy Duty	25-30A	12	4"	Orange	•
0FHM0001XPGL0	20-1020	Smart Glow	–	–	4"	Red	•

ATO® In-line Blade Fuse Holders with Covers - FHAC Series

Use with ATO® Fuse 1 to 20 amps. Supplied with two 4" wire leads of 16 gauge black wire. Includes protective cover for harsh environment. FHAC1BP

Heavy Duty ATO® In-line Blade Fuse Holders with Covers - FHAC Series

Use with ATO® 25 and 30 amp fuses for air conditioner or other heavy duty applications. Supplied with two 4" wire leads of 12 gauge orange wire. Includes protective cover for harsh environment. FHAC2BP

Download additional technical information at: littelfuse.com/FHAC

CARDER PART NUMBERS		DETAILS	AMPERAGE	WIRE DETAILS			PROTECTIVE COVER
MATERIAL NUMBER	CATALOG NUMBER			GAUGE	LENGTH	COLOR	
FHAC0001XP	FHAC1BP	Standard	2-20A	16	4"	Black	•
FHAC0002XP	FHAC2BP	Heavy Duty	25-30A	12	4"	Orange	•

ATO® In-line Blade Fuse Holders - FHA Series

Use with ATO® Fuse 1 to 20 amps. Supplied with two 4" wire leads of 16 gauge black wire. FHA1BP

Heavy Duty ATO® In-line Blade Fuse Holders - FHA Series

Use with ATO® 25 and 30 amp fuses for air conditioner or other heavy duty applications. Supplied with two 4" wire leads of 12 gauge orange wire. FHA2BP, FHA30BP includes 30 amp fuse.

Download additional technical information at: littelfuse.com/FHA

BOXED PART NUMBERS		CARDER PART NUMBERS		DETAILS	AMPERAGE	WIRE DETAILS		
MATERIAL NUMBER	CATALOG NUMBER	MATERIAL NUMBER	CATALOG NUMBER			GAUGE	LENGTH	COLOR
–	–	0FHA0001XP	FHA1BP	Standard	1-20A	16	4"	Black
–	–	0FHA0002XP	FHA2BP	Heavy Duty	25-30A	12	4"	Orange
0FHA0030Z	FHA30	0FHA0030XP	FHA30BP	Heavy Duty with 30A Fuse	25-30A	12	4"	Orange
–	–	0FHA0001XPGL0	20-1010	Smart Glow	–	–	4"	Red

ATO® In-line Panel Mount Blade Fuse Holders - AFH Series

Versatile fuse holder for in-line or snap mount panel applications. Interlock body design allows fuse holders to be snapped together. Use with ATO® Fuse 1 to 20 amps. Supplied with 8" loop of 14 gauge black wire. AFH1BP

Heavy Duty ATO® In-line Panel Mount Blade Fuse Holders - AFH Series

Use with ATO® Fuse 25 and 30 amp fuses. Supplied with 8" loop of 10 gauge orange wire. AFH2BP

Download additional technical information at: littelfuse.com/AFH

CARDER PART NUMBERS		DETAILS	AMPERAGE	WIRE DETAILS		
MATERIAL NUMBER	CATALOG NUMBER			GAUGE	LENGTH	COLOR
0AFH0001XP	AFH1BP	Standard	1-20A	14	8" loop	Black
0AFH0002XP	AFH2BP	Heavy Duty	25-30A	10	8" loop	Orange



In-Line Fuse Holders

JCASE® In-Line Cartridge Fuse Holders with Covers - FHJC Series

Two types of in-line fuse holders, with or without bracket, available with 10AWG wire (up to 40A) or 8AWG (up to 60A). Both types have snap-on covers to cover and seal the JCASE fuse.

Download additional technical information at: littelfuse.com/FHJC



PART NUMBERS			DETAILS	AMPERAGE	WIRE DETAILS			BRACKET	PROTECTIVE COVER
BULK 250-PC	BULK 50-PC	BOXED			GAUGE	LENGTH	COLOR		
FHJC1001G	–	–	Standard	up to 40A	10AWG	4"	Red		•
FHJC1002G	FHJC1002L	–	Heavy Duty	up to 60A	8AWG	4"	Red		•
FHJC2002G	FHJC2002L	–	Heavy Duty	up to 60A	8AWG	4"	Red	•	•

JCASE® In-Line Cartridge Fuse Holders - FHJ Series

Two types of in-line fuse holders, with or without bracket, available with 10AWG wire (up to 40A) or 8AWG (up to 60A).

Download additional technical information at: littelfuse.com/FHJC



PART NUMBERS		DETAILS	AMPERAGE	WIRE DETAILS			BRACKET
BULK 250-PC	BOXED			GAUGE	LENGTH	COLOR	
0FHJ1001G	–	Standard	up to 40A	10AWG	4"	Red	
0FHJ1002G	–	Heavy Duty	up to 60A	8AWG	4"	Red	
0FHJ2001G	–	Standard	up to 40A	10AWG	4"	Red	•
0FHJ2002G	–	Heavy Duty	up to 60A	8AWG	4"	Red	•

In-Line Fuse Holders

Glass Fuse In-line Fuse Holders

Holders accept SFE and AGC fuses through 30A. Units are supplied with wire which can be cut and spliced. Holder twist-locks the fuse in place. Available with the fuse.

Download additional technical information at: littelfuse.com/3031



PART NUMBERS			DETAILS	AMPERAGE	WIRE DETAILS		
BULK	BOXED	RETAIL			GAUGE	LENGTH	COLOR
3031-0	3031-0-BX	3031-0-BP	Holder Only	up to 30A	14	8" loop	Black
3031-20	3031-20-BX	3031-20-BP	With 20A Fuse	20A	14	8" loop	Black
3031-30	3031-30-BX	–	With 30A Fuse	30A	14	8" loop	Black

Glass Fuse In-Line Bayonet Knob Fuse Holders • FHP Series

Constructed of tough black thermoset (UL94V0). Includes 3 springs for various fuse sizes and spring-locked, bayonet type knob. Supplied with 15" loop of 14 gauge red wire. Use with Glass SFE 71/2, 9, 14, 20, AGA, AGC, AGW and AGX Fuses up to 20 amps when proper spring is installed.

Download additional technical information at: littelfuse.com/FHP



BOXED PART NUMBERS		DETAILS	AMPERAGE	WIRE DETAILS		
MATERIAL NUMBER	CATALOG NUMBER			GAUGE	LENGTH	COLOR
0FHP0001Z	FHP1	Holder Only	up to 20A	14	15" loop	Red

Glass Fuse In-line Twist-Lock Fuse Holders • FNY Series

Constructed of weather resistant nylon. Simple "twist-lock" allows easy fuse removal and replacement. Supplied with 8" loop of 14 gauge black wire and one spring. Use with Glass SFE 4, 6, 71/2, 9, 14, 20, AGA, AGC, AGW and AGX Fuses up to 20 amps.

Download additional technical information at: littelfuse.com/FNY



CARDERD PART NUMBERS		DETAILS	AMPERAGE	WIRE DETAILS		
MATERIAL NUMBER	CATALOG NUMBER			GAUGE	LENGTH	COLOR
0FNY0001XP	FNY1BP	Holder Only	up to 20A	14	8" loop	Black

Glass Fuse In-Line Heavy Duty Fuse Holders • FNY Series

Spring loaded heavy duty glass fuse holder includes AGC 20A or 30A fuse for GM air conditioner, heater blower motors or other heavy duty applications. Supplied with two 4" wire leads of 12 gauge orange wire. FNY20BP includes 20A AGC Fuse, FNY30BP includes 30A AGC Fuse.

Download additional technical information at: littelfuse.com/FNY



CARDERD PART NUMBERS		DETAILS	AMPERAGE	WIRE DETAILS		
MATERIAL NUMBER	CATALOG NUMBER			GAUGE	LENGTH	COLOR
0FNY0020XP	FNY20BP	With 20A Fuse	20A	12	4"	Orange
0FNY0030XP	FNY30BP	With 30A Fuse	30A	12	4"	Orange

3AG Shock-Safe Panel Mount Fuse Holders

Designed to eliminate the possibility of electrical shock, as defined in IEC standards 65 and 257. Shock-Safe fuse holders feature a low profile body, finger-grip knob and anti-tease feature that eliminates circuit interruption when knob is accidentally depressed.

Approvals: UL listed and CSA Certified. Recognized under the Components Program of UL.

Download additional technical information at: littelfuse.com/fuseholders



CARDERD PART NUMBERS		VOLTAGE	AMPERAGE	TERMINALS
MATERIAL NUMBER	RETAIL			
03453LF2XP	–	250V	20A	¼" straight NEMA/DIN quick connect
03453LF8XP	–	250V	20A	3/16" straight dual purpose solder

Multiple Position Fuse Blocks

ATO® Fuse Blocks with Common Feed



Multi-position black thermoplastic fuse block for ATO® fuses. Contacts are recessed for additional safety and a recession in the center of the block accepts a label.

- Common hot feed – stud terminal is 10-32 with hexnut, flat washer and lockwasher
- Blade terminals are .25" wide (6.4mm)
- Four .218" (5.5mm) diameter mounting holes take #10 screws
- Size: 3.375" wide x .812" high (85.7 x 20.6mm)
- Mounting holes 1.06" (27.0mm) on centers, widthwise.

Download additional technical information at: littelfuse.com/Fuseholders

3

PART NUMBERS			VOLTAGE	MAX CONTINUOUS CURRENT	MAX FUSE RATING PER CIRCUIT	NUMBER FUSE LOCATIONS	DIMENSIONS	MOUNTING HOLES ON CENTERS
BULK	BOXED	RETAIL						
46377-6	-BX	-BP	12-24V DC	150A	25A	6	2.47"L x 3.375"W x .812"H	.625"
46377-8	-BX	-	12-24V DC	150A	25A	8	3.09"L x 3.375"W x .812"H	1.25"
46377-10	-BX	-BP	12-24V DC	150A	25A	10	3.72"L x 3.375"W x .812"H	1.875"
46377-12	-BX	-	12-24V DC	150A	25A	12	4.34"L x 3.375"W x .812"H	2.5"
46377-18	-BX	-	12-24V DC	150A	25A	18	6.22"L x 3.375"W x .812"H	4.375"
46379-6	-BX	-	12-24V DC	150A	25A	6	-	-
46379-8	-BX	-	12-24V DC	150A	25A	8	-	-

ATO® Fuse Blocks with 1/4" Quick Connect Terminals

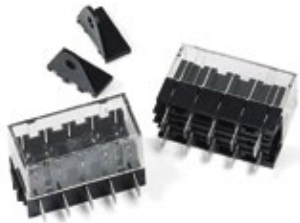

Use with ATO® fuses up to 15 amps. Available in 5 pole unit with removable clear protective cover. Available in side or bottom positioned 1/4" Q.C. terminal configurations. Unit with bottom Q.C. terminals includes detachable side mounting brackets.

Download additional technical information at: littelfuse.com/Fuseholders

PART NUMBERS			DETAILS	AMPERAGE	PROTECTIVE COVER
BULK PART NUMBER 10-PC	CARDED MATERIAL NUMBER	CATALOG NUMBER			
03500417TXN	03500417XP	350417BP	¼" Q.C. side position	2-20A	•
03500418TXN	03500418XP	350418BP	¼" Q.C. bottom position (includes mounting brackets)	25-30A	•

Omni-Blok® Fuse Blocks with 1/4" Quick Connect Terminals



For 1/4" x 1-1/4" glass fuses. Available in one through twelve pole units. Units may be easily broken apart as needed to obtain the desired number of poles. Rated at 20A, 300 V. 354XXX = bulk, OMN = carded.

Download additional technical information at: littelfuse.com/Fuseholders

PART NUMBERS					PART NUMBERS				
BULK	CARDED	POLES	VOLTAGE	AMP	BULK	CARDED	POLES	VOLTAGE	AMP
03540801ZXGY	-	1	300V	20A	354807-GY	-	7	300V	20A
03540802ZXGY	00MN0002XP	2	300V	20A	354808-GY	-	8	300V	20A
03540803ZXGY	-	3	300V	20A	354809-GY	-	9	300V	20A
03540804ZXGY	00MN0004XP	4	300V	20A	354810-GY	-	10	300V	20A
03540805ZXGY	-	5	300V	20A	354811-GY	-	11	300V	20A
03540806ZXGY	-	6	300V	20A	354812-GY	-	12	300V	20A

Multiple Position Fuse Blocks

Common Hot Feed Glass Fuse Block



Fiber base with 11/64" (4.4mm) diameter mounting holes. Solid brass busbar, phosphor-bronze fuse clips. Brass terminals and screws.

Download additional technical information at: littelfuse.com/Fuseholders

PART NUMBERS			MAX FUSE RATING PER CIRCUIT	NUMBER OF POSITIONS	DIMENSIONS	BUSBAR
BULK	BOXED	RETAIL				
M-414-01	-BX	-BP	20A	4	2.75"L x 2.24"W x .625"H	•
M-415-01*	-	-	20A	5	3.50"L x 2.24"W x .625"H	•
M-641-01	-BX	-BP	20A	6	4.25"L x 2.24"W x .625"H	•
M-643-01	-BX	-BP	20A	8	5.75"L x 2.24"W x .625"H	•

3

M-674 • Combination Glass Fuse Block and Terminal Block



Combination Fuse Block & Terminal Block For SFE 20A or 3AG (AGC) fuses. Common hot feed to four independently-fused circuits, and common ground strip for four circuits. Solid brass busbars, terminals and terminal screws. Nickel-plated phosphor-bronze fuse clips. Two eyelet holes for mounting with 3/16" (4.8mm) screws, 2.25" (57.2mm) on centers.

Download additional technical information at: littelfuse.com/Fuseholders

PART NUMBERS			MAX FUSE RATING PER CIRCUIT	NUMBER OF POSITIONS	DIMENSIONS	BUSBAR
BULK	BOXED	RETAIL				
M-674	-BX	-BP	20A	4	3.50"L x 2.75"W x .781"H	•

Laminated Base Fuse Block with Screw Terminals



For 1/4" x 1-1/4" glass fuses. Available in one through twelve pole units. Rated at 20A, 300V.

Download additional technical information at: littelfuse.com/Fuseholders

PART NUMBERS					PART NUMBERS				
BULK	CARDED	POLES	VOLTAGE	AMP	BULK	CARDED	POLES	VOLTAGE	AMP
03560001Z	-	1	300V	20A	03560007Z	-	7	300V	20A
03560002Z	-	2	300V	20A	03560008Z	-	8	300V	20A
03560003Z	-	3	300V	20A	03560009Z	-	9	300V	20A
03560004Z	-	4	300V	20A	03560010Z	-	10	300V	20A
03560005Z	-	5	300V	20A	03560011Z	-	11	300V	20A
03560006Z	-	6	300V	20A	03560012Z	-	12	300V	20A

*Special Order Item

Power Feed

3



ATO® Add-A-Circuit™ Kit

Allows easy installation of additional circuits without cutting or splicing. Turns one fuse slot into two while providing protection for both circuits. Maintains new car warranty. Use with ATO® Fuses up to 10 amps. Includes ATO 3, 5, 7.5 and 10 amp fuses.

BOXED PART NUMBERS		CARDED PART NUMBERS	
MATERIAL NUMBER	CATALOG NUMBER	MATERIAL NUMBER	CATALOG NUMBER
0FHA0200Z	FHA200	0FHA0200ZP	FHA200BP



MINI® Add-A-Circuit™ Kit

Same as ATO® Add-A-Circuit except for use with MINI® Fuses up to 10 amps. Includes MINI 3, 5, 7.5 and 10 amp fuses.

BOXED PART NUMBERS		CARDED PART NUMBERS	
MATERIAL NUMBER	CATALOG NUMBER	MATERIAL NUMBER	CATALOG NUMBER
0FHM0200Z	FHM200	0FHM0200ZP	FHM200BP



LPMINI® Add-A-Circuit™ Kit

Same as ATO® Add-A-Circuit except for use with LPMINI® Fuses up to 10 amps. Includes LPMINI 3, 5, 7.5 and 10 amp fuses.

BOXED PART NUMBERS	CARDED PART NUMBERS
MATERIAL NUMBER	MATERIAL NUMBER
FHLM0200Z	FHLM0200ZPA



MICRO2® Add-A-Circuit™ Kit

Same as ATO® Add-A-Circuit except for use with MICRO2® Fuses up to 10 amps. Includes MICRO2 3, 5, 7.5 and 10 amp fuses.

BOXED PART NUMBERS	CARDED PART NUMBERS
MATERIAL NUMBER	MATERIAL NUMBER
FHM20200Z	FHM20200ZPA



Battery Power Feed Kit

Attaches directly to battery terminal. Allows the addition of up to 3 circuits. Includes MINI® fuse in-line fuse holder with protective cap. Also can be used as a frame ground. Constructed of durable brass for optimal conductivity.

CARDED PART NUMBERS	
MATERIAL NUMBER	CATALOG NUMBER
0BPF0001ZP	BPF1BP

Caution: Fusetaps are not a recommended alternative for adding circuits because they can stress the terminals in the fuse block. This situation can create a loose fitting fuse, which in turn produces excessive heat, which can cause nuisance blows, even melting of the fuse and fuse block and possibly an expensive repair in the future. When a fusetap is used, in many cases there is no fuse protecting the new circuit, a condition which can also present a hazard.

Fuse Pullers and Battery Accessories



Fuse Tester and Puller

Conveniently and easily tests ATO® and MINI® blade fuses either in or out of the fuse block, with or without vehicle battery power. Indicator light on tester glows bright green when fuse is good. Fuse puller end allows for easy fuse removal and replacement. 24V maximum.

Fuse Pullers

Fuse puller allows for easy fuse removal and replacement.

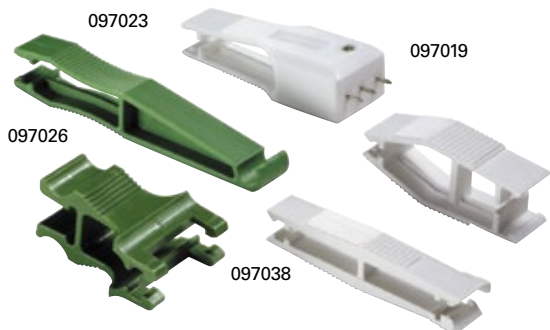

BOXED PART NUMBERS		CARDED PART NUMBERS		DESCRIPTION
MATERIAL NUMBER	CATALOG NUMBER	MATERIAL NUMBER	CATALOG NUMBER	
00970019X	097019	00970019XP	097019BP	For ATO® & MINI® Fuses
00970023Z	097023	00970023XP	097023BP	Tri-Puller™ – for Glass Fuses, Ceramic Type Fuses, ATO® and MINI® Blade Fuses
00970026N	097026	00970026XP	097026BP	For MAXI Blade Fuses
–	–	00970035XP	–	
00970038Z	097038	00970038XP	–	For ATO® and MINI® Fuses
–	–	00970053XP	–	For JCASE® Fuses
00970025N	–	00970025XPA	–	For Micro2 / Micro3 Fuses
00970054N	–	00970054XPA	–	For MCase Fuses

Anti-Theft Battery Master Switch



- Available in two versions, Fused and Detachable.
- Fused version maintains current to all electrical circuits such as the alarm, on-board computer, central locking system and radio memory presets.
- Detachable version features a special disconnect that allows the battery to easily be removed for anti-theft protection. Perfect for seasonal storage needs or easy off vehicle battery charging for Autos, Motorcycles, RV's, Boats, etc.
- Generate sales with the lowest cost anti-theft devices available on the market today.
- A simple turn of the knob isolates the battery and makes the vehicle unable to start.
- Makes anti-theft protection affordable when compared to expensive alarm systems.
- Eliminates complicated installation — no special electrical or mechanical expertise required.
- Fits all standard Top Mount Post batteries. Can be used with Side Mount Post batteries by using a Top Mount Adapter Post (not included).
- Works on 12 to 24 volt systems up to 135 amperes.

CARDED PART NUMBERS		DESCRIPTION
MATERIAL NUMBER	CATALOG NUMBER	
0ATD0200XBP	ATD200BP	Anti-theft Battery Master Switch – Detachable
0ATD0300ZBP	ATD300BP	Anti-theft Battery Master Switch – Fused

Battery Management



Isolators or Combiners?

Battery Isolators are passive (not intelligent) devices. They are a basic technology that prevents current from draining from one battery into the other. As current passes through the internal diodes there's a loss of efficiency, that equates to a voltage loss of 10-15%. Another problem arises when battery isolators are used with the more recent 'smart alternators'. Such alternators incorporate sensors which 'read' the state of the battery, but the isolator's diodes interfere with the alternator's sensors. It is therefore important to use a battery combiner in this application.

Battery combiners provide the same function as isolators, but without the substantial voltage loss, and they work in harmony with smart alternators. They also may have additional useful features, such as boost; they are smaller and lighter; and since they are installed between the battery banks, there is no need to cut the original OEM heavy cable from alternator to battery.

No More Dead Batteries!

If you leave a fully charged battery connected in an inactive vehicle, it could be dead in as little as two months. Vehicles have electronics that continue to draw small quiescent currents to maintain their memory, even when the vehicle is off. Over an extended period of time this small current can drain the battery. Complete discharge of the battery can cause permanent damage and prevent proper battery recharging.

If your vehicle requires short or long term storage and has a lot of electronics (computer, TV, stereo, etc) a Low Voltage Disconnect can be installed to automatically disconnect these components when battery voltage falls below a critical threshold and automatically reconnects when the battery is recharged. This lengthens the storage life of your battery.

85-200A Smart Battery Isolators



Battery Combiners are hybrid electronic/electromechanical relays that prevent loads on the auxiliary battery from draining the starting battery. This type is more flexible than Diode Battery Isolators: works with all types of alternator; it is smaller and lighter; no efficiency loss due to diodes; allows bi-directional charging from the alternator or from shore power; reduces the load on the charging system by not connecting the auxiliary battery until the primary battery is charged to 13.2V.

- Works with most types of alternators
- Smaller and lighter than traditional isolators
- No efficiency losses due to diodes
- Allows bi-directional charging from the alternator or from shore power
- Reduces the load on the charging system by not connecting the auxiliary battery until the primary battery is charged to 13.2V extending the life of expensive charging components.

Datasheet, wiring diagram, and 2D prints: littelfuse.com/BatteryManagement

PART NUMBERS		AMPS	VOLTAGE	TERMINAL STUDS	INGRESS PROTECTION	CONNECT VOLTAGE	DISCONNECT VOLTAGE	QUIESCENT CURRENT	TERMINAL STUD TORQUE
BULK	INDIVIDUAL BOX								
48525	48525-BX	85A	9-16V DC	5/16-24"	IP66	13.2V typical after 2min	12.7V after 1min	5mA typical, 8mA max	35 in-lbs (3.95Nm)
48530	48530-BX	200A	9-16V DC	5/16-24"	IP66	13.2V typical after 2min	12.7V after 1min	5mA typical, 8mA max	35 in-lbs (3.95Nm)

4

3 & 4 Stud Diode Battery Isolators

For vehicles with two batteries, these devices electrically isolate the batteries to prevent the battery with the higher charge from draining into that with the lower charge. In addition, both batteries can be charged simultaneously from one source.

The solid-state components are embedded to give excellent protection from adverse conditions, such as contamination and vibration. The integral heat sink provides efficient heat dissipation. The amp rating of each item is the maximum alternator rating.

Some alternators on vehicles have an integral electronic voltage regulator that requires the use of the 4-stud battery isolator. The small 4th stud is for connection to a circuit switched by the ignition switch. The newer alternators were first introduced by Delco and are therefore sometimes called 'Delcotron-type alternators'. Battery Isolators have a 'per leg' rating which indicates the maximum current that it can deliver to each battery. All Battery Isolators have a per leg rating equal to half the alternator rating. Thus a 48122 battery isolator with an alternator rating of 140A has a per leg rating of 70A per leg.

Additional information: littelfuse.com/BatteryManagement

Schottky Diode - Comply to KKK-A-1822B spec for Ambulances



PART NUMBERS			AMPS	VOLTAGE	TERMINALS		DIMENSIONS	ALTERNATOR TYPE
BULK	INDIVIDUAL BOX	NUMBER OF STUDS			THREADS			
48051	48051-BX	75A	12V DC Only	2	2x 1/4"	3-1/2" x 4-15/16" x 3-11/32"	-	
48161	48161-BX	250A	12-36V DC	3	3x 5/16"	8-1/2" x 4-3/16" x 3-13/32"	-	
48092*	48092-BX*	90A	12-36V DC	4	3x 1/4" & 1x #10	6-1/2" x 3-3/4" x 2-13/16"	Delcotron-Type	
48122	48122-BX	140A	12-36V DC	4	3x 5/16" & 1 #10	6" x 4-3/16" x 3-11/32"		
48162	48162-BX	200A	12-36V DC	4	3x 5/16" & 1 #10	8-1/2" x 4-3/16" x 3-13/32"		
48070	48070-BX	70A	12-36V DC	3	3x 1/4"	5" x 3-3/4" x 2-3/16"		
48090	48090-BX	90A	12-36V DC	3	3x 1/4"	6-1/2" x 3-3/4" x 2-13/16"	Without Integral Electronic Voltage Regulator	
48120	48120-BX	140A	12-36V DC	3	3x 5/16"	6" x 4-3/16" x 3-11/32"		
48160	48160-BX	200A	12-36V DC	3	3x 5/16"	8-1/2" x 4-3/16" x 3-13/32"		

3- Stud Wiring Diagram

48070, 48080, 48090, 48160 and 48161

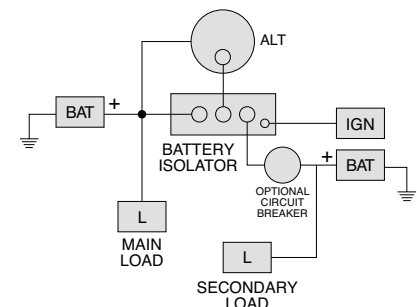

*Special Order Item

Battery Combiners & FlexMod™ Devices



HD Series • 300A Bi-Stable Battery Combiner

- Intelligent relay shares charge voltage between two battery banks.
- Combines battery banks when one is being actively charged
- Disconnects them when charge voltage is removed.
- Use with high amperage smart alternators supplied in many full size pick-up trucks

Additional technical information: littelfuse.com/BatteryCombiners

PART NUMBERS		AMPS	VOLTAGE	TERMINAL STUDS	SEALING
BULK					
880051		300A Max	12V DC	3/8"	IP67 & IP69K
880055		300A Max	24V DC	3/8"	IP67 & IP69K

FlexMod Electronic Devices

The FlexMod™ Series of products are compact, robust electronic modules with two inputs (one analog and one digital) and two solid state outputs (one 10A, one 200 mA) that can be programmed to do almost any job. Littelfuse offers standard units listed below to meet the most common application needs.

Additional technical information: Littelfuse.com/FlexMod

- Auto-ranging to automatically senses the voltage of the system (12 or 24V) and selects the presets appropriate to that voltage.
- Ultra low 1mA standby current means minimal battery drain – especially valuable when vehicle is in storage or not in use.
- Factory programmable unit is highly versatile: with a broad range of presets available to match any special application.
- Rated for more than 1,000,000 on-off cycles – unit operates for the lifetime of the vehicle. Solid state technology gives long life and low maintenance.
- Provides overvoltage and overcurrent protection to every direct load in that circuit– gives extra levels of protection.
- Small lightweight sealed design – Uses less space; mounts outside or inside. Saves money by eliminating other hardware, and provides better wire routing



PART NUMBERS		TYPE	HARNESS INCLUDED
BULK	INDIVIDUAL BOX		
48636	48636-BX	Timer for Trailer Lighting	
48636-01	48636-01-BX	Timer for Trailer Lighting	•
48535	–	Liftgate Protector	
48535-01	–	Liftgate Protector	•
48736	48736-BX	Timer for Interior Lighting	
48610	48610-BX	Low Voltage Disconnect	
48610-01*	48610-01-BX*	Low Voltage Disconnect	•
48541	48541-BX	Voltage Sensing Relay & Timer	
48541-01	48541-01-BX	Voltage Sensing Relay & Timer	•
48540	48540-BX	Smart Battery Isolator Controller	
48540-01	48540-01-BX	Smart Battery Isolator Controller	•

Low Voltage Disconnect - 48610: Preserves battery charge and protects battery banks by automatically disconnecting loads when battery voltage drops to a critical level.

Timer for Interior Lighting - 48636: Prevents the internal lights inside a trailer from being left on and draining the battery. Vehicle operator turns lights on with a momentary switch, allowing safe operation inside the cargo compartment. After 20 minutes the FlexMod flashes the lights and gives increasingly urgent warnings to exit the cargo compartment or reactivate the timer before the lights go out.

Smart Battery Isolator Controller - 48540: Monitors two battery banks and controls one relay or contactor to make sure starting power is protected by isolating the starting and auxiliary battery banks.

Voltage Sensing Relay & Timer - 48541: Monitors both battery voltage and ignition status, shutting down non-critical loads when the cutoff voltage is reached, or at the set time after the ignition is turned off. It is a timer and voltage sensor in one easy-to-connect unit.

Liftgate Protector - 48535: Prevents damage to batteries and liftgate motor. When the liftgate is actuated, the unit checks the battery voltage, if the voltage is above a pre-set level, it enables the liftgate to work. If voltage falls, the unit activates an alarm and prevents activation of the liftgate.

*Special Order Item

100-250A – SureStart™ Compact Low Voltage Disconnects



48513



48514

SureStart™ Low Voltage Disconnects (LVD) electronically senses battery voltage and conserves starting power, by automatically disconnecting and reconnecting loads based on battery condition. When battery voltage falls below the programmed voltage setting for 2 minutes, non-critical loads are automatically disconnected. This operation prolongs battery life by preventing damage due to excessive discharge.

- Auto-sensing 12-24 voltage range from 100-250A
- Compact size and lightweight for discrete mounting
- Waterproof and dustproof to IP67
- Convenient kits offer sealed harness and rocker switch for easy ordering

Additional information: littelfuse.com/BatteryManagement

PART NUMBERS		AMPS	VOLTAGE	DIMENSIONS	CONNECTOR	SEALING	INCLUDED ACCESSORIES		
BULK	INDIVIDUAL BOX						HARNESS	ROCKER SWITCH	TOGGLE SWITCH
48513	–	100A at 85°C 125A at 60°C	12 or 24V DC	4.3" x 4.5" x 3.1"	Deutsch Type DT06-4S	IP67			
48513-01	48513-01-BX						•		
48513-02	48513-02-BX						•	•	
48513-03	48513-03-BX							•	
48514	48514-BX	250A at 85°C	12 or 24V DC	6.57" x 4.33" x 2.36"	Deutsch Type DT06-4S	IP67			
48514-01	–						•		
48514-02	–						•	•	

150-200A - SureStart™ Standard Low Voltage Disconnects

SureStart™ LVDs automatically disconnect non-critical loads from battery when voltage falls below a predefined threshold. Automatically reconnects the loads to the battery when it is being charged. Manual override permits a user to make or break the connection, regardless of voltage.

- Automatically disconnects non-critical loads from a battery when the battery voltage falls below a predefined threshold.
- Automatically reconnects the loads to the battery when the battery is being charged.
- Automatically prevents the loads from disconnecting during starting.

Additional information: littelfuse.com/BatteryManagement

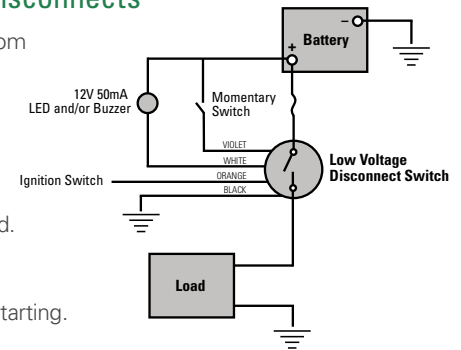

PART NUMBERS		AMPS	VOLTAGE	DIMENSIONS	CONNECTOR	TERMINALS	SEALING
BULK	INDIVIDUAL BOX						
48512	48512-BX	150A	9-16V DC	6.0" x 5.13" x 3.0"	4x 18 Gauge Wire Leads	5/16-18"	IP67
48510	48510-BX	200A					

LGBC Series - Liftgate Battery Charger

Ensures that trailer/liftgate batteries are charged fast and efficiently by boosting the charging voltage and monitoring liftgate battery status. The unit helps compensate for common issues such as liftgate batteries being drained too fast, and charging voltages too low to keep the batteries charged.

- Adjusts charging current according to resistance caused by the tractor-trailer connector and compensates for electrical loads (lights, brakes, etc.) to maximize battery charge.
- Selector switch on the unit ensures optimal charge profile for AGM or flooded lead acid batteries.
- Three stage battery charging (Bulk, Absorption and Float) maximizes battery life.

Datasheet, 2D prints and additional information: littelfuse.com/LGBC



PART NUMBERS		MAXIMUM OUTPUT (A)	VOLTAGE	INGRESS PROTECTION	DIMENSIONS	BATTERY TYPE		KIT CONTENTS		
BULK	INDIVIDUAL BOX					AGM	FLA	UNIT	HARNESS	FUSES
880209	–	20	9.5-16V DC	IP67 & IP69K	143 x 192 x 60 mm	•	•	•		
880210	–	35	9.5-16V DC	IP67 & IP69K	143 x 192 x 60 mm	•	•	•		
880211	–	35	9.5-16V DC	IP67 & IP69K	143 x 192 x 60 mm	•	•	•	•	•



Relays & Solenoids

DC solenoids are relays used for remote switching of electrical currents from 20A to 600A. Littelfuse offers a variety of DC solenoids and relays, such as solid state relays, plug-in relays, compact relays among others.



Solenoids or Relays?

The terms solenoid and relay are interchangeable and refer to a type of remote switch. In the automotive context, solenoid refers to the metal can device. A relay refers to all other such devices including the small micro relays referenced later in this section. The word solenoid actually refers to the helical windings that create the magnetic force which pulls the plunger in the core. Littelfuse manufactures a very broad range of remote switches.

Intermittent or Continuous?

Relays are rated for Intermittent Duty or Continuous Duty. Intermittent duty relays are rated with maximum On times and minimum Off times, which is a workable situation in many applications. Exceed those specs and you run the risk of burning out the coil windings. You cannot use an Intermittent Duty relay for continuous service, but you can use a Continuous Duty relay for intermittent service – although you would be purchasing a relay that is in excess of your needs.

Bistable & Latching?

When it comes to solenoids or relays, both bi-stable and latching refer to the same function. A bi-stable state is one in which a moving contact is at rest in two configurations, either the On or Off position. This is achieved by a mechanical or magnetic latching mechanism which maintains contact in the ON or OFF position while device is not energized. A more well-known example of the mechanical style is the mechanism of a retractable ballpoint pen, where the user pushes to move the ballpoint out of the housing, and pushes again to retract the ballpoint. The point remains in either of two stable states until the user presses the actuator.

In standard solenoids or relays, a control current has to be maintained in order to keep the plunger in the On position; in a bi-stable relay, control current is only applied when changing between the two states of Off and On. This provides many advantages – no current is used in the On or Off states, and bi-stable relays generate less heat.



48716 • 250A High-Amp Programmable Solid State Relay



Units are resistant to high vibration and exposure to roadsplash and salt spray and can be mounted in inaccessible places, compared to electromechanical types which need to be accessible for potential replacement. This reliable unit is protected from over-temperature, overcurrent, overvoltage, and under-voltage.

- Sealed Deutsch connector.
- Minimal stand-by 1mA draw on battery.
- Protects vulnerable onboard electronics such as GPS, phone, computer.
- Solid-state switching creates less electrical noise and interference, and eliminates spikes.

Units are distributor-programmable.

PART NUMBERS			VOLTAGE		AMPERAGE	FORM	INGRESS	DIMENSIONS
BULK	INDIVIDUAL BOX	RETAIL CLAMSHELL	12V DC	24V DC	250A Continuous	Normally Open or Bi-Stable	IP67	6.6 x 4.8 x 3.0 in (167.0 x 122.0 x 76.0 mm)
48716	-	-			500A (3 sec) Intermittent			

48715 • 100A Programmable Solid State Relay



Units are resistant to high vibration and exposure to roadsplash and salt spray and can be mounted in inaccessible places, compared to electromechanical types which need to be accessible for potential replacement. This reliable unit is protected from over-temperature, overcurrent, overvoltage, and under-voltage.

- Sealed Deutsch connector.
- Minimal stand-by 1mA draw on battery.
- Protects vulnerable onboard electronics such as GPS, phone, computer.
- Solid-state switching creates less electrical noise and interference, and eliminates spikes.

Units are distributor-programmable.

PART NUMBERS			VOLTAGE		AMPERAGE	FORM	INGRESS	DIMENSIONS
BULK	INDIVIDUAL BOX	RETAIL CLAMSHELL	12V DC	24V DC	100A Continuous	Normally Open or Bi-Stable	IP67	4.5 x 4.3 x 3.1 in (114.3 x 108.6 x 79.0 mm)
48715	-	-			300A (5 sec) Intermittent			

48521 • 200A Electronic Dual Relay



Ideal in situations where traditional solenoids are showing high failure rates due to vibration or ingress from roadsplash, or in applications that wear out traditional solenoids due to arcing.

- Normally open relay or bi-stable relay, depending on which wires are connected by the user
- Low control and quiescent currents
- Protected against reverse polarity, overcurrent, short circuit and overheating

PART NUMBERS			VOLTAGE	AMPERAGE	FORM	INGRESS	DIMENSIONS
BULK	INDIVIDUAL BOX	RETAIL CLAMSHELL	12V DC	200A Continuous	Normally Open or Bi-Stable	IP67	4.85 x 6.0 x 3.0
48521	48521-BX	-					

48785 • 85A Electronic Relay/Switch



Fully solid-state with no moving parts to wear out that is completely sealed, ignition protected and designed to withstand vibration for harsh environments. Relays can be used in both high side and low side switching application and are suitable for high inrush demand circuits.

- Resistance: .005 Ω
- Control Current: .02A max
- Temperature Range: -40°C to +85°C
- On-Off Cycles: 20 million

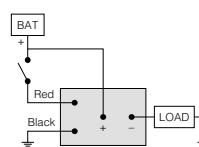

High side switching application

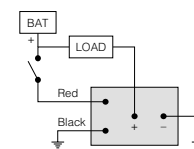

Low side switching application

PART NUMBERS			VOLTAGE	AMPERAGE	FORM	INGRESS	DIMENSIONS
BULK	INDIVIDUAL BOX	RETAIL CLAMSHELL	9-31V DC	85A Continuous	-	IP67	3.0 x 5.0 x 2.9 in
48785	48785-BX	-		175A Intermittent			

Standard High Current Relays

6-36V DC • 35-200A • Continuous Duty Solenoids

- Hex nuts and lock washers are included
- Steel housing mounting holes: 5/16 x 19/32," 2 13/64" on centers (7.9 x 15.1, 56.0mm)
- Plated steel housing available with optional PVC coating available to protect critical components from environmental hazards

Datasheet, wiring diagram, and additional pack sizes: littelfuse.com/ContinuousDutySPST

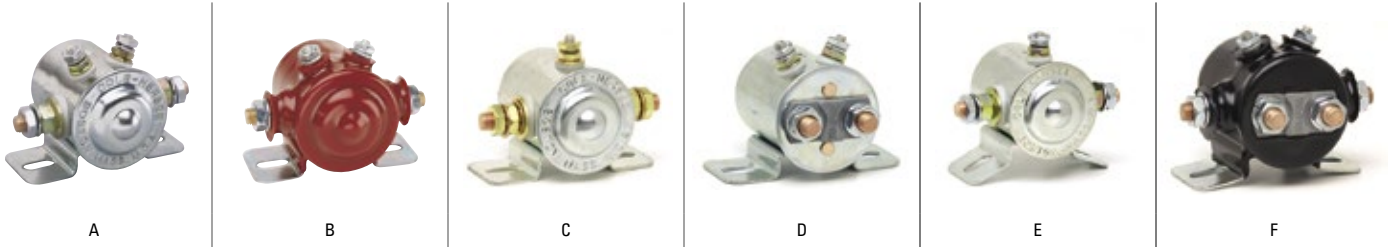

5

PART NUMBERS			VOLTAGE	AMPS	INSULATED / GROUNDED	CIRCUITRY	FORM / CONTACTS	PVC COATED	CONTACT TERMINALS		SMALL TERMINALS	UL LISTED	IMAGE	DIAGRAM	NOTES
BULK	INDIVIDUAL BOX	RETAIL CLAMSHELL													
24080	24080-BX	-	36	85	Insulated	SPST	NO		Copper	5/16"-24	Steel 10-32"		A	1	Intermittent rating: 125A Make, 65A Break 10 sec on, 30 min off - UL Requirement
24080-01	-	-		65	Insulated	SPST	NO		Copper	5/16"-24		•	A	1	
24135	-	-	85	Insulated	SPST	NO	•	Copper	5/16"-24			B	1		
24063	24063-BX	-	85	Insulated	SPST	NO		Copper	5/16"-24			A	1		
24063-08	24063-08-BX	-	85	Insulated	SPST	NO	•	Copper	5/16"-24	•		B	1		
24214	24214-BX	-	24	200	Insulated	SPST	NO		Silver	5/16"-24			A	1	
24107	24107-BX	-		85	Insulated	SPST	NO		Copper	5/16"-24			C	2	
24124	24124-BX	-	85	Grounded	SPST	NO		Copper	5/16"-24			C	4		
24115	24115-BX	-	85	Insulated	SPST	NO		Copper	5/16"-24			C	3		
24059	24059-BX	24059-BP	85	Insulated	SPST	NO		Copper	5/16"-24			A	1		
24059-08	24059-08-BX	24059-08-BP	12	65	Insulated	SPST	NO		Copper	5/16"-24	•	A	1	Intermittent rating: 750A Make, 100A Break 10 sec on, 30 min off - UL Requirement	
24117	24117-BX	-			Insulated	SPST	NO	•	Copper	5/16"-24		B	1		
24117-01	24117-01-BX	24117-01-BP		Insulated	SPST	NO	•	Copper	5/16"-24		B	1			
24213	24213-BX	-	200	Insulated	SPST	NO		Silver	5/16"-24		A	1			
24420	24420-BX	-	35	Insulated	SPST	NC		Copper	5/16"-24		D	5			
24106	24106-BX	-	85	Grounded	SPST	NO		Copper	5/16"-24		C	4			
24082	24082-BX	-	85	Grounded	SPST	NO		Copper	5/16"-24		E	4	Curved Bracket		
24097	24097-BX	-	6	85	Grounded	SPST	NO		Copper	5/16"-24		A	1		
24401-04	24401-04-BX	-	12	-	Insulated	SPDT	NO/NC	•	Copper	5/16"-24		F	6	Normally Closed: 35A Normally Open: 85A	

Continuous Duty Solenoid Wiring Diagrams

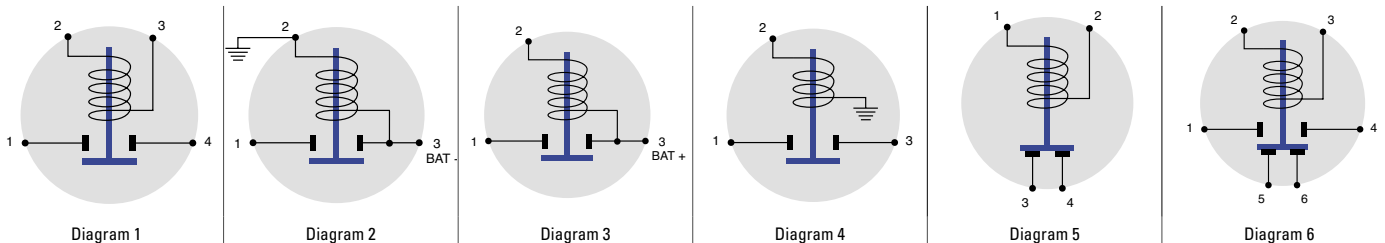

Standard High Current Relays

12V DC • Intermittent Duty Solenoids

- Hex nuts and lock washers are included
- Steel housing mounting holes: 5/16 x 19/32," 2 13/64" on centers (7.9 x 15.1, 56.0mm)
- Phenolic housing mounting holes: 9/32 x 25/64," 2 7/64" on centers (7.1 x 9.9, 53.6mm)
- Solenoids available in phenolic, plated steel or PVC coated housings to protect critical components from environmental hazards
- Resistor shorting circuit solenoids (p/n 24103/24021) feature a 3 that is normally open and becomes common with 1 and 4 when the solenoid is energized. Commonly used in engine starting applications.

Datasheet, wiring diagram, and additional information: littelfuse.com/IntermittentDutySPST

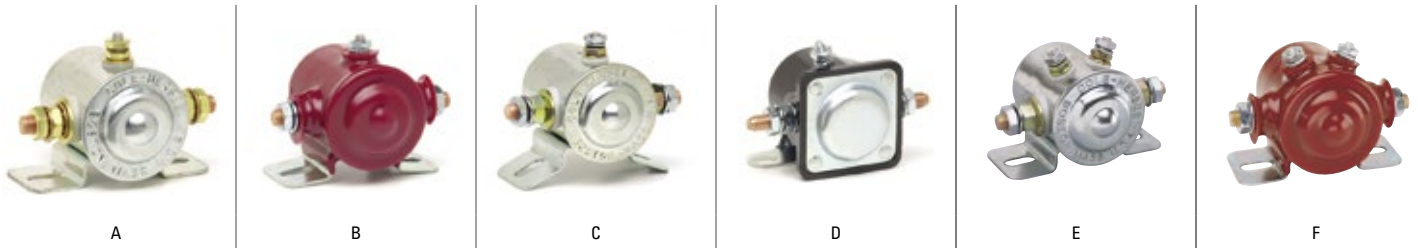

PART NUMBERS			VOLTAGE	AMPS		DUTY CYCLE	INSULATED / GROUNDED	CIRCUITRY	FORM / CONTACTS	HOUSING MATERIAL	CONTACT TERMINALS	SMALL TERMINALS	IMAGE	DIAGRAM	NOTES
BULK	INDIVIDUAL BOX	RETAIL CLAMSHELL		MAKE	BREAK										
24037	24037-BX	-	12	750A	100A	On: 10 sec Off: 20 min	Grounded	SPST	NO	Plated Steel	Copper 5/16" -24 threads	Copper 10-32	A	1	
24071	24071-BX	-								PVC Coated			B	1	
24044	24044-BX	-								Plated Steel			C	1	Curved Bracket
24022	24022-BX	-								Phenolic			D	1	
24103	24103-BX	-								Plated Steel			E	3	Resistor Shorting Circuit
24021	24021-BX	-								Phenolic			D	3	Resistor Shorting Circuit
24047	24047-BX	-					Plated Steel			E			4		
24076	24076-BX	-					PVC Coated			F			4		
24060	24060-BX	-					Plated Steel			A			5		
24046	24046-BX	-					Plated Steel			A			6		
24023	24023-BX	-					Phenolic			D			2		

Intermittent Duty Solenoid Wiring Diagrams

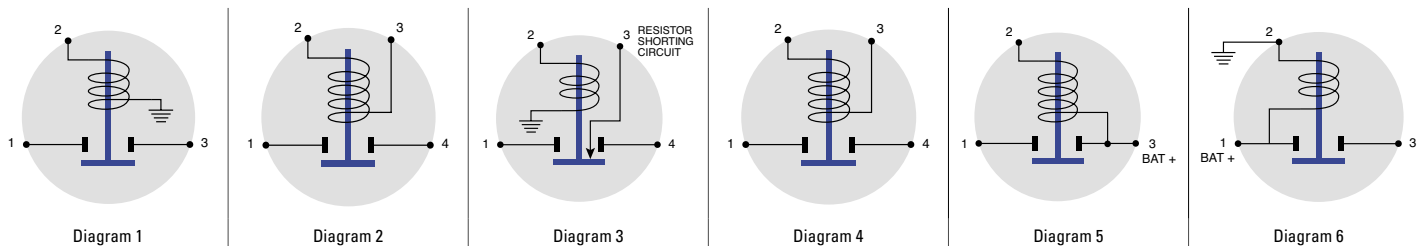

Standard High Current Relays

Continuous Duty Two Circuit Solenoids

Special applications: Forward and reverse systems in electric golf carts, garden tractors, fork lift trucks, winches, etc.

- Hex nuts and lock washers are included
- Mounting holes: 5/16 x 19/32," 2 13/64" on centers (7.9 x 15.1, 56.0mm)

Datasheet, wiring diagram, and additional information: littelfuse.com/ContinuousDutyDPST

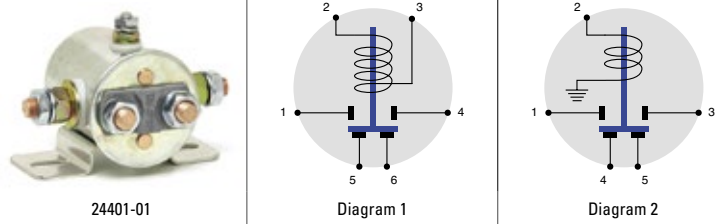

PART NUMBERS			VOLTAGE	AMPS		COIL TYPE	CIRCUITRY	PVC COATED	CONTACTS		TERMINALS	DIAGRAM
BULK	INDIVIDUAL BOX	RETAIL CLAMSHELL		NC	NO				MATERIAL	THREADS		
24402	24402-BX	—	24			Insulated	DPST	—	Copper	5/16"-24	Steel 10-32"	1
24401	24401-BX	—		35	85			—				
24401-04	24401-04-BX	—	12			Grounded	—	•				1
24401-01	24401-01-BX	—						—				

5

100-225A • Heavy Service Plastic Body Solenoids

For starting small engines, including lawn tractors, golf carts and sweepers.

- Small ignition and ground terminals are 10-32 thread
- Large contact terminals are 5/16" -24 thread.

Additional information: littelfuse.com/PlasticBodyRelays

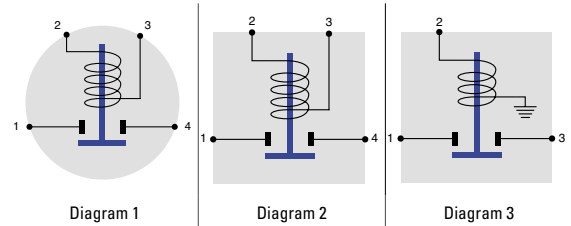

24848 - L-Bracket



24624-10 - F-Bracket



24612-10 - F-Bracket

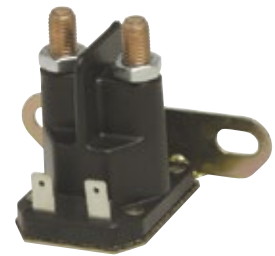

24512-10 - Bracket

PART NUMBERS			TYPE	VOLTAGE	MAX VOLTAGE	AMPS		COIL TYPE	CIRCUITRY	FORM / CONTACTS	MOUNTING BRACKET	CONTACTS	COIL TERMINALS	DIAGRAM	SEALED
BULK	INDIVIDUAL BOX	RETAIL CLAMSHELL				MAKE/BREAK	INRUSH								
24848*	—	—	Continuous Duty	48	48	225	600	Insulated	SPST	NO	L-Bracket	Silver 5/16"-24	10-32 studs	1	
24824-01	24824-01-BX	—		24	—	225	600	Insulated	SPST	NO	L-Bracket	Silver 5/16"-24	10-32 studs	1	
24812	24812-BX	—		12	14	225	600	Insulated	SPST	NO	L-Bracket	Copper 5/16"-24	10-32 studs	1	
24812-01	24812-01-BX	—		12	14	225	600	Insulated	SPST	NO	L-Bracket	Silver 5/16"-24	10-32 studs	1	
24624-10	24624-10-BX	—		24	27	100	400	Insulated	SPST	NO	F-Bracket	Silver 5/16"-24	10-32 studs	2	
24512-10	24512-10-BX	—		12	14	100	400	Insulated	SPST	NO	F-Bracket	Silver 5/16"-24	Blade	2	
24612-10	24612-10-BX	—	Intermittent Duty	12	14	100	400	Grounded	SPST	NO	F-Bracket	Silver 5/16"-24	10-32 stud	3	
24512-03	—	—		12	—	200	300	Insulated	SPST	NO	L-Bracket	Copper 5/16"-24	Blade	2	
24612-03	24612-03-BX	—		12	—	200	300	Insulated	SPST	NO	L-Bracket	Copper 5/16"-24	10-32 studs	2	
24712-S7	—	—		12	—	200	500	Insulated	SPST	NO	F-Bracket	Copper 1/4"-20	8-32 studs	2	•
24612-G13	—	—		12	—	200	300	Grounded	SPST	NO	L-Bracket	Copper 5/16"-24	8-32 stud	3	
24712-GS7*	—	—		12	—	200	500	Grounded	SPST	NO	F-Bracket	Copper 1/4"-20	8-32 stud	3	•

*Special Order Item

Bi-Stable Latching Relays



HD Series • 300A General Purpose Bi-Stable Relays

- Very low current draw to maintain closed circuit
- Remotely-operated 300A disconnect for high-amperage circuits
- Small control wires: eliminates the cost and weight of routing large copper cables
- Bi-stable (latched) operation draws no current in On or Off: eliminates a continuous demand on batteries.
- LED output wire enables remote indication of relay status – Open or Closed.
- Silver alloy contactsw assure the lowest voltage drop / resistance and extends cycling life of the device.
- Stainless steel hardware and tin-plated copper contacts maximize resistance in harsh environments.

Download additional technical information at: littelfuse.com/HD-Relay

PART NUMBERS			VOLTAGE	AMPERAGE	INGRESS	NOTES
BULK	INDIVIDUAL BOX	RETAIL CLAMSHELL				
880086	880086S	–	12V DC	300A	IP66/IP69k	–
880088	–	–	24V DC	300A	IP66/IP69k	–

SD Series • 300-600A Bi-Stable Relay



An all-vehicle battery disconnect, designed to support remote power switching applications. Great for high continuous current passage, large engine starting needs and high ambient temperatures.

- Small control wires: eliminates the cost and weight of routing large copper cables to an accessible switch
- Dedicated 24-hour output, thermally protected, for tachograph or other keep-alive functions.
- Supports multiple Off switch control applications.
- Ignition protected to SAE J1171 and ISO 8846 for installation in battery box or with hazardous loads.
- Auxiliary relay contacts (normally open & normally closed) for Alternator Field Disconnect (AFD) or for additional vehicle system control

Download additional technical information at: littelfuse.com/SD-Relay

PART NUMBERS			VOLTAGE	AMPERAGE	CIRCUITRY	INGRESS	NOTES
BULK	INDIVIDUAL BOX	RETAIL CLAMSHELL					
880103	880103S	–	12V DC	600A	Single Pole	IP66/IP69k	4/0 input/output cables
880107	880107S	–	12V DC	300A	Dual Pole	IP66/IP69k	4/0 input/output cables



24200 • 110A Standard High Current Latching Solenoid

Requires only a momentary application of coil power to operate. Minimal heat is generated, because the coil is de-energized when the solenoid is On.

- Continuous Duty Style (Rated at 110A carry only)

Download additional technical information at: littelfuse.com/24200

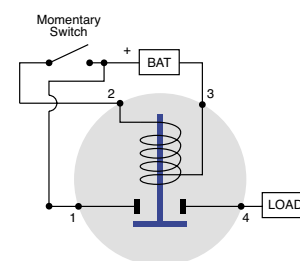

PART NUMBERS			VOLTAGE	AMPS	COIL TYPE	CIRCUITRY	FORM / CONTACTS	HOUSING MATERIAL	CONTACTS	TERMINALS
BULK	INDIVIDUAL BOX	RETAIL CLAMSHELL								
24200	24200-BX	24200-BP	12V DC	110A	Insulated	SPST	NO	Plated Steel	Copper 5/16"-24	Steel 10-32"

12-24V DC • 150A Motor Reversing Intermittent Duty Solenoid

A combination of two solenoids in one package to reduce cost and maximize space savings while also providing simpler wiring.

- 75A Make/Break: 5 min On, 5 min Off
- 125A Make/Break: 30 sec On, 5 min Off
- 150A Make/Break: 0.5 sec On, 5 min Off

Download additional technical information at: littelfuse.com/24450

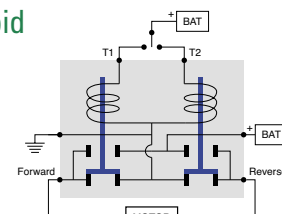

PART NUMBERS			VOLTAGE	AMPS	COIL TYPE	CIRCUITRY	CONTACTS	TERMINALS
BULK	INDIVIDUAL BOX	RETAIL CLAMSHELL						
24450	24450-BX	24450-BP	12V DC (14.5 max)	75-150A	Common Ground	DPDT	Copper	Two Blade Coil
24450-02	–	–	24V DC	75-150A	Common Ground	DPDT	Copper	Two Blade Coil

Plug-In Relays



Heavy Duty High Power and Micro Plug-In Relays

General purpose relays fit many vehicles and applications. Typical applications include: lighting, starting, horn, heating and cooling.

Standard ISO terminal footprint for Form A, Form C and Form 2A. Relays are available sealed and unsealed (unsealed 40 & 70A relays are supplied with snap-in brackets.)

Datasheet, wiring diagram, and additional information: littelfuse.com/Plug-In-Relays

Specifications

- Pull-in voltage: 7.8V maximum at 12V DC, 15.6 V at 24V DC
- Release voltage: 1.2 V minimum at 12V DC, 2.4 V at 24V DC
- Temperature range: -40°C to 85°C
- Operational life: Electrical to 100,000 cycles.
Mechanical to 10,000,000 cycles
- Contact Material: Silver alloy
- Dielectric strength: 500 V rms between coil and contact
- Insulation resistance: 100 MΩ minimum (500V DC)
- Relays are rated based on a steady state resistive load. De-rate according to the type of load.
Motor load: Inrush can be 5 to 10 x steady state current.
Solenoid load: Inrush can be 10 to 20 x steady state current.
Incandescent lamp load: Inrush can be 10 to 15 x steady state current.
- Available with PCB terminals, contact Littelfuse for details.

5

Heavy Duty Relays • 40A at 12V DC

- Contact rating (Resistive load) at 20°C:
12V DC: Normally Open 40A, Normally Closed 30A
24V DC: Normally Open 20A, Normally Closed 15A
- Contact arrangement: Available as Form A (SPST), Form C (SPDT) and Form 2A (SPST, 2 terminals)
- Vibration resistance: 10-40Hz double amplitude 1.5mm

High Power Relays • 70A at 12V DC

- Contact rating (Resistive load) at 20°C:
12V DC: Normally Open 70A, Normally Closed 60A
24V DC: Normally Open 35A, Normally Closed 30A
- Contact arrangement: Available as Form A (SPST) and Form C (SPDT)
- Vibration resistance: 10-40Hz double amplitude 1.5m

Micro Relays • 25A at 12V DC

- Contact rating (Resistive load) at 20°C:
12V DC: Normally Open 25A, Normally Closed 20A
24V DC: Normally Open 15A, Normally Closed 10A
- Contact arrangement: Available as Form A (SPST), and Form C (SPDT).
- Vibration resistance: 10-40Hz double amplitude 1.27mm

Part Numbering System

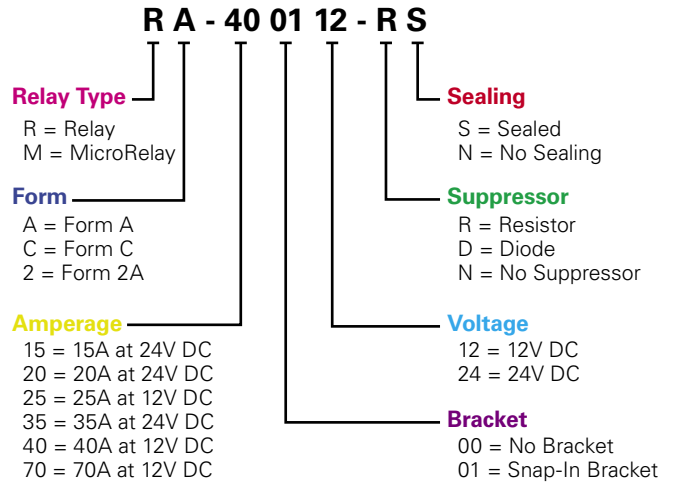

Relay Stock Items

PART NUMBERS		VOLTAGE	AMPS	RELAY TYPE	FORM	BRACKET	SUPPRESSOR TYPE	SEALED
BULK	BOX							
R2-200124-RN	-BX	24	20	Relay	2	SPST	• Resistor	
R2-400112-RN	-	12	40	Relay	2	SPST	• Resistor	
RA-200024-DS	-	24	20	Relay	A	SPST	• Diode	•
RA-200124-DN	-	24	20	Relay	A	SPST	• Diode	
RA-200124-NN	-	24	20	Relay	A	SPST	• None	
RA-200124-RN	-	24	20	Relay	A	SPST	• Resistor	
RA-400012-DS*	-	12	40	Relay	A	SPST	• Diode	•
RA-400112-DN	-BX	12	40	Relay	A	SPST	• Diode	
RA-400112-NN	-BX	12	40	Relay	A	SPST	• None	
RA-400112-RN	-BX	12	40	Relay	A	SPST	• Resistor	
RA-700112-DN	-BX	12	70	Relay	A	SPST	• Diode	
RA-700112-NN	-BX	12	70	Relay	A	SPST	• None	
RA-700112-RN	-BX	12	70	Relay	A	SPST	• Resistor	
RC-200024-DS*	-	24	20	Relay	C	SPDT	• Diode	•
RC-200124-DN	-BX	24	20	Relay	C	SPDT	• Diode	
RC-200124-NN	-BX	24	20	Relay	C	SPDT	• None	
RC-200124-RN	-BX	24	20	Relay	C	SPDT	• Resistor	
RC-400012-DS	-BX	12	40	Relay	C	SPDT	• Diode	•
RC-400112-DN	-BX	12	40	Relay	C	SPDT	• Diode	
RC-400112-NN	-BX	12	40	Relay	C	SPDT	• None	
RC-400112-RN	-BX	12	40	Relay	C	SPDT	• Resistor	
RC-700112-DN	-BX	12	70	Relay	C	SPDT	• Diode	
RC-700112-NN	-BX	12	70	Relay	C	SPDT	• None	
RC-700112-RN	-BX	12	70	Relay	C	SPDT	• Resistor	
MA-150024-NN	-	24	15	MicroRelay	C	SPDT	• None	
MC-150024-RN	-	24	15	MicroRelay	C	SPDT	• Resistor	
MC-250012-DN*	-	12	25	MicroRelay	C	SPDT	• Diode	
MC-250012-NN	-	12	25	MicroRelay	C	SPDT	• None	
MC-250012-RN	-	12	25	MicroRelay	C	SPDT	• Resistor	
MC-250012-RS	-	12	25	MicroRelay	C	SPDT	• Resistor	•

*Special Order Item



Modular Relay Sockets • Bi-Stable Relay

Accepts Littelfuse brand relays and standard ISO relays.

- Modular – sockets dovetail together
- Accepts standard quick-connect terminals
- Easy mount bracket
- Constructed of rugged glass-filled polyamide
- Temperature range: -40°C to 85°C

PART NUMBERS			RELAY TYPE		FORM	NOTES
BULK	INDIVIDUAL BOX	RETAIL CLAMSHELL	AMPERAGE	TERMINAL WIDTH		
99025	99025-BX	–	70A	.375"	A	Use with Tyco (AMP) terminals 280756 or 280755 (consult terminal manufacturers for full specs)
99026	99026-BX	–	40A	.250"	A or C	Use with Tyco (AMP) terminals 42281 or Ark-Les 3000H112A series (consult terminal manufacturers for full specs)

70A • Forward & Reverse Relay Module

Ideal for tarp or lift applications. Also use on hoists, hatches, winches, snowplows, intake/exhaust fans, vehicle outriggers and other reversing applications. Module automatically reverses the direction of the motor when the appropriate control circuit is energized with a pulse from a control switch. Dynamic braking stops the motor when the switch returns to Off.

- Dimensions: 2.91" x 3.51" x 1.86" H (73.9 x 91.7 x 47.2mm)
- Placeholder

Download additional technical information at: littelfuse.com/24450



5

PART NUMBERS			VOLTAGE	AMPERAGE		INRUSH	SEALING	CONTACTS
BULK	INDIVIDUAL BOX	RETAIL CLAMSHELL		INTERMITTENT	CONTINUOUS			
24452	24452-BX	–	12V DC	70A (On: 5 min max, Off: 3 min)	50A	150A	IP67	Silver

Plug-In Relay & MicroRelay Schematics and Terminal Layout

General purpose relays fit many vehicles and applications.

FORM	RELAY SCHEMATICS	RELAY TERMINAL LAYOUTS (40A .250" terminals – 70A .375" terminals)	MICRORELAY TERMINAL LAYOUTS
Form A			
Form C			
Form 2			– Not Available –

Battery & Master Disconnect Switches



Master Disconnect Switches are available for any application and suitable for 12V to 48V and up to 500A continuous (at 12V). Other features include: single or dual pole configurations, stem or flange mount, with lockout/tagout and lever or keyed actuators.



Lockouts & Tagouts

Lockouts and tagouts prevent operators, technicians and maintenance personnel from unanticipated power-ups that might cause injury or death.



According to OSHA, "A lockout device utilizes a positive means such as a lock to hold an energy isolating device in a safe position and prevent the energization of a machine." A tagout is a tag or seal that states 'Do not operate or remove this tag' and is signed by the person who places the tagout. Procedures specify that nobody but that person may remove the tag.

A lockout on a battery switch not only keeps a vehicle safe, but also immobilizes it. A locked out vehicle is less vulnerable to battery drain or theft.

Battery Disconnect Switches



75920 • 400A Sealed Master Disconnect Switch

Protects vehicles against tampering, theft and battery drain. Switch protects from hazards during vehicle servicing and provides an effective emergency power cutoff. Can be used in both positive or in negative path applications. Built-in lockout satisfies OSHA requirements for an energy isolation device.

- 400A continuous at 12V DC — 3000A intermittent at 12V DC (15sec on 5 min off)
- Waterproof and dustproof to IP68 - switch can be mounted in exposed locations
- Built-in lockout satisfies OSHA requirements for an energy isolation device
- Large red knob is easy to operate with gloves
- Large divider on base prevents accidental shorting of high energy cables

For datasheet, wiring diagram, and additional pack sizes visit: littelfuse.com/75920

PART NUMBERS			VOLTAGE	AMPERAGE	CIRCUITRY	MOUNTING TYPE	INGRESS	NOTES
BULK	INDIVIDUAL BOX	RETAIL CLAMSHELL						
75920	75920-BX	75920-BP	12-36V DC	200-400A	SPST	Through-Hole	IP68	Bezel marked "off - on"
75920-05	75920-05-BX	—	12-36V DC	200-400A	SPST	Through-Hole	IP68	Bezel marked "O - I" symbols
75920-10	75920-10-BX	—	12-36V DC	200-400A	SPST	Through-Hole	IP68	Stainless Steel Hardware
75921	—	—	12-36V DC	200-400A	SPST	Through-Hole	IP68	Metric Hardware
75921-10	—	—	12-36V DC	200-400A	SPST	Through-Hole	IP68	Stainless Steel Metric Hardware



TR • 500A Dual Pole Master Disconnect Switch

Cuts all battery power from vehicle electrical system, or for applications needing switching of two circuits, or both positive and negative.

- 500A continuous current rating for each of the two circuits (using 2 x 4/0 input and 2 x 4/0 output cables)
- Can be used to switch two vehicle voltage circuit simultaneously (12 & 24V DC)
- Built-in lockout satisfies OSHA requirements for an energy isolation device
- Ignition protected to SAE J1171 and ISO8846 for installation in a battery box or on vehicles carrying hazardous loads
- Ingress protection to IP67 and IP69k means that the switch can be mounted in exposed locations.

For datasheet, wiring diagram, and additional pack sizes visit: littelfuse.com/TR

PART NUMBERS			VOLTAGE	AMPERAGE	CIRCUITRY	MOUNTING METHOD	INGRESS	NOTES
BULK	INDIVIDUAL BOX	RETAIL CLAMSHELL						
880175	880175S	—	12-24V DC	500A	DPST	Flange Mount	IP67 & IP69K	—



SR • 300A Flange Mount Master Disconnect Switches

Isolates high current DC circuits from battery sources. Available in multiple case designs with optional padlock capability.

- 300A continuous current rating
- Tin-plated copper studs provide maximum conductivity and lower contact resistance.
- Stainless steel hardware provides superior corrosion resistance.
- Ignition protected to SAE J1171 and ISO8846 for installation in a battery box or on vehicles carrying hazardous loads.

For datasheet, wiring diagram, and additional pack sizes visit: littelfuse.com/SR

PART NUMBERS			MAX VOLTAGE	AMPERAGE (AT 12V DC)	CRANKING RATING (12V DC, 30sec)	INGRESS	NOTES
BULK	INDIVIDUAL BOX	RETAIL CLAMSHELL					
880062	880062S	—	48V DC	300A	1250A (1 x 4/0 cable)	IP67 & IP69K	Panel Mount
880064	880064S	—	48V DC	300A	1250A (1 x 4/0 cable)	IP67 & IP69K	Panel Mount with Lock-Out
880154	880154S	—	36V DC	600A	2500A (1 x 4/0 cable)	IP67 & IP69K	High Cranking Panel Mount with Lock-Out

Standard Battery Disconnect Switches



Metal Body Master Disconnect Switches - Single Pole (SPST)

Designed to disconnect the battery circuit on 6-36V DC systems. Two positions: Off-On.

- Mounting Stem: Brass, 3/4" -16 thread with one of three lengths:
 - 23/32" (18.3mm) long, fits panels up to 3/16" (4.8mm) thick
 - 17/32" (13.5mm) long, fits panels up to 1/4" (6.4mm) thick
 - 1 13/32" (46.1mm) long, fits panels up to 15/16" (23.8mm) thick
- Torque: Mounting Stem 20 ft/lb max - 3/8" nuts 70-90 in/lbs
- M-284-09BP includes Faceplate
- Electrical ratings on UL labels are conservative

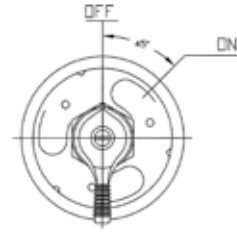

2-position lever model shown

For datasheet, wiring diagram, and additional pack sizes visit: littelfuse.com/2484



2484 with steel case and diecast lever



M-248-01 with brass case and diecast lever



2484-03 with steel case and Hencol lock



75908

6

PART NUMBERS			VOLTAGE	AMPS		CASE	TERMINAL STUDS	MOUNTING STEM		ACTUATOR	CONTACTS	INDEXING PIN	O-RING SEAL	SEALED TERMINAL INSULATION	UL LISTED			
BULK	INDIVIDUAL BOX	RETAIL CLAMSHELL		CONTINUOUS	INTERMITTENT			MATERIAL	SIZE									
2484	-BX	-	6	40	250	Plated Steel	Two 3/8"-24	Brass	23/32 long	Lever	Copper				•			
2484-16	-BX	-	12	20	125						Silver				•			
2484-A	-BX	-	6-36	175	800 (15s On-5m Off)						Silver							
2484-06	-BX	-									Silver	•	•					
2484-09	-BX	-									Copper							
2484-02	-BX	-								17/32 long	Hencol Lock	Silver	•					
2484-03	-BX	-										Silver	•	•				
2484-19	-BX	-	6-24	-	1000 (30s On-5m Off)								Silver	•	•	•		
M-284	-BX	-BP	6-36	175	1000 (15s On-5m Off)				Brass	Two 3/8" (9.5mm Ø)	Brass	1 13/32" long	Lever	Copper				
M-284-A	-BX	-				Lever												
M-284-01	-BX	-BP				Lever	Silver								•			
M-284-02	-BX	-				Dichromate Lever		•					•					
M-284-09*	-	M-284-09BP*				Dichromate Lever		•					•					
75908	-BX	-	12	300	2000 (30s On-3m Off)	Plated Steel	Two 1/2"-20	-	17/32 long	Lever	Copper			•				

Dimensions (for reference only)

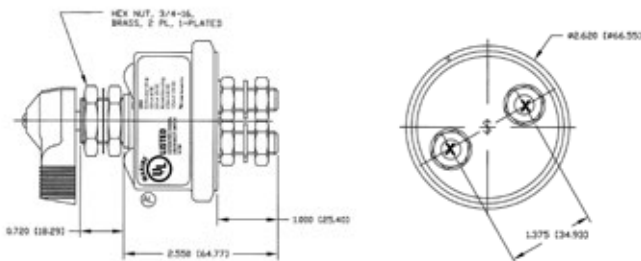

SPST Wiring Diagram

Download instruction form IF-126 from littelfuse.com

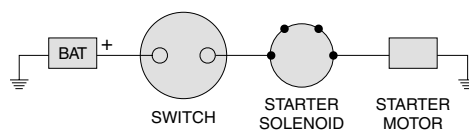



Metal Body Master Disconnect Switches - Double Pole (DPST)

Designed to disconnect the battery circuit and the alternator or generator field circuit on 6-36V DC systems. Two positions: Off-On.

- Mounting Stem: Brass, 3/4" -16 thread with one of three lengths:
 - 23/32" (18.3mm) long, fits panels up to 3/16" (4.8mm) thick
 - 17/32" (13.5mm) long, fits panels up to 1/4" (6.4mm) thick
 - 1 13/32" (46.1mm) long, fits panels up to 15/16" (23.8mm) thick
- Torque: Mounting Stem 20 ft/lb max - 3/8" nuts 70-90 in-lbs
- M-290-05 is UL Listed to 707B

For datasheet, wiring diagram, and additional pack sizes visit: littelfuse.com/7590X



PART NUMBERS			VOLTAGE	AMPS			CASE	TERMINAL STUDS	MOUNTING STEM		ACTUATOR	CONTACTS	INDEXING PIN	O-RING SEAL	SEALED TERMINAL INSULATION	UL LISTED
BULK	INDIVIDUAL BOX	RETAIL CLAMSHELL		LARGE STUDS		SMALL STUDS			MATERIAL	SIZE						
				CONTINUOUS	INTERMITTENT	CONTINUOUS										
75903	-BX	-	6-36	125	1000 (15s On-5m Off)	20	Plated Steel	Two 3/8"-24 & Two 10-32	Brass	3/4-16 23/32 long	Lever	Brass				
75904	-BX	-										Silver				
75904-01	-BX	-										Silver	•	•	•	
75904-02	-	-										Silver	•			
75904-03	-BX	-										Silver	•	•		
M-290	-	-	6-36	125	1000 (15s On-5m Off)	20	Brass	Two 3/8"-24 & Two 10-32	Brass	3/4-16 1 13/32" long	Lever	Silver				
M-290-01	-BX	-										Silver		•		
M-290-05	-BX	-										Silver				•
75907	-BX	-	6-36	300	2000 (30s On-3m Off)	20	Plated Steel	Two 1/2"-20 & Two 10-32	-	3/4-16 23/32 long	Lever	Copper	•		•	
75912	-BX	-	6-36	125	750 (15s On-5m Off)	-	Plated Steel	Four 3/8-24	-	3/4-16	Lever	Silver	•	•	•	

Note: 75912 has an epoxy seal at case, mounting stem and locating pin. The switch includes lockwasher and 2 brass hex nuts per stud. Operating Temperature Range: -40° to 85°F Mounting Torque: 20 ft-lbs (27 Nm) Stud Torque: 4.4-7.4 ft-lbs (6-10 Nm)

DPST Wiring Diagram

Download instruction form IF-109 from littelfuse.com

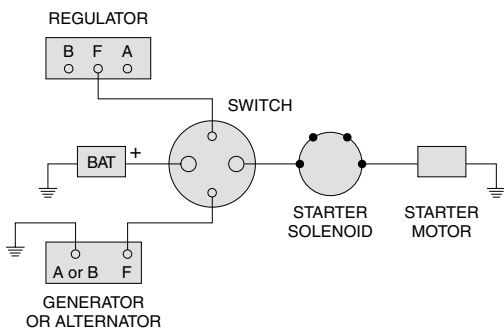

75912 Wiring Diagram

For two high current loads

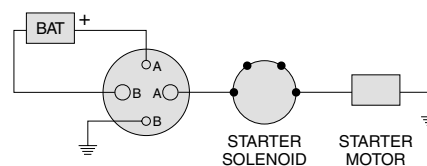

Battery Selector Disconnect Switches



M-750 • Dual Battery Selector / Master Disconnect Switch

For any vehicle that needs to use two batteries where one battery is used for starting the engine, while the other is used to power auxiliary loads. This is a common situation in trucks, boats, RVs, police and rescue vehicles, and in ambulances and fire equipment.

A selector switch allows use of the first battery, the second battery, or both batteries simultaneously. This provides back-up starting power in an emergency. Either or both batteries can be selected to supply power.

These switches combine the functions of Battery Selector and Master Disconnect Switches to give four battery power options:

- Power cut off at the source.
- Power On, Battery 1.
- Power On, Battery 2.
- Power On, both Batteries.

Electrical Ratings

Labeled UL 707B. Rating: 500A intermittent, 310A continuous, 6-36V DC
 Electrical ratings on UL labels are conservative. Use with either alternators or generators. Make before break design permits operation through the three On positions with the engines running. Engines should always be shut down before turning to Off. Wiring instructions are included.

Heavy-Duty Construction

- Vaporproof, weather, dust- and corrosion-resistant.
- Durable, fracture-resistant high temperature plastic case, knob and insulator.
- Switches conform to USCG section 183.410 for ignition protection. Resistant to impact, and temperature extremes.
- Heavy duty copper stud terminals, with brass hexnuts. Can be surface mounted, or installed through a 3 5/16" diameter hole in the panel
- Dimensions: Flange: 6" (152.4mm) diameter, overall height 2 5/8" (66.7mm).
 Terminals: 3 copper studs, 3/8" (9.5mm) diameter.
- Alternator field disconnect circuit switch. Prevents possible alternator diode failure if the switch is accidentally turned to Off with the engines running.

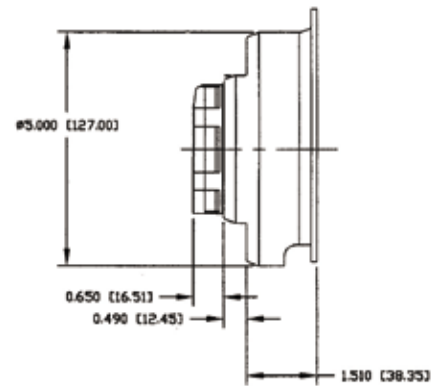
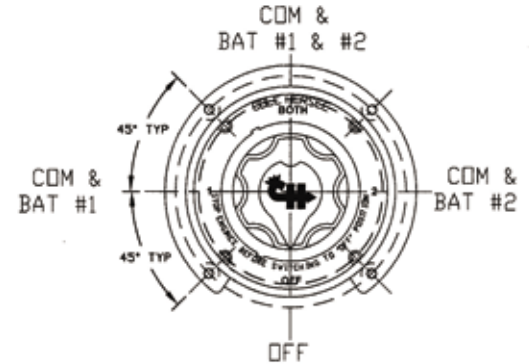

For datasheet, wiring diagram, and additional pack sizes visit: littelfuse.com/M750

6



M-750 Standard Switch



M-753 With Keyed Lock



M-754 Back

M-754 Back is shown. Three small terminals in the middle are for connection to the pilot light circuit. M-754-01, M-755 and M-755-01 are similar. M-752 and M-753 have two small terminals in the middle marked F1 and F2 for connection to the Alternator Field Disconnect circuit. M-750 and M-751 have no small terminals in the middle. Full wiring instructions are included.

PART NUMBERS			VOLTAGE	AMPERAGE	TERMINALS	MOUNTING TYPE	INGRESS	CERTIFICATION	LOCK	ALTERNATOR FIELD DISCONNECT	PILOT CIRCUIT
BULK	INDIVIDUAL BOX	RETAIL CLAMSHELL									
M-750	-	M-750-BP	6-36V DC	500A intermittent 310A continuous	Copper Stud 3/8" (9.5mm) Brass hexnuts	Surface Mount Panel Mount (3 5/16" Ø hole)	Vaporproof, Weather-Resistant, Dust-Resistant, and Corrosion-Resistant	UL 707B			
M-752*	-	-								•	
M-753*	-	-							•	•	
M-754	-	-BP									•
563	-	-	Switch position label for M-750 - Useful when switch is mounted through a panel								

*Special Order Item

Metal Body Master Disconnect Switches - Accessories

Replacement levers, faceplates, terminal caps and lockout kits for Battery Disconnect Switches.



24505 - Lockout lever kit



80101-B - Lever



83353 - Hencol Key



82065 - Faceplate with On-Off Marking



82065-03 - Faceplate with I-O Marking

PART NUMBERS			DESCRIPTION	DESCRIPTION
BULK	BOX	RETAIL		
24505	-BX	-	Lockout Lever Kit	Lever and flange plate accept a padlock to securely lock a Disconnect Switch in the Off position. For use with lever actuated switches with a 3/4" Ø diameter mounting stem. Use a padlock with a 5/16" Ø shackle
80101-B	-BX	-	Lever	Replacement chrome-plated diecast lever
83353	-BX	-	Hencol Key	Replacement Hencol Key - Heavy gauge plated steel resists corrosion
82065	-BX	-BP	Faceplate	Polished aluminum with enamel finish - 2 1/2" (63.5mm) Ø
82065-02	-BX	-	Faceplate	With indexing hole - Polished aluminum with enamel finish - 2 1/2" (63.5mm) Ø
82065-03*	-	-	Faceplate	International I-O markings - Polished aluminum with enamel finish - 2 1/2" (63.5mm) Ø
09230025LXRED	-	-	Red Cap	Fits M12 nuts on TR & 75921 series switches
09230025LXBLK	-	-	Black Cap	Fits M12 nuts on TR & 75921 series switches
09230025LXREDM8	-	-	Red Cap	Fits 3/8" & M10 nuts on SR & 75920 series switches
09230025LXBLKM8	-	-	Black Cap	Fits 3/8" & M10 nuts on SR & 75920 series switches

Battery Jumper Terminals and Feeder Studs

Battery Jumper Terminals are used to make easily-accessible battery connections, inside or outside the vehicle. They can be used individually or in pairs and are easy to install. Featuring solid brass posts, including a brass hexnut and lockwasher.

Feeder Studs bring power through bulkheads or firewalls and feature an impact-resistant plastic insulator/mounting bushing.



46210-02



46210-03



46211-R



46211-01

PART NUMBERS		VOLTAGE	DESCRIPTION	COLOR	TERMINAL/STUD SIZE	DIMENSIONS	NOTES
BULK	BOX						
46210-02	-BX	6-48V DC	Terminal Post	Red	Terminal: 13/16" (20.6mm) Ø 1-1/8" (29.9mm) long	-	Replacement Cap: 97846-A
46210-03	-BX	6-48V DC	Terminal Post	Black	Terminal: 13/16" (20.6mm) Ø 1-1/8" (29.9mm) long	-	Replacement Cap: 97846-B
46211-R	-BX	6-36V DC	Feeder Stud	Red	Two 3/8" -16 threads 5/8" (15.9mm) long	1 17/64" (32.1mm) Ø 5/8" (15.9mm) long	
46211-01	-BX	6-36V DC	Feeder Stud	Black	Two 3/8" -16 threads 5/8" (15.9mm) long	1 17/64" (32.1mm) Ø 5/8" (15.9mm) long	



JBPT Single Stud Junction Blocks

Connection points for distribution of power in feed-thru and non-feed-thru styles. Simplifies cabling and serves as convenient tap points. Stainless steel studs of various threads and sizes, in red or black thermoplastic body. 3/8" zinc-plated steel studs have electrical rating of 400A and low resistance due to large contact area. High installation torque values allow the use of large cable sizes for high current applications.

PART NUMBERS			COLOR	FEED TYPE	STUD SIZE	MOUNTING BASE
BULK	BOX	RETAIL				
JBPT2P01ZXR	-	-	Red	Feed-Thru	1/2"-13	69.8 x 47.6mm
JBPT2N02ZXB	-	-	Black	Non-Feed-Thru	1/2"-13	69.8 x 47.6mm
JBPT2N03ZXB	-	-	Black	Non-Feed-Thru	5/16"-18	69.8 x 47.6mm
JBPT3P01ZXB	-	-	Black	Feed-Thru	3/8"-18	52.4 x 19.1mm
JBPT3P02ZXB	-	-	Black	Non-Feed-Thru	3/8"-18	52.4 x 19.1mm
JBPT3N03ZXB	-	-	Black	Feed-Thru	3/8"-18	-
JBPT3N03ZXR	-	-	Red	-	3/8"-18	52.4 x 19.1mm
JBPT4P01ZXB	-	-	Black	-	1/4"-20	52.4 x 19.1mm
JBPT0001Z	-	-	Red	Feed-Thru	-	-

*Special Order Item

Ignition Switches



Littelfuse offers the broadest range of 12V to 48V Ignition Switches available which are suitable for any application. Variations include those with plastic or traditional metal body, lever-actuated, tumbler keyed, or patented Hencol keyed.

Anti-Restart

Several ignition switches, including the 95060 series, feature an anti-restart mechanism. An operator can damage the starter motor if the ignition switch is inadvertently turned the when the engine is running. This can happen in noisy environments where it may be difficult to hear the engine. The switch must be turned to the Off position before the start circuit can be re-energized.

95060 – Not Just for Ignitions

The 95060 series is widely used in ignition systems, There are many other applications including those in which a water-resistant keyed rotary switch for 12V, 24V or 36V, with two, three or four positions is required. Switches are also offered with a lever or soft knob actuator.



Sealed Ignition Switches

95060 Series • Sealed Ignition & Key Switches

Durable engineering thermoplastic construction withstands mechanical impact, and will not corrode, even on continual exposure to road salt. 95060 Switches have integral Deutsch-type connector for easy installs.

- Range of Voltages: 10A at 12V DC, 5A at 24V DC, 3A at 36V DC and 2A at 48V DC
- Options: key boot, anti-restart, or spring return
- Sealing: contacts are sealed front and back to IP67 standard, with connector installed
- Ignition Protection: Tested to SAE J259 for ignition switches and UL-Recognized
- Switches are available keyed alike or with multiple key codes. Key is removable only at the Off position
- Deutsch connectors & Wires Part Number: 31101 (included in -50, -51 and -60 items)

2D Prints and additional information: littelfuse.com/95060



PART NUMBERS			TOTAL	POSITIONS				ACTUATOR	KEYS					NOTES
BULK	INDIVIDUAL BOX	RETAIL CLAMSHELL		1	2	3	4		CODE	BOOT	HARNESS	SPRING RETURN	ANTI-RESTART	
95060	95060-BX	-	4	Acc	Off	Ign/Acc	Ign/Start	Keys		•		•		
95060-01	95060-01-BX	-		Acc	Off	Ign/Acc	Ign/Start	Keys		•		•	•	
95060-02	-	-		Acc	Off	Ign/Acc	Ign/Start	Keys		•				
95060-23	95060-23-BX	-		Acc	Off	Ign/Acc	Ign/Start	Keys	Single Code 601			•		
95060-51	-	-		Acc	Off	Ign/Acc	Ign/Start	Keys	Single Code 601			•	•	Same as 95060-23
95060-34	-	-		Acc	Off	Ign/Acc	Ign/Start	Keys	10 key code				•	
95060-50	-	95060-50-BP		Acc	Off	Ign/Acc	Ign/Start	Keys	10 key code	•	•	•		Same as 95060
95061	95061-BX	-		Acc	Off	Ign/Acc	Ign/Start	Lever					•	
95061-50	95061-50-BX	-		Acc	Off	Ign/Acc	Ign/Start	Lever			•	•		Same as 95061
95061-01*	-	-		Acc	Off	Ign/Acc	Ign/Start	Lever					•	•
95062-10*	-	-	Acc	Off	Ign/Acc	Ign/Start	Soft Knob					•		
95062-50*	-	-	Acc	Off	Ign/Acc	Ign/Start	Soft Knob			•	•		Same as 95062-10	
95060-03	95060-03-BX	-	3	Off	Ign/Acc	Ign/Start	-	Keys		•		•		
95060-60	-	95060-60-BP		Off	Ign/Acc	Ign/Start	-	Keys		•	•	•		Same as 95060-03
95060-04	95060-04-BX	-		Off	Ign/Acc	Ign/Start	-	Keys		•		•	•	
95060-05	95060-05-BX	-		Off	Ign/Acc	Ign/Start	-	Keys		•				
95060-06	95060-06-BX	-		Acc	Off	Ign	-	Keys		•				
95060-21*	-	-		Off	Ign/Acc	Ign/Start	-	Keys	10 key code	•		•		
95060-26*	-	-		Off	Ign/Acc	Ign/Start	-	Keys	Single code 601	•		•		
95060-36*	-	-		Mom On 1	Off	Mom On 2	-	Keys	Single code				•	
95060-43*	-	-		Mom On 1	Off	Mom On 2	-	Keys		•		•		
95061-04	95061-04-BX	-		Off	Ign/Acc	Ign/Start	-	Lever					•	•
95061-60	-	-	Off	Ign/Acc	Ign/Start	-	Lever			•	•	•	Same as 95061-04	
95061-36	95061-36-BX	-	Mom On 1	Off	Mom On 2	-	Lever					•		
95062-13	95062-13-BX	-	Off	Ign/Acc	Ign/Start	-	Soft Knob					•		
95062-53	-	-	Off	Ign/Acc	Ign/Start	-	Soft Knob			•	•		Same as 95062-13	
95060-07	95060-07-BX	-	2	Off	Ign/Acc	-	-	Keys		•				
95060-29	-	-		Off	Ign/Acc	-	-	Keys	Single code 601	•				
95061-07	-	-		Off	Ign/Acc	-	-	Lever						
95062-17	-	-		Off	Ign/Start	-	-	Soft Knob						
95062-57	-	-		Off	Ign/Start	-	-	Soft Knob			•			Same as 95062-17

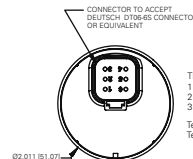
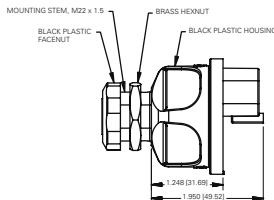
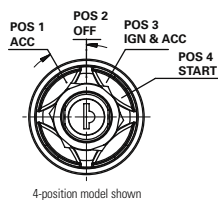

TERMINALS
 1 = Battery
 2 = Start
 3 = Accessory
 4 = Ignition
 5 = Ignition
 6 = Battery
 Terminals 1 and 6 are connected internally.
 Terminals 4 and 5 are connected internally.

*Special Order Item

Heavy Duty Ignition Switches



956 Series • Heavy Duty General Purpose Metal Body Ignition Switches

Dependable diecast zinc housing switches with an array of options for every application. Switches mount through the panel and have lever action or are keyed (hencol key or coded tumbler lock).

- Terminals: Brass blade 1/4" (6.4mm) wide accept Delphi (Packard) connector 2962912 or equivalent Screw Terminals include lock washers
 - Mounting: 1"-24 bushings fit panels .030" - .090" (.76mm - 2.3mm)
3/4"-24 bushings fit panels .060" - .110" (1.5mm - 2.7mm)
 - Key removable at Off positions on keyed switches
- 2D Prints and additional information: littelfuse.com/IgnitionSwitches

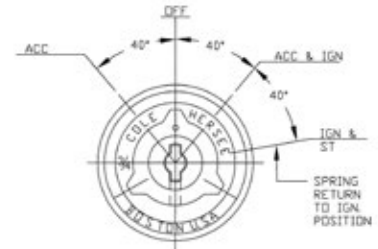

4-position model shown



Coded tumbler lock with 2 keys



Patented Hencol lock with 2 keys (83357)



Short handle lever (81254)

PART NUMBERS			AMP RATING (12V DC)				POSITIONS				ACTUATOR	TERMINALS	SPRING RETURN	ANTI-RESTART	GROUND TERMINAL	SILVER CONTACTS	SEAL TYPE			BUSHING SIZE			
BULK	BOXED	RETAIL	ACC	IGN	START	GROUND	TOTAL	1	2	3							4	TERMINALS	SPRING RETURN		ANTI-RESTART	GROUND TERMINAL	SILVER CONTACTS
956-4100	956-4100-BX	-	10	10	5	1	4	Acc	Off	Ign/Acc	Ign/Start	Coded key	4 blade	•				•			1"-24		
956-4104	956-4104-BX	-	10	10	5	1		Acc	Off	Ign/Acc	Ign/Start	Coded key	4 screw	•					•			1"-24	
956-4107	956-4107-BX	-	10	10	5	1		Acc	Off	Ign/Acc	Ign/Start	Hencol key	4 screw	•					•			1"-24	
956-4111	956-4111-BX	-	10	10	5	1		Acc	Off	Ign/Acc	Ign/Start	Short Lever	4 blade	•								1"-24	
956-4113*	-	-	30	10	5	-		Acc	Off	Ign/Acc	Ign/Start	Coded key	4 blade	•						•			1"-24
956-4116	-	-	30	10	10	-		Acc	Off	Ign/Acc	Ign/Start	Coded key	4 blade	•						•	•		1"-24
956-4124	956-4124-BX	-	10	10	5	1		Acc	Off	Ign/Acc	Ign/Start	Short Lever	4 screw	•						•	•		1"-24
956-4138*	956-4138-BX	-	30	20	10	-		Acc	Off	Ign/Acc	Ign/Start	Coded key	4 blade	•									1"-24
956-4141	956-4141-BX	-	30	20	10	-		Acc	Off	Ign/Acc	Ign/Start	Hencol key	4 screw	•					•			•	1"-24
956-4154	956-4154-BX	-	10	10	5	1		Acc	Off	Ign/Acc	Ign/Start	Coded key	5 screw	•		•							1"-24
956-4307	956-4307-BX	-	10	10	5	1	Acc	Off	Ign/Acc	Ign/Start	Hencol key	4 screw	•						•			3/4"-24	
956-4311	956-4311-BX	-	10	10	5	1	Acc	Off	Ign/Acc	Ign/Start	Coded key	4 blade	•								•	3/4"-24	
956-9100	956-9100-BX	-	10	5	5	-	Fuel	Off	Ign/Acc	Ign/Start	Hencol key	5 screw	•							•	•	1"-24	
956-3122	956-3122-BX	-	10	10	5	-	3	Off	Ign/Acc	Ign/Start	-	Coded key	5 screw	•	•	•			•	•	•	1"-24	
956-3124	956-3124-BX	-	10	10	5	-		Off	Ign/Acc	Ign/Start	-	Short Lever	5 screw	•	•	•						•	1"-24
956-3125	956-3125-BX	-	30	10	10	-		Off	Ign/Acc	Ign/Start	-	Coded key	4 screw	•	•							•	1"-24
956-3126	956-3126-BX	-	10	10	5	-		Off	Ign/Acc	Ign/Start	-	Hencol key	4 screw	•	•							•	1"-24
956-3127	956-3127-BX	-	30	10	10	-		Off	Ign/Acc	Ign/Start	-	Short Lever	3 screw	•	•							•	1"-24
956-5109	956-5109-BX	-	20	10	10	-		Off	Ign/Acc	Ign/Start	-	Military Lever	4 screw	•			•					•	1"-24
956-5122	-	-	20	20	10	-		Off	Ign/Acc	Ign/Start	-	Coded key	5 screw	•		•						•	1"-24
956-5124*	-	-	10	10	5	-		Off	Ign/Acc	Ign/Start	-	Hencol key	4 screw	•								•	3/4"-24
956-5307	956-5307-BX	-	10	10	5	1		Acc	Off	Ign/Acc	-	Hencol key	3 screw	•								•	3/4"-24
956-6107	-	-	10	10	-	-		Acc	Off	Ign/Acc	-	Hencol key	3 screw									•	1"-24
956-6307*	-	-	10	10	-	-	Acc	Off	Ign/Acc	-	Hencol key	3 screw									•	3/4"-24	
956-6310*	-	-	30	10	-	-	Acc	Off	Ign/Acc	-	Hencol key	3 screw	•								•	3/4"-24	

Typical Hencol Switch Dimensions

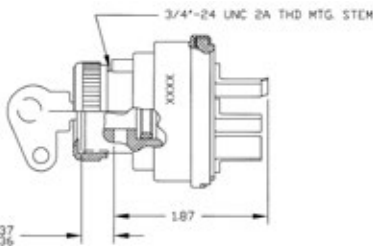

5 Screw Terminals

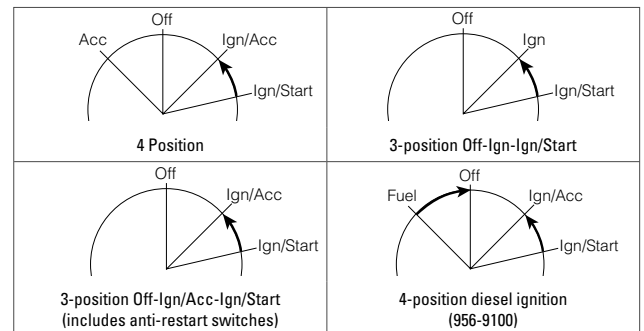

*Special Order Item

General Purpose Ignition Switches

95 Series • General Purpose Metal Body Ignition Switches

General purpose switches in zinc diecast or plated steel housings. Switches mount through the panel, have lever action or are keyed (hencol key or coded tumbler lock) and feature screw terminals with lock washers. Spring return to IGN or IGN/ACC on all switches
 †(except 9578). Key removable at Off positions on keyed switches (except 9518)

2D Prints and additional information: littelfuse.com/IgnitionSwitches

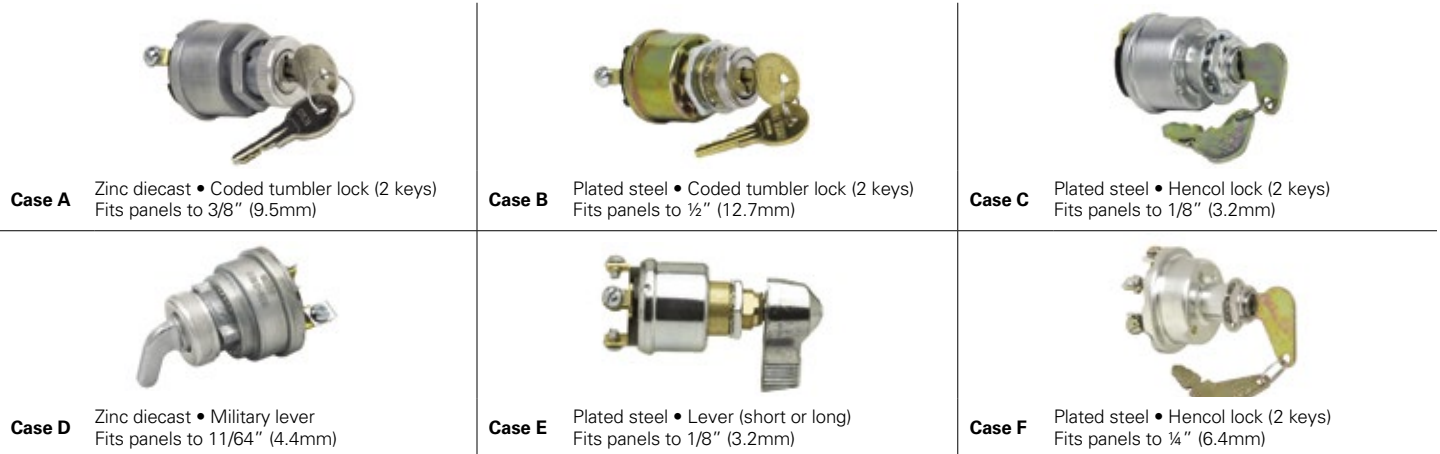

PART NUMBERS			AMP RATING (12V DC)				POSITIONS				ACTUATOR	TERMINALS	CASE STYLE	SILVER CONTACTS	O-RING SEAL	BUSHING SIZE	NOTES
BULK	BOXED	RETAIL	ACC	IGN	START	TOTAL	1	2	3	4							
9579	9579-BX	-BP	10	10	5	4	Acc	Off	Ign/Acc	Ign/Start	Coded lock	4 screw	A			3/4"-20	
9579-02	9579-02-BX	-	10	10	5	4	Acc	Off	Ign/Acc	Ign/Start	Coded lock	4 screw	A			3/4"-20	Single key code CH-505
95525-A	95525-A-BX	-	10	10	5	4	Acc	Off	Ign/Acc	Ign/Start	Hencol lock	4 screw	C		•	5/8"-32	
9513	9513-BX	-		10	5	3	Off	Ign	Ign/Start	-	Coded lock	3 screw	A			3/4"-20	
9578 [†]	9578-BX	-	10	10		3	Acc	Off	Ign/Acc	-	Coded lock	3 screw	A			3/4"-20	
95033	95033-BX	-		50	10	3	Glow	Off	Glow/Start	-	Lever	3 screw	E				50A Glow - Diesel Ignition
95521-01	95521-01-BX	-		25	70	3	Off	Ign	Ign/Acc	-	Lever	3 screw	E		•	5/8"-32	Dichromate Lever
95521-B	95521-B-BX	-		25	70	3	Off	Ign	Ign/Acc	-	Hencol lock	3 screw	F		•	5/8"-32	Long Hencol Key
95524-A	95524-A-BX	-		10	5	3	Off	Ign	Ign/Start	-	Hencol lock	3 screw	C		•	5/8"-32	
95526-A*	-	-		5		3	Off	Run	Start	-	Hencol lock	3 screw			•		Plated Steel Case
95534	95534-BX	-		10	5	3	Off	Ign	Ign/Start	-	Coded lock	3 screw	B			3/16"-24	
95539	95539-BX	-	10	1	5	3	Off	Run	Start	-	Coded lock	4 screw				3/4"-20	1A Magneto
95561-01	95561-01-BX	-		10	5	3	Off	Ign	Ign/Acc	-	Hencol lock	3 blade	F		•	5/8"-32	
95582	95582-BX	-		10	5	3	Off	Ign	Ign/Start	-	Coded lock	3 screw	A		•	3/4"-20	
95591	95591-BX	-		10	5	3	Off	Ign/Acc	Ign/Start	-	Long lever	4 screw	E		•	5/8"-32	
95610	95610-BX	-		25	20	3	Off	Ign	Ign/Acc	-	Lever	3 screw	E			5/8"-32	
95612	95612-BX	-		25	20	3	Off	Ign	Ign/Acc	-	Lever	3 screw	E		•	5/8"-32	
95613	95613-BX	-		20	20	3	Off	Ign	Ign/Acc	-	Lever	3 blade	E		•	5/8"-32	
95634-01	95634-01-BX	-		10	5	3	Off	Ign	Ign/Start	-	Military lever	3 screw	D		•	3/4"-20	
9518*	-	-	10			2	Off	On (Ign)	-	-	Coded lock	2 screw	A			3/4"-20	Key removable in both positions
9577	9577-BX	-	10			2	Off	On (Ign)	-	-	Coded lock	2 screw	A			3/4"-20	
9622-01	9622-01-BX	-	5			2	Off	On (Ign)	-	-	Coded lock	2 screw				3/4"-24	Compact - Stainless steel bezel & face washer - Key removable
95517-A	-	-		1A Run		2	Off	Run	-	-	Hencol lock	2 screw				5/8"-32	1A Magneto
95522-A	-	-	10			2	Off	On (Ign)	-	-	Hencol lock	2 screw	C		•	5/8"-32	
95532	95532-BX	-	10			2	Off	On (Ign)	-	-	Coded lock	2 screw	B			3/16"-24	
95597	95597-BX	-				2	Off	On (Ign)	-	-	Hencol lock	2 screw	F		•	5/8"-32	Long Hencol Key
95564-01	-	-	20			2	Off	Start	-	-	Hencol lock	2 blade	F		•	5/8"-32	
95633-A	95633-A-BX	-	10	10		2	Off	Ign/Acc	-	-	Military lever	3 screw	D			3/4"-20	Moisture- & fungus-resistant per MIL-JAN-T-152
M-288	M-288-BX	-				2	Off	On (Ign)	-	-	Lever	2 screw	F		•	5/8"-32	Marine-Grade

*Special Order Item

Special Purpose Ignition Switches



Delco Replacement Ignition and Start Switches

Replacement switches sold without a lock cylinder. To receive a new lock cylinder and 2 keys order part number 95874. Both part numbers feature a 1"-24 UNS-2A thread and key is only removable in Off position.

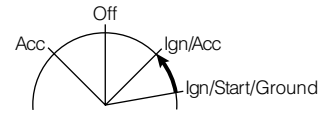

- 7 Blade Terminals accept Delphi (Packard) 6288702. Includes 2 ground terminals for checking indicator bulbs. 1 additional battery terminal provides continuous hotfeed for optional equipment.
- Replaces Delco D-1403-A, D-1406-A, D-1480, D-1498-A, • Chevrolet Trucks 67-83, 85-89, GMC 1116712, 1116683, 1116695, 1116704, 1116709, 1116711, 2234285 • GMC Trucks 67-83, 85-89

2D Prints and additional information: littelfuse.com/IgnitionSwitches

PART NUMBERS			POSITIONS				ACTUATOR	TERMINALS	SPRING RETURN	GROUND TERMINAL	O-RING
BULK	BOXED	RETAIL	1	2	3	4					
95410	95410-BX	-	Acc	Off	Ign/Acc	Ign/Start/Ground	None	7 screw	•	•	•



10A Compact Ignition Switch with Lever

Compact size ignition switch in a plated steel case. Electrical Ratings at 12V DC at 10A

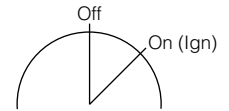

PART NUMBERS			RATING	POSITIONS	TERMINALS	MOUNTING STEM
BULK	BOXED	RETAIL				
9500	9500-BX	-	12V DC at 10A	2: Off - On/Ign	2 screw	½"-20 fits panels to 13/64" (5.2mm)

7



10A Reversing Switch with Tumbler Key

Reversing Switch in a plated steel case. Key is removable in Off position only with Spring return to Off. Electrical Ratings at 12V DC at 10A

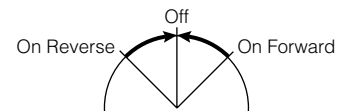

PART NUMBERS			RATING	POSITIONS	TERMINALS	MOUNTING STEM
BULK	BOXED	RETAIL				
75705-01	75705-01-BX	-	12V DC at 10A	3: Mom Forward - Off - Mom Reverse	3 screw	13/16"-24 Stem with O-ring Seal

*Special Order Item



5A 2-Position Ignition Switch

- Electrical ratings at 12V DC: 5A ignition
- Two brass screw terminals
- Key is removable only in the Off position
- Mounting stem fits panels up to 5/8" (15.9mm) thick

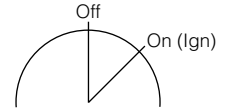

PART NUMBERS			POSITIONS		ACTUATOR	TERMINALS	MOUNTING STEM
BULK	BOXED	RETAIL	1	2			
M-676	M-676-BX	M-676-BP	Off	Ign	Key	2 screw	3/4"-27 Ø stem, 3/4" (19.1mm) long



15A Marine Design Ignition Switch

Durable plastic case and stem with PVC boot for added weather protection. Key is removable only in the Off position. Off-Run-Start Spring return to IGN.

- Electrical ratings at 6-36V DC: 15A ignition, 5A start
- Three nickel-silver screw terminals
- Mounting stem fits panels up to 7/8" (22.2mm) thick, with 7/8" diameter hole

PART NUMBERS			POSITIONS			ACTUATOR	TERMINALS	SPRING RETURN	MOUNTING STEM
BULK	BOXED	RETAIL	1	2	3				
M-850	M-850-BX	M-850-BP	Off	Run	Ign/Start	Key	3 screw	•	Fits panels to 7/8" (22.2mm) with 7/8" Ø hole

Ignition Switch Keys, Protective Boots, Caps, Facenuts and Cover Accessories



83357 - Hencol Key - Short



83353 - Hencol Key - Long



83373 & 83379 - Tumbler Key



83285-01 & 83288 - Protective Boot



8367 - Facenut



98635-01 - Key Cover

PART NUMBERS			DETAILS	MATERIAL	DESCRIPTION
BULK	BOX	RETAIL			
83357	83357-BX	-	Hencol Key	Heavy Gauge Steel Plated	Hencol S Short Key
83353	83353-BX	-	Hencol Key	Heavy Gauge Steel Plated	Hencol L Long Key
83373	83373-BX	-	Tumbler Blank	Brass	Designed for 956-XXX Series Switches
83379	83379-BX	-	Tumbler Blank	Brass	Design for 95 Series & M-XXX Marine Switches
83285-01	83285-01-BX	-	Protective Boot	Aluminum	Mounting nut containing a rubber self-closing key slot - 3/4"-20 threads 7/16" thick
83288	83288-BX	83288-BP	Protective Boot	Chrome-Plated Brass	Mounting nut containing a rubber self-closing key slot - 13/16"-24 thread 7/32" thick
8367	8367-BX	-	Facenut	Aluminum	Knurled Edges - 3/4"-20 thread 19/64" thick - Clears 5/8" Hole
98635-01	-	-	Key Cover	Plastic	Black Slip-On Cover for Tumbler Keys 83373 & 83379

Rocker Switches



Illumination Type: Dependent or Independent?

Dependent:

The actuator is illuminated only when the switch is turned on.

Independent:

Illumination is not affected by the actuation of the switch. The illumination can be switched on or off by another switch, such as headlight or interior lighting controls. This is especially useful when locating switches in the dark.

What does SPST or DPST mean?

The first two letters, SP or DP, refer to single pole or double pole. The second two letters, ST or DT refer to single throw or double throw.

Pole refers to the number of circuits controlled by the switch. SP switches control one circuit and DP switches control two independent circuits (which act like two identical switches that are mechanically linked). Pole is often confused with terminal, which is a common mistake. Terminals are used for wire connections on the back of the unit and are specified separately.

Throw refers to the extreme position of the actuator. ST switches close a circuit at only one position and the other position is off. DT switches close a circuit in the Up position, as well as the down position and can be configured with two positions (On-On) or three positions (On-Off-On).

Sealed Rocker Switches

25A LED Sealed Rocker Switches

- Weather-resistant with contact areas sealed to IP66 (high pressure wash resistant)
- Super-bright LED illumination and high-visibility wrap-around lenses
- LEDs give visibility, even in sunlight and have a long life
- Silver contacts and corrosion-resistant nickel-plated brass blades for superior performance and electrical contact

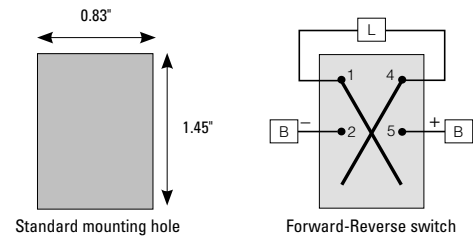

2D Prints and additional information: littelfuse.com/RockerSwitches



PART NUMBERS			RATING	POLE & THROW	ACTION	ILLUMINATION	LED PILOT LIGHTS		TERMINALS	CONTACTS	SEALING
BULK	INDIVIDUAL BOX	RETAIL CLAMSHELL					LENS COLOR 1	LENS COLOR 2			
58312-A2	58312-A2-BX	-	25A at 12V DC	SPST	On-Off	Independent	Amber	-	4 blade	Silver	IP66
58312-G2	58312-G2-BX	-	25A at 12V DC	SPST	On-Off	Independent	Green	-	4 blade	Silver	IP66
58312-R2	58312-R2-BX	-	25A at 12V DC	SPST	On-Off	Independent	Red	-	4 blade	Silver	IP66
58312-A4	58312-A4-BX	-	25A at 12V DC	SPST	On-Off	Dependent	Amber	-	3 blade	Silver	IP66
58312-C4	58312-C4-BX	-	25A at 12V DC	SPST	On-Off	Dependent	Clear	-	3 blade	Silver	IP66
58312-G4	58312-G4-BX	-	25A at 12V DC	SPST	On-Off	Dependent	Green	-	3 blade	Silver	IP66
58312-R4	58312-R4-BX	-	25A at 12V DC	SPST	On-Off	Dependent	Red	-	3 blade	Silver	IP66
58312-GA4	58312-GA4-BX	-	25A at 12V DC	SPST	On-Off	1 Dependent & 1 Independent	Green	Amber	4 blade	Silver	IP66
58312-RG4	-	-	25A at 12V DC	SPST	On-Off	1 Dependent & 1 Independent	Red	Green	4 blade	Silver	IP66
58312-RR4	-	-	25A at 12V DC	SPST	On-Off	1 Dependent & 1 Independent	Red	Red	4 blade	Silver	IP66
58312-RG2	-	-	25A at 12V DC	SPDT	On-On	Dependent	Red	Green	4 blade	Silver	IP66
58312-RR2	-	-	25A at 12V DC	SPDT	On-On	Dependent	Red	Red	4 blade	Silver	IP66
-	58312-AG-BX	-	25A at 12V DC	SPDT	On-Off-On	Dependent	Amber	Green	4 blade	Silver	IP66
58312-AR	58312-AR-BX	-	25A at 12V DC	SPDT	On-Off-On	Dependent	Amber	Red	4 blade	Silver	IP66
58312-RR	58312-RR-BX	-	25A at 12V DC	SPDT	On-Off-On	Dependent	Red	Red	4 blade	Silver	IP66
58312-RG3	-	-	25A at 12V DC	SPDT	Mom On-Off-Mom On	Independent	Red	Green	6 blade	Silver	IP66
58324-R1	-	-	24V DC	SPST	On-Off	Independent	Red	-	4 blade	Silver	IP66



25A & 15A Non-Illuminated Sealed Rocker Switches

- Weather-resistant with contact areas sealed to IP66 (high pressure wash resistant)
- Silver contacts and corrosion-resistant nickel-plated brass blades for superior performance and electrical contact

PART NUMBERS			RATING	POLE & THROW	ACTION	TERMINALS	CONTACTS	SEALING	NOTES
BULK	INDIVIDUAL BOX	RETAIL CLAMSHELL							
58311-01	58311-01-BX	-	25A at 12V DC 15A at 24V DC	SPST	On-Off	2 blade	Silver	IP66	
58311-02	-	-		SPST	Mom On-Off	2 blade	Silver	IP66	
58311-03	-	-		SPDT	On-Off-On	3 blade	Silver	IP66	
58311-04	58311-04-BX	-		SPDT	Mom On-Off-Mom On	3 Blade	Silver	IP66	
58311-06	-	-		DPST	On-Off	4 blade	Silver	IP66	
58311-07	58311-07-BX	-		DPDT	On-Off-On	6 blade	Silver	IP66	
58311-08	-	-		DPDT	On-On	6 blade	Silver	IP66	
58311-11	-	-		DPDT	On-Off-On	4 blade	Silver	IP66	Forward & Reverse
58311-13	58311-13-BX	-		DPDT	Off-On-Mom On	4 blade	Silver	IP66	Ignition & Start
58311-16	-	-		DPDT	Off-On-On	4 Blade	Silver	IP66	Parking & Headlights
58311-18	-	58311-18-BP		DPDT	Mom On-Off-Mom On	4 blade	Silver	IP66	Forward & Reverse

Sealed Rocker Switches

58328 Series • 25A Incandescent Pilot Light Rocker Switches

- Series available with small pilot lights, large pilot lights or unlit
- Dependent or independent illumination
- Faceted lenses are on the actuator
- Matte black finish on the plastic housing, bezel and actuator
- Brass blade or screw terminals available
- See accessories section for bezels and mounting kits
- BP (clamshell retail pack) retail unit contains separate lenses of all colors. Lenses snap easily into place

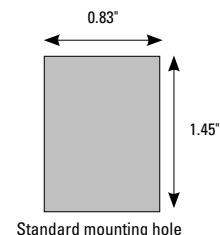

2D Prints and additional information: littelfuse.com/RockerSwitches



Faceted Colored Lens

PART NUMBERS			RATING	POLE & THROW	ACTION	ILLUMINATION	LED PILOT LIGHTS		TERMINALS	CONTACTS	SEALING
BULK	INDIVIDUAL BOX	RETAIL CLAMSHELL					LENS COLOR 1	LENS COLOR 2			
58328-01	58328-01-BX	-	25A at 12V DC	SPST	On-Off	Independent	Red	-	4 blade	Silver	IP66
58328-02	58328-02-BX	-		SPST	On-Off	Independent	Green	-	4 blade	Silver	IP66
58328-10	58328-10-BX	-		SPST	On-Off	Independent	Amber	-	4 blade	Silver	IP66
56328-101	-	-		SPST	On-Off	Independent	One lens of each color	-	4 blade	Silver	IP66
58328-04	58328-04-BX	-	25A at 12V DC	SPST	On-Off	Dependent	Red	-	3 blade	Silver	IP66
58328-11	58328-11-BX	-		SPST	On-Off	Dependent	Green	-	3 blade	Silver	IP66
58328-12	58328-12-BX	-		SPST	On-Off	Dependent	Clear	-	3 blade	Silver	IP66
58328-13	58328-13-BX	-		SPST	On-Off	Dependent	Amber	-	3 blade	Silver	IP66
58328-100	-	58328-100-BP		SPST	On-Off	Dependent	One lens of each color	-	3 blade	Silver	IP66
58328-08	-	-	25A at 12V DC	SPDT	On-On	Dependent	Green	Green	4 blade	Silver	IP66
58328-16	-	-		SPDT	On-On	Dependent	Red	Red	4 blade	Silver	IP66
58328-22	-	-		SPDT	On-On	Dependent	Green	Red	4 blade	Silver	IP66
58328-102	-	58328-102-BP		SPDT	On-On	Dependent	One lens of each color	-	4 blade	Silver	IP66
58328-06	-	-	25A at 12V DC	SPDT	On-Off-On	Dependent	Red	Clear	4 blade	Silver	IP66
58328-25	-	-		SPDT	On-Off-On	Dependent	Green	Green	4 blade	Silver	IP66
58328-26	-	-		SPDT	On-Off-On	Dependent	Red	Red	4 blade	Silver	IP66
58328-33	-	-		SPDT	On-Off-On	Dependent	Red	Green	4 blade	Silver	IP66
58328-34	-	-		SPDT	On-Off-On	Dependent	Green	Red	4 blade	Silver	IP66
58328-35	58328-35-BX	-		SPDT	On-Off-On	Dependent	Red	Amber	4 blade	Silver	IP66
58328-36	-	-		SPDT	On-Off-On	Dependent	Red	Green	4 blade	Silver	IP66
58328-103	-	58328-103-BP		SPDT	On-Off-On	Dependent	One lens of each color	-	4 blade	Silver	IP66
58328-40	-	-	25A at 12V DC	SPST	On-Off	1 Dependent & 1 Independent	Red	Red	4 blade	Silver	IP66
58328-104	-	58328-104-BP		SPST	On-Off	1 Dependent & 1 Independent	One lens of each color	-	4 blade	Silver	IP66



58327-01



58327-06

56327 & 58327 Series • 25A Small Round Lens Pilot Light Rocker Switches

- Series available with small pilot lights, large pilot lights or unlit
- Dependent or independent illumination
- Faceted lenses are on the actuator
- Matte black finish on the plastic housing, bezel and actuator
- Brass blade or screw terminals available
- See accessories section for bezels and mounting kits

2D Prints and additional information: littelfuse.com/RockerSwitches

PART NUMBERS			RATING	POLE & THROW	ACTION	ILLUMINATION	LED PILOT LIGHTS		TERMINALS	CONTACTS	SEALING	DIAGRAM page 82
BULK	INDIVIDUAL BOX	RETAIL CLAMSHELL					LENS COLOR 1	LENS COLOR 2				
56327-01	56327-01-BX	56327-01-BP	25A at 12V DC	SPST	On-Off	Dependent	Red		3 screw	Silver	IP66	F
58327-01	58327-01-BX	58327-01-BP		SPST	On-Off	Dependent	Red		3 blade	Silver	IP66	F
58327-06	58327-06-BX	58327-06-BP		SPDT	On-Off-On	Dependent	Red	Red	4 blade	Silver	IP66	J



58027-01

56027 & 58027 Series • 25A Non-Illuminated Rocker Switches

- Series available with small pilot lights, large pilot lights or unlit
- Matte black finish on the plastic housing, bezel and actuator
- Brass blade or screw terminals available
- See accessories section for bezels and mounting kits

2D Prints and additional information: littelfuse.com/RockerSwitches

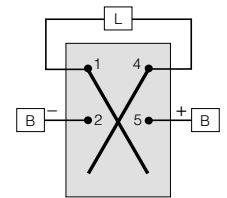

Forward-Reverse switch

PART NUMBERS			RATING	POLE & THROW	ACTION	TERMINALS	CONTACTS	SEALING	NOTES
BULK	INDIVIDUAL BOX	RETAIL CLAMSHELL							
56027-01	56027-01-BX	56027-01-BP	25A at 12V DC	SPST	On-Off	2 screw	Silver	IP66	–
58027-01	58027-01-BX	–		SPST	On-Off	2 blade	Silver	IP66	–
58027-02	58027-02-BX	58027-02-BP		SPST	Mom On-Off	2 blade	Silver	IP66	–
58027-03	58027-03-BX	58027-03-BP		SPDT	On-Off-On	3 blade	Silver	IP66	–
58027-04	58027-04-BX	58027-04-BP		SPDT	Mom On-Off-Mom On	3 blade	Silver	IP66	–
58027-06	58027-06-BX	–		DPST	On-Off	4 blade	Silver	IP66	–
58027-07	58027-07-BX	58027-07-BP		DPDT	On-Off-On	6 blade	Silver	IP66	–
58027-08	58027-08-BX	–		DPDT	On-On	6 blade	Silver	IP66	–
58027-11	58027-11-BX	58027-11-BP		DPDT	Mom On-Off-Mom On	6 blade	Silver	IP66	–
58027-18	58027-18-BX	–		DPDT	Mom On-Off-Mom On	4 blade	Silver	IP66	Forward & Reverse

Sealed Rocker Switches



M-58031 Series • 20A Rocker Switches

- Certified to IP66 for protection against dust and prolonged spray
- Recognized at UL 1500: Ignition Protection for Marine Products
- Neoprene gasket/panel seal with black nylon bezel and black plastic housing
- 20A at 12V DC. Blade terminals, silver contacts

2D Prints and additional information: littelfuse.com/RockerSwitches

PART NUMBERS			RATING	POLE & THROW	ACTION	TERMINALS	CONTACTS	SEALING
BULK	INDIVIDUAL BOX	RETAIL CLAMSHELL						
M-58031-01	M-58031-01-BX	M-58031-01-BP	20A at 12V DC	SPST	On-Off	2 Blade	Silver	IP66
M-58031-02	–	M-58031-02-BP	20A at 12V DC	SPDT	On-Off-On	3 Blade	Silver	IP66
M-58031-04	–	M-58031-04-BP	20A at 12V DC	DPST	On-Off	4 Blade	Silver	IP66
M-58031-06*	–	–	20A at 12V DC	DPDT	On-On	6 Blade	Silver	IP66
M-58031-07*	–	M-58031-07-BP	20A at 12V DC	SPST	Mom On-Off	2 Blade	Silver	IP66
M-58031-08*	–	–	20A at 12V DC	SPDT	Mom On-Off-Mom On	3 Blade	Silver	IP66
M-58031-09	M-58031-09-BX	–	20A at 12V DC	DPDT	Mom On-Off-Mom On	6 Blade	Silver	IP66



58326 Series • 20A Rocker Switches with Pilot Lights

Single or dual pilot lights. Faceted lenses inset into the actuator. Matte black plastic housing, bezel and actuator. Silver contacts. Internal seal.

- Certified to IP66 for protection against dust and prolonged spray
- Neoprene gasket/panel seal with black nylon bezel and black plastic housing
- 20A at 12V DC. Blade terminals, silver contacts
- Other imprints available upon request. Contact Littelfuse for details

2D Prints and additional information: littelfuse.com/RockerSwitches

PART NUMBERS			RATING	POLE & THROW	ACTION	ILLUMINATION	LED PILOT LIGHTS	IMPRINT		TERMINALS	CONTACTS	SEALING
BULK	INDIVIDUAL BOX	RETAIL CLAMSHELL						POSITIONS	WARNING LIGHT			
58326-01	58326-01-BX	–	20A at 12V DC	SPST	Off-On	Independent	Red	None	None	6 Blade	Silver	IP66
58326-06*	–	–	20A at 12V DC	SPDT	On-Off-Mom On	Independent	Red	Override - LVD Auto Mode - System Off	LVD Voltage Warning	5 Blade	Silver	IP66
58326-11	58326-11-BX	–	20A at 12V DC	DPST	Off-On- Mom On	Independent		Amber - Warning (On) - Off	SAE Warning Lamp symbol	6 Blade	Silver	IP66

*Special Order Item



10A Narrow Body Curved Rocker Switches

- Curved matte finish narrow body rocker switches
- Fits panels .025" through .200" (.64 to 5.2mm)
- Universal application switches
- Snap-in mounting

2D Prints and additional information: littelfuse.com/RockerSwitches

PART NUMBERS			RATING	POLE & THROW	ACTION	TERMINALS	ACTUATOR	
BULK	INDIVIDUAL BOX	RETAIL CLAMSHELL					COLOR	ILLUMINATION
54007	–	-BP	10A at 12V DC	SPDT	On-On	3 Blade	Black Face - Red Edges	–
54010	-BX	–	10A at 12V DC	SPDT	On-On	3 Blade	Black	–
54012	–	–	10A at 12V DC	SPST	Off-On	3 Blade	Red	Lit in ON Position



Rocker Switch Bezel and Mounting Accessories

Snap-in mounting of any regular size switch such as 56027, 58030, 58332, 58311, 58312 or 58328 series.

- Bezels can be arranged in a parallel array of any length. Bezels themselves can snap into a panel, or be mounted with the bracket mounting kit.
- Mounting hole in panel should be 2.02"W x 1.90"H (51.3 x 48.3mm) for two bezels. Add 1.03"W (26.2mm) for each additional unit.

Additional information: littelfuse.com/RockerSwitches



PART NUMBERS			DETAILS	NOTES	DIMENSIONS
BULK	INDIVIDUAL BOX	RETAIL CLAMSHELL			
82159-1	82159-1-BX	82159-1-BP	End Bezel	Can be used as left or right end	Two units are 2.37"W x 2.30"H (60.2 x 58.4mm)
82159-2	82159-2-BX	–	Center Bezel	Can be ganged and used with end bezels	Two units are 2.37"W x 2.30"H (60.2 x 58.4mm)
82159-3	82159-3-BX	–	Independent Bezel	Fits Panel Openings: 1.90" x 0.984" (48.3 x 25.0mm)	–
98628	98628-BX	–	Bezel Panel Plug	Fits Panel Hole: .83" x 1.45" (21.1 x 36.8mm)	Face Dimensions: 1.91" x 0.96" (24.4 x 48.8mm)
82159-02	–	82159-02-BP	2 End Bezels, 1 Center Bezel, 1 Plug	Bezel Retail Kit	–
82159-03	–	82159-03-BP	2 Center Bezels	Bezel Retail Kit	–
87167-01	–	87167-01-BP	2 Brackets, 1 Brass Stabilizing Rod	Bracket Mounting Retail Kit (holds 2 to 6 bezels)	Assembled kit mounts on top of or under the panel. Mounting holes .710"x.235" (18.0x6.7mm)

Standard Heavy Duty Rocker Switches



25A Standard Heavy-Duty Rocker Switches with and without Pilot Lights

- Narrow or wide, moisture-resistant plastic, nickel plate or black housings, bezels and actuators
- Snap-in mounting to fit panels
- Silver contacts, brass blade or screw terminals

2D Prints and additional information: littelfuse.com/RockerSwitches

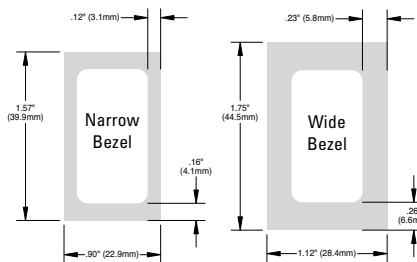

57000-23



57000-02



57000-10



57300-11



57300-11

Plastic Body Part Numbers

PART NUMBERS			RATING	POLE & THROW	ACTION	TERMINALS	ACTUATOR	CONTACTS	NOTES
BULK	INDIVIDUAL BOX	RETAIL CLAMSHELL							
56001-04	–	–	25A at 12V DC	SPST	Mom On-Off	2 Screw	White	Silver	–
56000-08	56000-08-BX	56000-08-BP	25A at 12V DC	SPST	On-Off	2 Screw	White	Silver	–
57000-23	57000-23-BX	–	25A at 12V DC	SPST	On-Off	2 Blade	White	Silver	–
57005-11*	–	–	25A at 12V DC	DPDT	On-On	6 Blade	White	Silver	–
57013-08	57013-08-BX	–	25A at 12V DC	DPDT	Mom On-Off-Mom On	6 Blade	White	Silver	–
57000-23	57000-23-BX	–	25A at 12V DC	SPST	On-Off	2 Blade	White	Silver	–

8

Metal Body Part Numbers

PART NUMBERS			RATING	POLE & THROW	ACTION	TERMINALS	WIDTH	COLOR	ACTUATOR	PILOT LIGHT	CONTACTS	DIAGRAM Page 82
BULK	INDIVIDUAL BOX	RETAIL CLAMSHELL										
56000-01*	–	–	25A at 12V DC	SPST	On-Off	2 Screw	Narrow	Nickel Plated	White		Silver	
56000-02*	–	–	25A at 12V DC	SPST	On-Off	2 Screw	Wide	Nickel Plated	White		Silver	
56000-04	56000-04-BX	–	25A at 12V DC	SPST	On-Off	2 Screw	Narrow	Nickel Plated	Black		Silver	
56300-01	56300-01-BX	–	25A at 12V DC	SPST	On-Off	3 Screw	Narrow	Nickel Plated	White	•	Silver	F
56300-11	–	–	25A at 12V DC	SPST	On-Off	3 Screw	Narrow	Nickel Plated	White	•	Silver	F
57000-01	57000-01-BX	–	25A at 12V DC	SPST	On-Off	2 Blade	Narrow	Nickel Plated	White		Silver	
57000-02	–	–	25A at 12V DC	SPST	On-Off	2 Blade	Wide	Nickel Plated	White		Silver	
57000-04	57000-04-BX	–	25A at 12V DC	SPST	On-Off	2 Blade	Narrow	Black	Black		Silver	
57000-10	57000-10-BX	–	25A at 12V DC	SPST	On-Off	2 Blade	Narrow	Black	Black		Silver	Printed: On, Off
57001-01*	–	–	25A at 12V DC	SPST	Mom On-Off	2 Blade	Narrow	Nickel Plated	White		Silver	
57003-01	57003-01-BX	–	25A at 12V DC	SPDT	On-Off-On	3 Blade	Narrow	Nickel Plated	White		Silver	
57006-01	57006-01-BX	–	25A at 12V DC	DPDT	On-Off-On	6 Blade	Narrow	Nickel Plated	White		Silver	
57007-01*	–	–	25A at 12V DC	SPDT	On-On-Off	3 Blade	Narrow	Nickel Plated	White		Silver	
57007-08*	–	–	25A at 12V DC	SPDT	On-On-Off	3 Blade	Narrow	Black	Black		Silver	
57007-11	57007-11-BX	–	25A at 12V DC	SPDT	On-On-Off	3 Blade	Narrow	Black	Black		Silver	Printed: Off, Lo, High
57300-01	57300-01-BX	–	25A at 12V DC	SPST	On-Off	3 Blade	Narrow	Nickel Plated	White	•	Silver	F
57300-03	57300-03-BX	–	25A at 12V DC	SPST	On-Off	3 Blade	Narrow	Nickel Plated	Black	•	Silver	F
57300-02	57300-02-BX	–	25A at 12V DC	SPST	On-Off	3 Blade	Wide	Nickel Plated	White	•	Silver	F

*Special Order Item



25A Narrow Body Dual Rocker Switches

- Two Single Pole switches in one body
- Universal application switches
- Snap-in mounting
- Silver contacts, brass blade terminals
- Black or white actuators, imprinted in contrasting black or white
- Snaps into panel hole 1.45" x .83" (36.8x21.1mm) and fits panels .040" thru .100" thick (1.0—2.5mm)

2D Prints and additional information: littelfuse.com/RockerSwitches

PART NUMBERS		RATING	POLE & THROW	LEFT SWITCH			RIGHT SWITCH			TERMINALS	BEZEL WIDTH	CONTACTS
BULK	INDIVIDUAL BOX			ACTION	ACTUATOR	PRINT	ACTION	ACTUATOR	PRINT			
58506-08	58506-08-BX	25A at 12V DC	SPST	On-Off	Black	On, Off	Mom On-Off	White	On, Off	4 Blade	Narrow	Silver
58506-07*	—	25A at 12V DC	SPDT	On-Off-On	Black	Hi, Off, Lo	On-Off-On	Black	Hi, Off, Lo	6 Blade	Narrow	Silver



25A Wide Body Dual Rocker Switches

- Two Single Pole switches in one body
- Universal application switches
- Snap-in mounting
- Silver contacts, copper blade terminals
- Black or white actuators, imprinted in contrasting black or white
- Snaps into panel hole 1.0" x 1.125" (25.4x28.6mm) and fits panels .030" thru .250" thick (.76 - 6.35mm)

2D Prints and additional information: littelfuse.com/RockerSwitches

PART NUMBERS			RATING	LEFT SWITCH			RIGHT SWITCH			TERMINALS	BEZEL WIDTH
BULK	INDIVIDUAL BOX	RETAIL CLAMSHELL		ACTION	ACTUATOR	PRINT	ACTION	ACTUATOR	PRINT		
54204-01	54204-01-BX	—	10A at 12V DC	On1-Off-On2	Black Rocker	Hi, Lo	On1-Off-On2	Black Rocker	Hi, Lo	6 Blade	Wide
54403-01*	—	—	10A at 12V DC	Black Panel	—	—	On1-Off-On2	Black Rocker	Hi, Lo	3 Blade	Wide

*Special Order Item

Toggle Switches



Dependent or Independent Illumination?

Dependent:

The actuator is illuminated only when the switch is turned on.

Independent:

Illumination is not affected by the actuation of the switch. The illumination can be switched on or off by another switch, such as headlight or interior lighting controls. This is especially useful when locating switches in the dark.

What does SPST or DPST mean?

The first two letters, SP or DP, refer to single pole or double pole. The second two letters, ST or DT refer to single throw or double throw.

Pole refers to the number of circuits controlled by the switch. SP switches control one circuit and DP switches control two independent circuits (which act like two identical switches that are mechanically linked). Pole is often confused with terminal, which is a common mistake. Terminals are used for wire connections on the back of the unit and are specified separately.

Throw refers to the extreme position of the actuator. ST switches close a circuit at only one position and the other position is off. DT switches close a circuit in the Up position, as well as the down position and can be configured with two positions (On-Off) or three positions (On-Off-On).

12V, 24V, 36V ratings

Generally, our 12V non-illuminated toggle switches can be used at higher voltages (and lower current ratings). By proportional calculation a 25A 12V can be used at 8.3A at 36V or 12.5A at 24V. This 'de-rating' actually gives a conservative result. 25A at 12V toggles can actually be used at 15A at 24V and 10A at 36V.

Warning: Switches with pilot lights must be used only at the stated voltage, since the lighting elements function at a specific voltage.

55025 Series • 25A Sealed Toggles



- Waterproof and dustproof to IP68 standard – allows mounting in demanding or harsh locations
- Bushing, handle and hardware – nickel-plated brass
- Standard handle, 0.60" long (15.3mm)
- Standard mounting panel hole 0.468 – 0.474" diameter (11.9-12.0mm)
- Standard bushing diameter 0.47 (12.0mm) 15/32" thread, 0.32" long (5.8mm)
- Wires: 14AWG (2mm²), 12" long (304.8mm)
- Switch body: 1.24" deep x 0.87" wide x 1.46" high (31.6 x 22.0 x 37.1mm)

2D Prints and additional information: littelfuse.com/55025

PART NUMBERS			RATING	POLE & THROW	ACTUATOR	ACTION	TERMINALS	CONTACTS	SEALING
BULK	INDIVIDUAL BOX	RETAIL CLAMSHELL							
55025	55025-BX	55025-BP	25A at 12V DC	SPST	Nickel-plated brass handle	On-Off	2 wire	Silver	IP68
55025-01	55025-01-BX	55025-01-BP		SPST		Mom On-Off	2 wire		IP68
55025-02	55025-02-BX	55025-02-BP		SPDT		On-Off-On	3 wire		IP68
55025-03	55025-03-BX	55025-03-BP	15A at 24V DC	SPDT	Nickel-plated brass handle	On-On	3 wire	Silver	IP68
55025-04	55025-04-BX	55025-04-BP		SPDT		On-Off-Mom On	3 wire		IP68
55026	-	-		SPST		On-Off	4 wire		IP68



Standard Switch



Illuminated Switch

54100 Series • 25A Standard or Illuminated Toggles

Available in a standard black nylon handle or a lighted clear plastic handle, that is 11/16" (17.5mm) long.

- Mounting stem 15/32"-32 thread, 15/32" (11.9mm) long, fits panels up to 1/8" (31.8mm) thick
- Includes mounting hardware: black metal facenut and nickel-plated hexnut
- Terminals: .250" blade or 6-32 screw

2D Prints and additional information: littelfuse.com/54100

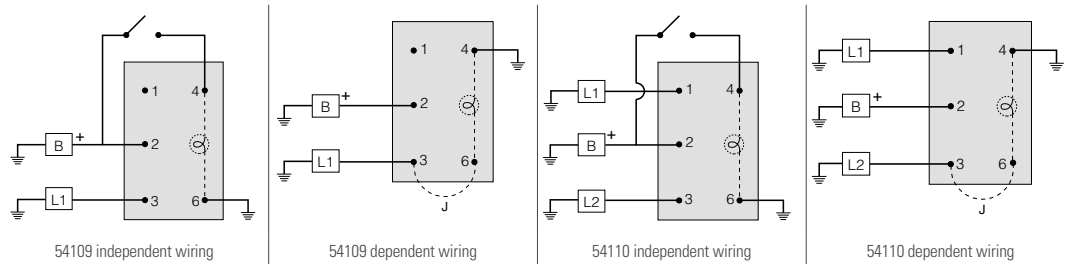

PART NUMBERS			RATING	POLE & THROW	ACTUATOR	ACTION	ILLUMINATION	ILLUMINATION COLOR			TERMINALS	CONTACTS	SEALING
BULK	INDIVIDUAL BOX	RETAIL CLAMSHELL						DOWN	CENTER	UP			
54100	54100-BX	54100-BP	25A at 12V DC	SPST	Black Plastic Paddle	On-Off	-	-	-	2 screw	Silver	-	
54101-01*	-	-		SPST	Black Plastic Paddle	Mom On-Off	-	-	-	2 blade		-	
54109	54109-BX	54109-BP		SPST	Clear Plastic Paddle	On-Off	Independent or Dependent	White	-	Red	4 screw	O-ring in bushing	
54103	54103-BX	54103-BP		SPDT	Black Plastic Paddle	On-Off-On	-	-	-	-	3 screw	-	
54104	54104-BX	54104-BP		SPDT	Black Plastic Paddle	Mom On-Off-Mom On	-	-	-	-	3 screw	-	
54110*	-	-		SPDT	Clear Plastic Paddle	On-Off-On	Independent or Dependent	White	White	Red	4 screw	O-ring in bushing	
54105	-	-		DPST	Black Plastic Paddle	On-Off	-	-	-	-	4 screw	-	
54107	54107-BX	-		DPDT	Black Plastic Paddle	On-Off-On	-	-	-	-	6 screw	-	

*Special Order Item

Toggle Switches

Heavy Duty • 25A Toggles

Standard or long handle. Universal application. Mounting stem is nickel-plated brass 15/32"-32 thread, 15/32" (11.9mm) long, and fits panels up to 9/32" (7.1mm) except where stated otherwise. Phenolic housing, with plated steel cap.

2D Prints and additional information: littelfuse.com/ToggleSwitches



Standard handle, 11/16" (17.5mm) long.



Long handle, 1 1/2" (38.1mm) long.



PVC coated housing with wire leads.

PART NUMBERS			RATING	POLE & THROW	ACTUATOR LENGTH	MATERIAL	ACTION	TERMINALS	CONTACTS	PVC COATED	SEALING	
BULK	INDIVIDUAL BOX	RETAIL CLAMSHELL										
5520	5520-BX	5520-BP	25A at 12V DC, 15A at 24V DC	SPST	Standard	Nickel-Plated Brass	On-Off	2 screw	Silver		O-ring	
5582	5582-BX	5582-BP		SPST	Standard		On-Off	2 screw			-	
5582-10	5582-10-BX	-		SPST	Standard		On-Off	2 wire			O-ring	
55014	55014-BX	55014-BP		SPST	Standard		On-Off	2 blade			-	
55014-05	55014-05-BX	-		SPST	Standard		On-Off	2 blade			O-ring	
55023	55023-BX	-		SPST	Standard		On-Off	2 screw			-	
55055	55055-BX	55055-BP		SPST	Long		On-Off	2 blade			-	
55020-04	55020-04-BX	55020-04-BP		SPST	Standard		Off-Mom On	2 wire			•	O-ring
5584	5584-BX	-		SPDT	Standard		On-On	3 screw			-	
5586	5586-BX	5586-BP		SPDT	Standard		On-Off-On	3 screw			-	
55015	55015-BX	-		SPDT	Standard		On-On	3 blade			-	
55016	55016-BX	-		SPDT	Standard		On-Off-On	3 blade			-	
55036	55036-BX	-		SPDT	Standard		On-Off-On	3 wire			•	O-ring
55021	55021-BX	55021-BP		SPDT	Standard		Mom On-Off-Mom On	3 screw			-	
55021-07	55021-07-BX	55021-07-BP		SPDT	Standard		Mom On-Off-Mom On	3 wire			•	O-ring
55033-01	55033-01-BX	-		SPDT	Standard		Mom On-Off-Mom On	3 blade			-	
55088	55088-BX	55088-BP		SPDT	Standard		On-Off-Mom On	3 screw			-	
55017	55017-BX	-		DPST	Standard		On-Off	4 blade			-	
5590	5590-BX	-		DPDT	Standard		On-On	6 screw			-	
5592	5592-BX	5592-BP		DPDT	Standard		On-Off-On	6 screw			-	
55018	55018-BX	-		DPDT	Standard		On-On	6 blade			-	
55019	55019-BX	55019-BP		DPDT	Standard		On-Off-On	6 blade			-	
55054	55054-BX	55054-BP		DPDT	Standard		Mom On-Off-Mom On	6 screw			-	
55054-04	55054-04-BX	-		DPDT	Long		Mom On-Off-Mom On	6 screw			-	
55065-02	55065-02-BX	-		DPDT	Long		Mom On-Off-Mom On	6 blade			-	
55065-03	55065-03-BX	-		DPDT	Standard		Mom On-Off-Mom On	6 blade			-	
55046	55046-BX	-		DPDT	Standard		Mom On-Off-Mom On	4 blade			-	

9

Medium Duty • 10A Toggles

- Standard or ball handle
- Mounting stem has 15/32"-32 thread, 15/32" (11.9mm) long, and fits panels up to 9/32" (7.2mm) thick

2D Prints and additional information: littelfuse.com/ToggleSwitches



Ball handle: 3/8" (9.52mm) long



Standard handle: 11/16" (17.46mm) long

PART NUMBERS			RATING	POLE & THROW	ACTUATOR		ACTION	TERMINALS	CONTACTS
BULK	INDIVIDUAL BOX	RETAIL CLAMSHELL			TYPE	MATERIAL			
5507	5507-BX	-	10A at 12V DC	SPST	Ball	Nickel-Plated Brass	Off-On	2 screw	Silver
5558	5558-BX	5558-BP	10A at 12V DC	SPST	Standard	Nickel-Plated Brass	Off-On	2 screw	Silver
5565	-	-	10A at 12V DC	SPST	Ball	-	Off-On	2 wire	-

551800 Series • 30A Extra Heavy Duty Toggles

Universal application. Diecast housing. For stem- or bracket-mounting. 15/32"-32 thread mounting stem, with keyway.



- Brackets: .170" (4.3mm) diameter holes, 1.72" (43.7mm) on centers
- Fits panels up to 3/16" (4.8mm) thick
- Chrome plated brass handle, 1 1/16" long (27.0mm)

2D Prints and additional information: littelfuse.com/ToggleSwitches

PART NUMBERS			RATING	POLE & THROW	ACTION	ACTUATOR	TERMINALS	CONTACTS
BULK	INDIVIDUAL BOX	RETAIL CLAMSHELL						
551001	551001-BX	-	20A at 6-12V DC	SPST	Mom On-Off	Chrome-plated brass handle	2 blade	Silver
551800	551800-BX	-		SPST	On-Off		2 screw	
551801	-	-		SPST	Mom On-Off		2 screw	
551802	551802-BX	-		SPDT	On-Off-On		3 screw	
551805*	-	-		SPDT	On-Off		4 screw	
551806	551806-BX	-		DPDT	On-Off-On		6 screw	
551840	551840-BX	551840-BP	-	SPST	On-Off		2 screw	
551841	551841-BX	-	30A at 6-12V DC 15A at 24-36V DC	SPST	Mom On-Off		2 screw	
551842	551842-BX	-		SPDT	On-Off-On		3 screw	
551843	551843-BX	-		SPDT	On-Off-Mom On		3 screw	
551844	551844-BX	-		SPDT	Mom On-Off-Mom On		3 screw	
551845	551845-BX	-		DPST	On-Off		4 screw	
551846	551846-BX	-		DPDT	On-Off-On	6 screw		
551849	551849-BX	-		SP3C	On-On-Off	4 screw		
551850*	-	-		SPDT	On-On	3 screw		
551851	-	-		SPST	On-Mom Off	2 screw		
551855	-	-		SP1C	Mom Off-On-Off	2 screw		
551861	-	-	SP2C	On-Off	3 screw			
551862	551862-BX	-	DP2C	Mom On-Run-Off	4 screw			

M-54111 Series • 25A Lighted Tip Toggles

Tip of handle is illuminated Red in the On position, illuminated Clear in the Off position.

2D Prints and additional information: littelfuse.com/ToggleSwitches

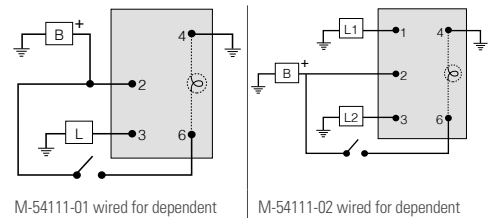

PART NUMBERS			RATING	POLE & THROW	ACTION	ACTUATOR	ILLUMINATION	ILLUMINATION COLOR		TERMINALS	CONTACTS
BULK	INDIVIDUAL BOX	RETAIL CLAMSHELL						ON	OFF		
M-54111-01	M-54111-01-BX	M-54111-01-BP	25A at 12V DC	SPST	On-Off	Black plastic handle w/ illuminated tip	Independent or Dependent	Red	White	4 blade	Silver
M-54111-02	M-54111-02-BX	M-54111-02-BP	25A at 12V DC	SPDT	On-Off-On	Black plastic handle w/ illuminated tip	Independent or Dependent	Red	White	5 blade	Silver

*Special Order Item

Toggle Switches



59024 Series • 25A Long Handle "Duck Bill" Toggles

- 15/32"-32 thread mounting stem
- Fits panels up to 1/4" (6.4mm) thick
- Includes mounting hardware: black knurled facenut, hexnut
- Keyway is in the down position. 1" (25.4mm) handle, black plastic, matte finish
- Terminals: .250" blade or 8-32 screw

2D Prints and additional information: littelfuse.com/ToggleSwitches

PART NUMBERS			RATING	POLE & THROW	ACTION	ACTUATOR	TERMINALS	CONTACTS	SEALING
BULK	INDIVIDUAL BOX	RETAIL CLAMSHELL							
59024-100	59024-100-BX	-	25A at 12V DC	SPST	On-Off	Black Plastic Duck Bill Paddle	2 blade	Silver	-
59024-101*	-	-		SPST	On-Off		2 blade		O-ring in stem
59024-102*	-	-		SPST	Mom On-Off		2 blade		-
59024-104*	-	-		SPDT	On-On		3 blade		-
59024-106	59024-106-BX	-		SPDT	On-Off-On		3 blade		-
59024-108	59024-108-BX	-		SPDT	Mom On-Off-Mom On		3 blade		-
59024-110	59024-110-BX	-		DPST	On-Off		4 blade		-
59024-116	59024-116-BX	-		DPDT	On-On		6 blade		-
59024-118	59024-118-BX	-		DPDT	On-Off-On		6 blade		-
59024-200	59024-200-BX	-		SPST	On-Off		2 screw		-
59024-201*	-	-		SPST	On-Off		2 screw		O-ring in stem
59024-202*	-	-		SPST	Mom On-Off		2 screw		-
59024-204*	-	-		SPDT	On-On		3 screw		-
59024-206*	-	-		SPDT	On-Off-On		3 screw		-
59024-208*	-	-		SPDT	Mom On-Off-Mom On		3 screw		-
59024-210*	-	-		DPST	On-Off		4 screw		-
59024-216*	-	-		DPDT	On-On		6 screw		-
59024-218*	-	-		DPDT	On-Off-On		6 screw		-

9



59024-00 Series • Freightliner Replacement "Duck Bill" Toggle Switches

Black phenolic switch housing with metal cap. Terminals are arranged to match OEM wiring connectors with or without brackets.

- Fits panels to .093" (2.4mm) with spacer provided, or to .25" (6.4mm) without spacer
- 15/32"-32 thread mounting stem
- Includes mounting hardware: black metal facenut. Keyway is in the down position
- Black plastic 1" (25.4mm) handle, matte finish
- Dual contacts for extra durability

2D Prints and additional information: littelfuse.com/ToggleSwitches

PART NUMBERS			RATING	POLE & THROW	ACTION	ACTUATOR	TERMINALS	CONTACTS	DUAL CONTACTS	MOUNTING BRACKET
BULK	INDIVIDUAL BOX	RETAIL CLAMSHELL								
59024-33	59024-33-BX	-	25A at 12V DC	SPST	On-Off	Black Plastic Duck Bill Paddle	2 blade	Silver	•	•
59024-34*	-	-		SPDT	On-Off-On		3 blade		•	•
59024-35	59024-35-BX	-		DPST	On-Off		4 blade		•	•
59024-36	59024-36-BX	-		DPDT	On-Off-On		6 blade		•	•
59024-38	59024-38-BX	-		DPDT	Mom On-On-Mom On		6 blade		•	•
59024-12	59024-12-BX	-		SPST	On-Off		2 blade		•	•
59024-13*	-	-		SPDT	On-Off-On		3 blade		•	•
59024-14	59024-14-BX	-		DPST	On-Off		4 blade		•	•
59024-15	59024-15-BX	-		DPDT	On-Off-On		6 blade		•	•
59024-16*	-	-		DPST	On-Mom Off		4 blade		•	•

*Special Order Item

Specialized Application Toggles

- Specialized toggle switches have specific functions and applications. See the "APPLICATION NOTES" column below for details
- 15/32"-32 thread mounting stem, .46" (11.9mm) long, mounts in panels up to 9/32" (7.1mm) thick
- Nickel-plated brass handle: standard .687" (17.5mm) or long 1.5" (38.1mm)

2D Prints and additional information: littelfuse.com/ToggleSwitches

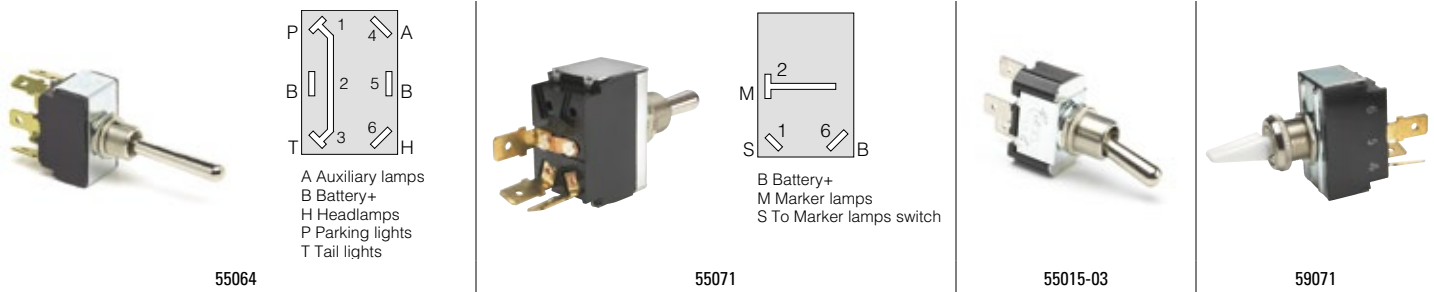

PART NUMBERS		RATING	POLE & THROW	ACTION			ACTUATOR		TERMINALS	CONTACTS	APPLICATION NOTES
BULK	INDIVIDUAL BOX			UP	CENTER	DOWN	HANDLE LENGTH	MATERIAL			
55064	55064-BX	25A at 12V DC	DPDT 4-circuit	Park, Tail & Headlamps	Off	Park, Tail & Auxiliary Lamps	Long	Nickel-Plated Brass	6 blade	Silver	4-Circuit Headlamp Switch
55071*	-	25A at 12V DC	DP 2-circuit	Mom On B, 1&2 (Day Signaling)	On 1&2	Mom Off (Night Signaling)	Standard	Nickel-Plated Brass	3 blade	Silver	2-Circuit Marker Lamp Switch
55015-03	55015-03-BX	25A at 12V DC	SPDT	On	-	On	Standard	Nickel-Plated Brass	3 blade	Silver	3-way Lighting Switch See Diagrams Below
59071	59071-BX	25A at 12V DC	DP	Mom On 1, 4&5	On 4&5	Off	Standard	White Plastic	3 blade	Silver	Ignition/Start

3- and 4-way Lighting

3-way lighting permits a light (or a set of lights) to be controlled from two switches usually mounted in different locations. Similarly, 4-way lighting enables control from three switch locations.

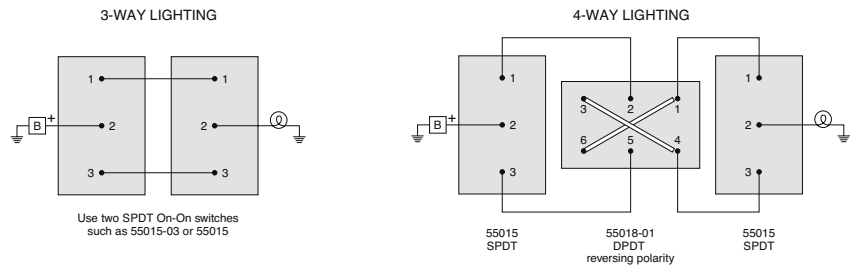

Toggle Accessories



PART NUMBERS			DESCRIPTION
BULK	INDIVIDUAL BOX	RETAIL CLAMSHELL	
82468	82468-BX	-	Flip Cover Switch Guard
5543	5543-BX	-	5558 switch mounted in 5543-15 Recessed Faceplate Switch Guard
5543-15	5543-15-BX	-	Recessed Faceplate Switch Guard
81255	81255-BX	81255-BP	Half-Boot Seal
81264	81264-BX	81264-BP	Grey Boot Seal (other colors available, please contact Littelfuse)
81264-01	81264-01-BX	81264-01-BP	Black Boot Seal (other colors available, please contact Littelfuse)
81264-05	81264-05-BX	-	Red Boot Seal (other colors available, please contact Littelfuse)

*Special Order Item

Switch Diagrams

Switch Reference Guide - SPST, SPDT, DPST, DPDT

SP and DP refer to single pole and double pole, ST and DT refer to single throw and Double throw.

SP: Single Pole, one circuit controlled by the switch.

DP: Double Pole two independent circuits controlled by the switch which are mechanically linked.

Note: "Pole" should not be confused with "Terminal". The DPST switch, for example has four terminals however is a Double Pole (DP) and not a four pole (4P) switch.

ST: Single Throw, closes a circuit at only one position. The center position is off.

DT: Double Throw, closes a circuit in the up or down position (On-On). A Double Throw switch can also have a center position such as On-Off-On.

The following switch diagrams illustrate the most common types of toggle and rocker switch.

SPST On-Off

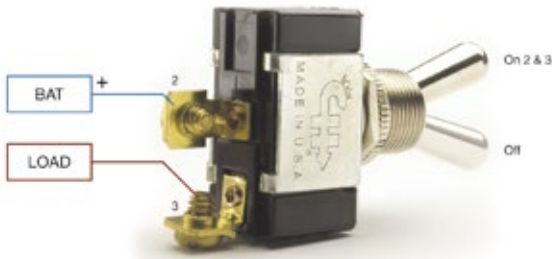

SPDT On-On

Only one of the loads can be energized at a time.

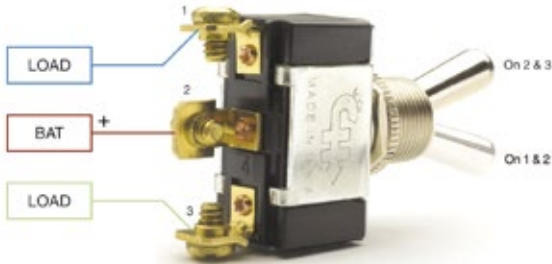

SPDT On-Off-On

Only one of the loads can be energized at a time.

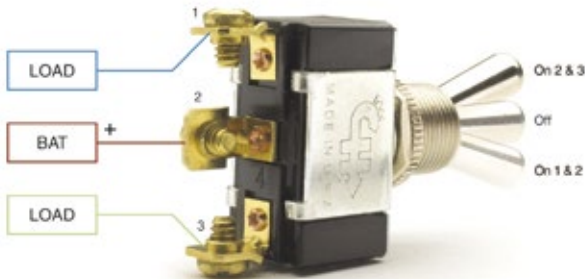

DPST On-Off

Both load terminals can be energized at the same time. They are independent of each other and could be of different voltages.

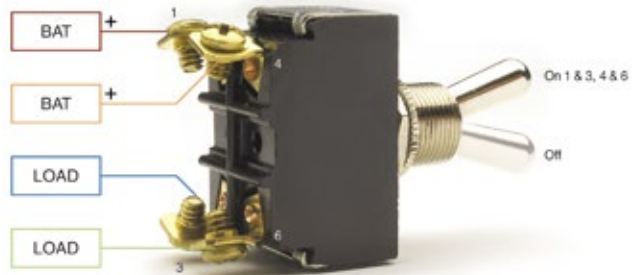

DPDT On-On

Functions like two separate SPDT switches operated by the same actuator. Only two loads can be On at a time.

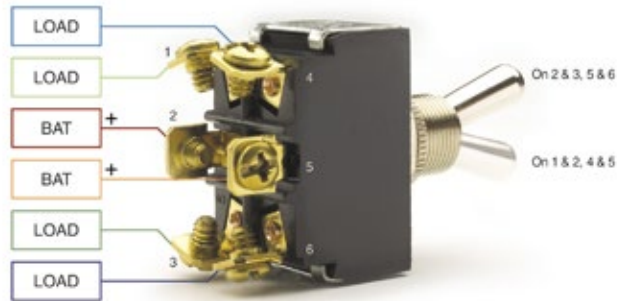

DPDT On-Off-On

Functions like two separate SPDT switches operated by the same actuator. Only two loads can be On at a time.



Switch Diagrams

Single-Pole (SP) & Double-Pole (DP) Switch Wiring Diagrams

Diagrams represent both momentary contact or maintained contact switches.

Switches without Pilot Lights

SPST Off-ON (2 terminals)

Diagram A

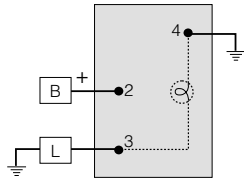
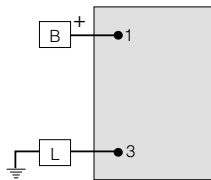
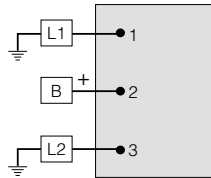

Diagram A1



SPDT On-Off-On (3 terminals)

Diagram B



-

-

DPST Off-Off (4 terminals)

Diagram C

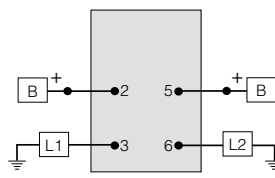
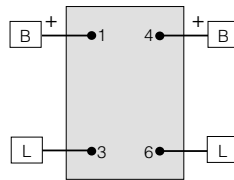
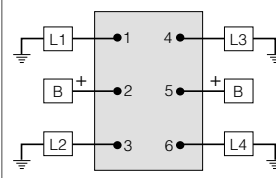

Diagram C1



DPDT On-On (6 terminals)

Diagram D



-

-

DPDT On-Off-On (6 terminals)

Diagram E

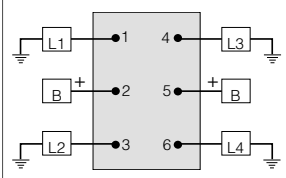

-

-

Switches with One Pilot Light

SPST Off-ON – Dependent Illumination (Three terminals)

Diagram F

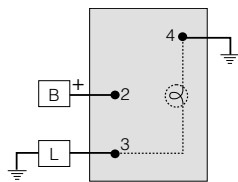

SPST Off-Off – Independent Illumination (Four terminals)

Diagram G1

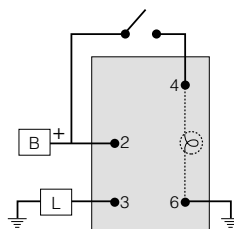

SPST Off-Off – Independent converted to Dependent (4 terminals)
To convert, connect jumper wire from terminal 3 to terminal 6 and connect terminal 4 to ground

Diagram G2

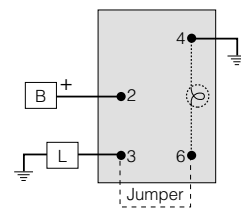

Switches with Two Pilot Lights

SPST Off-Off Dependent & Independent (Four terminals)

Diagram H

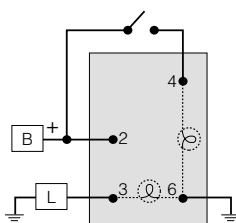

SPDT On-Off-On or On-On dependent (Four terminals)

Diagram J

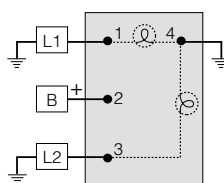

SPDT On-Off-On or On-On Independent (Four terminals)

Diagram K

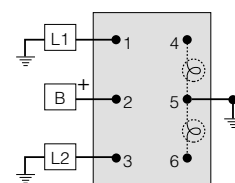

Momentary Switches

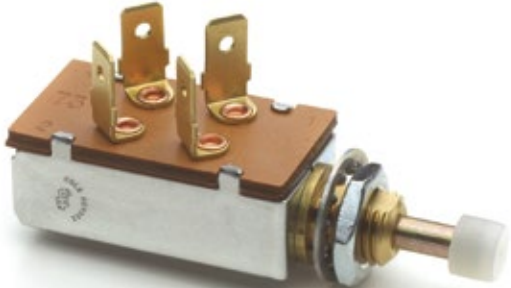

Momentary switches operate by pushing a button either by thumb or by the closing of a door and will remain in their switched state as long as they are being actuated. Momentary Switches are either “normally Off, spring return to Off” or “normally On, spring return to On.”

More Moms!

Find more momentary switches (moms) in the following catalog sections.

Rocker Switches

Toggle Switches

Ignition Switches

Foot-Operated Switches

What Does Momentary Mean?

A momentary switch, also known as a “mom,” is spring-loaded. When pressed the actuator moves, remove your finger and it returns to its original position. Opposite of a momentary switch is a maintained contact switch. When the actuator is pressed it stays in the position until it is pressed in the other direction. Many styles of moms are available including:

- Push-Pull
- Push Button
- Rotary
- Toggle
- Rocker



Momentary Push-Button Switches

35A • Heavy Duty Cylindrical Housing Push-Button Switches

For applications to 36V DC. On with button depressed, spring return to Off.

Additional information: littelfuse.com/Push-Button-Switches



PART NUMBERS			RATING	POLE & THROW	ACTION	NORMAL POSITION	ACTUATOR		TERMINALS	CONTACTS	MOUNTING STEM	NOTES
BULK	INDIVIDUAL BOX	RETAIL CLAMSHELL					DETAIL	CAP				
9095	9095-BX	9095-BP	35A at 12V DC 20A at 24V DC	SPST	Off-On	Normally Off	Chrome Plated Button	–	2 Screw	Silver	5/8"-32 thread 21/32" long	–
9245	9245-BX	9245-BP	35A at 12V DC 20A at 24V DC	SPST	Off-On	Normally Off	Black Plastic Button	Snap-On Black Rubber	2 Screw	Silver	5/8"-32 thread 21/32" long	O-ring Seal
90036-02	90036-02-BX	–	35A at 12V DC 20A at 24V DC	SPST	Off-On	Normally Off	Chrome Plated Button	–	2 Blade	Silver	5/8"-32 thread 21/32" long	Fits Delphi (Packard) 2-way Connector 2973407
9155	–	–	35A at 12V DC 20A at 24V DC	SPST	Off-On	Normally Off	Chrome Plated Large 5/16"Ø Button	–	2 Screw	Silver	5/8"-32 thread 21/32" long	–
9231	9231-BX	–	35A at 12V DC 20A at 24V DC	SPST	Off-On	Normally Off	Recessed Chrome Plated Button	–	2 Screw	Silver	5/8"-32 thread 21/32" long	Protected Button with Recessed Design
90030	90030-BX	90030-BP	35A at 12V DC 20A at 24V DC	SPST	Off-On	Normally Off	Black Plastic Button	Screw-On Black Rubber	2 Screw	Silver	5/8"-32 thread 21/32" long	–
90030-01	90030-01-BX	–	35A at 12V DC 20A at 24V DC	SPST	Off-On	Normally Off	Black Plastic Button	Screw-On Brown Oil-Resistant Rubber	2 Screw	Silver	5/8"-32 thread 21/32" long	–
90030-04	90030-04-BX	–	35A at 12V DC 20A at 24V DC	SPST	Off-On	Normally Off	Black Plastic Button	Screw-On Red Rubber	2 Screw	Silver	5/8"-32 thread 21/32" long	–

10A • Heavy Duty Rectangular Housing Push-Button Switches

For applications to 36V DC. On with button depressed, spring return to Off.

Additional information: littelfuse.com/Push-Button-Switches

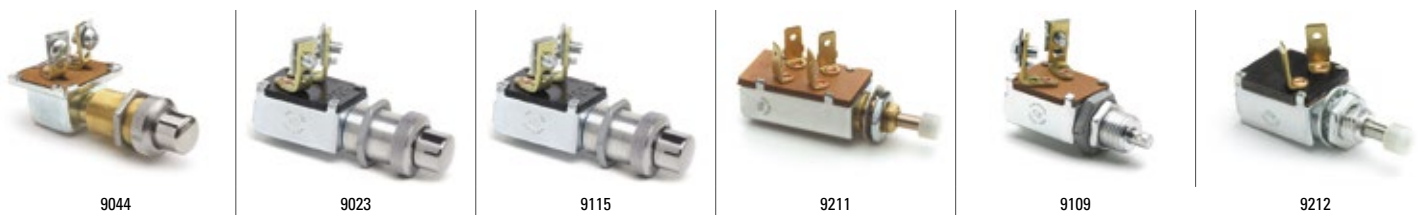

PART NUMBERS			RATING	POLE & THROW	ACTION	NORMAL POSITION	ACTUATOR		TERMINALS	MOUNTING STEM	NOTES
BULK	INDIVIDUAL BOX	RETAIL CLAMSHELL					DETAIL	CAP			
9044	9044-BX	–	10A at 12V DC	SPST	Off-On	Off	Chrome Plated Button	–	2 Screw	5/8"-32 thread 1.06" long	Gasket Seal
9023	9023-BX	–	15A Resistive, 10A Inductive at 12V DC 8A Resistive, 5A Inductive at 24V DC	SPST	Off-On	Off	Chrome Plated Button	–	2 Screw	5/8"-32 thread .87" long	–
9238	9238-BX	–	15A Resistive, 10A Inductive at 12V DC 8A Resistive, 5A Inductive at 24V DC	SPST	Off-On	Off	Chrome Plated Button	–	2 Blade	5/8"-32 thread .87" long	–
9115*	9115-BX	–	10A at 12V DC	SPST	On-Off	On	Chrome Plated Button	–	2 Screw	5/8"-32 thread 7/8" long	–
9211	9211-BX	–	10A at 12V DC	DPST	On-Off	On	White Plastic .33"Ø Button	–	4 Blade	7/16"-20 thread	Commonly used in school bus stepwell and door control
9109	9109-BX	–	10A at 12V DC	SPST	Off-On	Off	Shaft has 3/32" hole for cable or lever attachment	–	2 Screw	½"-20 thread 5/8" long	Pull On, Spring Return to Off
9212	9212-BX	–	10A at 12V DC	SPST	On-Off	On	½" Plunger	Nylon Cap	2 Blade	7/16"-20 thread ½" long	Brass Contacts
9165	9165-BX	–	10A at 12V DC 10	DPST	Off-On	Off	Chrome Plated Button	–	3 Screw	5/8"-32 thread 21/32" long	2 steel hexnuts and facerut on stem

*Special Order Item

10

Momentary Push-Button Switches

20A • Heavy Duty Rectangular Housing Push-Button Switches for Mechanical Activation

10A at 24V DC, 20A at 12V DC. On with button depressed, spring return to Off.

- Steel button protrudes through the cap. Black rubber cap snaps into a special groove on the nut, which is deep-threaded and gives a positive seal
- Steel button feature is ideal for mechanical actuation

Additional information: littelfuse.com/Push-Button-Switches



90043



90043-07

PART NUMBERS			RATING	POLE & THROW	ACTION	NORMAL POSITION	ACTUATOR		TERMINALS	MOUNTING STEM	GASKET SEAL	NOTES
BULK	INDIVIDUAL BOX	RETAIL CLAMSHELL					DETAIL	CAP				
90043	90043-BX	–	20A at 12V DC 10A at 24V DC	SPST	Off-On	Off	Steel Plunger	Snap-On Black Rubber	2 Blade	5/8"-32 thread .625" long	•	Fits Delphi (Packard) 2-Pole Connector 2977647
90043-07	90043-07-BX	–	20A at 12V DC 10A at 24V DC	SPST	Off-On	Off	Steel Plunger	Snap-On Black Rubber	2x 7" wire leads	5/8"-32 thread .625" long	•	PVC-Coated

10A • PVC-Coated Heavy Duty Rectangular Housing Push-Button Switches

For applications to 36V DC. On with button depressed, spring return to Off.

- Corrosion-resistant brass case
- PVC-Coated body sealed against moisture and dirt, with black rubber snap-on cap (407-03)
- Fits panels up to 1/2" (12.7mm) thick

Additional information: littelfuse.com/Push-Button-Switches



PART NUMBERS			RATING	POLE & THROW	ACTION	NORMAL POSITION	ACTUATOR		TERMINALS	MOUNTING STEM	PVC-COATED
BULK	INDIVIDUAL BOX	RETAIL CLAMSHELL					DETAIL	CAP			
M-608	M-608-BX	M-608-BP	10A at 12V DC	SPST	Off-On	Off	Brass Button	Rubber	2 wire leads	5/8"-32 thread 15/16" long	•

10

Threaded and Push Button Caps

- Threaded rubber cap is permanently fastened to the integral mounting nut by a rolled brass bezel
- Snap-on rubber caps feature ribs on the inside of the rubber cap engage with the switch facenet



83280



83280-03



83280-02



407-01



407-03

PART NUMBERS			TYPE	COLOR	IMPRINT	NOTES
BULK	INDIVIDUAL BOX	RETAIL CLAMSHELL				
83280	83280-BX	–	Screw-On - 5/8"-32 threads	Grey	PUSH	–
83280-02	83280-02-BX	–	Screw-On - 5/8"-32 threads	Red	PUSH	–
83280-03	83280-03-BX	83280-03-BP	Screw-On - 5/8"-32 threads	Black	PUSH	–
83280-05	83280-05-BX	–	Screw-On - 5/8"-32 threads	Brown	PUSH	Molded from Hydrin which is more resistant to fuel and oils
407-01	–	407-01-BP	Snap-On	Grey	PUSH	–
407-02*	–	–	Snap-On	Red	PUSH	–
407-03	407-06-BX	407-03-BP	Snap-On	Black	PUSH	–

*Special Order Item

Engine Start / Engine Stop Buttons



90047



90048

- Diecast housing, with knurled aluminum facenut
- Two screw terminals with lockwashers
- Mounting stem 7/8"-24 thread, keyed to prevent turning, fits panels .04" - .10" thick (1.0 - 2.5mm)
- Impact-resistant molded plastic button with white imprint, repels oil, water and other liquids
- 2 7/32" L x 1 1/8" D (50.8 x 28.6 x 3.18mm)

PART NUMBERS			RATING	POLE & THROW	ACTION	NORMAL POSITION	DETAIL	IMPRINT	TERMINALS	CONTACTS	MOUNTING STEM	SEALING
BULK	INDIVIDUAL BOX											
90047	90047-BX		35A at 12V DC	SPST	Off-On	Normally Off	Black Plastic Button	Start	2 Screw	Silver	7/8"-24 thread	-
90047-01	90047-01-BX			SPST	Off-On	Normally Off	Black Plastic Button	Start	2 Screw	Silver	7/8"-24 thread	Built-In Seal Around Lip
90048	90048-BX		20A at 24V DC	SPST	Off-On	Normally Off	Red Plastic Button	Stop	2 Screw	Silver	7/8"-24 thread	-
90048-01	90048-01-BX			SPST	Off-On	Normally Off	Red Plastic Button	Stop	2 Screw	Silver	7/8"-24 thread	Built-In Seal Around Lip

Horn Push Buttons

Surface and clamp mount push-button horn switches.



96101



96102

PART NUMBERS			RATING	TYPE	SIZE	DETAIL	TERMINALS	NOTES
BULK	INDIVIDUAL BOX	RETAIL CLAMSHELL						
96101	96101-BX	96101-BP	5A at 12V DC	Surface Mount	13/16"Ø	Black Plastic	2 Screw	-
96102	-	-	5A at 12V DC	Clamp Mount	1-3/4"Ø	Ivory Plastic	2 Screw	Clamp allows attachment on a steering column up to 1-1/2"Ø

Compact Design Buttons

- Moisture-resistant molded plastic case
- Snaps into .80 - .85" (20.3 - 21.6mm) diameter hole. Fits panels .03 - .07" thick (.76 - 1.8mm)
- Two female bullet terminals, plastic plunger 9/16" (14.3mm) long
- Replaces: Delco 1972534, Ford B0A, B9a, B9MF, C3AZ, C5AZ, C607, FEW, OA-13713-A, Jeep 805699, Motorcraft SW-265, 395, Peterbilt 16-03030



9075

PART NUMBERS			RATING	POLE & THROW	ACTION	NORMAL POSITION	DETAIL	TERMINALS
BULK	INDIVIDUAL BOX							
9075	9075-BX		5A at 12V DC	SPST	On-Mom Off	Normally On	Black Plastic 9/16" long	2 Female Bullet

Momentary Door Switches

Door Momentary Switches without Faceplates

Additional information: littelfuse.com/Door-Switches

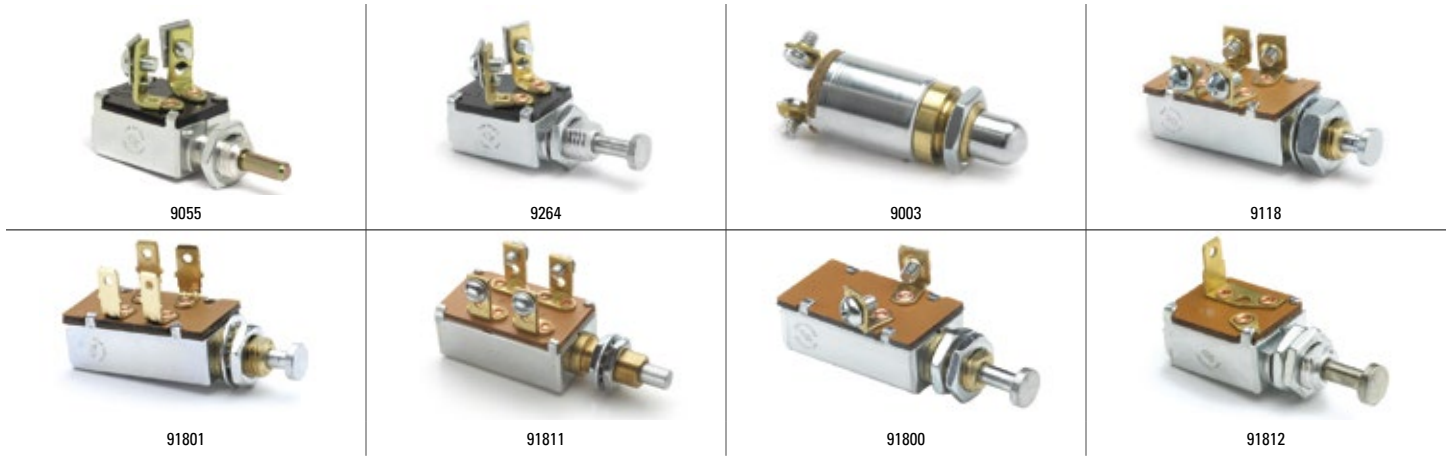

PART NUMBERS		RATING	POLE & THROW	POSITIONS	ACTION	NORMAL POSITION	ACTUATOR		TERMINALS	CASE	CONTACTS	MOUNTING	NOTES
BULK	INDIVIDUAL BOX						DETAIL	LENGTH					
9055	9055-BX	10A at 12V DC	SPST	2	On-Off	Normally On	Shaft	1/2"	2 Screw	Plated Steel	Silver	7/16"-20 thread, 7/16" long Two Flats for Double-D Mounting	-
9264	9264-BX	10A at 12V DC	SPST	2	On-Off	Normally On	Button	1/2"	2 Screw	Plated Steel	Silver	7/16"-20 thread, 7/16" long Two Flats for Double-D Mounting	-
9264-02	9264-02-BX	10A at 12V DC	SPST	2	On-Off	Normally On	Button	1/2"	2 Screw	Plated Steel	Silver	7/16"-20 thread, 7/8" long Two Flats for Double-D Mounting	-
9003	9003-BX	5A at 12V DC	SPST	2	On-Off	Normally On	Rounded	3/32"	2 Screw	-	Silver	1/2"-20 thread 1/14" long	-
9118	9118-BX	10A at 12V DC	DPST	2	On-Off	Normally On	Button	19/64"	4 Screw	Plated Steel	Silver	7/16"-20 thread, 7/16" long Two Flats for Double-D Mounting	Energizes two circuits simultaneously. Popular for use in school bus stepwell and door control.
91801	91801-BX	10A at 12V DC	DPST	2	On-Off	Normally On	Button	19/64"	4 Blade	Plated Steel	Silver	7/16"-20 thread, 7/16" long Two Flats for Double-D Mounting	Energizes two circuits simultaneously. Popular for use in school bus stepwell and door control.
91811	91811-BX	10A at 12V DC	SPST	3	On-Mom Off-Mom On	Normally On	Shaft	23/64"	4 Screw	Plated Steel	Silver	7/16"-28 Thread, 3/4" long One Flat for D Mounting	Designed for 8 Light Warning Systems in School Buses
91800	91800-BX	10A at 12V DC	-	3	Mom Off- On-Pull Off	Normally On	Rounded	7/32" On 3/4" Off	2 Screw	Plated Steel	Silver	7/16"-20 thread, 7/16" long Two Flats for Double-D Mounting	Designed for 8 Light Warning \ Systems in School Buses. Pull out feature permits circuit to be shut off manually when the door must remain open and operation is not required
91812	91812-BX	5A at 12V DC	SPST	2	On-Off	Normally Grounded	Rounded	33/64"	1 Blade	Plated Steel	Silver	7/16"-20 thread, 7/16" long Two Flats for Double-D Mounting	Self Grounded

10

Momentary Door Switches

Door Momentary Switches with Faceplates

Additional information: littelfuse.com/Door-Switches



PART NUMBERS		RATING	POLE & THROW	ACTION	NORMAL POSITION	ACTUATOR			TERMINALS	CASE	CONTACTS	MOUNTING
BULK	INDIVIDUAL BOX					DETAIL	LENGTH	DIA.				
9001	9001-BX	5A at 12V DC	SPST	On-Off	Normally On	Rounded	7/16"	45/64"	2 Screw	Plated Steel	Silver	Two 9/64" Ø Mounting Holes 1-3/8" on Center
9270	9270-BX					Round Black Rubber Cap	.436"	.70"	2 Blade			Two 9/64" Ø Mounting Holes 1-3/8" on Center
9087	9087-BX					2 Screw	Four 3/16" Ø Mounting Holes 1-3/8" and 2-1/16" on Center					
9270-01	9270-01-BX					2 PVC Coated 8" Wire Leads	Two .144" Ø Mounting Holes 1-1/2" on Center					

Normally Grounded Door Momentary Switches

Additional information: littelfuse.com/Door-Switches



PART NUMBERS		RATING	POLE & THROW	ACTION	NORMAL POSITION	ACTUATOR			TERMINALS	MOUNTING	REPLACES
BULK	INDIVIDUAL BOX					DETAIL	LENGTH	PRESSURE			
9251	9251-BX	5A at 12V DC	SPST	On-Off	Normally Grounded	Button	7/16"	35 oz	1 Female Bullet	5/16"-18 self-tapping thread, 1/2" long	Chrysler: 1571542, 1594751, 1688514, 1838957 GMC: 4882978, 6276718 Motorcraft: SW-690
91823	91823-BX	5A at 12V DC	DPST	On-Off	Normally Grounded	Button	3/16", self adjusting to 1/4"	7 lbs	2 Blade	3/8"-24 thread, 7/32" long	AMC: "3631896, 3662814 Chrysler: 2497590, 2889084 GMC: 9852254, 20603498 Motorcraft: SWG-1115

Push-Pull, Rotary & Foot Switches

Push-Pull switches operate by pushing or pulling the actuator depending on the configuration of the switch. Rotary switches are activated by a manual rotation of the actuator into two or three positions. Foot switches are mounted on or through the floorboard for hands free operation of the application.

What is Dynamic Parking?

Switch engineers call the feature 'dynamic parking' when the windshield wiper switch actively returns the wiper to home position, rather than waiting until the cycle reaches home.

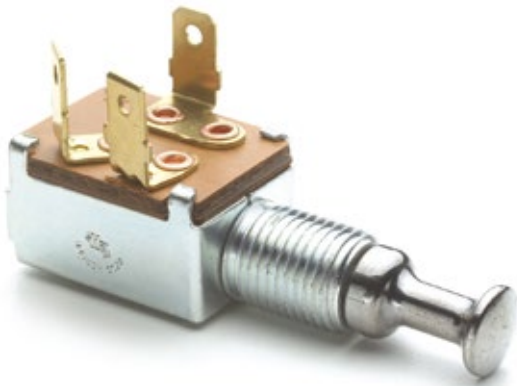

Push-Pull Switches

One and Two Circuit Push-Pull Switches

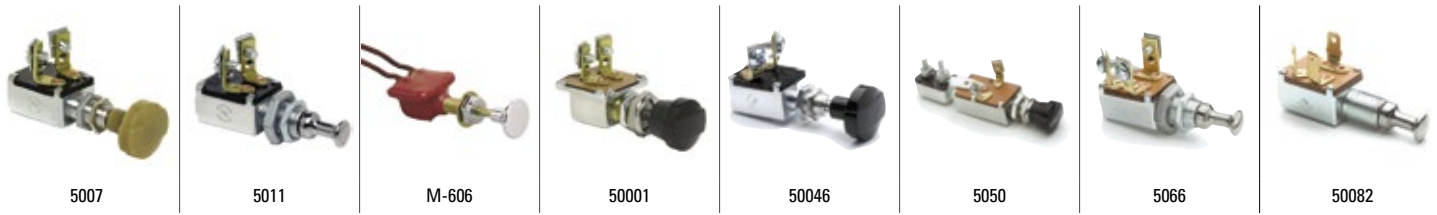

PART NUMBERS			VOLTAGE	RATING	CONFIGURATION	TYPE	NORMAL POSITION	ACTUATOR KNOB	TERMINALS	CONTACTS	HOUSING	MOUNTING STEM		NOTES
BULK	INDIVIDUAL BOX	RETAIL CLAMSHELL										MATERIAL	SIZE	
5007	5007-BX	5007-BP	6-36V DC	10A at 12V DC	SPST	Off-On	Normally Off	Tan Plastic (10-32 Metal Thread)	2 Screw	Copper	Plated Steel	Aluminum	3/8"-32 thread 5/8" long	
5011	5011-BX	—	6-36V DC	10A at 12V DC	SPST	Off-On	Normally Off	Chrome-Plated	2 Screw	Copper	Plated Steel	Steel	1/2"-20 thread 5/8" long	
50070	50070-BX	—	6-36V DC	10A at 12V DC	SPST	Off-On	Normally Off	Chrome-Plated	2 Blade	Silver	Plated Steel	Steel	1/2"-20 thread 5/8" long	
M-606	M-606-BX	M-606-BP	6-36V DC	10A at 12V DC	SPST	Off-On	Normally Off	Chrome-Plated Brass (10-32 Thread)	2x Insulated Copper Wires (12" long)	Copper	Brass - PVC Coated	Brass	—	
50001	50001-BX	—	6-36V DC	10A at 12V DC	SPST	Off-On	Normally Off	Black Plastic (10-32 Metal Thread)	2 Screw	Silver Laminated	Plated Steel	Brass	1/2"-20 thread 5/8" long	
50002	50002-BX	—	6-36V DC	20A at 12V DC	SPST	Off-On	Normally Off	Integral Chrome-Plated Brass	2 Screw	Silver Laminated	Plated Steel	Brass	1/2"-20 thread 5/8" long	
50066	50066-BX	—	6-36V DC	20A at 12V DC	SPST	Off-On	Normally Off	Black Plastic (10-32 Metal Thread)	2 Screw	Silver Laminated	Plated Steel	Brass	1/2"-20 thread 5/8" long	O-Ring Seal in Stem & Gasket Sealed Terminal Insulator
50046	50046-BX	—	6-36V DC	10A at 12V DC	SPST	On-Off	Normally On	Black Plastic (10-32 Metal Thread)	2 Screw	Copper	Plated Steel	Aluminum	3/8"-32 thread 5/8" long	
5050	—	—	6-36V DC	20A	DPST	On-Off	Normally Off	Black Plastic (10-32 Metal Thread) Imprinted: Lights	2 Screw & 1 Stud	Silver	Plated Steel	Steel	1/2"-20 thread 5/8" long	Includes 30A Circuit Breaker
5066	5066-BX	—	6-36V DC	10A at 12V DC	SPDT	Off- On circuit 1 - On circuit 2	—	Integral Chrome-Plated	3 Screw	Copper	Plated Steel	Steel	1/2"-20 thread 5/8" long	Energize two independent circuits alternately from a common feed
50082	50082-BX	—	6-36V DC	8A at 12V DC	SPDT	Off- On circuit 1 - On circuit 2	—	Integral Chrome-Plated	3 blade	Copper	Plated Steel	Steel	1/2"-20 thread 5/8" long	Energize two independent circuits alternately from a common feed

Specialized Push-Pull Switches

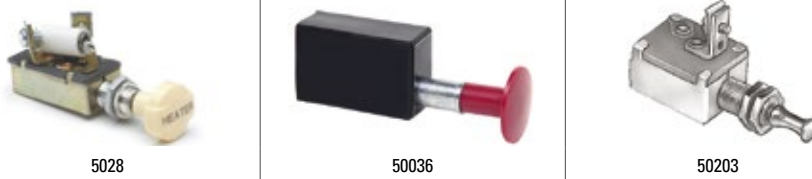

PART NUMBERS			VOLTAGE	POSITIONS	TYPE	ACTUATOR KNOB	TERMINALS	CONTACTS	HOUSING	MOUNTING STEM		NOTES
BULK	INDIVIDUAL BOX	RETAIL CLAMSHELL								MATERIAL	SIZE	
58028	—	—	12V DC	3	Off-Hi-Lo	Ivory Plastic (10-32 Metal Thread) Gold Imprinted: Lights	2 Screw	Copper	Plated Steel (1-13/16" x 1-19/32" x 1/2")	Steel	7/16"-28 thread 5/16" long	Heater Switch 3 ohm Coil Resistance
50036	50036-BX	50036-BP	12V DC	2	On-On (DPST)	Red Plastic 1-1/4" Ø	3 Female Bullet	Copper	Zinc with Rubber Boot	—	—	Two-Speed Axle Switch For mounting on gear shift lever
50203*	—	—	10A at 12V 36V DC max	2	In-Off (Magneto Switch Grounded) Out-Run (Magneto Switch Open)	Integral Nickel Plated	1 Screw	Copper	Plated Steel	Aluminum	3/8"-32 thread 5/8" long	Magneto Switch, Out-Run

*Special Order Item

Push-Pull Headlamp Switches

- Three knob pull positions: In – Mid – Out
- In = Headlamps Off; Mid = Parking Lights and Tail Lights On
- Out = Headlights and Tail Lights On



Additional information: littelfuse.com/PushPullSwitches



PART NUMBERS		RATING PER CIRCUIT	POSITIONS	TYPE	ACTUATOR		TERMINALS	CONTACTS	HOUSING	MOUNTING STEM	NOTES
BULK	INDIVIDUAL BOX				KNOB	IMPRINT					
7124	7124-BX	15A at 12V DC	3	In-Mid-Out	Black Plastic	Lights	4 Screw	Copper	Plated Steel	7/16"-28 thread	-
72100	72100-BX	20A at 12V DC		In-Mid-Out	Black Plastic	Lights	4 Screw	Silver	Diecast	7/16"-28 thread	O-Ring Seal in Stem & Gasket Sealed Terminal Insulator
7152	7152-BX	15A at 12V DC		In-Mid-Out	Ivory Plastic	Lights	4 Screw	Silver	Plated Steel	3/8"-24 thread	-
7157	7157-BX	30A at 12V DC with Breaker		In-Mid-Out	Ivory Plastic	Lights	3 Screw	Silver	Plated Steel	7/16"-28 thread	Includes 30A Circuit Breaker
7127	7127-BX	20A at 12V DC with Fuse		In-Mid-Out	Black Plastic	Lights	4 Screw	Copper	Plated Steel	7/16"-28 thread	Includes 20A Glass Fuse
71092	71092-BX	15A at 12V DC with Internal Breaker		In-Mid-Out	None	None	8 Blade†	-	Plated Steel	7/16"-28 thread	4.5 Ohm with Internal 15A Circuit Breaker
71092-02	71092-02-BX	15A at 12V DC with Internal Breaker		In-Mid-Out	None	None	8 Blade†	-	Plated Steel	7/16"-28 thread	4.5 Ohm with Internal 15A Circuit Breaker
7112	7112-BX	10A at 12V DC	4	In-Mid1-Mid2-Out	Tan Plastic	Lights	5 Screw	Copper	Plated Steel	3/8"-24 thread	-

†Accepts Delphi 2977645 or 2984169



Rheostat Switches

Ceramic insulator with embedded coil for effective heat dissipation.

Additional information: littelfuse.com/RotarySwitches

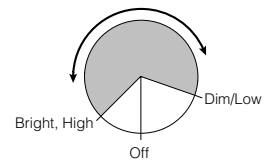

PART NUMBERS		VOLTAGE	RESISTANCE	POSITIONS	ACTUATOR		TERMINALS	HOUSING	MOUNTING STEM	DIMENSIONS
BULK	INDIVIDUAL BOX				KNOB	IMPRINT				
7493	7493-BX	12V DC	8 Ohms	3	Black Plastic Bar Knob	-	2 Screw	Plated Steel	7/16"-28 thread 15/32" long	1.32"Ø .88" long (33.5mm Ø 22.4mm long)
7493-07*	-	12V DC	8 Ohms	3	Black Plastic Bar Knob	Panel Lamps		Plated Steel		
7496	-	12V DC	8 Ohms	3	Black Plastic Bar Knob	-		Plated Steel		
7496-04	7496-04-BX	12V DC	8 Ohms	3	Black Plastic Bar Knob	Panel Lamps	2 Blade	Plated Steel		

*Special Order Item

Universal Rotary Switches

In a full range of styles and circuitries for lighting, ignition and similar applications.

- For forward-reverse operation of a motor, to give a motion such as Up/Down, Left/Right, In/Out, Rotate/Counter-rotate
- Suitable for control of tailgates, winches, windlasses, snowplows and other applications

Additional information: littelfuse.com/RotarySwitches

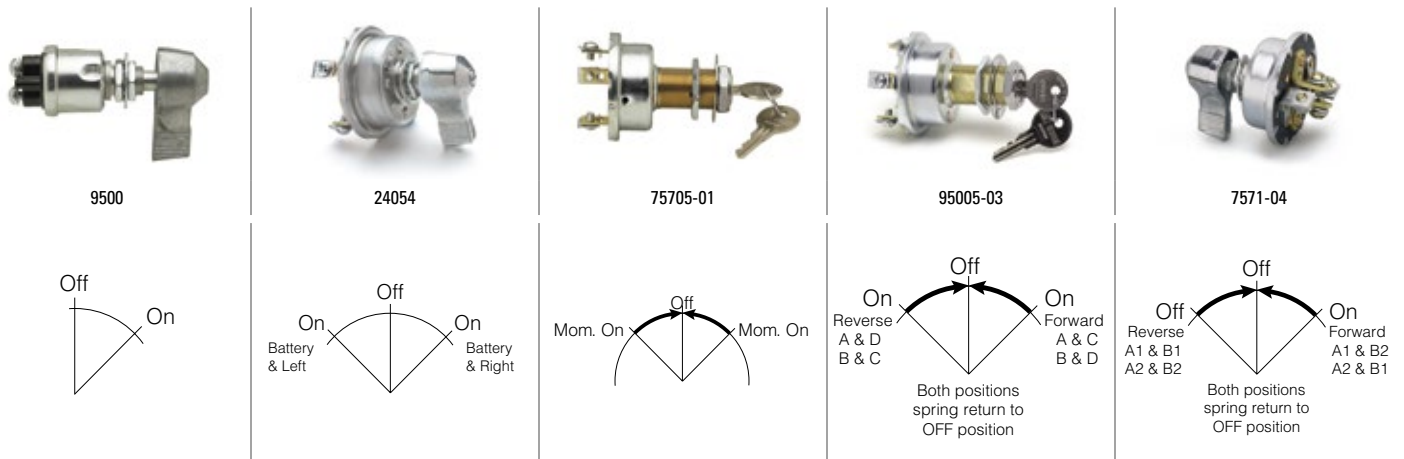

PART NUMBERS		RATING	CONFIGURATION	POSITIONS	SWITCH TYPE	TYPE	ACTUATOR	TERMINALS	HOUSING	MOUNTING STEM	NOTES
BULK	INDIVIDUAL BOX										
9500	9500-BX	10A at 12V DC	SPST	2	–	Off-On	Lever	2 Screw	Plated Steel	½"-20 thread	Compact Case
24054*	–	10A at 12V DC	SPST	–	–	On1-Off-On2	Lever	3 Screw	Plated Steel	½"-20 thread	
75705-01	75705-01-BX	10A at 12V DC	–	3	Momentary	Mom On1-Off-Mom On2	Key with Coded Tumbler Lock	3 Screw	Plated Steel	13/16"-24 thread	Internal O-Ring Seal; Spring Return to Off from Both Positions
90005-03	90005-03-BX	15A at 12V DC	DPDT	–	Reversing	Off (Reverse)-Off-On (Forward)	Key with Coded Tumbler Lock	4 Screw	Plated Steel	13/16"-24 thread	O-Ring Seal in Stem
75712-04	75712-04-BX	–	–	–	Reversing	Off (Reverse)-Off-On (Forward)	Lever	4 Screw	Plated Steel	–	Silver Contacts



Heater-Defroster Switches

Coil embedded in ceramic insulator for effective heat dissipation.

PART NUMBERS		VOLTAGE	RESISTANCE	POSITIONS	TYPE	ACTUATOR	TERMINALS	HOUSING	MOUNTING HOLE
BULK	INDIVIDUAL BOX								
68362	68362-BX	12V DC	3 Ohms	4	Off-High-Medium-Low	Black Plastic Bar Knob	2 Screw	–	5/8" Through-Hole
68363	68363-BX	24V DC	6 Ohms						

*Special Order Item

Foot Switches

Foot Operated Headlamp Dimmer Switches

Depress-release for low beam, depress-release for high beam. Corrosion-resistant diecast metal housings, moisture-repellent insulators.

Additional information: littelfuse.com/FootSwitches



7700



7786



7787



7702



7762

PART NUMBERS		CONFIGURATION	TYPE	TERMINALS	CONNECTOR	HOUSING	MOUNTING		STEM SIZE	REPLACES PART NUMBERS
BULK	INDIVIDUAL BOX						TYPE	HOLES		
7700	7700-BX	SPDT	On-On	3x 16 AWG (5.75" long)	-	PVC Coated Diecast		3x 1/4"-20 tapped holes 3/4" and 1-3/4" on centers	27/32" Ø	-
7786	7786-BX			3 Screw	-	Diecast	Through-Floorboard	3x 1/4"-20 tapped holes 3/4" and 1-3/4" on centers	1-1/16" Ø	Delco 1997014, D-805
7787	7787-BX			3 Screw	-	Diecast		2x 1/4"-20 tapped holes 1-3/4" on centers	7/8" Ø	AMC 803870, 811681, Chrysler 1689512 Delco A-800 Ford A8AZ-13A024A, 7RA 8A-13532 Motorcraft SW-256, 260
7762	7762-BX			3 Blade	30155	Diecast	On-Floorboard	2x 9/32"Ø holes 1-3/4" on centers	-	AMC 5457282, GMC 5834446, 578005, 1539288 Delco 1997028, 1997031, 1997035, 1997037, 1997040, 1997043, D-803, D-804, D-808, D-809, D-810



7785



7792

Foot Operated Turn Switches

Depress to On, spring return to Off. Two switches are needed for left and right turn signals. Plastic-coated, providing protection against moisture, dust and roadsplash.

Additional information: littelfuse.com/FootSwitches

PART NUMBERS		CONFIGURATION	TYPE	NORMAL POSITION	TERMINALS	HOUSING	MOUNTING		STEM SIZE	NOTES
BULK	INDIVIDUAL BOX						TYPE	HOLES		
7785	7785	SPST	Off-On	Normally Off	2x Wire Leads	Diecast PVC Coated	Through-Floorboard	3x 1/4"-20 tapped holes 3/4" and 1-3/4" on centers	7/8" Ø	Sealed
7792	7792	SPST	Off-On	Normally Off	2 Screw	Diecast PVC Coated	Through-Floorboard	3x 1/4"-20 tapped holes 3/4" and 1-3/4" on centers	7/8" Ø	Sealed



9060



9183

Foot Operated Starter Switches

Off-On, normally Off. Depress to On, spring return to Off.

Additional information: littelfuse.com/FootSwitches

PART NUMBERS		CONFIGURATION	TYPE	NORMAL POSITION	TERMINALS	MOUNTING		PLUNGER	NOTES	
BULK	INDIVIDUAL BOX					TYPE	HOLES			
9060	9060-BX	SPST	Off-On	Normally Off	2x 5/16"-24 studs with hexnuts & washers	Through-Floorboard	2x 9/32"Ø holes 1-3/4" on centers	1.83" Long	Autolite SW-40001 (15-47), 15-50, 401A, 4002, 4005, 4010, 4015 (15-51)	Delco D900 (405C)
9183	9183-BX	SPST	Off-On	Normally Off	2x 5/16"-24 studs with hexnuts & washers	Through-Floorboard	2x 9/32"Ø holes 1-3/4" on centers	1" Long	Autolite SW-4012 (15-49)	Delco 1996478

Rotary Headlamp Switches

Headlamp Dimmer Switches

- For variable intensity of control of panel and interior vehicle lighting only
- For use in negative ground systems
- Black plastic knob with metal insert and set screw
- Knob imprinted in white with SAE variable symbol
- Diecast case: 1 9/16" Ø (39.7mm) by .883" (22.4mm) long

Additional information: littelfuse.com/RotarySwitches



74600-02



74601-01

PART NUMBERS			RATING	DUTY CYCLE	CONNECTOR	CASE		MOUNTING
BULK	INDIVIDUAL BOX	RETAIL CLAMSHELL				MATERIAL	DIMENSIONS	
74600-02	-	74600-02-BP	4A at 12V DC	0-100%	3 wire (Load, Battery & Ground) Delphi 2984378 connector on 3" (76.2mm) leads	Diecast	1 9/16" Ø x .883" 39.7mm Ø x 22.4mm	7/16"-28 thread .45" (11.4mm) long
74601-01	74601-01-BX	74601-01-BP	7A at 12V DC	1-99%	2 wires (Load & Battery) 1 25/32" (45.2mm) long	Diecast	1 9/16" Ø x .883" 39.7mm Ø x 22.4mm	7/16"-28 thread .45" (11.4mm) long
74603	74603-BX	-	6A at 12V DC	1-99%	2 wires 2" (50.8mm) long two AMP connectors (load 480054-3, battery 480053-3)	Diecast	1 9/16" Ø x .883" 39.7mm Ø x 22.4mm	7/16"-28 thread .45" (11.4mm) long

Rotary Headlamp Switches

Additional information: littelfuse.com/RotarySwitches



PART NUMBERS		RATING PER CIRCUIT	POSITIONS	ACTUATOR		TERMINALS	CONTACTS	HOUSING	MOUNTING STEM	NOTES
BULK	INDIVIDUAL BOX			KNOB	IMPRINT					
72079-01	72079-01-BX	20A at 12V DC	4	Black Plastic	SAE Headlight Symbol	5 Screw	Silver	Plated Steel	5/8"-32 thread	O-Ring Seal in Stem

Rotary Wiper Switches

Electronic Windshield Wiper Switches

Universal application. For stem- or bracket-mounting. 15/32"-32 thread mounting stem, with keyway.

- Intermittent delay feature for permanent magnet electric wiper motors
- Negative ground only
- Four positions: Off/Park - Intermittent Range - Low - High
- 7/16"-28 x .45" (11.3mm) mounting stem unless noted otherwise
- Round black plastic, white imprinted knob with metal insert and set screw included unless noted otherwise
- Controls single motor unless noted otherwise
- Conforms to SAE J1455, SAE J112a, and SAE J234

Additional information: littelfuse.com/WiperSwitches

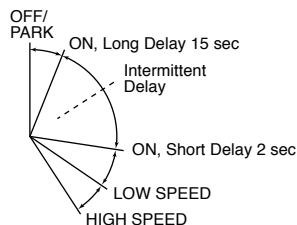

PART NUMBERS			VOLTAGE	POSITIONS	CONNECTOR	CASE		DYNAMIC PARKING	PUSH-TO-WASH	NOTES
BULK	INDIVIDUAL BOX	RETAIL CLAMSHELL				MATERIAL	DIMENSIONS			
75600	-	-	12V DC	4	Delphi 2965977 8-way female connector	Diecast	2 7/32" x 2 7/32" x 1 13/16" (56.4mm x 56.4mm x 46.0mm)	•	•	
75600-01	75600-01-BX	-	12V DC	4	Delphi 6294544 4-way male and Delphi 2977042 6-way male connectors	Diecast	2 7/32" x 2 7/32" x 1 13/16" (56.4mm x 56.4mm x 46.0mm)	•†		Controls two motors in phase at the same speed
75600-02	75600-02-BX	-	12V DC	4	Delphi 2977042 6-way male connector	Diecast	2 7/32" x 2 7/32" x 1 13/16" (56.4mm x 56.4mm x 46.0mm)	•	•	
75600-04	75600-04-BX	-	12V DC	4	Color-coded leads	Diecast	2 7/32" x 2 7/32" x 1 13/16" (56.4mm x 56.4mm x 46.0mm)	•	•	
75600-05*	-	-	12V DC	4	Delphi 6294544 4-way male and Delphi 2977048 4-way female connectors	Diecast	2 7/32" x 2 7/32" x 1 13/16" (56.4mm x 56.4mm x 46.0mm)	•	•	
75600-07	75600-07-BX	-	12V DC	4	7 pole connector	Diecast	2 7/32" x 2 7/32" x 1 13/16" (56.4mm x 56.4mm x 46.0mm)	•	•	
75602-02*	-	-	24V DC	4	Delphi 6294544 4-way male and Delphi 2977042 6-way male connectors	Diecast	2 7/32" x 2 7/32" x 1 13/16" (56.4mm x 56.4mm x 46.0mm)	•†		Controls two motors in phase at the same speed
75602-04	75602-04-BX	-	24V DC	4	Color-coded leads	Diecast	2 7/32" x 2 7/32" x 1 13/16" (56.4mm x 56.4mm x 46.0mm)	•	•	

† = with or without dynamic parking (based on motor capabilities)

*Special Order Item

Electric Windshield Wiper Switches

Universal application. For stem- or bracket-mounting. 15/32"-32 thread mounting stem, with keyway.

- Intermittent delay feature for permanent magnet electric wiper motors.
- Negative ground only
- Three positions: Off/Park - Low - High
- 7/16"-28 x .45" (11.3mm) mounting stem unless noted otherwise
- Round black plastic, white imprinted knob with metal insert and set screw included unless noted otherwise
- Controls single motor unless noted otherwise

Additional information: littelfuse.com/WiperSwitches



PART NUMBERS			VOLTAGE	POSITIONS	TERMINALS	CASE		DYNAMIC PARKING	PUSH-TO-WASH	NOTES
BULK	INDIVIDUAL BOX	RETAIL CLAMSHELL				MATERIAL	DIMENSIONS			
75212-04	75212-04-BX	-	12V or 24V DC	3	4 blade	Plated steel	1 3/8" Ø x 3/8" (34.9mm Ø x 9.5mm)		•	7/16"-28 x .38" (9.6mm) mounting stem
75217-04	75217-04-BX	-	12V or 24V DC	3	6 blade	Plated steel	1 3/8" Ø x 3/8" (34.9mm Ø x 9.5mm)			7/16"-28 x .38" (9.6mm) mounting stem; controls two motors
75221-06	75221-06-BX	-	12V DC	3	4 blade	Plated steel	1 3/8" Ø x 3/8" (34.9mm Ø x 9.5mm)			7/16"-28 x .38" (9.6mm) mounting stem; Internal 6A circuit breaker
75221-09	75221-09-BX	-	12V DC	3	5 blade	Plated steel	1 3/8" Ø x 3/8" (34.9mm Ø x 9.5mm)		•	7/16"-28 x .38" (9.6mm) mounting stem; Internal 6A circuit breaker
75226	75226-BX	-	12V or 24V DC	3	7 blade	Plated steel	1 3/8" Ø x 3/8" (34.9mm Ø x 9.5mm)		•	7/16"-28 x .38" (9.6mm) mounting stem; controls two motors
75228-03	75228-03-BX	-	12V or 24V DC	3	6 blade	Diecast	1 5/8" Ø (41.3mm Ø)	•	•	
75228-04	75228-04-BX	-	12V or 24V DC	3	5 blade	Diecast	1 5/8" Ø (41.3mm Ø)	•		
75236	75236-BX	-	12V or 24V DC	3	8 blade	Diecast	1 5/8" Ø (41.3mm Ø)	•	•	Controls two motors

Wiper Switch Accessories



81298-02



81298-34

PART NUMBERS		IMPRINT	FACE DIAMETER	MATERIAL
BULK	INDIVIDUAL BOX			
81298-02	81298-02-BX	SAE wiper symbol	1 3/16" Ø	Black plastic
81298-34	81298-34-BX	SAE wiper-washer symbol	1 3/16" Ø	Black plastic

Specialty Switches

Backup Switches

- See table below for replacement suitability
- Normally off, on with plunger depressed, spring return to Off

Additional information: littelfuse.com/BackupSwitches



91113



75125



9052

PART NUMBERS		RATING	POLE & THROW	ACTION	NORMAL POSITION	ACTUATOR	MOUNTING	DETAIL	TERMINALS
BULK	BOXED								
91113	91113-BX	20A at 12V DC	SPST	Off-On	Normally Off	Ball	On vehicle transmission	Spring return to Off	2 screw
75125	72125-BX	–	SPST	Off-On	Normally Off	5" lever	Two 13/64" (5.2mm) Ø mounting holes, 1/2" (12.7mm) on centers	Back-up alarm switch Spring return to Off	2 screw
9052	9052-BX	10A at 12V DC	SPST	Off-On	–	Button-Head 1/2" (12.7mm) long	7/16" (7.9mm) Ø mounting stem, 7/16" –20 (7.9mm) long, with two flats for mounting in double-D hole	Spring return to Off	2 screw

LITTELFUSE PART NUMBER	REPLACES PART NUMBERS
91113	Autocar: 8E-01360 Brockway: 128537 Diamond Reo: 560-65 Kenworth: AT-91-69 Mack: 1MR-1320 Oshkosh: 13320-F1 White: 1743529 Pollak: 21-458
9052	Ford: B9AF, C0AF, 51-A15520A Jeep: 710412, 721028 Motorcraft: SW-410

Neutral Safety Ball Switches

- Spring return to normal position
- Moisture-resistant insulators
- Corrosion-resistant metal housings
- Silver contacts

Additional information: littelfuse.com/NeutralSafetySwitches



9242



9242-01



92102



92107-04



9162-03



9224

PART NUMBERS		RATING	POLE & THROW	NORMAL POSITION	MOUNTING	DETAIL	TERMINALS
BULK	BOX						
9242	9242-BX	35A at 12V DC 20A at 24V DC	SPST	Normally Off	9/16" -18 UNF-2A thread, 5/16" (7.9mm) long	–	2 screw
9242-01	9242-01-BX	35A at 12V DC 20A at 24V DC	SPST	Normally Off	9/16" -18 UNF-2A thread, 5/16" (7.9mm) long	Same as 9242 but with brass gasket/washer	2 screw
92102	92102-BX	35A at 12V DC 20A at 24V DC	SPST	Normally Off	9/16" -18 UNF-2A thread, 21/32" (16.7mm) long	Accepts female blade terminals or Delphi 2962679 2-pole connector	2 button head
92107-04	92107-04-BX	20A at 12V DC	SPST	Normally Off	3/4" -16 UNF-2A thread, 31/64" (12.3mm) long	–	2 screw
9162-03	9142-03-BX	35A at 12V DC	SPST	Normally Off	3/4" -16 UNF-2A thread, 31/64" (12.3mm) long	Gasket on mounting stem	2 female bullet
9224	9224-BX	5A at 12V DC 3A at 24V DC	SPST	Normally On	3/4" -16 UNF-2A thread, 31/64" (12.3mm) long	Aluminum gasket/washer	2 screw

LITTELFUSE PART NUMBER	REPLACES PART NUMBER
9242	International 863187-R91
9242-01	International 863187-R91
9162-03	Massey 181140M94
9224	Clark 224620

Stoplamp Switches

- See table below for replacement suitability

Additional information: littelfuse.com/StoplampSwitches

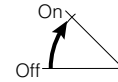

8626



8629



8645



8715



8487

PART NUMBERS		HYDRAULIC	MECHANICAL	POLE & THROW	NORMAL POSITION	DETAIL	MOUNTING	TERMINALS	NOTES
BULK	BOXED								
8626	8626-BX	•		SPST	Normally Off	–	1/8" -27 thread 11/32" (8.73mm) long	2 6-32 screw	Operates at 60-120 psi (414-827 kPa); NPTF dry-seal thread for use without sealant
8629	8629-BX	•		SPST	Normally Off	–	1/8" -27 thread 11/32" (8.73mm) long	2 male bullet	Operates at 60-120 psi (414-827 kPa); NPTF dry-seal thread for use without sealant
8645	–		•	SPST	Normally On	Plunger 11/32" long	1/2" -20 thread 3/8" long	2 blade	Spring return to normal position
8715	8715-BX		•	SPST	Normally On	Moisture-resistant plastic body	1/2" Ø 1 5/32" long	2 blade	Spring return to normal position.
8487	8487-BX		•	SPST	Normally On	Lever is 2 7/8" overall length	Tapped 10-32 mounting holes 5/8" on centers	2 bullet	Spring return to normal position.

LITTELFUSE PART NUMBER	REPLACES PART NUMBERS
8626	Delco: 476S, 4760 FWD: 4760, 4765 GMC: 403936, 476592, 1316600 Ford: 100810B, 510C Mack: 5CG-114, 11MR-1152 Motorcraft: SW-311 Wagner: FC-1201, FC5106 White: 58012-F, 443106, 1319522
8629	AMC: 300356, 3145198, 3192194, 4488306 Delco: 4766, 4733, D850 Ford: B8A, B9SF, C1AZ-13480A, GMC: 1320938, 1328118, 1997725 Jeep: 70034, 201466, 647801 Motorcraft: SW-24, Wagner: FC-6780, FC-7715, 179-318, AC5812W
8715	AMC: 3189147, 3194569, 4488295, 5352620, 9770419 Chrysler: 2809033 Delco: D864, D866, D868, D873, U850, U851, U852, D885 Ford: C8ZZ-13480A, C7TZ, D2TZ-13480B International: 312739C91, 358560C91 GMC: 536289, 1261219, 1362835, 959, 1993509, 1998192, 196, 667, 3631535, 3889606, 3889607, 3952426, 9772188, 9776994, 14074323, 25524844 Motorcraft: SWG-535, SW-691A, SW-1512 VW: 175957656A, Wagner: FC-32200, FC-32085, FC-66780
8487	Delco: D852, D854, DR-2401 GMC: 1997913, 1997921 Motorcraft: SWG-318, 319 Wagner: FC-21632

Neutral Safety and Backup Lamp Switch Accessories

For Neutral Safety and Back-up Lamp Switches. Molded of durable PVC to resist moisture and dirt. Internal ring forms a seal with the groove around the switch housing.



83377

PART NUMBERS		DETAIL	MOUNTING
BULK	BOX		
83377	83377-BX	Protective boot for switches with 1 1/8" hex housing. Part Numbers: 9224, 9242, 9242-07, 92102, 92103, 92105, 92107-04.	Internal ring forms seal with switch housing groove

Vehicle Connectors



Heavy duty sockets, plugs and assemblies that withstand the rigors of trucking in dust, dirt, rain and snow, heat and cold, yet maintain electrical continuity between tractor unit and trailer.



Best Practices for Connectors

Properly installed tractor-trailer connectors are critical to the safe performance of a rig so connectors are routinely subjected to vibration, extreme weather conditions, as well as mechanical forces. We highly recommend that a trained technician performs the installation. It is the responsibility of the end-user to take into account the mounting location and environment, conductor type, size, flexibility and other installation parameters.

Review the assembly procedure before assembly. A common error is to not slide a clamp, boot or housing onto the cable before connecting the wires. Recommended tools: screwdriver (preferably with torque limiter); soldering iron (preferably a solder pot), solder and flux; wire stripper and cutter; and ruler. Cut the cable, and strip the jacket to the recommended length. Strip the wires to the recommended length, and tin them. Maintain a tight strand bundle before tinning, so that there are no loose strands. Re-tin if necessary. This makes it easier to insert the wires into the terminal, and helps to properly position the tinned strands at the right depth.

Slide the housing, spring coil or boot over the cable. Properly insert and position the tinned conductor into each terminal. Locate the tinned portion under the terminal screw before tightening the screw. Tighten the termination screws to the appropriate torques.

Inspect the terminated connection for cut or loose strands, fragments of wire insulation between the terminal/conductor connection, bent terminals, loose or stripped terminal screws and other visible problems.

Check that the correct connections have been made, by re-checking that the conductor jacket color matches the insulator coding.

Carefully slide the insulator into the connector housing, making sure that the insulator is fully seated. Don't twist or lever the terminated conductor after it has been inserted and locked into the insulator. This may damage the terminal and put stress on the terminated connection. Finally tighten the housing screw or cable clamp.

In order to keep a plug clean when not inserted in a socket, we recommend the use of the 11750 Stor-A-Way Plug Holder.

12300 & 12301 - 13-Pole Connectors

The 13-pole sockets and plugs provide six additional tractor-trailer circuits within the dimensions of traditional 7-pole connectors. The connectors are adaptable to a wide variety of wiring combinations, including multiplexed circuits. 13-Pole connectors surpass SAE J560b performance standards, by conforming to interchangeability between 7-pole and 13-pole connectors. The connectors are a bright yellow so that the 13 pole configuration is easily identifiable. They are constructed of robust glass-filled plastic housings that cannot rust or corrode. The ground terminals accept up to 8AWG wire, 7 pole terminals up to 10AWG, smaller 6 pole terminals up to 14AWG.



12300



12301

12300, Socket

- Gasket-sealed socket door is spring-loaded and locks onto the plug.
- Rain hood extends beyond the pins to protect the interior. The 5° downward pitch drain channel inside the socket reduces water retention.
- Three mounting holes on the flange: .33" (8.4mm) diameter, 2.93" (74.6mm) on centers.
- Includes six 31784 crimp-on connectors to mate with the six smaller pole terminals.

12301, Plug

- Plug locks into the socket, utilizing the spring-loaded socket door.
- Spring-grip contacts have self-adjusting spring bands to maintain long-term uniform electrical contact with socket pins. They also feature strain relief and grommet seals to isolate the contacts from mechanical strain and provides water protection.
- Cable retainer maintains secure cable connection.
- O-ring at the plug end prevents water from reaching the contacts.
- Includes six 31784 crimp-on connectors to mate with the six smaller pole terminals.

Additional information: littelfuse.com/VehicleConnectors

PART NUMBERS			POLES	TYPE	MATERIAL	COLOR	TERMINALS		MOUNTING HOLES	NOTES
BULK	INDIVIDUAL BOX	RETAIL					PIN TYPE	MATERIAL		
12300	12300-BX	–	13	Socket	Glass-Filled Plastic	Yellow	Solid	Brass	3	Spring Loaded Door
12301	12301-BX	–	13	Plug	Glass-Filled Plastic	Yellow	Solid	Brass	–	O-ring in plug end



81356

81356 - Protective Boot for 3-Bolt Flange Sockets

Protect against road splash, dirt and moisture. Fits over the back of the flange, and covers the terminal connectors. Designed for 12310 7-pole socket and 12300 13-pole socket.

PART NUMBERS			POLES	MATERIAL	NOTES
BULK	BOXED	RETAIL			
81356	81356-BX	–	7 & 13	Rubber	Fits Sockets: 12300 and 12310

Typical RV 7-Pole Wiring Color Codes

WIRE COLOR	FUNCTION
White	Ground
Black	Auxiliary power/battery charge
Yellow	Auxiliary
Red	Left turn and brake lights
Green	Taillights and clearance lights
Brown	Right turn and brake lights
Blue	Electric trailer brakes

SAE Coding Convention for 7-Pole Connectors

WIRE COLOR	CONDUCTOR NUMBER	LITTELFUSE TERMINAL MARKING	FUNCTION
White	1	W	Ground return to towing vehicle
Black	2	BK	Clearance, side marker, and identification lamps
Yellow	3	Y	Left turn signal and hazard lamps
Red	4	R	Stop lamps and antilock device
Green	5	G	Right turn signal and hazard lamps
Brown	6	BR	Tail and license plate lamps
Blue	7	BL	Continuous ABS power/Auxiliary

Tractor-Trailer Connectors

7-Pole Connector Sockets

Sockets and plugs conform to ATA, RCCC (RP-102), SAE (J560b), FMVSS-121, FIEI TTMA (RP 40-73) standards or recommendations, and are compatible with other standard (J560b) connectors.

Ground terminal accepts wires up to 8AWG, other terminals up to 10AWG. Solid brass contacts are aligned to assure proper contact and minimal voltage drop. Wiring codes are embossed on the insulator.

The door is spring-loaded and fits over a mating ridge on the socket face to minimize penetration of dirt and moisture. Housings are constructed from corrosion-resistant diecast metal or rugged glass-filled plastic. Contacts are either self-grounding or insulated.

Additional information: littelfuse.com/VehicleConnectors

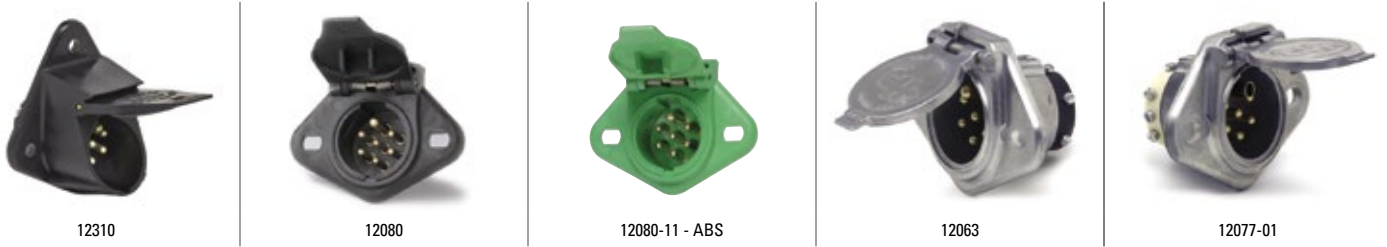

PART NUMBERS			POLES	MOUNTING HOLES	MATERIAL	COLOR	TERMINALS		DIMENSIONS		SPRING LOADED DOOR	NOTES
BULK	INDIVIDUAL BOX	RETAIL					PIN TYPE	MATERIAL	MOUNTING FLANGE	THROUGH-HOLE		
12310	12310-BX	–	7	3	Glass-Filled Plastic	Black	Solid	Brass	0.33" (8.4mm) Ø 2.93" (74.6mm) on centers	–	•	Gasket-Sealed with Rain Hood
12080	12080-BX	–	7	2	Glass-Filled Plastic	Black	Solid	Brass	0.488" x 0.328" (12.4x8.3mm) oval 2.93" (74.6mm) on centers	2" (50.8mm) Ø	•	Insulated
12080-01	12080-01-BX	–	7	2	Glass-Filled Plastic	Black	Split	Brass	0.488" x 0.328" (12.4x8.3mm) oval 2.93" (74.6mm) on centers	2" (50.8mm) Ø	•	Insulated
12080-11	12080-11-BX	–	7	2	Glass-Filled Plastic	Green	Solid	Brass	0.488" x 0.328" (12.4x8.3mm) oval 2.93" (74.6mm) on centers	2" (50.8mm) Ø	•	Door marked "Trailer ABS"
12063	12063-BX	–	7	2	Diecast Metal	–	Solid	Brass	0.488" x 0.328" (12.4x8.3mm) oval 2.93" (74.6mm) on centers	2" (50.8mm) Ø	•	Self-Grounding
12063-01	12063-01-BX	–	7	2	Diecast Metal	–	Split	Brass	0.488" x 0.328" (12.4x8.3mm) oval 2.93" (74.6mm) on centers	2" (50.8mm) Ø	•	Self-Grounding
12077-01 [†]	12077-01-BX	–	7	2	Diecast Metal	–	zx spring Grip Female 6x Solid Male	Brass	0.488" x 0.328" (12.4x8.3mm) oval 2.93" (74.6mm) on centers	2" (50.8mm) Ø	•	For ISO-Type Polarized ground terminal - Insulated Mates with 11100-02 and 11100-01

[†] Polarized ground terminal, insulated. Replacement for ISO 3731-1976 (E) road vehicles, type 24S (supplementary).

Typical RV 7-Pole Wiring Color Codes

WIRE COLOR	FUNCTION
White	Ground
Black	Auxiliary power/battery charge
Yellow	Auxiliary
Red	Left turn and brake lights
Green	Taillights and clearance lights
Brown	Right turn and brake lights
Blue	Electric trailer brakes

SAE Coding Convention for 7-Pole Connectors

WIRE COLOR	CONDUCTOR NUMBER	LITTELFUSE TERMINAL MARKING	FUNCTION
White	1	W	Ground return to towing vehicle
Black	2	BK	Clearance, side marker, and identification lamps
Yellow	3	Y	Left turn signal and hazard lamps
Red	4	R	Stop lamps and antilock device
Green	5	G	Right turn signal and hazard lamps
Brown	6	BR	Tail and license plate lamps
Blue	7	BL	Continuous ABS power/Auxiliary

7-Pole Connector Plugs – High Performance



12311

Ground terminal accepts wires up to 8AWG, other terminals up to 10AWG. Cable protectors are constructed of plated steel, and provide strain relief and protection against abrasion.

- High-Performance Plug Surpasses SAE J560b performance standards. Superior environmental protection gives extended product life. Black glass-filled plastic housing cannot rust or corrode
- Plug locks onto opening on spring-loaded socket door. Spring-grip contacts have self-adjusting spring bands to maintain long-term uniform electrical contact with socket pins. O-ring at the plug end prevents water from reaching the contacts.
- Strain relief and grommet seal isolates the contacts from mechanical strain, and provides extra moisture protection. Cable retainer maintains secure cable connection. Replaceable interior.
- Connects with all SAE J560b sockets, and Littelfuse brand 13-pole sockets.

Additional information: littelfuse.com/VehicleConnectors

PART NUMBERS			POLES	CABLE PROTECTOR	MATERIAL	COLOR	O-RING
BULK	INDIVIDUAL BOX	RETAIL					
12311	12311-BX	–	7	–	Glass-Filled Plastic	Black	•

7-Pole Connector Plugs – Quick Release Interiors



12091/12092

Quick Release Plug Interiors can be readily removed by loosening the single set screw in the cable clamp, and then depressing on the spring clip release with a screwdriver. The interior then readily slides out. The interior slides back into the housing and locks securely into place with a high-tension metal clip. After the cable clamp is tightened, the plug is ready for use.

- Plated steel cable protectors are available to provide strain relief and protection against abrasion
- Ground terminal accepts wires up to 8AWG, other terminals up to 10AWG.

Additional information: littelfuse.com/VehicleConnectors



12081/12082

PART NUMBERS			POLES	CABLE PROTECTOR	MATERIAL	COLOR
BULK	INDIVIDUAL BOX	RETAIL				
12091	12091-BX	–	7	–	Diecast Metal	–
12092	12092-BX	–	7	•	Diecast Metal	–
12081	12081-BX	–	7	–	Glass-Filled Plastic	Black
12082	12082-BX	–	7	•	Glass-Filled Plastic	Black

7-Pole Connector Plugs – Spring Grip Electrical Contacts



1255

Spring Grip Electrical Contacts contain a self-adjusting spring band that maintains contact pressure from socket to pin. Greater contact pressure not only gives greater electrical efficiency, but also makes coupling and uncoupling uniform, and minimizes buildup of dirt. In competitive plugs, conventional contacts tend to widen after repeated use. These plugs feature individually sprung sockets to insure maximum contact year after year.

- Plated steel cable protectors are available to provide strain relief and protection against abrasion
- Ground terminal accepts wires up to 8AWG, other terminals up to 10AWG
- Diecast metal housing
- Replaceable interior
- Wiring codes are identified on the insulator
- Cable clamp holds all wires securely

Additional information: littelfuse.com/VehicleConnectors

PART NUMBERS			POLES	CABLE PROTECTOR	MATERIAL	COLOR
BULK	INDIVIDUAL BOX	RETAIL				
1222	1222-BX	–	7	–	Diecast Metal	–
1255	1255-BX	–	7	•	Diecast Metal	–

Tractor-Trailer Connectors

4 & 6 Pole Connector Sockets

Normally used with a trailer where limited functionality (taillights, brake lights) is needed. Ideal for boat trailers, or RVs towing a car on a flatbed trailer. Diecast metal housings. Screw terminals accept up to 12AWG wire. Replaceable interiors.

Brass split-pin contacts are aligned to assure proper contact and minimal voltage drop. Spring-loaded socket doors, plug locks securely into the opening. Wiring codes are identified on the insulator. Two mounting holes on the flange 17/64" (6.7mm) diameter, 2 15/16" (74.6mm) on centers. Mount through 1 3/8" (34.9mm) diameter hole.

Additional information: littelfuse.com/VehicleConnectors



1258



1235



1257/1232

PART NUMBERS			POLES	MOUNTING HOLES	MATERIAL	TERMINALS		DIMENSIONS		SPRING LOADED DOOR	PROTECTIVE HOUSING	NOTES
BULK	INDIVIDUAL BOX	RETAIL				PIN TYPE	MATERIAL	MOUNTING FLANGE	THROUGH-HOLE			
1258	1258-BX	-	6	2	Diecast Metal	Split	Brass	17/67 (6.7mm) Ø 2 15/16" (74.6mm) on centers	1 3/8" Ø (34.9mm) Ø	•		Exposed terminal screws
1235	1235-BX	-		2	Diecast Metal	Split	Brass	17/67 (6.7mm) Ø 2 15/16" (74.6mm) on centers	1 3/8" Ø (34.9mm) Ø	•	•	-
1257	1257-BX	-	4	2	Diecast Metal	Split	Brass	17/67 (6.7mm) Ø 2 15/16" (74.6mm) on centers	1 3/8" Ø (34.9mm) Ø	•		Exposed terminal screws
1232	1232-BX	-		2	Diecast Metal	Split	Brass	17/67 (6.7mm) Ø 2 15/16" (74.6mm) on centers	1 3/8" Ø (34.9mm) Ø	•	•	-

4 & 6 Pole Connector Plugs

Contacts float for best alignment and connection. Cable clamps hold all size cables firmly in place. Cable protectors (where present) are constructed from plated steel, and provide strain relief and protection against abrasion.

Additional information: littelfuse.com/VehicleConnectors



1236



1254



1233



1253

PART NUMBERS			POLES	CABLE PROTECTOR	MATERIAL	TERMINALS		CABLE CLAMPS	NOTES
BULK	INDIVIDUAL BOX	RETAIL				PIN TYPE	MATERIAL		
1236	1236-BX	-	6		Diecast Metal	Split	Brass	•	Exposed terminal screws
1254	1254-BX	-		•	Diecast Metal	Split	Brass	•	
1233	1233-BX	-	4		Diecast Metal	Split	Brass	•	
1253	1253-BX	-		•	Diecast Metal	Split	Brass	•	Exposed terminal screws



11041-06

2-Pole Power Take-Off Connectors

Suitable replacement for connectors in tarping applications. Provides a high-integrity two-circuit path for on- and off-road vehicles and in agricultural applications. Plug latches solidly with the socket cover.

- Vertically-aligned machined brass contacts
- Diecast zinc plug and socket housings with engineering-grade plastic interior
- Terminations accept 6AWG wire
- Polarized connections

Additional information: littelfuse.com/VehicleConnectors



11041-05

PART NUMBERS			POLES	CABLE PROTECTOR	MATERIAL	NOTES
BULK	BOXED	RETAIL				
11041-06	11041-06-BX	–	2	–	Diecast Metal	Gasket-sealed socket keeps out dirt and moisture when not in use
11042-05	11042-05-BX	–	2	•	Diecast Metal	Durable, flexible spring coil protects the cable

1-Pole Power Take-Off Connectors

Diecast metal plug and socket housings with engineering-grade plastic interior provides power to auxiliary equipment. Electrical conductors and connections are designed for maximum efficiency and long life and terminations accept up to 0AWG wire.

- 11041 - Socket: Self-grounding. Solid brass 3/8" (9.5mm) Ø male contact, with insulated tip to prevent short circuits. Rubber boot protects terminals and connections from moisture and dirt. Fits 2" (50.8mm) Ø hole. Two mounting holes on the flange 21/64" (8.6mm) Ø, 2 15/16" (74.6mm) on centers
- 11042 - Plug: With ground return terminal. Brass female contact with spring grip tension provides solid engagement with the mating socket. Cable clamp holds cable firmly in place.

Additional information: littelfuse.com/VehicleConnectors



11041



11042

PART NUMBERS			POLES	TYPE	MATERIAL	CONTACTS
BULK	BOXED	RETAIL				
11041	11041-BX	–	1	Socket	Diecast Metal	Brass
11042	11042-BX	–	1	Plug	Diecast Metal	Brass

Farm Equipment Connectors

Two-pole breakaway unit: plug automatically releases at approximately 20lbs pull. Mate with all connectors of comparable design. Polarized. 20A maximum capacity.

- 1282 - Socket with Mounting Bracket: Plated steel housing. High impact-resistant molded insulator. Brass contacts and brass screw terminals. Stainless steel spring on the cover locks the plug in place. Integral mounting bracket with two .218" (5.6mm) diameter mounting holes, 1.25" (31.8mm) on centers.
- 1283-325, Plug: Plated brass housing. Threaded cable grip.

Additional information: littelfuse.com/VehicleConnectors



1282



1283-325

PART NUMBERS			POLES	TYPE	MATERIAL	CONTACTS	TERMINALS	POLARIZED
BULK	INDIVIDUAL BOX	RETAIL						
1282	1282-BX	–	2	Socket	Plated Steel	Brass	Brass Screw	•
1283-325	1283-325-BX	–	2	Plug	Plated Brass	Brass	Brass Screw	•

Flush-Mount Flanged Socket and Plug Connectors

- Socket: Pivot cover protects against moisture and dust. Polarized. Two .147" (3.73mm) Ø mounting holes, 1/19" (30.23mm) on centers.
- Plug: Molded insulator plug with knurled cap for easy connection of wires. Terminal ID .110" (2.8mm) accepts up to 12AWG stranded wire.



1214

PART NUMBERS			POLES	TYPE	MATERIAL	CONTACTS	TERMINALS	POLARIZED
BULK	BOXED	RETAIL						
1214	-BX	–	2	Socket & Plug	Plated Steel	Brass	–	•

In-Line Universal Connector

Flat profile design provides a robust 7-pole or 12-pole connection. Housings are molded thermoplastic material, resistant to ultraviolet solar radiation. Nickel-plated brass terminals with split contact pins give a positive connection. Insulators between each terminal provide protection from short circuits. Spring-loaded socket lid protects the terminals when not in use. Insulated cable clamp secures the cable, minimizing vibration and strain. Terminal covers are easily removed for access to terminals. Additional information: littelfuse.com/VehicleConnectors

- Circuit Identification:**
- | | | |
|----------------------|---|---------------|
| 1. Left turn signal | 5. Accessory | 9. Accessory |
| 2. Accessory | 6. Brake lights | 10. Ground |
| 3. Ground | 7. Rear-clearance and side marker lamps | 11. Accessory |
| 4. Right turn signal | 8. Accessory | 12. Accessory |



PART NUMBERS			POLES	TYPE	MATERIAL	TERMINALS	WIRE SIZE	NOTES
BULK	INDIVIDUAL BOX	RETAIL						
12400	12400-BX	–	7	Socket	Thermoplastic	Nickel-Plated Brass	14AWG Max	–
12401	12401-BX	–		Plug				–
12500	12500-BX	–	12	Socket	Thermoplastic	Nickel-Plated Brass	Pins 1-7 accept 14AWG max Pins 8-12 accept 8AWG max	Accepts 12- or 7-pole plug
12501	12501-BX	–		Plug				–

Plug & Socket Connectors with Rubber Caps

Polarized to assure proper mating of circuits. Molded insulator bodies. Precision-machined brass contacts. Rubber caps protect connectors. Additional information: littelfuse.com/VehicleConnectors



PART NUMBERS			POLES	TYPE	MATERIAL	CONTACTS	TERMINALS	COLOR	POLARIZED
BULK	INDIVIDUAL BOX	RETAIL							
M-115	M-115-BX	M-115-BP	3	Plug & Socket	Thermoplastic	Brass	Brass Screws	Black	•
M-121	M-121-BX	M-121-BP	2	Plug & Socket	Thermoplastic	Brass	Brass Screws	Black	•

Universal Trailer Connectors

Weatherproof connectors & wire lead assemblies. Polarized to assure proper mating of circuits. Molded bodies. Color-coded 16AWG wire, 6" long (152.4mm). Conductors are properly aligned and bonded into the insulation, to assure minimal voltage drop, and for ease in connecting. Additional information: littelfuse.com/VehicleConnectors



PART NUMBERS			POLES	POLARIZED
BULK	INDIVIDUAL BOX	RETAIL		
11134	11134-BX	11134-BP	4	•
11173	11173-BX	11173-BP	3	•
11172	11172-BX	11172-BP	2	•



11750

11750 - Stor-A-Way Plug Holder

Patented by Littelfuse–Cole Hersee. Designed to keep plugs clean when not in use, and extends life by protecting electrical contacts from dirt and road splash.

For all SAE J560b 7-pole plugs and 13-pole plugs. Spring-loaded for secure locking.

PART NUMBERS			POLES	MATERIAL	NOTES
BULK	BOXED	RETAIL			
11750	11750-BX	–	7 or 13	Heavy duty glass-filled plastic	Fits Plugs: 12311, 1222, 1255, 12091, 12092, 12081, 12082, 12301, 11042 and 11042-05.



1160

1160 - License Holder Tube

Weatherproof tube protects important papers. 5" x 1 1/8" (127.0 x 28.6mm).

PART NUMBERS			MATERIAL			MOUNTING
BULK	BOXED	RETAIL	BODY	CAP	FLANGE	
1160*	–	–	Aluminum	Captive Brass	Brass	Three 3/16" (4.8mm) Ø mounting holes in flange



81192

81192 - Cable Protector

Protects against strain and kinking.

PART NUMBERS			MATERIAL	NOTES
BULK	BOXED	RETAIL		
81192	81192-BX	–	Plated Steel	Fits Plugs: 11042-05, 12081, 12082, 12091, 12092



11178

11178 - Protective Boot for 7-Pole Sockets

Protect against road splash, dirt and moisture. Inner ridge locks over the heads of the terminal screws and to the edge of the casting.

PART NUMBERS			POLES	MATERIAL	NOTES
BULK	BOXED	RETAIL			
11178	11178-BX	–	7	Rubber	Fits Sockets: 12063, 12063-01, 12080, 12080-01, 12080-11, 12077-01 and other 7-pole sockets with similar design



11165



11164

Surface Mounting Socket Accessories

For attachment of 4-, 6-, and 7-pole sockets of standard design (without integral circuit breakers).

- 11165 - Mounting Bracket: Eliminates the need for cutting a hole in the trailer to accept a socket. Mounting hardware included. Center hole is 2" (50.8mm) diameter.
- 11164 - Mounting Gasket: Neoprene gasket for plastic or metal sockets.

PART NUMBERS			TYPE	MATERIAL	NOTES
BULK	BOXED	RETAIL			
11165	11165-BX	–	Bracket	Steel	Mounting hardware included
11164	11164-BX	–	Gasket	Neoprene	Fits Sockets: 12063, 12063-01, 12080, 12080-01

98647 - 13-Conductor Cable

Straight cable, available in 500' lengths. Conductor wires are color-coded for easy recognition. Durable insulation resists abrasion and will not crack or stiffen at -70°F (-57°C)

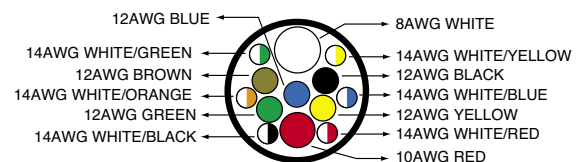

98647

PART NUMBERS		MATERIAL	13 TOTAL WIRE CONDUCTOR SIZES			
500' LENGTH			ONE WIRE	ONE WIRE	FIVE WIRES	SIX WIRES
98647		100% Copper	8AWG	10AWG	12AWG	14AWG

*Special Order Item

Indicator Devices



Indicators are used for remote monitoring or indication of system status. Pilot lights are frequently used as signal indicators for accessories or aftermarket add-ons.

What are the benefits of LEDs?

LED lights are solid-state, so they last longer and may never need servicing. This means that replacement builds are not needed, and time is saved in applications with maintenance personnel.

LEDs are unaffected by on-off cycling, and their brightness does not diminish over time. LEDs can also function over a wider range of temperatures making them ideal for harsh environments from desert conditions to frigid cold temperatures.

LEDs can be safer because they produce less heat. The build up of heat is undesirable because it can create potential fire risks. LEDs operate at a very cool temperature and the lens is not vulnerable to breakage from water-splash.



12V LED Pilot Lights

Rugged light-emitting diode that ensures long hours of service, never needing bulb replacement. Additional information: littelfuse.com/PilotLights



PL-521 Series • 12V LED Pilot Lights

- Approx. 1" bezel, fits 11/16" diameter hole (17.2mm). ¼" blade terminals (screw terminals special order).

PART NUMBERS			RATING	COLOR	TERMINALS	BEZEL SIZE	HOLE SIZE
BULK	BOXED	RETAIL					
PL-521-RC	PL-521-RC-BX	–	12V DC	Red	¼" blade	1"	11/16" Ø
PL-521-AC	PL-521-AC-BX	–	12V DC	Amber	¼" blade	1"	11/16" Ø
PL-521-GC	PL-521-GC-BX	–	12V DC	Green	¼" blade	1"	11/16" Ø



PL-522 Series • 12V LED Pilot Lights

- Approx. 3/4" bezel, fits 5/8" diameter hole (15.9mm). ¼" blade terminals (screw terminals special order).

PART NUMBERS			RATING	COLOR	TERMINALS	BEZEL SIZE	HOLE SIZE
BULK	BOXED	RETAIL					
PL-522-RC	PL-522-RC-BX	–	12V DC	Red	¼" blade	¾"	5/8" Ø
PL-522-AC	PL-522-AC-BX	–	12V DC	Amber	¼" blade	¾"	5/8" Ø
PL-522-GC	PL-522-GC-BX	–	12V DC	Green	¼" blade	¾"	5/8" Ø



PL-523 Series • 12V LED Pilot Lights

- Approx. 3/4" bezel, fits 5/8" diameter hole (15.9mm). ¼" blade terminals.

PART NUMBERS			RATING	COLOR	TERMINALS	BEZEL SIZE	HOLE SIZE
BULK	BOXED	RETAIL					
PL-523-RC	PL-523-RC-BX	–	12V DC	Red	¼" blade	¾"	5/8" Ø
PL-523-AC	PL-523-AC-BX	–	12V DC	Amber	¼" blade	¾"	5/8" Ø
PL-523-GC	PL-523-GC-BX	–	12V DC	Green	¼" blade	¾"	5/8" Ø
PL-523-BC	PL-523-BC-BX	–	12V DC	Blue	¼" blade	¾"	5/8" Ø
PL-523-CC	PL-523-CC-BX	–	12V DC	Clear	¼" blade	¾"	5/8" Ø



PL-524 Series • 12V LED Pilot Lights

- Approx. 5/8" bezel, fits 1/2" diameter hole (15.9mm), 0.5 to 5.5mm thick. ¼" blade terminals.

PART NUMBERS			RATING	COLOR	TERMINALS	BEZEL SIZE	HOLE SIZE
BULK	BOXED	RETAIL					
PL-524-RC	PL-524-RC-BX	–	12V DC	Red	¼" blade	5/8"	½" Ø
PL-524-AC	PL-524-AC-BX	–	12V DC	Amber	¼" blade	5/8"	½" Ø
PL-524-GC	PL-524-GC-BX	–	12V DC	Green	¼" blade	5/8"	½" Ø



PL-525 & PL-526 Series • 12V LED Pilot Lights

- Approx. 3/8" bezel, snaps into 21/64" diameter hole (8.3mm), 0.5 to 2.0mm thick. 6-3/4" wire leads.
- PL-525 series is maintained illuminations; PL-526 series in blinking illumination.

PART NUMBERS			RATING	COLOR	TERMINALS	BEZEL SIZE	HOLE SIZE	BLINKING ILLUMINATION
BULK	BOXED	RETAIL						
PL-525-RC	–	–	12V DC	Red	6 ¾" wire leads	3/8"	21/64" Ø	
PL-525-AC	–	–	12V DC	Amber	6 ¾" wire leads	3/8"	21/64" Ø	
PL-525-GC	–	–	12V DC	Green	6 ¾" wire leads	3/8"	21/64" Ø	
PL-526-RC	–	–	12V DC	Red	6 ¾" wire leads	3/8"	21/64" Ø	•
PL-526-AC	–	–	12V DC	Amber	6 ¾" wire leads	3/8"	21/64" Ø	•
PL-526-GC	–	–	12V DC	Green	6 ¾" wire leads	3/8"	21/64" Ø	•



PL-612 & PL-624 Series • 12V & 24V LED Pilot Lights

- 0.63" bezel diameter, fits panels 5.1 to 7.6mm thick. 1.25" (31.7mm) body length. ¼" blade terminals.

PART NUMBERS			RATING	COLOR	TERMINALS	BEZEL SIZE	BODY LENGTH
BULK	BOXED	RETAIL					
PL-612-R	PL-612-R-BX	PL-612-R-BP	12V DC	Red	¼" blade	0.63"	1.25"
PL-612-A	PL-612-A-BX	PL-612-A-BP	12V DC	Amber	¼" blade	0.63"	1.25"
PL-612-G	PL-612-G-BX	PL-612-G-BP	12V DC	Green	¼" blade	0.63"	1.25"
PL-612-B	PL-612-B-BX	PL-612-B-BP	12V DC	Blue	¼" blade	0.63"	1.25"
PL-624-R	PL-624-R-BX	–	24V DC	Red	¼" blade	0.63"	1.25"
PL-624-A	PL-624-A-BX	–	24V DC	Amber	¼" blade	0.63"	1.25"
PL-624-G	PL-624-G-BX	–	24V DC	Green	¼" blade	0.63"	1.25"
PL-624-B	PL-624-B-BX	–	24V DC	Blue	¼" blade	0.63"	1.25"

Incandescent Pilot Lights

12V Incandescent Pilot Lights

Corrosion-resistant construction. Spring-actuated brass contacts assure proper contact with the bulb. 16AWG (1.0mm²) insulated stranded copper leads, 8" (203mm) long. Additional information: littelfuse.com/PilotLights

PL-2 Series • 12V Single Contact, Insulated Pilot Lights

- #53 bulb supplied, Plated brass bezel, satin finish.
- 5/16" (7.9mm) diameter mounting stem, 3/8" (9.5mm) long.



PART NUMBERS			RATING	LENS COLOR	TERMINALS	BEZEL SIZE	LENS SIZE
BULK	BOXED	RETAIL					
PL-2-RC000	PL-2-RC000-BX	–	12V DC	Red	2x 8" wire leads	½" (12.7mm) Ø	3/16" (4.76mm) Ø
PL-2-GC000	PL-2-GC000-BX	–	12V DC	Green	2x 8" wire leads	½" (12.7mm) Ø	3/16" (4.76mm) Ø
PL-2-BC000	PL-2-BC000-BX	–	12V DC	Blue	2x 8" wire leads	½" (12.7mm) Ø	3/16" (4.76mm) Ø

PL-118 Series • 12V Single Contact, Insulated Pilot Lights

- Mounts through rear of the panel. #1893 bulb supplied. Satin finish or black aluminum bezel.
- 11/16" (7.5mm) diameter mounting stem, 1/4" (6.4mm) long.



PART NUMBERS			RATING	LENS COLOR	BEZEL COLOR	TERMINALS	BEZEL SIZE	LENS SIZE
BULK	BOXED	RETAIL						
PL-118-RC000	PL-118-RC000-BX	–	12V DC	Red	Satin Silver	2x 8" wire leads	15/16" (23.8mm) Ø	5/8" (15.9mm) Ø
PL-118-GC000	PL-118-GC000-BX	–	12V DC	Green	Satin Silver	2x 8" wire leads	15/16" (23.8mm) Ø	5/8" (15.9mm) Ø
PL-118-AC000	PL-118-AC000-BX	–	12V DC	Amber	Satin Silver	2x 8" wire leads	15/16" (23.8mm) Ø	5/8" (15.9mm) Ø
PL-118-RC001	PL-118-RC001-BX	–	12V DC	Red	Black	2x 8" wire leads	15/16" (23.8mm) Ø	5/8" (15.9mm) Ø
PL-118-GC001	PL-118-GC001-BX	–	12V DC	Green	Black	2x 8" wire leads	15/16" (23.8mm) Ø	5/8" (15.9mm) Ø
PL-118-AC001*	–	–	12V DC	Amber	Black	2x 8" wire leads	15/16" (23.8mm) Ø	5/8" (15.9mm) Ø

PL-20 Series • 12V Single Contact, Insulated Pilot Lights

- #53 bulb supplied, Chrome-plated brass bezel, Contact us for custom imprinting.
- 3/4" (19.1mm) diameter mounting stem, 11/16" (17.5mm) long.



PART NUMBERS			RATING	LENS COLOR	TERMINALS	BEZEL SIZE	LENS SIZE
BULK	BOXED	RETAIL					
PL-20-RC000	PL-20-RC000-BX	–	12V DC	Red	2x 8" wire leads	7/8" (22.2mm) Ø	17/32" (13.5mm) Ø
PL-20-GC000	PL-20-GC000-BX	–	12V DC	Green	2x 8" wire leads	7/8" (22.2mm) Ø	17/32" (13.5mm) Ø
PL-20-AC000	PL-20-AC000-BX	–	12V DC	Amber	2x 8" wire leads	7/8" (22.2mm) Ø	17/32" (13.5mm) Ø
PL-20-BC000*	–	–	12V DC	Blue	2x 8" wire leads	7/8" (22.2mm) Ø	17/32" (13.5mm) Ø

PL-36 Series • 12V Single Contact, Insulated with Faceted Lens Pilot Lights

- Lenses have honeycomb pattern on the internal side, smooth on the outside.
- #53 bulb supplied, Satin finish stainless steel bezel.
- 1/2" (12.7mm) diameter mounting stem, 3/8" (9.5mm) long.



PART NUMBERS			RATING	COLOR	TERMINALS	BEZEL SIZE	LENS SIZE
BULK	BOXED	RETAIL					
PL-36-RC000	PL-36-RC000-BX	–	12V DC	Red	2x 8" wire leads	¾" (19.1mm) Ø	5/16" (8.0mm) Ø
PL-36-GC000	PL-36-GC000-BX	–	12V DC	Green	2x 8" wire leads	¾" (19.1mm) Ø	5/16" (8.0mm) Ø
PL-36-AC000	PL-36-AC000-BX	–	12V DC	Amber	2x 8" wire leads	¾" (19.1mm) Ø	5/16" (8.0mm) Ø
PL-36-BC000	PL-36-BC000-BX	–	12V DC	Blue	2x 8" wire leads	¾" (19.1mm) Ø	5/16" (8.0mm) Ø

PL-1 Series • 12V Single Contact, Grounding Pilot Lights

- Self-grounding to metal panels.
- #53 bulb supplied, Chrome-plated brass bezel, satin finish.
- 5/16" (7.9mm) diameter mounting stem, 3/8" (9.5mm) long.



PART NUMBERS			RATING	COLOR	TERMINALS	BEZEL SIZE	LENS SIZE
BULK	BOXED	RETAIL					
PL-1-RC000	PL-1-RC000-BX	–	12V DC	Red	1x 8" wire leads	½" (12.7mm) Ø	3/16" (4.8mm) Ø
PL-1-GC000*	–	–	12V DC	Green	1x 8" wire leads	½" (12.7mm) Ø	3/16" (4.8mm) Ø

*Special Order Item

PL-19 Series • 12V Single Contact

- #53 bulb supplied, Plated brass bezel.
- $\frac{3}{4}$ " (19.1mm) diameter mounting stem, $\frac{11}{16}$ " (17.5mm) long.



PART NUMBERS			RATING	LENS COLOR	TERMINALS	BEZEL SIZE	LENS SIZE
BULK	BOXED	RETAIL					
PL-19-RC000	PL-19-RC000-BX	–	12V DC	Red	1x 8" wire leads	7/8" (22.2mm) Ø	17/32" (14.5mm) Ø
PL-19-GC000	PL-19-GC000-BX	–	12V DC	Green	1x 8" wire leads	7/8" (22.2mm) Ø	17/32" (14.5mm) Ø
PL-19-AC000	PL-19-AC000-BX	–	12V DC	Amber	1x 8" wire leads	7/8" (22.2mm) Ø	17/32" (14.5mm) Ø
PL-19-BC000	–	–	12V DC	Blue	1x 8" wire leads	7/8" (22.2mm) Ø	17/32" (14.5mm) Ø

PL-85 Series • 12V Single Contact, with Faceted Lens

- #67 bulb supplied, Plated brass bezel.
- $\frac{7}{8}$ " (22.2mm) diameter mounting stem, $\frac{3}{4}$ " (19.1mm) long.
- Faceted outer lens surface.
- Gasket sealed.



PART NUMBERS			RATING	LENS COLOR	TERMINALS	BEZEL SIZE	LENS SIZE
BULK	BOXED	RETAIL					
PL-85-RC000	PL-85-RC000-BX	–	12V DC	Red	1x 8" wire leads	1¼" (31.8mm) Ø	15/16" (23.8mm) Ø
PL-85-GC000	PL-85-GC000-BX	–	12V DC	Green	1x 8" wire leads	1¼" (31.8mm) Ø	15/16" (23.8mm) Ø
PL-85-AC000	PL-85-AC000-BX	–	12V DC	Amber	1x 8" wire leads	1¼" (31.8mm) Ø	15/16" (23.8mm) Ø

PL-86 Series • 12V Double Contact, Insulated

- #68 bulb supplied, Plated brass bezel.
- $\frac{7}{8}$ " (22.2mm) diameter mounting stem, $\frac{3}{4}$ " (19.1mm) long.
- Gasket sealed.



PART NUMBERS			RATING	LENS COLOR	TERMINALS	BEZEL SIZE	LENS SIZE
BULK	BOXED	RETAIL					
PL-86-RC000	PL-86-RC000-BX	–	12V DC	Red	2x 8" wire leads	1¼" (31.8mm) Ø	15/16" (23.8mm) Ø
PL-86-GC000	PL-86-GC000-BX	–	12V DC	Green	2x 8" wire leads	1¼" (31.8mm) Ø	15/16" (23.8mm) Ø
PL-86-AC000	PL-86-AC000-BX	–	12V DC	Amber	2x 8" wire leads	1¼" (31.8mm) Ø	15/16" (23.8mm) Ø

Panel Lamps and Base Sockets



DL Series • 12V Single Contact, Grounding Pilot Lights

- Self-grounding to metal panels
- For illumination of maps or other items, with minimal interference of driving visibility
- Hood can be rotated to direct the light beam
- 11/16" (17.5mm) diameter mounting stem, 3/8" (9.5mm) long; mount through the panel.
- 16AWG insulated stranded copper leads
- Suggested lamps (not included): #63 (6V), #67 (12V), #623 (24V).



PART NUMBERS			RATING	COLOR	MATERIAL	TERMINALS
BULK	BOXED	RETAIL				
DL-13	DL-13-BX	–	12V DC	Chrome-plated	Brass	1x 8" wire leads
DL-21	DL-21-BX	–	12V DC	Black	Steel	1x 8" wire leads

12V Bayonet Base Sockets

- Accept incandescent or LED bulbs with corresponding bases.
- Suggested lamp numbers for BA15s sockets: 63, 67, 81, 87, 93, 97, 103, 209, 1073, 1129, 1133, 1141, 1156.
- 16AWG insulated stranded copper leads 8" (203mm) long



26145



2609



3575



2611

PART NUMBERS			RATING	LAMPS ACCEPTED	MOUNTING	TERMINALS	CONTACT TYPE	NOTES
BULK	BOXED	RETAIL						
26145	–	–	12V DC	BA15s	–	2x 8" wire lead (Ground Wire)	Single	For back-up, tail, stop, turn signal & corner lights. Replaces: GMC 8909518, International 57121C91, Motorcraft LS-22.
2609	2609-BX	–	12V DC	BA15s	Side bracket with 3/16" (4.8mm) Ø hole	1x 8" wire lead	Single	–
3575	3575-BX	–	12V DC	BA15s	Bottom bracket with two 13/64" (5.2mm) Ø holes, 1/2" (12.7mm) on centers	1x 8" wire lead	Single	–
2611*	–	–	12V DC	BA15s	3/4" (19.0mm) Ø hole	1x 8" wire lead	Single	–
2612*	–	–	12V DC	BA15d	3/4" (19.0mm) Ø hole	2x 8" wire leads	Double	–



2505



2506

Miniature Base Sockets - Single Contact

- Suggested lamp numbers: 51 (6V), 53 (12V), 356 (24V).
- Plated steel sockets

PART NUMBERS			RATING	LAMPS ACCEPTED	MOUNTING	TERMINALS	CONTACT TYPE	NOTES
BULK	BOXED	RETAIL						
2505	2505-BX	–	12V DC	BA9	5/8" (15.9mm) Ø hole	1x 8" wire leads	Single	Socket spacer rings to fit other panel thicknesses available
2506	2506-BX	–	12V DC	BA9	5/8" (15.9mm) Ø hole	2x 8" wire leads	Single	Ground lead attached to shell



2560



2564

Pigtail Assemblies

- For different lead lengths, colors and materials, please contact Littelfuse
- Leads are made from high quality 16AWG (1.0mm²) thermoplastic jacketed wire.
- Phenolic washers insulate the assemblies.

PART NUMBERS			CONTACT TYPE	FITS SOCKET PART NUMBERS	NOTES
BULK	BOXED	RETAIL			
2560	2560-BX	–	Single	2601, 2609, 2611, 2645, 2670, 3575, 26003, 26041.	–
2564	2564-BX	–	Double	2602, 2608, 2610, 2612, 26041.	Ears in line with contacts

*Special Order Item



4099 • 12 & 24V DC Universal Buzzer

Hundreds of uses. For 'door ajar' warning, bus driver alert, low air pressure, temperature, etc. Works with any temperature, pressure, door or momentary switch. Electrical contacts are designed for instant response and uninterrupted signal.

Additional information: littelfuse.com/Alarms

PART NUMBERS			VOLTAGE	DIMENSIONS	TERMINALS	NOTES
BULK	BOXED	RETAIL				
4099	4099-BX	4099-BP	12V DC	–	2 Screw	–
40151	40151-BX	–	24V DC	–	2 Screw	–

40100 • Buzzer Pull Switch



For use by passengers in buses and rapid transit vehicles, the end of the switch attaches to a cord. Use with Littelfuse buzzers or buzzer/flashers: 4099, 4112 RC, 4124-RD.

SPST Off-Mom. On. Normally Off, pull to On, spring return to Off. Neutral gray enamel finish cover. Operates with a pull cord.

Additional information: littelfuse.com/Alarms

PART NUMBERS			VOLTAGE	DIMENSIONS	TERMINALS	NOTES
BULK	BOXED	RETAIL				
40100	40100-BX	–	Up to 36V DC	–	2 Screw	Replaces: Delco 1998723, 18998802, 1998020



4112-RC • 12 & 24V DC Buzzer and LED Indicator "Dual Alarm"

Rugged combination warning light and buzzer gives audible and visible alert. Device is a universal application and can be used with any electrical switch. Red lens, long-life LED. 11/16" (17.46mm) diameter mounting stem, 17/32" (13.88mm) long.

Additional information: littelfuse.com/Alarms

PART NUMBERS			VOLTAGE	DIMENSIONS	TERMINALS	NOTES
BULK	BOXED	RETAIL				
4112-RC000	4112-RC000-BX	–	12V DC	1 7/8" x 1" x 1 11/32" (47.6 x 25.4 x 34.1mm)	2 Screw	–
4124-RD000	4124-RD000-BX	–	24V DC	1 7/8" x 1" x 1 11/32" (47.6 x 25.4 x 34.1mm)	2 Screw	–

40212 • 12V DC Dual Rate Electronic Alarm

Utilizes advanced integrated circuit surface mount technology. Negative ground. Use with two input sources to warn of two different hazardous conditions. Sounds at two different rates: one sensor triggers a fast-rate alarm, the second actuates a slower rate alarm tone.

- Minimum sound level: 90dB
- Lightweight molded plastic housing
- Solid-state circuitry
- Plugs into Littelfuse connector 3032 or 3029, Delphi (Packard) 12033871, or accepts connectors for 1/4" (6.4mm) blades

Additional information: littelfuse.com/Alarms

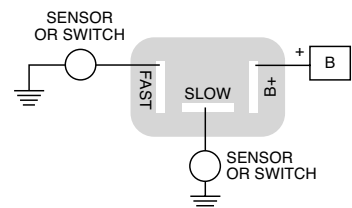

PART NUMBERS			VOLTAGE	DIMENSIONS	TERMINALS	NOTES
BULK	BOXED	RETAIL				
40212	40212-BX	–	12V DC	2.005" x 1.185 x .930" (50.4 x 30.3 x 23.66mm)	¼" Blades	Minimum sound level: 90dB

Alphanumeric Part Number Index

Part Number	Page	Part Number	Page	Part Number	Page	Part Number	Page	Part Number	Page	Part Number	Page
00940133ZP	25	00970023XP	42	0940552Z	21	OMRS0005Z	24	12400	105	24624-10	51
00940134ZP	25	00970025XPA	42	OACBxxx.xx	16	OMRS0006Z	24	12401	105	24712-GS7	51
00940135ZP	25	00970026XP	42	OAFH0001XP	36	OMRS0007Z	24	12500	105	24712-S7	51
00940154ZP	25	00970035XP	42	OAFH0002XP	36	OMRS0009ZXA	24	12501	105	24812	51
00940189ZP	25	00970038XP	42	OAGA0001ZP	25	OMRS0200Z	24	1253	103	24812-01	51
00940202ZP	25	00970053XP	42	OAGAxxx.x	14	OMRS0200ZXE	24	1254	103	24824-01	51
00940202ZPGLO	25	00970054XPA	42	OAGC0001ZP	25	OMRS0200ZXMA	24	1255	102	2484	57
00940301ZP	25	01520003TXN	35	OAGC0001ZPGLO	25	OMRS0300Z	24	1257	103	2484-02	57
00940362ZP	25	01520003TXN941	35	OAGCxxx.x	14	OMRS0300ZXE	24	1258	103	2484-03	57
00940362ZPGLO	25	01520003TXN942	35	OAGUxxx.x	14	OMXBxxx.x	17	1282	104	2484-06	57
00940363ZP	26	0185xxx.x	18	OAGW0001ZP	25	OPALxxx.x	13	1283-325	104	2484-09	57
00940365ZP	26	0211xxx.x	18	OAGWxxx.x	14	ORBOX001Z	23	24021	50	2484-16	57
00940366ZP	26	02980900S	34	OAGXxxx.x	14	ORBOX002Z	23	24022	50	2484-19	57
00940367ZP	26	02980900TXN	34	OATD0200XBP	42	ORBOX003Z	23	24023	50	2484-A	57
00940368ZP	26	02980900Z	34	OATD0300ZBP	42	ORBOX004Z	23	24037	50	24848	57
00940369ZP	26	02981028HXFC	34	OATOxxx.x	9	ORBOX005Z	23	24044	50	2505	111
00940370ZP	26	02981028HXFC-SS	34	OBPF0001ZP	41	ORBOX006Z	23	24046	50	2506	111
00940396Z	22	03270xx.xxx	10	OCBFxxx.x	17	OREDOBOXZ	23	24047	50	2560	111
00940400Z	25	03370xx.xxx	10	OCCBxxx.x	16	OREDOBOXZXNG	23	24054	92	2564	111
00940400ZGLO	25	03453LF2XP	38	OFBCxxx.x	16	OREDOBOXZXNGA	23	24059	49	2609	111
00940402ZP	27	03453LF8XP	38	OFHA0001XP	36	OSFE0001ZP	25	24059-08	49	2611	111
00940408ZP	25	03500417XP	39	OFHA0001XPGLO	36	OSFE0001ZPGLO	25	24060	50	2612	111
00940409Z	21	03500418XP	39	OFHA0002XP	36	OSFExxx.x	14	24063	49	26145	111
00940412ZP	25	03540801ZXGY	39	OFHA0030XP	36	OUCBxxx.x	17	24063-08	49	30055-10	19
00940413ZP	27	03540802ZXGY	39	OFHA0200Z	41	11041	104	24071	50	30055-15	19
00940416Z	25	03540803ZXGY	39	OFHA0200ZP	41	11041-06	104	24076	50	30055-20	19
00940418ZP	26	03540804ZXGY	39	OFHJ1001G	37	11042	104	24080	49	30055-25	19
00940419ZP	26	03540805ZXGY	39	OFHJ1002G	37	11042-05	104	24080-01	49	30055-30	19
00940422Z	21	03540806ZXGY	39	OFHJ2001G	37	11134	105	24082	49	30055-40	19
00940461ZP	26	03560001Z	40	OFHJ2002G	37	11164	106	24097	49	30055-50	19
00940462Z	25	03560002Z	40	OFHM0001XP	36	11165	106	24103	50	30055-8	19
00940462ZGLO	25	03560003Z	40	OFHM0001XPGLO	36	11172	105	24106	49	30056-10	19
00940475Z	25	03560004Z	40	OFHM0002XP	36	11173	105	24107	49	30056-15	19
00940479ZP	26	03560005Z	40	OFHM0200Z	41	11178	106	24115	49	30056-30	19
00940480Z	21	03560006Z	40	OFHM0200ZP	41	1160	106	24117	49	30056-40	19
00940500Z	25	03560007Z	40	OFHP0001Z	38	11750	106	24117-01	49	30056-50	19
00940506ZP	25	03560008Z	40	OFLC014.XP	27	12063	101	24124	49	30056-8	19
00940509ZXGLOA	22	03560009Z	40	OFLW014.XP	27	12063-01	101	24135	49	30062-20	19
00940510ZXGLOA	22	03560010Z	40	OFLW016.XP	27	12077-01	101	24200	52	30062-30	19
00940550Z	25	03560011Z	40	OFNY0001XP	38	12080	101	24213	49	30063-10	19
00940553Z	21	03560012Z	40	OFNY0020XP	38	12080-01	101	24214	49	30063-20	19
00940554Z	25	04980921.X	35	OFNY0030XP	38	12080-11	101	24401	51	30063-30	19
00940555ZPGLO	25	049809216XM5	35	OGBCxxx.x	14	12081	102	24401-01	51	30090-2	20
00940556ZPDSGLO	25	04980932.X	31	OMAB0001XP	35	12082	102	24401-04	49	30090-3	20
00940556ZPGLO	25	04980933.X	31	OMAXxxx.x	9	12091	102	24401-04	51	30090-4	20
00940557ZXA	25	04981038HXFC	34	OMCBxxx.x	17	12092	102	24402	51	30090-6	20
00940558ZPA	25	04982001ZXFC	34	OMEGxxx.x	12	1214	104	24420	49	30090-8	20
00940559ZPA	25	0695xxx.x	11	OMIBxxx.x	16	1222	102	24450	52	30128-10	19
00940560ZXA	21	07981002ZXS	31	OMIDxxx.x	12	12300	100	24450-02	52	30128-15	19
00940561ZPA	26	0812xxx.xxxx	20	OMINxxx.x	8	12301	100	24452	54	30128-20	19
00940562ZPA	26	0813xxx.xxxx	20	OMMBxxx.x	16	12310	101	24505	60	30128-30	19
00940563ZPA	26	09230025LXBLK	60	OMRS0001Z	24	12311	102	24512-03	51	30128-40	19
00940565ZXA	21	09230025LXBLKM8	60	OMRS0002Z	24	1232	103	24512-10	51	30137-10	19
00940566ZXA	25	09230025LXRED	60	OMRS0003Z	24	1233	103	24612-03	51	30137-15	19
00940570ZXA	21	09230025LXREDM8	60	OMRS0003ZXE	24	1235	103	24612-10	51	30137-20	19
00970019XP	42	0940551Z	21	OMRS0004Z	24	1236	103	24612-G13	51	30137-30	19

Alphanumeric Part Number Index

Part Number	Page	Part Number	Page	Part Number	Page	Part Number	Page	Part Number	Page	Part Number	Page
30137-6	19	46377-8	39	54104	76	5520	77	58311-11	68	59024-110	79
30138-10	19	46379-6	39	54105	76	5543	80	58311-13	68	59024-116	79
30138-15	19	46379-8	39	54107	76	5543-15	80	58311-16	68	59024-118	79
30138-25	19	48051	44	54109	76	5558	77	58311-18	68	59024-12	79
30138-30	19	48070	44	54110	76	5565	77	58312-A2	68	59024-13	79
30138-40	19	48090	44	54204-01	74	5582	77	58312-A4	68	59024-14	79
30171-10	19	48092	44	54403-01	74	5582-10	77	58312-AG	68	59024-15	79
30171-15	19	48120	44	55014	77	5584	77	58312-AR	68	59024-16	79
30171-20	19	48122	44	55014-05	77	5586	77	58312-C4	68	59024-200	79
30171-30	19	48160	44	55015	77	5590	77	58312-G2	68	59024-201	79
30172-10	19	48161	44	55015-03	80	5592	77	58312-G4	68	59024-202	79
30172-15	19	48162	44	55016	77	56000-01	73	58312-GA4	68	59024-204	79
30172-20	19	48510	46	55017	77	56000-02	73	58312-R2	68	59024-206	79
30172-30	19	48512	46	55018	77	56000-04	73	58312-R4	68	59024-208	79
3031-0	38	48513	46	55019	77	56000-08	73	58312-RG2	68	59024-210	79
3031-20	38	48513-01	46	55020-04	77	56001-04	73	58312-RG3	68	59024-216	79
3031-30	38	48513-02	46	55021	77	56027-01	70	58312-RG4	68	59024-218	79
30401-15	19	48513-03	46	55021-07	77	563	59	58312-RR	68	59024-33	79
30401-20	19	48514	46	55023	77	56300-01	73	58312-RR2	68	59024-34	79
30407-15	19	48514-01	46	55025	76	56300-11	73	58312-RR4	68	59024-35	79
30407-20	19	48514-02	46	55025-01	76	56327-01	70	58324-R1	68	59024-36	79
30407-25	19	48521	48	55025-02	76	56328-101	69	58326-01	71	59024-37	79
30407-30	19	48525	44	55025-03	76	57000-01	73	58326-06	71	59024-38	79
30407-40	19	48530	44	55025-04	76	57000-02	73	58326-11	71	59071	80
30414-30	19	48535	45	55026	76	57000-04	73	58327-01	70	68362	92
30414-50	19	48535-01	45	55033-01	77	57000-10	73	58327-06	70	68363	92
30507-60	19	48540	45	55036	77	57000-23	73	58328-01	69	71092	91
30507-80	19	48540-01	45	55046	77	57000-23	73	58328-02	69	71092-02	91
3088-50	19	48541	45	55054	77	57001-01	73	58328-04	69	7112	91
3088-60	19	48541-01	45	55054-04	77	57003-01	73	58328-06	69	7124	91
3088-80	19	48610	45	55055	77	57005-11	73	58328-08	69	7127	91
311xxx.x	15	48610-01	45	55064	80	57006-01	73	58328-10	69	7152	91
312xxx.x	15	48636	45	55065-02	77	57007-01	73	58328-100	69	7157	91
313xxx.xxx	15	48636-01	45	55065-03	77	57007-08	73	58328-102	69	72079-01	94
314xxx.x	15	48715	48	5507	77	57007-11	73	58328-103	69	72100	91
3298xxx.x	12	48716	48	55071	80	57013-08	73	58328-104	69	74600-02	94
3575	111	48736	45	55088	77	57300-01	73	58328-11	69	74601-01	94
362xxx.x	15	48785	48	551001	78	57300-02	73	58328-12	69	74603	94
3AG	15	50001	90	551800	78	57300-03	73	58328-13	69	7493	91
40100	112	50002	90	551801	78	58027-01	70	58328-16	69	7493-07	91
40151	112	50036	90	551802	78	58027-02	70	58328-22	69	7496	91
40212	112	50046	90	551805	78	58027-03	70	58328-25	69	7496-04	91
407-01	85	50066	90	551806	78	58027-04	70	58328-26	69	75125	97
407-02	85	5007	90	551840	78	58027-06	70	58328-33	69	75212-04	96
407-03	85	50070	90	551841	78	58027-07	70	58328-34	69	75217-04	96
4099	112	50082	90	551842	78	58027-08	70	58328-35	69	75221-06	96
4112-RC000	112	5011	90	551843	78	58027-11	70	58328-36	69	75221-09	96
4124-RD000	112	50203	90	551844	78	58027-18	70	58328-40	69	75226	96
46210-02	60	5050	90	551845	78	58028	90	58506-07	74	75228-03	96
46210-03	60	5066	90	551846	78	58311-01	68	58506-08	74	75228-04	96
46211-01	60	54007	72	551849	78	58311-02	68	59024-100	79	75236	96
46211-R	60	54010	72	551850	78	58311-03	68	59024-101	79	75600	95
46377-10	39	54012	72	551851	78	58311-04	68	59024-102	79	75600-01	95
46377-12	39	54100	76	551855	78	58311-06	68	59024-104	79	75600-02	95
46377-18	39	54101-01	76	551861	78	58311-07	68	59024-106	79	75600-04	95
46377-6	39	54103	76	551862	78	58311-08	68	59024-108	79	75600-05	95

Alphanumeric Part Number Index

Part Number	Page	Part Number	Page	Part Number	Page	Part Number	Page	Part Number	Page	Part Number	Page
75600-07	95	8367	66	9075	86	95061-36	62	95634-01	64	LMINxxx.x	8
75602-02	95	8487	98	9087	88	95061-50	62	9577	64	LPJCASE	11
75602-04	95	86099-2	20	9095	84	95061-60	62	9578	64	LPMINI	8
75705-01	65	86099-3	20	9109	84	95062-10	62	9579	64	LTX	31
75705-01	92	86099-4	20	91113	97	95062-13	62	9579-02	64	LX	32
75712-04	92	86099-5	20	9115	84	95062-17	62	96101	86	M-115	105
75903	58	86126-12	20	9118	87	95062-50	62	96102	86	M-121	105
75904	58	86126-2	20	9155	84	95062-53	62	9622-01	64	M-284	57
75904-01	58	86126-4	20	9162-03	97	95062-57	62	98628	72	M-284-01	57
75904-03	58	86126-6	20	9165	84	9513	64	98635-01	66	M-284-02	57
75907	58	86126-8	20	91800	87	9518	64	98647	106	M-284-09	57
75908	57	8626	98	91801	87	95410	65	99025	54	M-284-A	57
75912	58	8629	98	91811	87	95517-A	64	99026	54	M-288	64
75920	56	8645	98	91812	87	95521-01	64	AGA	14	M-290	58
75920-05	56	87128-10	20	91823	88	95521-B	64	AGC	14	M-290-01	58
75920-10	56	87128-13	20	9183	93	95522-A	64	AGU	14	M-290-05	58
75921	56	87128-4	20	92102	97	95524-A	64	AGW	14	M-414-01	40
75921-10	56	87128-6	20	92107-04	97	95525-A	64	AGX	14	M-415-01	40
7700	93	8715	98	9211	84	95526-A	64	ATO	9	M-54111-01	78
7702	93	87167-01	72	9212	84	95532	64	BPDMA104HXF1	31	M-54111-02	78
7762	93	880014	34	9224	97	95534	64	CNL	27	M-58031-01	71
7785	93	880051	45	9231	84	95539	64	CNN	27	M-58031-02	71
7786	93	880055	45	9238	84	95561-01	64	DL-13	111	M-58031-04	71
7787	93	880062	56	9242	97	95564-01	64	DL-21	111	M-58031-06	71
7792	93	880064	56	9242-01	97	95582	64	FHAC0001XP	36	M-58031-07	71
79004-02	58	880073	32	9245	84	95591	64	FHAC0002XP	36	M-58031-08	71
80101-B	60	880086	52	9251	88	95597	64	FHJC1002L	37	M-58031-09	71
81192	106	880088	52	9264	87	956-3122	63	FHJC2002L	37	M-606	90
81255	80	880089	32	9264-02	87	956-3124	63	FHLM0200Z	41	M-608	85
81264	80	880094	32	9270	88	956-3125	63	FHLM0200ZPA	41	M-641-01	40
81264-01	80	880103	52	9270-01	88	956-3126	63	FHM20200Z	41	M-643-01	40
81264-05	80	880107	52	9500	65	956-3127	63	FHM20200ZPA	41	M-674	40
81298-02	96	880154	56	9500	92	956-4100	63	FLEC	32	M-676	66
81298-34	96	880175	56	95033	64	956-4104	63	FLEC3000Z-0	32	M-750	59
81356	100	880195400	32	95060	62	956-4107	63	Flex-MEGA	34	M-752	59
82065	60	880209	46	95060-01	62	956-4111	63	Flex-MIDI	34	M-753	59
82065-02	60	880210	46	95060-02	62	956-4113	63	GBC	14	M-754	59
82065-03	60	880211	46	95060-03	62	956-4116	63	HPDM	32	M-850	66
82159-02	72	90005-03	92	95060-04	62	956-4124	63	HWA20	31	MA-150024-NN	53
82159-03	72	9001	88	95060-05	62	956-4138	63	HWB12	30	MAHC0001ZXJ	35
82159-1	72	9003	87	95060-06	62	956-4141	63	HWB18	30	MAHC0001ZXJA	35
82159-2	72	90030	84	95060-07	62	956-4154	63	HWB6	30	MAXI	9
82159-3	72	90030-01	84	95060-21	62	956-4307	63	HWB60	30	MC-150024-RN	53
82468	80	90030-04	84	95060-23	62	956-4311	63	HWB60-AL	30	MC-250012-DN	53
83280	85	90036-02	84	95060-26	62	956-5109	63	JBPT0001Z	60	MC-250012-NN	53
83280-02	85	90043	85	95060-29	62	956-5122	63	JBPT2N02ZXB	60	MC-250012-RN	53
83280-03	85	90043-07	85	95060-34	62	956-5124	63	JBPT2N03ZXB	60	MC-250012-RS	53
83280-05	85	90047	86	95060-36	62	956-5307	63	JBPT2P01ZXR	60	MCASE	11
83285-01	66	90047-01	86	95060-43	62	956-6107	63	JBPT3N03ZXB	60	MDB	31
83288	66	90048	86	95060-50	62	956-6307	63	JBPT3N03ZXR	60	MEGA	12
83353	60	90048-01	86	95060-51	62	956-6310	63	JBPT3P01ZXB	60	MICRO2	10
83353	66	9023	84	95060-60	62	956-9100	63	JBPT3P02ZXB	60	MICRO3	10
83357	66	9044	84	95061	62	95610	64	JBPT4P01ZXB	60	MIDI	12
83373	66	9052	97	95061-01	62	95612	64	JCASE	11	MINI	8
83377	98	9055	87	95061-04	62	95613	64	JCASxxx.x	11	MTR	31
83379	66	9060	93	95061-07	62	95633-A	64	LJCAxxx.x	11	PAL	13

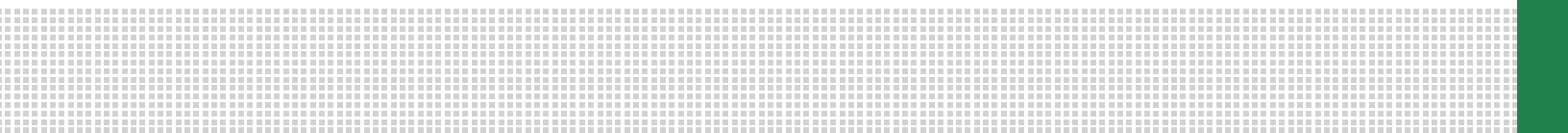

Littelfuse Aftermarket Products
Chicago, Illinois USA
+1 617.268.2100
CVP_info@littelfuse.com

To learn more about specific
products or applications visit:
Littelfuse.com/Aftermarket