

GX SERIES

- FIBER SENSORS
- LASER SENSORS
- PHOTOELECTRIC SENSORS
- MICRO PHOTOELECTRIC SENSORS
- AREA SENSORS
- LIGHT CURTAINS / SAFETY COMPONENTS
- PRESSURE / FLOW SENSORS
- INDUCTIVE PROXIMITY SENSORS**
- PARTICULAR USE SENSORS
- SENSOR OPTIONS
- SIMPLE WIRE-SAVING UNITS
- WIRE-SAVING SYSTEMS
- MEASUREMENT SENSORS
- STATIC ELECTRICITY PREVENTION DEVICES
- LASER MARKERS
- PLC
- HUMAN MACHINE INTERFACES
- ENERGY CONSUMPTION VISUALIZATION COMPONENTS
- FA COMPONENTS
- MACHINE VISION SYSTEMS
- UV CURING SYSTEMS

Related Information

- General terms and conditions..... F-7
- Glossary of terms..... P.1482~
- Sensor selection guide P.803~
- General precautions P.1485~



panasonic.net/id/pidsx/global

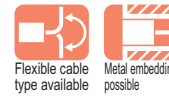

Robust enclosure and flexible cable types are also available

VARIETIES

Miniature

GX-3S

The **GX-3S** is an amplifier built-in inductive proximity sensor having a diameter of just $\varnothing 3.8$ mm $\varnothing 0.150$ in.



Robust housing

GX-4S

The **GX-4S** uses a robust stainless steel enclosure. The tightening torque can be 0.58 N·m or less. (2 times compared with conventional models)

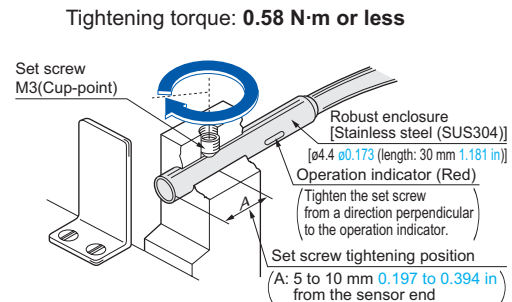

BASIC PERFORMANCE

Long sensing range

GX-8ML

The non-shielded type (**GX-8ML**) has twice the sensing range of the shielded type (**GX-8M**), although having the same size. Hence, it allows margin against sensing distance variations.

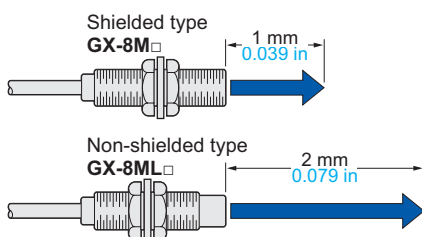

ENVIRONMENTAL RESISTANCE

Ten times greater bending durability (Compared with conventional models)

GX-□-R

The bending durability of the cable to repeated bending has been increased tenfold by using special alloy cores for the cable.

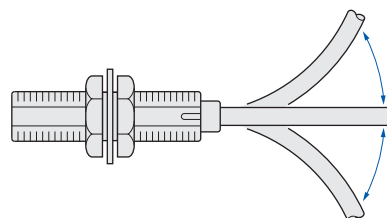

- Selection Guide
- Amplifier Built-in
- Amplifier-separated
- GX-F/H
- GXL
- GL
- GX-M
- GX-U/GX-FU/GX-N
- GX**

APPLICATIONS

Sensing screws on cassette

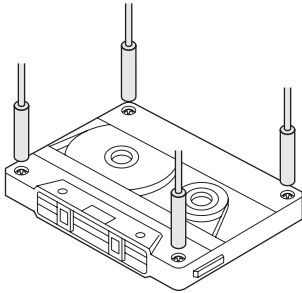

Sensing the punch of a die

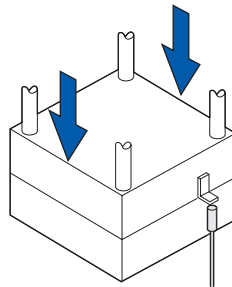

Counting parts

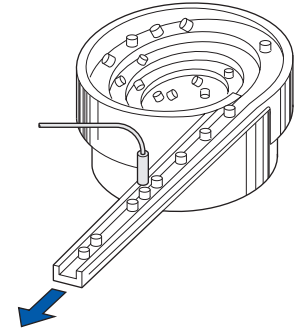

ORDER GUIDE

Type	Appearance (mm in)	Sensing range (Note)	Model No.	Supply voltage	Output	Output operation
Shielded type		Maximum operation distance 0.8 mm 0.031 in (0 to 0.6 mm 0 to 0.024 in) Stable sensing range	GX-3S	12 to 24 V DC ±10 %	NPN open-collector transistor	Normally open
			GX-3SB			Normally closed
	Robust enclosure type	0.8 mm 0.031 in (0 to 0.6 mm 0 to 0.024 in)	GX-4S			Normally open
			GX-4SB			Normally closed
		1 mm 0.039 in (0 to 0.8 mm 0 to 0.031 in)	GX-5S	10 to 30 V DC		Normally open
			GX-5SB	10 to 30 V DC		Normally closed
Threaded type		0.8 mm 0.031 in (0 to 0.6 mm 0 to 0.024 in)	GX-5M	12 to 24 V DC ±10 %	Normally open	
			GX-5MB		Normally closed	
		1 mm 0.039 in (0 to 0.8 mm 0 to 0.031 in)	GX-8M	10 to 30 V DC	Normally open	
			GX-8MB		Normally closed	
Non-shielded type		2 mm 0.079 in (0 to 1.6 mm 0 to 0.063 in)	GX-8ML		Normally open	
			GX-8MLB		Normally closed	

Note: The maximum operation distance stands for the maximum distance for which the sensor can detect the standard sensing object.
 The stable sensing range stands for the sensing range for which the sensor can stably detect the standard sensing object even if there is an ambient temperature drift and/or supply voltage fluctuation.

- FIBER SENSORS
- LASER SENSORS
- PHOTO-ELECTRIC SENSORS
- MICRO PHOTO-ELECTRIC SENSORS
- AREA SENSORS
- LIGHT CURTAINS / SAFETY COMPONENTS
- PRESSURE / FLOW SENSORS
- INDUCTIVE PROXIMITY SENSORS
- PARTICULAR USE SENSORS
- SENSOR OPTIONS
- SIMPLE WIRE-SAVING UNITS
- WIRE-SAVING SYSTEMS
- MEASUREMENT SENSORS
- STATIC ELECTRICITY PREVENTION DEVICES
- LASER MARKERS
- PLC
- HUMAN MACHINE INTERFACES
- ENERGY CONSUMPTION VISUALIZATION COMPONENTS
- FA COMPONENTS
- MACHINE VISION SYSTEMS
- UV CURING SYSTEMS
- Selection Guide
- Amplifier Built-in
- Amplifier-separated
- GX-F/H**
- GXL**
- GL**
- GX-M**
- GX-U/GX-FU/GX-N
- GX**

FIBER SENSORS

LASER SENSORS

PHOTO-ELECTRIC SENSORS

MICRO PHOTO-ELECTRIC SENSORS

AREA SENSORS

LIGHT CURTAINS/SAFETY COMPONENTS

PRESSURE / FLOW SENSORS

INDUCTIVE PROXIMITY SENSORS

PARTICULAR USE SENSORS

SENSOR OPTIONS

SIMPLE WIRE-SAVING UNITS

WIRE-SAVING SYSTEMS

MEASURE-MENT SENSORS

STATIC ELECTRICITY PREVENTION DEVICES

LASER MARKERS

PLC

HUMAN MACHINE INTERFACES

ENERGY CONSUMPTION VISUALIZATION COMPONENTS

FA COMPONENTS

MACHINE VISION SYSTEMS

UV CURING SYSTEMS

Selection Guide

Amplifier Built-in

Amplifier-separated

GX-F/H

GXL

GL

GX-M

GX-U/GX-FU/GX-N

GX

ORDER GUIDE

Flexible cable type

Flexible cable type is also available for shielded type. When ordering this type, suffix "-R" to the model No. (e.g.) Flexible cable type of **GX-3S** is "**GX-3S-R**".

5 m 16.404 ft cable length type

5 m **16.404 ft** cable length type (standard: 3 m **9.843 ft**) is also available. (excluding **GX-4SB**) When ordering this type, suffix "-C5" to the model No. (e.g.) 5 m **16.404 ft** cable length type of **GX-3S** is "**GX-3S-C5**".

Refer to table below for 5 m **16.404 ft** cable length type of flexible cable type sensor.

• Table of model Nos.

Type		Standard	Flexible cable of 5 m 16.404 ft cable length type
Shielded type	Non-threaded type	GX-3S	GX-3S-R-C5
		GX-3SB	GX-3SB-R-C5
		GX-4S	GX-4S-R-C5
		GX-4SB	—————
		GX-5S	GX-5S-R-C5
	Threaded type	GX-5SB	—————
		GX-5M	GX-5M-R-C5
		GX-5MB	—————
		GX-8M	GX-8M-R-C5
		GX-8MB	GX-8MB-R-C5

Accessories

- **MS-SS3** (Sensor mounting bracket for **GX-3S** type)
- **MS-SS3-2** (C bracket for **GX-3S** type)
- **MS-SS5** (Sensor mounting bracket for **GX-5S** type)

- **MS-SS3**
- **MS-SS5**

- **MS-SS3-2**

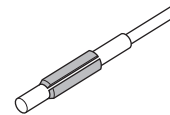
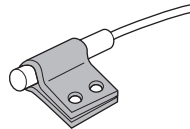

By using the C bracket, the applicable tightening force can be doubled.

SPECIFICATIONS**Non-threaded type**

Item	Model No.	Shielded type											
		Flexible cable				Flexible cable				Flexible cable			
Type		GX-3S	GX-3SB	GX-3S-R	GX-3SB-R	GX-4S	GX-4SB	GX-4S-R	GX-4SB-R	GX-5S	GX-5SB	GX-5S-R	GX-5SB-R
Max. operation distance (Note 2)		0.8 mm 0.031 in ±15 %								1 mm 0.039 in ±15 %			
Stable sensing range (Note 2)		0 to 0.6 mm 0 to 0.024 in								0 to 0.8 mm 0 to 0.031 in			
Standard sensing object		Iron sheet 5 × 5 × t 1 mm 0.197 × 0.197 × t 0.039 in								Iron sheet 6 × 6 × t 1 mm 0.236 × 0.236 × t 0.039 in			
Hysteresis		15 % or less of operation distance (with standard sensing object)											
Repeatability		20 μm 0.787 mil or less								8 μm 0.315 mil or less			
Supply voltage		12 to 24 V DC ±10 % Ripple P-P 10 % or less								10 to 30 V DC Ripple P-P 10 % or less			
Current consumption		15 mA or less											
Output		NPN open-collector transistor <ul style="list-style-type: none"> • Maximum sink current: 50 mA • Applied voltage: 30 V DC or less (between output and 0 V) • Residual voltage: 0.4 V or less (at 50 mA sink current) 								NPN open-collector transistor <ul style="list-style-type: none"> • Maximum sink current: 200 mA (Note 3) • Applied voltage: 30 V DC or less (between output and 0 V) • Residual voltage: 1.5 V or less (at 200 mA sink current) 0.4 V or less (at 50 mA sink current) 			
	Utilization category	DC-12 or DC-13											
	Output operation	Normally open	Normally closed	Normally open	Normally closed	Normally open	Normally closed	Normally open	Normally closed	Normally open	Normally closed	Normally open	Normally closed
	Short-circuit protection	—								Incorporated			
Max. response frequency		1 kHz								1.5 kHz			
Operation indicator		Red LED (lights up when the output is ON)											
Environmental resistance	Pollution degree	3 (Industrial environment)											
	Protection	IP67 (IEC)											
	Ambient temperature	-25 to +70 °C -13 to +158 °F , Storage: -25 to +80 °C -13 to +176 °F											
	Ambient humidity	35 to 95 % RH, Storage: 35 to 95 % RH								35 to 85 % RH, Storage: 35 to 95 % RH			
	EMC	EN 60947-5-2											
	Voltage withstandability	500 V AC for one min. between all supply terminals connected together and enclosure											
	Insulation resistance	5 MΩ, or more, with 250 V DC megger between all supply terminals connected together and enclosure								50 MΩ, or more, with 500 V DC megger between all supply terminals connected together and enclosure			
	Vibration resistance	10 to 55 Hz frequency, 1.5 mm 0.059 in amplitude in X, Y and Z directions for two hours each											
	Shock resistance	200 m/s ² acceleration (20 G approx.) in X, Y and Z directions for ten times each								300 m/s ² acceleration (30 G approx.) in X, Y and Z directions for ten times each			
Sensing range variation	Temperature characteristics	Over ambient temperature range -25 to +70 °C -13 to +158 °F : Within ±20 % of sensing range at +20 °C +68 °F								Over ambient temperature range -25 to +70 °C -13 to +158 °F : Within ±15 % of sensing range at +20 °C +68 °F			
	Voltage characteristics	Within ±2 % for ±10 % fluctuation of the supply voltage								Within ±2.5 % for ±15 % fluctuation of the supply voltage			
Material		Enclosure: Stainless steel (SUS304), Resin part: TPX								Enclosure: Brass (Nickel plated) Resin part: ABS			
Cable		0.08 mm ² 3-core oil, heat and cold resistant cable, 3 m 9.843 ft long	0.1 mm ² 3-core flexible, oil and heat resistant cable, 3 m 9.843 ft long	0.08 mm ² 3-core oil, heat and cold resistant cable, 3 m 9.843 ft long	0.1 mm ² 3-core flexible, oil and heat resistant cable, 3 m 9.843 ft long	0.08 mm ² 3-core oil, heat and cold resistant cable, 3 m 9.843 ft long	0.1 mm ² 3-core flexible, oil and heat resistant cable, 3 m 9.843 ft long	0.14 mm ² 3-core oil, heat and cold resistant cable, 3 m 9.843 ft long	0.15 mm ² 3-core flexible, oil and heat resistant cable, 3 m 9.843 ft long	0.14 mm ² 3-core oil, heat and cold resistant cable, 3 m 9.843 ft long	0.15 mm ² 3-core flexible, oil and heat resistant cable, 3 m 9.843 ft long	0.14 mm ² 3-core oil, heat and cold resistant cable, 3 m 9.843 ft long	0.15 mm ² 3-core flexible, oil and heat resistant cable, 3 m 9.843 ft long
Cable extension		Extension up to total 100 m 328.084 ft is possible with 0.3 mm ² , or more, cable.											
Weight		Net weight: 30 g approx.								Net weight: 55 g approx.			
Accessories		MS-SS3 (Sensor mounting bracket): 1 pc. MS-SS3-2 (C bracket): 1 pc.								MS-SS5 (Sensor mounting bracket): 1 pc.			

Notes: 1) Where measurement conditions have not been specified precisely, the conditions used were an ambient temperature of +23 °C **+73.4 °F**.

2) The maximum operation distance stands for the maximum distance for which the sensor can detect the standard sensing object.

The stable sensing range stands for the sensing range for which the sensor can stably detect the standard sensing object even if there is an ambient temperature drift and/or supply voltage fluctuation.

3) The maximum sink current varies depending on the ambient temperature. Refer to "I/O CIRCUIT AND WIRING DIAGRAMS (p.870)" for details.

FIBER SENSORS

LASER SENSORS

PHOTO-ELECTRIC SENSORS

MICRO PHOTO-ELECTRIC SENSORS

AREA SENSORS

LIGHT CURTAINS / SAFETY COMPONENTS

PRESSURE / FLOW SENSORS

INDUCTIVE PROXIMITY SENSORS

PARTICULAR USE SENSORS

SENSOR OPTIONS

SIMPLE WIRE-SAVING UNITS

WIRE-SAVING SYSTEMS

MEASUREMENT SENSORS

STATIC ELECTRICITY PREVENTION DEVICES

LASER MARKERS

PLC

HUMAN MACHINE INTERFACES

ENERGY CONSUMPTION VISUALIZATION COMPONENTS

FA COMPONENTS

MACHINE VISION SYSTEMS

UV CURING SYSTEMS

Selection Guide

Amplifier Built-in

Amplifier-separated

GX-F/H

GXL

GL

GX-M

GX-UGX-FU/GX-N

GX

FIBER SENSORS
LASER SENSORS
PHOTO-ELECTRIC SENSORS
MICRO PHOTO-ELECTRIC SENSORS
AREA SENSORS
LIGHT CURTAINS / SAFETY COMPONENTS
PRESSURE / FLOW SENSORS
INDUCTIVE PROXIMITY SENSORS
PARTICULAR USE SENSORS
SENSOR OPTIONS
SIMPLE WIRE-SAVING UNITS
WIRE-SAVING SYSTEMS
MEASUREMENT SENSORS
STATIC ELECTRICITY PREVENTION DEVICES
LASER MARKERS
PLC
HUMAN MACHINE INTERFACES
ENERGY CONSUMPTION VISUALIZATION COMPONENTS
FA COMPONENTS
MACHINE VISION SYSTEMS
UV CURING SYSTEMS
Selection Guide
Amplifier Built-in
Amplifier-separated
GX-F/H
GXL
GL
GX-M
GX-U/GX-FU/
GX-N
GX

SPECIFICATIONS

Threaded type

Item	Type	Shielded type								Non-shielded type	
		Flexible cable				Flexible cable				GX-8ML	GX-8MLB
Model No.	GX-5M	GX-5MB	GX-5M-R	GX-5MB-R	GX-8M	GX-8MB	GX-8M-R	GX-8MB-R			
Max. operation distance (Note 2)		0.8 mm 0.031 in ±15 %				1 mm 0.039 in ±15 %				2 mm 0.079 in ±15 %	
Stable sensing range (Note 2)		0 to 0.6 mm 0 to 0.024 in				0 to 0.8 mm 0 to 0.031 in				0 to 1.6 mm 0 to 0.063 in	
Standard sensing object		Iron sheet 5 × 5 × t 1 mm 0.197 × 0.197 × t 0.039 in				Iron sheet 8 × 8 × t 1 mm 0.315 × 0.315 × t 0.039 in				Iron sheet 12 × 12 × t 1 mm 0.472 × 0.472 × t 0.039 in	
Hysteresis		15 % or less of operation distance (with standard sensing object)				10 % or less of operation distance (with standard sensing object)					
Repeatability		20 μm 0.787 mil or less				8 μm 0.315 mil or less				40 μm 1.575 mil or less	
Supply voltage		12 to 24 V DC ±10 % Ripple P-P 10 % or less				10 to 30 V DC Ripple P-P 10 % or less					
Current consumption						15 mA or less					
Output		NPN open-collector transistor • Maximum sink current: 50 mA • Applied voltage: 30 V DC or less (between output and 0V) • Residual voltage: 0.4 V or less (at 50 mA sink current)				NPN open-collector transistor • Maximum sink current: 200 mA (Note 3) • Applied voltage: 30 V DC or less (between output and 0 V) • Residual voltage: 1.5 V or less (at 200 mA sink current) 0.4 V or less (at 50 mA sink current)					
	Utilization category	DC-12 or DC-13									
	Output operation	Normally open	Normally closed	Normally open	Normally closed	Normally open	Normally closed	Normally open	Normally closed	Normally open	Normally closed
Short-circuit protection					Incorporated						
Max. response frequency		1 kHz				500 Hz					
Operation indicator		Red LED (lights up when the output is ON)									
Environmental resistance	Pollution degree	3 (Industrial environment)									
	Protection	IP67 (IEC)									
	Ambient temperature	- 25 to +70 °C -13 to +158 °F , Storage: - 25 to +80 °C - 13 to +176 °F									
	Ambient humidity	35 to 95 % RH, Storage: 35 to 95 % RH				35 to 85 % RH, Storage: 35 to 95 % RH					
	EMC	EN 60947-5-2									
	Voltage withstandability	500 V AC for one min. between all supply terminals connected together and enclosure									
	Insulation resistance	5 MΩ, or more, with 250 V DC megger between all supply terminals connected together and enclosure				50 MΩ, or more, with 500 V DC megger between all supply terminals connected together and enclosure					
	Vibration resistance	10 to 55 Hz frequency, 1.5 mm 0.059 in amplitude in X, Y and Z directions for two hours each									
Shock resistance	200 m/s ² acceleration (20 G approx.) in X, Y and Z directions for ten times each				300 m/s ² acceleration (30 G approx.) in X, Y and Z directions for ten times each				300 m/s ² acceleration (30 G approx.) in X, Y and Z directions for three times each		
Sensing range variation	Temperature characteristics	Over ambient temperature range - 25 to +70 °C -13 to +158 °F : Within ±20 % of sensing range at +20 °C +68 °F				Over ambient temperature range -25 to +70 °C -13 to +158 °F : Within $\pm 15\%$ % of sensing range at +20 °C +68 °F					
	Voltage characteristics	Within ±2 % for ±10 % fluctuation of the supply voltage				Within ±2.5 % for ±15 % fluctuation of the supply voltage					
Material		Enclosure: Brass (Nickel plated) Resin part: TPX				Enclosure: Brass (Nickel plated) Resin part: ABS					
Cable		0.08 mm ² 3-core oil, heat and cold resistant cabtyre cable, 3 m 9.843 ft long		0.1 mm ² 3-core flexible, oil and heat resistant cabtyre cable, 3 m 9.843 ft long		0.14 mm ² 3-core oil, heat and cold resistant cabtyre cable, 3 m 9.843 ft long		0.15 mm ² 3-core flexible, oil and heat resistant cabtyre cable, 3 m 9.843 ft long		0.14 mm ² 3-core, oil, heat and cold resistant cabtyre cable, 3 m 9.843 ft long	
Cable extension		Extension up to total 100 m 328.084 ft is possible with 0.3 mm ² , or more, cable.								Extension up to total 100 m 328.084 ft is possible with 0.14 mm ² , or more, cable.	
Weight (Note 4)		Net weight: 30 g approx.				Net weight: 60 g approx.					
Accessories		Nut: 2 pcs. Toothed lock washer: 1 pc.		Nut: 2 pcs. Toothed lock washer: 2 pcs.		Nut: 2 pcs. Toothed lock washer: 1 pc.		Nut: 2 pcs. Toothed lock washer: 2 pcs.		Nut: 2 pcs. Toothed lock washer: 1 pc.	

Notes: 1) Where measurement conditions have not been specified precisely, the conditions used were an ambient temperature of +23 °C **+73.4 °F**.
 2) The maximum operation distance stands for the maximum distance for which the sensor can detect the standard sensing object.
 The stable sensing range stands for the sensing range for which the sensor can stably detect the standard sensing object even if there is an ambient temperature drift and/or supply voltage fluctuation.
 3) The maximum sink current varies depending on the ambient temperature. Refer to "I/O CIRCUIT AND WIRING DIAGRAMS (p.870)" for details.
 4) The given weight of the threaded type includes the weight of two nuts and one toothed lock washer.

I/O CIRCUIT AND WIRING DIAGRAMS

GX-5S □ GX-8M □ GX-8ML □

I/O circuit diagram

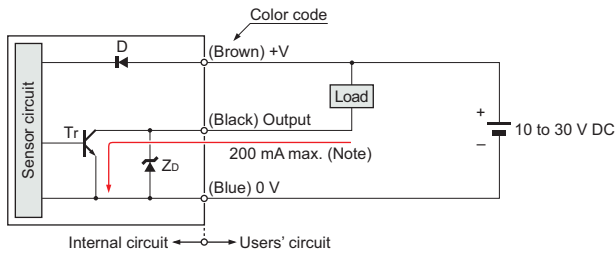

Symbols ... D : Reverse supply polarity protection diode
 Zd: Surge absorption zener diode
 Tr : NPN output transistor

- If a capacitor of 1 μF or more is connected between 0 V and output or between +V and output, connect a 100 Ω resistor in series as shown below.

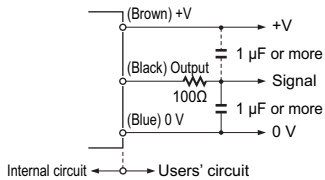

Without the resistor, the short-circuit protection is activated by the charge or discharge current of the capacitor, so that it results in delaying the response whenever the sensor switches. The connected resistor solves this problem.

Wiring diagram

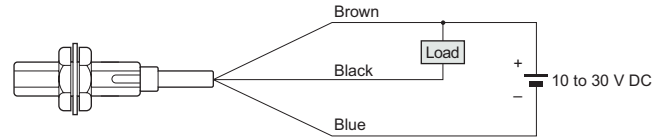

Note: The maximum sink current varies depending on the ambient temperature.

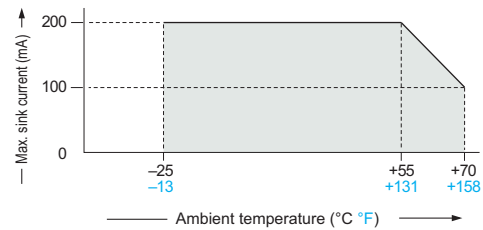

GX-3S □ GX-4S □ GX-5M □

I/O circuit diagram

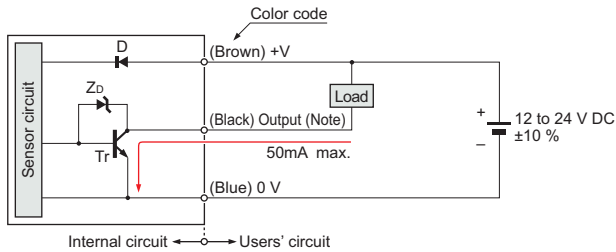

Note: **GX-3S**, **GX-4S** and **GX-5M** do not incorporate a short-circuit protection circuit at the output. Do not connect them directly to a power supply or a capacitive load.

Symbols ... D : Reverse supply polarity protection diode
 Zd: Surge absorption zener diode
 Tr : NPN output transistor

Wiring diagram

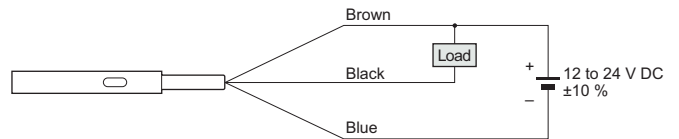

FIBER SENSORS

LASER SENSORS

PHOTO-ELECTRIC SENSORS

MICRO PHOTO-ELECTRIC SENSORS

AREA SENSORS

LIGHT CURTAINS / SAFETY COMPONENTS

PRESSURE / FLOW SENSORS

INDUCTIVE PROXIMITY SENSORS

PARTICULAR USE SENSORS

SENSOR OPTIONS

WIRE-SAVING UNITS

WIRE-SAVING SYSTEMS

MEASUREMENT SENSORS

STATIC ELECTRICITY PREVENTION DEVICES

LASER MARKERS

PLC

HUMAN MACHINE INTERFACES

ENERGY CONSUMPTION VISUALIZATION COMPONENTS

FA COMPONENTS

MACHINE VISION SYSTEMS

UV CURING SYSTEMS

Selection Guide

Amplifier Built-in

Amplifier-separated

GX-F/H

GXL

GL

GX-M

GX-U/GX-FU/GX-N

GX

- FIBER SENSORS
- LASER SENSORS
- PHOTO-ELECTRIC SENSORS
- MICRO PHOTO-ELECTRIC SENSORS
- AREA SENSORS
- LIGHT CURTAINS/SAFETY COMPONENTS
- PRESSURE / FLOW SENSORS
- INDUCTIVE PROXIMITY SENSORS
- PARTICULAR USE SENSORS
- SENSOR OPTIONS
- SIMPLE WIRE-SAVING UNITS
- WIRE-SAVING SYSTEMS
- MEASUREMENT SENSORS
- STATIC ELECTRICITY PREVENTION DEVICES
- LASER MARKERS
- PLC
- HUMAN MACHINE INTERFACES
- ENERGY CONSUMPTION VISUALIZATION COMPONENTS
- FA COMPONENTS
- MACHINE VISION SYSTEMS
- UV CURING SYSTEMS
- Selection Guide
- Amplifier Built-in
- Amplifier-separated
- GX-F/H
- GXL
- GL
- GX-M
- GX-U/GX-FU/GX-N
- GX**

SENSING CHARACTERISTICS (TYPICAL)

GX-3S □ GX-4S □ GX-5M □

Sensing field

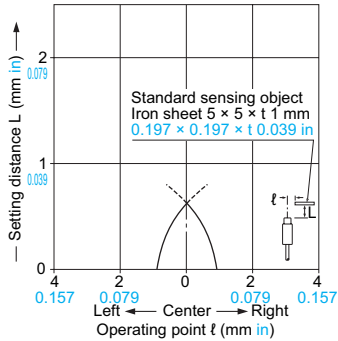

Correlation between sensing object size and sensing range

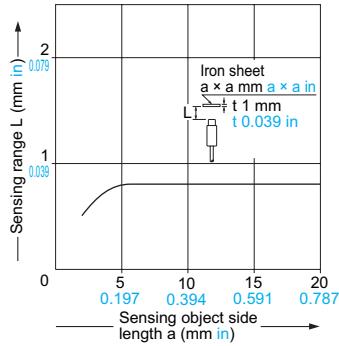

As the sensing object size becomes smaller than the standard size (iron sheet 5 × 5 × t 1 mm 0.197 × 0.197 × t 0.039 in), the sensing range shortens as shown in the left figure.

GX-5S □

Sensing field

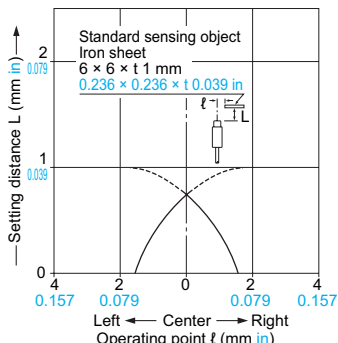

Correlation between sensing object size and sensing range

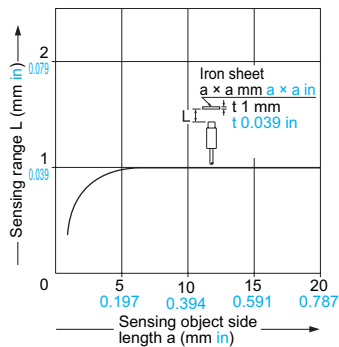

As the sensing object size becomes smaller than the standard size (iron sheet 6 × 6 × t 1 mm 0.236 × 0.236 × t 0.039 in), the sensing range shortens as shown in the left figure.

GX-8M □

Sensing field

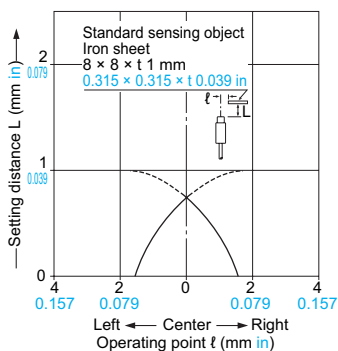

Correlation between sensing object size and sensing range

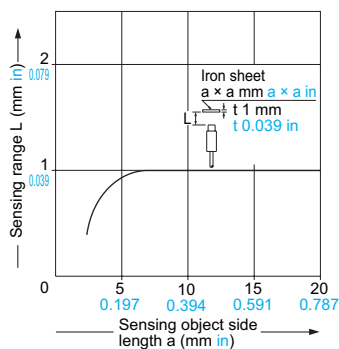

As the sensing object size becomes smaller than the standard size (iron sheet 8 × 8 × t 1 mm 0.315 × 0.315 × t 0.039 in), the sensing range shortens as shown in the left figure.

GX-8ML □

Sensing field

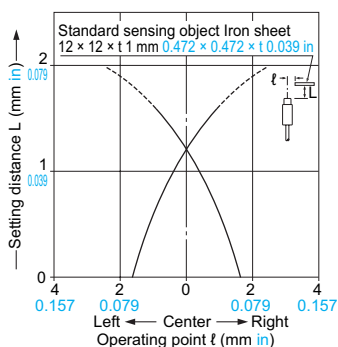

Correlation between sensing object size and sensing range

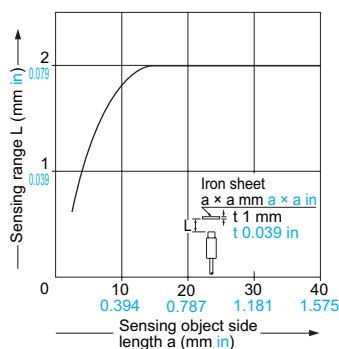

As the sensing object size becomes smaller than the standard size (iron sheet 12 × 12 × t 1 mm 0.472 × 0.472 × t 0.039 in), the sensing range shortens as shown in the left figure.

PRECAUTIONS FOR PROPER USE

Refer to p.1485~ for general precautions.

FIBER SENSORS

LASER SENSORS

PHOTO-ELECTRIC SENSORS

MICRO PHOTO-ELECTRIC SENSORS

AREA SENSORS

LIGHT CURTAINS / SAFETY COMPONENTS

PRESSURE / FLOW SENSORS

INDUCTIVE PROXIMITY SENSORS

PARTICULAR USE SENSORS

SENSOR OPTIONS

SIMPLE WIRE-SAVING UNITS

WIRE-SAVING SYSTEMS

MEASUREMENT SENSORS

STATIC ELECTRICITY PREVENTION DEVICES

LASER MARKERS

PLC

HUMAN MACHINE INTERFACES

ENERGY CONSUMPTION VISUALIZATION COMPONENTS

FA COMPONENTS

MACHINE VISION SYSTEMS

UV CURING SYSTEMS

Selection Guide

Amplifier Built-in

Amplifier-separated

GX-F/H

GXL

GL

GX-M

GX-U/GX-FU/GX-N

GX



- Never use this product as a sensing device for personnel protection.
- In case of using sensing devices for personnel protection, use products which meet laws and standards, such as OSHA, ANSI or IEC etc., for personnel protection applicable in each region or country.

Mounting

- The tightening torque should be as given below.

Mounting with set screw

<Shielded of threaded type>

- Tighten the set screw on the flat surface of the sensor without applying excessive force. Make sure to use a set screw with a cup-point end.

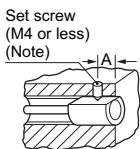

Note: To fasten **GX-5M□**, use a M3 or less set screw.

Model No.	Set screw tightening position A (mm in)	Tightening torque
GX-5M□	5 to 10 0.197 to 0.394	0.29 N·m
GX-8M□	8 to 22 0.315 to 0.866	0.29 N·m

<Non-threaded type and non-shielded of threaded type>

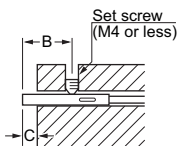

Model No.	B (mm in)	C (mm in)	Tightening torque
GX-3S□	5 to 10 0.197 to 0.394	3 0.118	0.29 N·m
			0.58 N·m
GX-4S□	5 to 10 0.197 to 0.394	3 0.118	0.58 N·m
GX-5S□	8 to 20 0.315 to 0.787	5 0.197	0.29 N·m
GX-8ML□	13 to 22 0.517 to 0.866	10 0.394	0.29 N·m

Note: The protrusion should be kept C (mm in) or more to avoid reduction of sensing range.

- To fasten **GX-3S□** and **GX-4S□**, use a M3 or less set screw and tighten it from a direction perpendicular to the operation indicator.

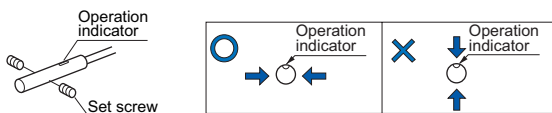

- When using the C bracket, place it on the sensor at a distance of 3 mm **0.118 in** or more from the sensor end.

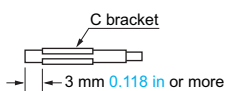

- To fasten the non-shielded threaded type, tighten the set screw on the flat surface of the sensor.

Mounting with nut

- Note that the maximum tightening torque differs according to the location of the nuts.

<Shielded of threaded type>

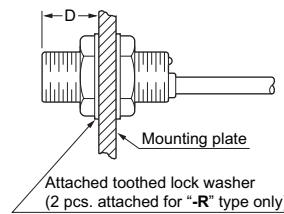

<Non-shielded of threaded type>

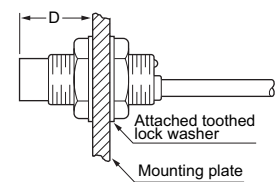

Model No.	D (mm in)	Tightening torque
GX-5M□	2 to 3 0.079 to 0.118	0.49 N·m
	3 0.118 or more	1.47 N·m
GX-8M□	3 to 11 0.118 to 0.433	1.47 N·m
	11 0.433 or more	3.43 N·m
GX-8ML□	9 to 11 0.345 to 0.433	0.98 N·m
	11 0.433 or more	3.43 N·m

Note: Mount such that the nuts do not protrude from the threaded portion.

- The root truncation of the threads with **GX-8M□** and **GX-8ML□** is shallow owing to strengthening of the sensors against tightening. When tapping holes on equipment to fix the sensors, the prepared holes must be $\varnothing 7.2$ mm **$\varnothing 0.283$ in** or more.

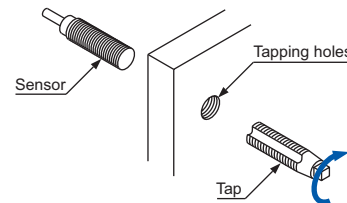

- FIBER SENSORS
- LASER SENSORS
- PHOTO-ELECTRIC SENSORS
- MICRO PHOTO-ELECTRIC SENSORS
- AREA SENSORS
- LIGHT CURTAINS/SAFETY COMPONENTS
- PRESSURE / FLOW SENSORS
- INDUCTIVE PROXIMITY SENSORS**
- PARTICULAR USE SENSORS
- SENSOR OPTIONS
- SIMPLE WIRE-SAVING UNITS
- WIRE-SAVING SYSTEMS
- MEASUREMENT SENSORS
- STATIC ELECTRICITY PREVENTION DEVICES
- LASER MARKERS
- PLC
- HUMAN MACHINE INTERFACES
- ENERGY CONSUMPTION VISUALIZATION COMPONENTS
- FA COMPONENTS
- MACHINE VISION SYSTEMS
- UV CURING SYSTEMS
- Selection Guide
- Amplifier Built-in
- Amplifier-separated
- GX-F/H
- GXL
- GL
- GX-M
- GX-U/GX-FU/GX-N
- GX**

PRECAUTIONS FOR PROPER USE

Refer to p.1485~ for general precautions.

Distance from surrounding metal

- As metal around the sensor may affect the sensing performance, pay attention to the following points.

Influence of surrounding metal

- The surrounding metal will affect the sensing performance. Keep the minimum distance specified in the table below.

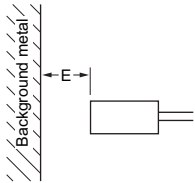

Model No.	E (mm in)
GX-3S □	3 0.118
GX-4S □	3 0.118
GX-5S □	4 0.157
GX-5M □	3 0.118
GX-8M □	4 0.157
GX-8ML □	8 0.315

Embedding of the sensor in metal

- Sensing range may decrease if the sensor is completely embedded in metal. Especially for the non-threaded type and the non-shielded type, keep the minimum distance specified in the table below.

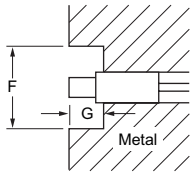

Model No.	F (mm in)	G (mm in)
GX-3S □	ø12 ø0.472	3 0.118
GX-4S □	ø12 ø0.472	3 0.118
GX-5S □	ø15.4 ø0.606	5 0.197
GX-8ML □	ø30 ø1.181	10 0.394

Mutual interference

- When two or more sensors are installed in parallel or face to face, keep the minimum separation distance specified below to avoid mutual interference.

Face to face mounting

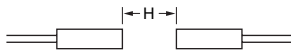

Model No.	H (mm in)	J (mm in)
GX-3S □	16 0.630	16 0.630
GX-4S □	16 0.630	16 0.630
GX-5S □	20 0.787	15 0.591
GX-5M □	10 0.394	10 0.394
GX-8M □	20 0.787	15 0.591
GX-8ML □	50 1.969	30 1.181

Parallel mounting



Sensing range

- The sensing range is specified for the standard sensing object. With a non-ferrous metal, the sensing range is obtained by multiplying with the correction coefficient specified below. Further, the sensing range also changes if the sensing object is smaller than the standard sensing object or if the sensing object is plated.

Correction coefficient

Model No.	Correction Coefficient		
	GX-3S □ GX-4S □	GX-5M □	GX-5S □ GX-8M □ GX-8ML □
Metal			
Iron	1	1	1
Stainless steel (SUS304)	0.65 approx.	0.83 approx.	0.7 approx.
Brass	0.36 approx.	0.61 approx.	0.4 approx.
Aluminum	0.30 approx.	0.58 approx.	0.35 approx.

Others

- Do not use during the initial transient time (10 ms) after the power supply is switched on.
- Make sure that stress by forcible bend or pulling is not applied directly to the sensor cable joint.
- GX-3S**□, **GX-4S**□ and **GX-5M**□ do not incorporate a short-circuit protection circuit at the output. Do not connect them directly to a power supply or a capacitive load.

DIMENSIONS (Unit: mm in)

The CAD data in the dimensions can be downloaded from our website.

GX-3S□ Sensor

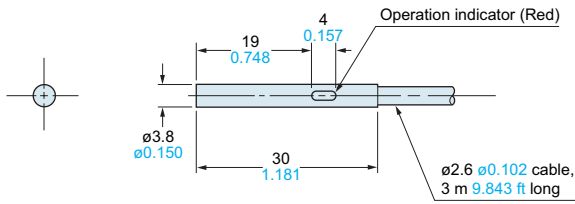

GX-4S□ Sensor

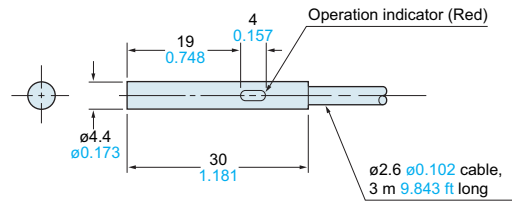

GX-5S□ Sensor

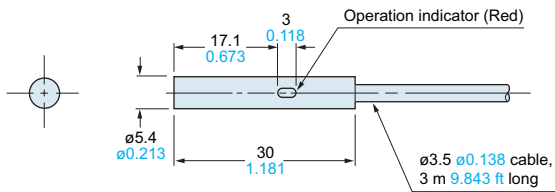

GX-5M□ Sensor

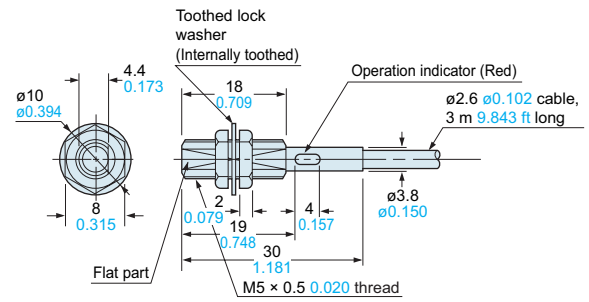

GX-8M□ Sensor

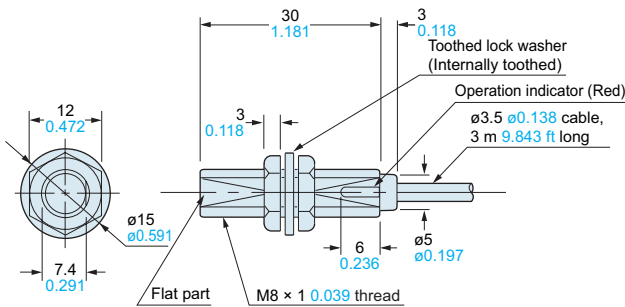

GX-8ML□ Sensor

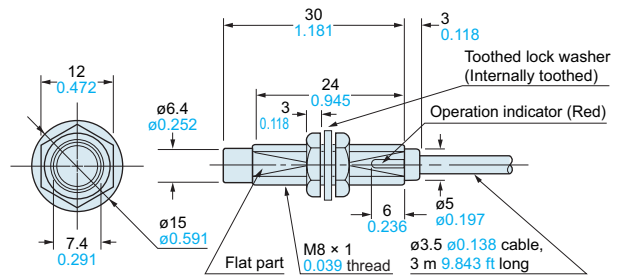

MS-SS3-2 C bracket for GX-3S□ (Accessory for GX-3S□)

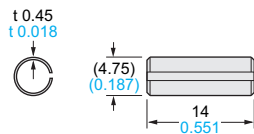

Note: By using the C bracket, the applicable tightening force can be doubled.

MS-SS3 Sensor mounting bracket for GX-3S□ (Accessory for GX-3S□)
MS-SS5 Sensor mounting bracket for GX-5S□ (Accessory for GX-5S□)

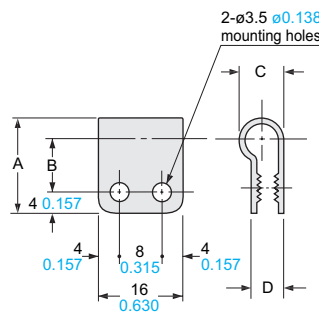

Material: Nylon 66

Model No.	MS-SS3	MS-SS5
Symbol		
A	16 0.630	18 0.709
B	9 0.354	10 0.394
C	6.3 0.248	8.3 0.327
D	4.9 0.193	6.1 0.240
Applicable model No.	GX-3S□	GX-5S□

- FIBER SENSORS
- LASER SENSORS
- PHOTO-ELECTRIC SENSORS
- MICRO PHOTO-ELECTRIC SENSORS
- AREA SENSORS
- LIGHT CURTAINS / SAFETY COMPONENTS
- PRESSURE / FLOW SENSORS
- INDUCTIVE PROXIMITY SENSORS
- PARTICULAR USE SENSORS
- SENSOR OPTIONS
- WIRE-SAVING UNITS
- WIRE-SAVING SYSTEMS
- MEASUREMENT SENSORS
- STATIC ELECTRICITY PREVENTION DEVICES
- LASER MARKERS
- PLC
- HUMAN MACHINE INTERFACES
- ENERGY CONSUMPTION VISUALIZATION COMPONENTS
- FA COMPONENTS
- MACHINE VISION SYSTEMS
- UV CURING SYSTEMS

- Selection Guide
- Amplifier Built-in
- Amplifier-separated
- GX-F/H
- GXL
- GL
- GX-M
- GX-U/GX-FU/GX-N
- GX