

## Connector - SACC-FSB-5SC SH SCO - 1432703

Please be informed that the data shown in this PDF Document is generated from our Online Catalog. Please find the complete data in the user's documentation. Our General Terms of Use for Downloads are valid (<http://phoenixcontact.com/download>)



Connector, 5-position, shielded, Socket straight M12 SPEEDCON, B-coded, Spring-cage connection, knurl material: Zinc die-cast, nickel-plated, external cable diameter 4 mm ... 8 mm

### Why buy this product

- ✓ Safe use in the field, thanks to a high degree of protection
- ✓ Flexible: connectors for on-site assembly
- ✓ Save time, thanks to installation with SPEEDCON fast locking system
- ✓ Spring-cage connection: connect more securely, even in the case of shock and vibration, thanks to high contact forces
- ✓ Reliable signal transmission - 360° shielding in environments with electromagnetic interference



### Key Commercial Data

Packing unit	1 STK
GTIN	 4 046356 348393
GTIN	4046356348393

### Technical data

#### Dimensions

External cable diameter	4 mm ... 8 mm
Stripping length of the sheath	33 mm
Stripping length of the individual wire	10 mm

#### Ambient conditions

Ambient temperature (operation)	-40 °C ... 85 °C (Plug / socket)
Degree of protection	IP67

#### General

Rated current at 40°C	4 A
Rated voltage	60 V DC
	48 V AC
Number of positions	5

# Connector - SACC-FSB-5SC SH SCO - 1432703

## Technical data

### General

Insulation resistance	≥ 100 MΩ
Coding	B-coded
Standards/regulations	M12 connector IEC 61076-2-101
	Shock, vibration EN 50155:2001
Status display	No
Overvoltage category	II
Degree of pollution	3
Connection method	Spring-cage connection
Conductor cross section	0.14 mm <sup>2</sup> ... 0.5 mm <sup>2</sup>
Conductor cross section AWG	26 ... 20
Insertion/withdrawal cycles	≥ 100
Torque	0.4 Nm (M12 knurl)
	0.8 Nm (Connector with coupling sleeve)
	3 Nm (Pressure nut with coupling sleeve)
Assembly instructions	AWG 18 wire cross section upon request
	The wires can be connected both with ferrules and without ferrules

### Material

Flammability rating according to UL 94	V0
Contact material	CuSn
Contact surface material	Ni/Au
Contact carrier material	TPU
Material of grip body	Zinc die-cast, nickel-plated
Material, knurls	Zinc die-cast, nickel-plated
Sealing material	NBR

### Cable

Standards/specifications	M12 connector IEC 61076-2-101
	Shock, vibration EN 50155:2001

### Standards and Regulations

Standard designation	M12 connector
Standards/regulations	IEC 61076-2-101
Standard designation	Shock, vibration
Standards/regulations	EN 50155:2001
Connection in acc. with standard	CUL
Flammability rating according to UL 94	V0

### Environmental Product Compliance

China RoHS	Environmentally friendly use period: unlimited = EFUP-e
	No hazardous substances above threshold values

## Drawings

# Connector - SACC-FSB-5SC SH SCO - 1432703

Schematic diagram

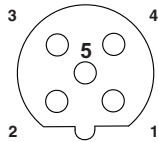

Pin assignment M12 socket, 5-pos., B-coded, female side

Functional drawing

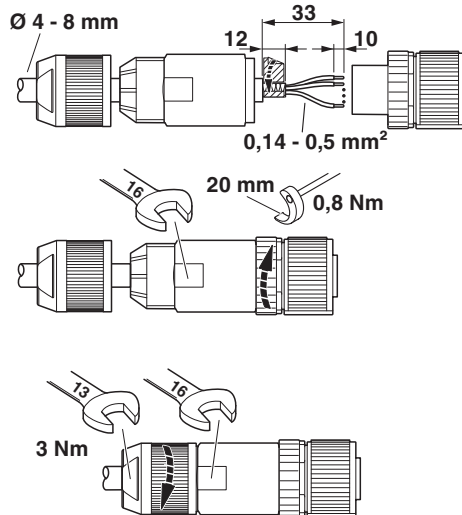

Slide the pressure nut and sleeve housing along the cable, strip the cable, shorten the shield, strip the single wires, connect the wires, in the case of a straight sleeve housing gently twist the wires together, stick the shielding foil around the shortened shield, in the case of a cable outside diameter < 6 mm stick an additional shielding foil around the wire pack, screw the sleeve housing to the plug insert, screw the pressure nut tight.

Dimensional drawing

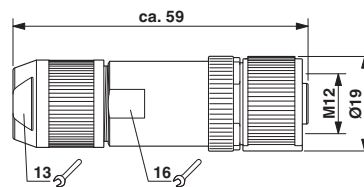

Socket M12-SPEEDCON, straight, shielded

## Approvals

Approvals

Approvals

UL Recognized / cUL Recognized / EAC / cULus Recognized

Ex Approvals

## Approval details

# Connector - SACC-FSB-5SC SH SCO - 1432703

## Approvals

UL Recognized		<a href="http://database.ul.com/cgi-bin/XYV/template/LISEXT/1FRAME/index.htm">http://database.ul.com/cgi-bin/XYV/template/LISEXT/1FRAME/index.htm</a>	FILE E 118976
Nominal voltage UN		125 V	
Nominal current IN		4 A	

cUL Recognized		<a href="http://database.ul.com/cgi-bin/XYV/template/LISEXT/1FRAME/index.htm">http://database.ul.com/cgi-bin/XYV/template/LISEXT/1FRAME/index.htm</a>	FILE E 118976
Nominal voltage UN		125 V	
Nominal current IN		4 A	

EAC		EAC-Zulassung
-----	--	---------------

cULus Recognized		<a href="http://database.ul.com/cgi-bin/XYV/template/LISEXT/1FRAME/index.htm">http://database.ul.com/cgi-bin/XYV/template/LISEXT/1FRAME/index.htm</a>
------------------	---	---

Phoenix Contact 2018 © - all rights reserved  
<http://www.phoenixcontact.com>

PHOENIX CONTACT GmbH & Co. KG  
Flachsmarktstr. 8  
32825 Blomberg  
Germany  
Tel. +49 5235 300  
Fax +49 5235 3 41200  
<http://www.phoenixcontact.com>