

ACT88320EVK1-101 User's Guide

Description

This document describes the characteristic and operation of the Active Semi ACT88320EVK1-101 evaluation kit (EVK). It provides setup and operation instructions, schematic, layout, BOM, and test data. This EVK demonstrates the ACT88320Q101 ActivePMU power management IC. Other ACT88320Qlxxx options can be evaluated on this EVK by replacing the IC and any other necessary components.

Features

The EVK can be used as a standalone board if desired. However, to access the internal registers and to take full advantage of the IC's capability, the user must connect the EVK kit to a PC with Active Semi's USB-TO-I2C interface dongle and use the GUI software. The EVK provides full access to the each converter's input and output voltage, as well as all the digital control signals. This gives the user the flexibility to configure the EVK to match their real world system.

Note that the ACT88320EVK1-101 is specifically configured for the ACT88320Q101. This IC does not use Push-Button.

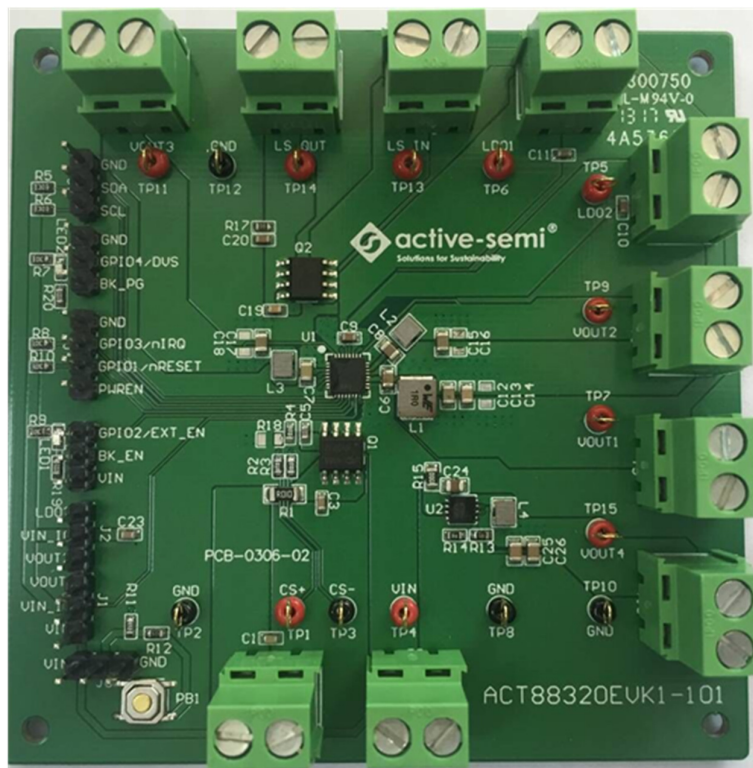

Figure 1 – EVK Picture

Setup

Required Equipment

ACT88320 EVK

USB-TO-I2C Dongle

Power supply – 5V @ 4A for full power operation

Oscilloscope – >100MHz, >2 channels

Loads – Electronic or resistive. 2.5A minimum current capability.

Digital Multimeters (DMM)

Windows compatible computer with spare USB port.

EVK Setup

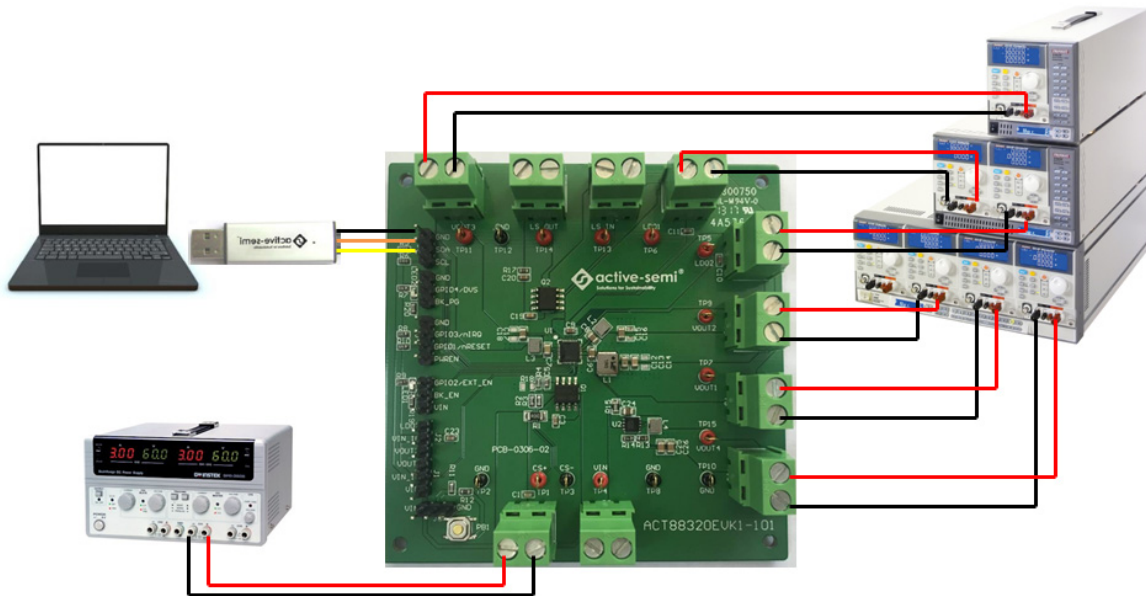
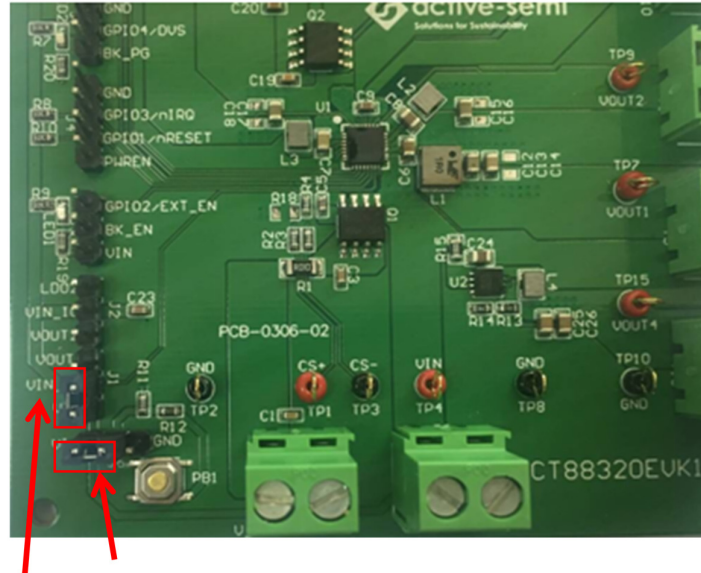

Figure 2 – EVK Setup

Hardware Setup

1. Decide which voltage will power VIO_IN. Active Semi recommends powering VIO_IN from the VIN input. Connect a shorting jumper between J1-2 and J2-3 header to power VIO_IN from the VIN input voltage. Connect a shorting jumper between J6-1 and J6-2 header to pull PWREN high rather than floating.



Apply shorting jumper in these locations

Figure 3 – Shorting Jumper Settings

2. Connect a lab supply between T1-1 and T1-2 to power VIN.
3. Connect an appropriate load to each power supply output.
4. Note that the typical setup is to apply the same 5V input voltage to all inputs. Using different input voltage sources requires careful consideration of startup sequencing.

GUI Setup (optional)

1. Refer to the end of this document for detailed instructions to install the ACT88320 GUI.
2. Connect the USB-TO-I2C dongle to the computer via a USB cable.
3. Connect the USB-TO-I2C dongle to the EVK J3 connector. Refer to Figure 4 to ensure the correct polarity of the connection. As a guide, use the “Active-Semi” logo on the top of the dongle so the black wire is connected toward the lower left corner of the Dongle.

Dongle Cable Connector
 (Black Wire Connected to GND
 of the J3 I²C jumper on the
 ACT88320 EVK board)

Dongle Cable Connector
 (Black Wire Connected to GND)

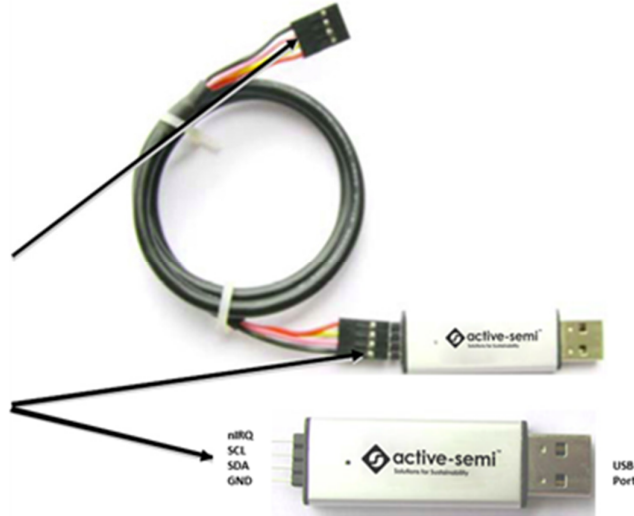

Figure 4 – USB-TO-I2C Dongle Connection

Recommended Operating Conditions

The ACT88320EVK1-101 is designed for a 5V input voltage. The maximum operating voltage is determined by the IC's maximum input voltage rating. The minimum operating voltages are determined by the buck converters' minimum input voltage and by the LDOs' dropout voltages. Maximum currents are determined by the IC's CMI settings, which can be changed via I2C after startup.

Table 1. Recommended Operating Conditions

Parameter	Description	Min	Typ	Max	Unit
VIN	All buck input voltages	2.8	5	5.5	V
I _{B1_max}	Maximum Buck 1 load current		4.0		A
I _{B2_max}	Maximum Buck 2 load current		2.0		A
I _{B3_max}	Maximum Buck 3 load current		2.0		A
I _{LDO1_max}	Maximum LDO 1 load current		0.2		A
I _{LDO2_max}	Maximum LDO 2 load current		0.2		A

EVK Operation

Turnon

Apply the 5V input voltage. All outputs automatically turn on with the programmed startup sequence.

DVS

Only Buck3 is configured for DVS operation by default. Drive GPIO4/DVS to a logic H for normal operation. Drive it low to enter DVS mode. GPIO4 is pulled up to VIN_IO and defaults to a logic H.

Test Results

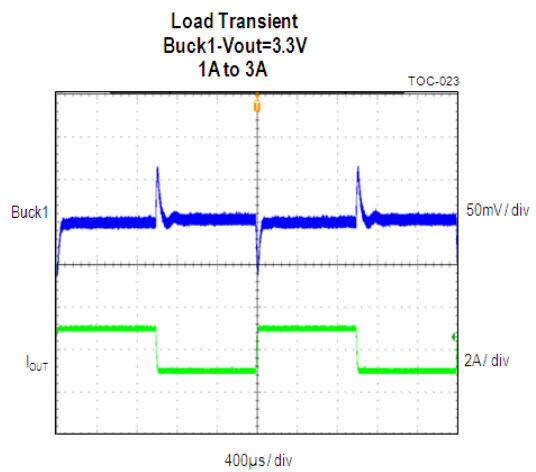
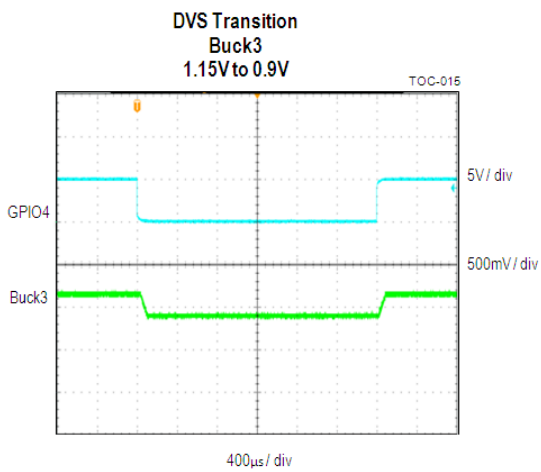
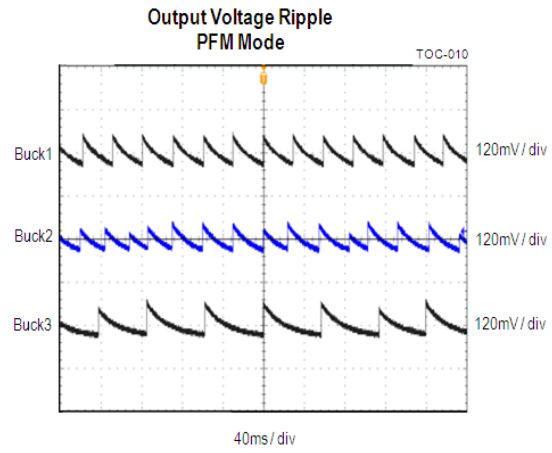
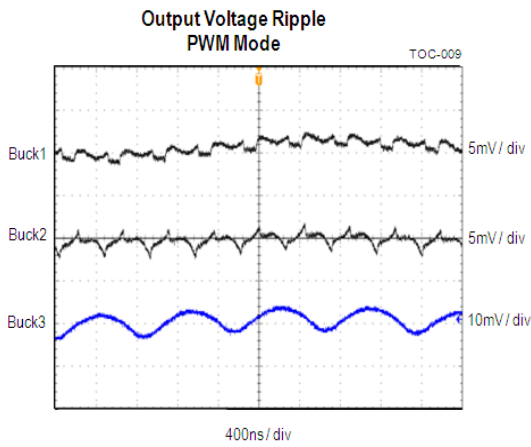
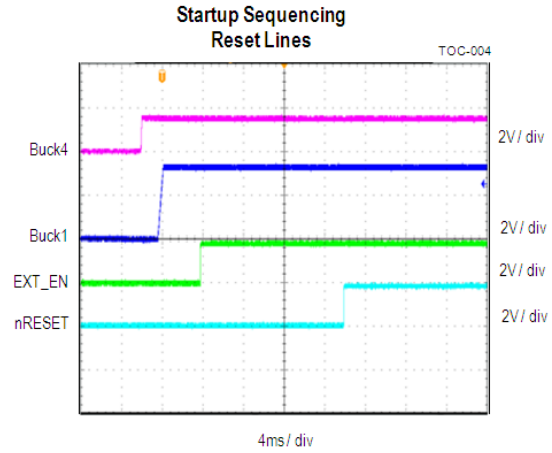
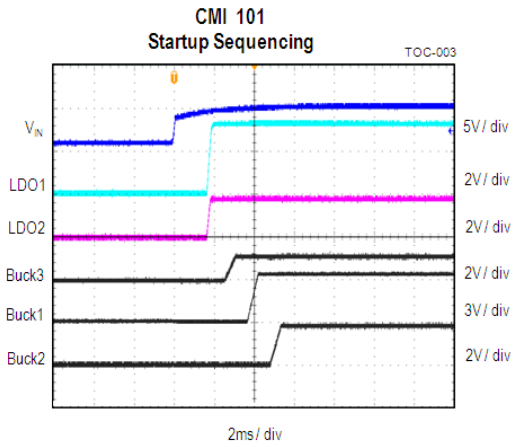

Load Transient
Buck2-Vout=1.8V
500mA to 1500mA

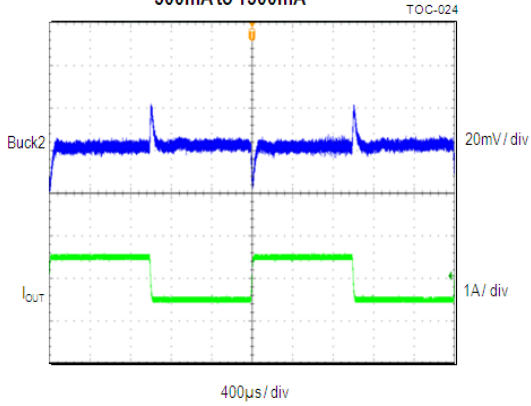

Load Transient
Buck3-Vout=1.15V
375mA to 1125mA



Load Transient
LDO1-Vout=3.3V
50mA to 150mA

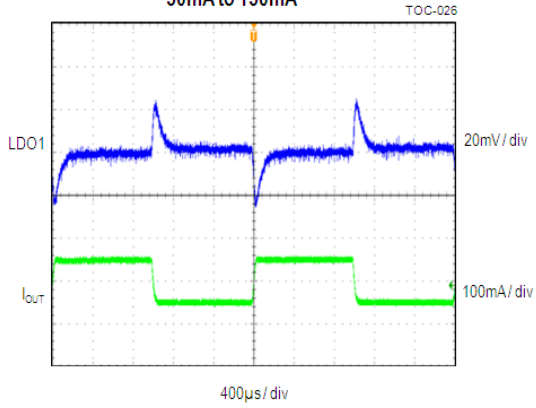

Load Transient
LDO2-Vout=1.8V
37.5mA to 112.5mA

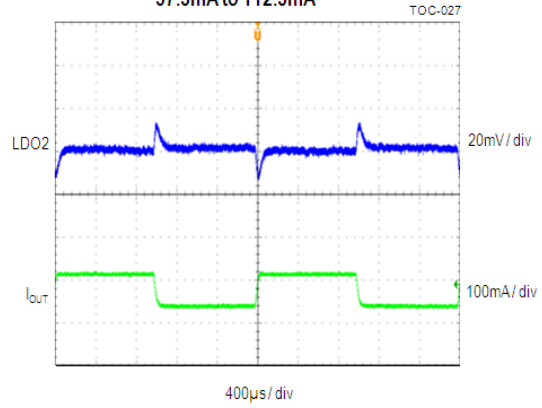

Schematic

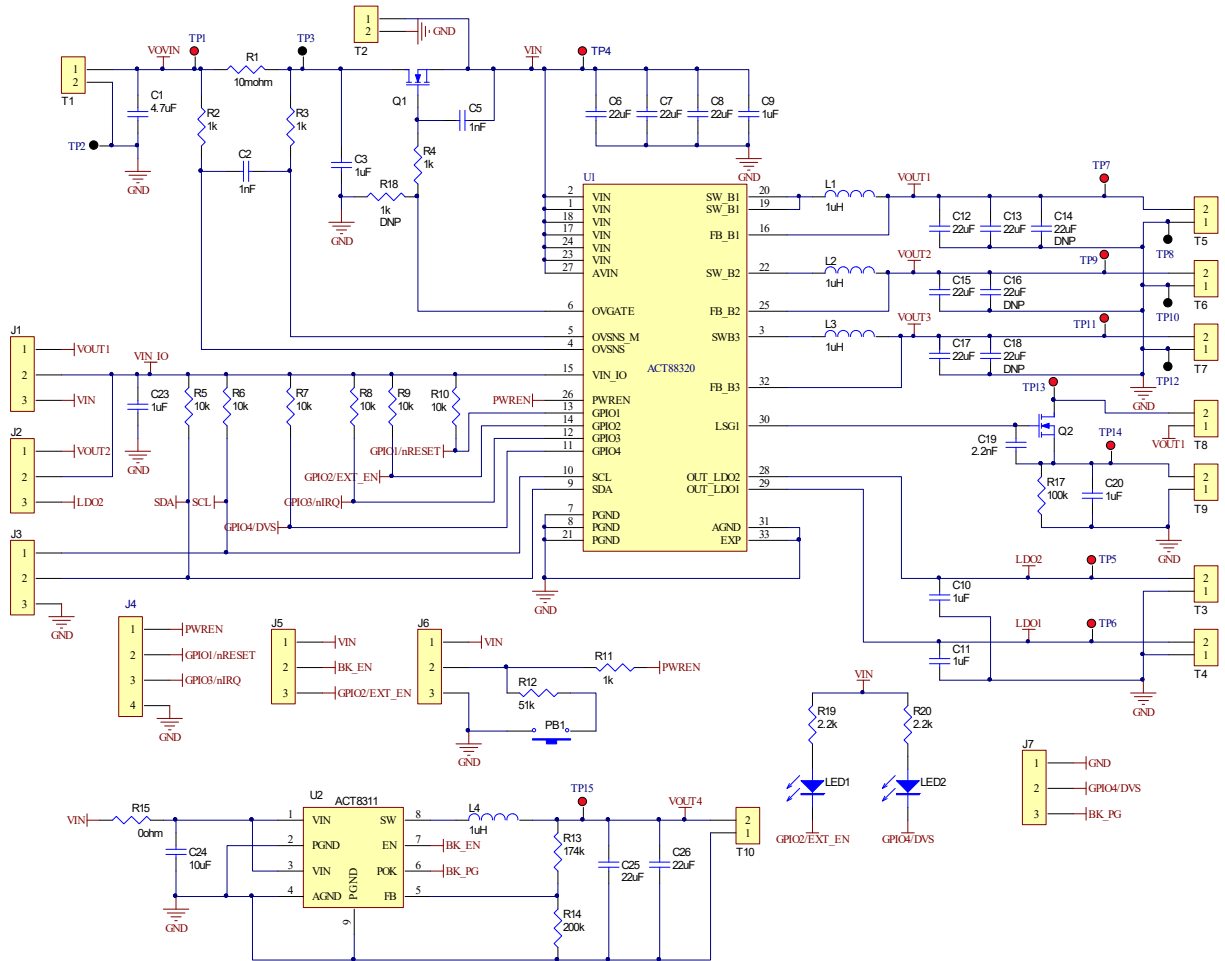

Figure 5 – ACT88320EVK1-101 Schematic

Layout

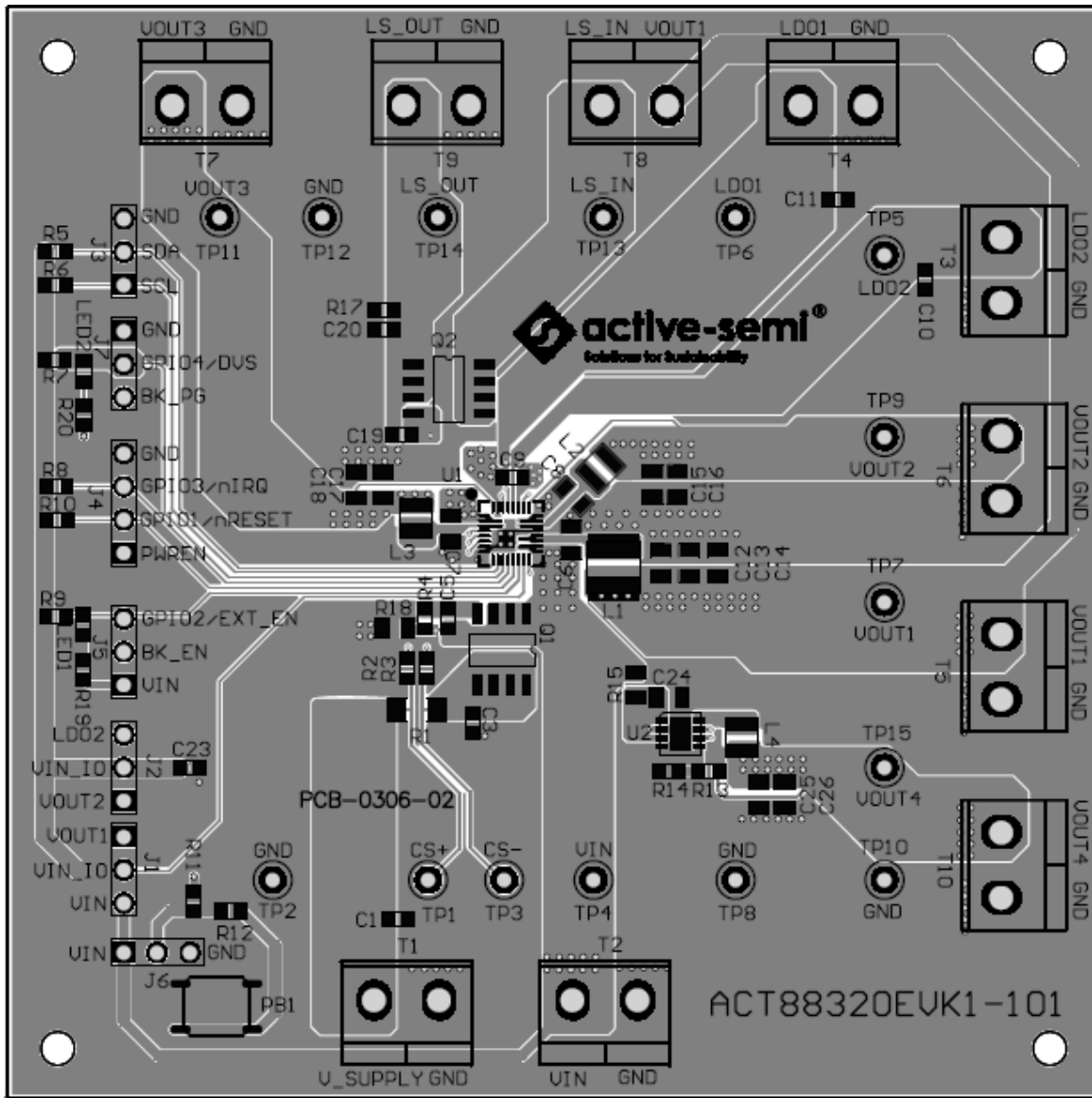

Figure 6 – Layout Top Assembly

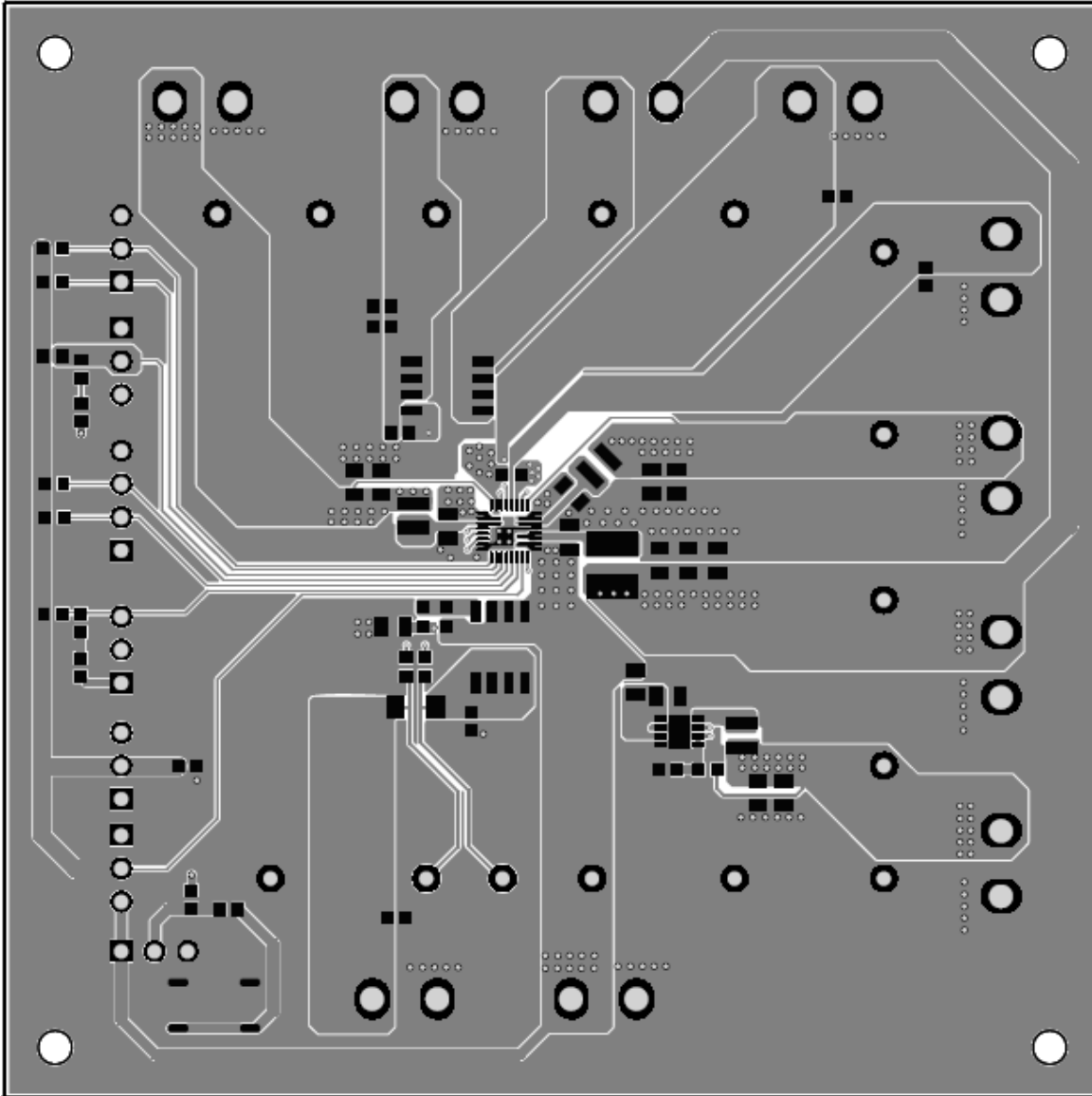

Figure 7 – Layout Top Layer

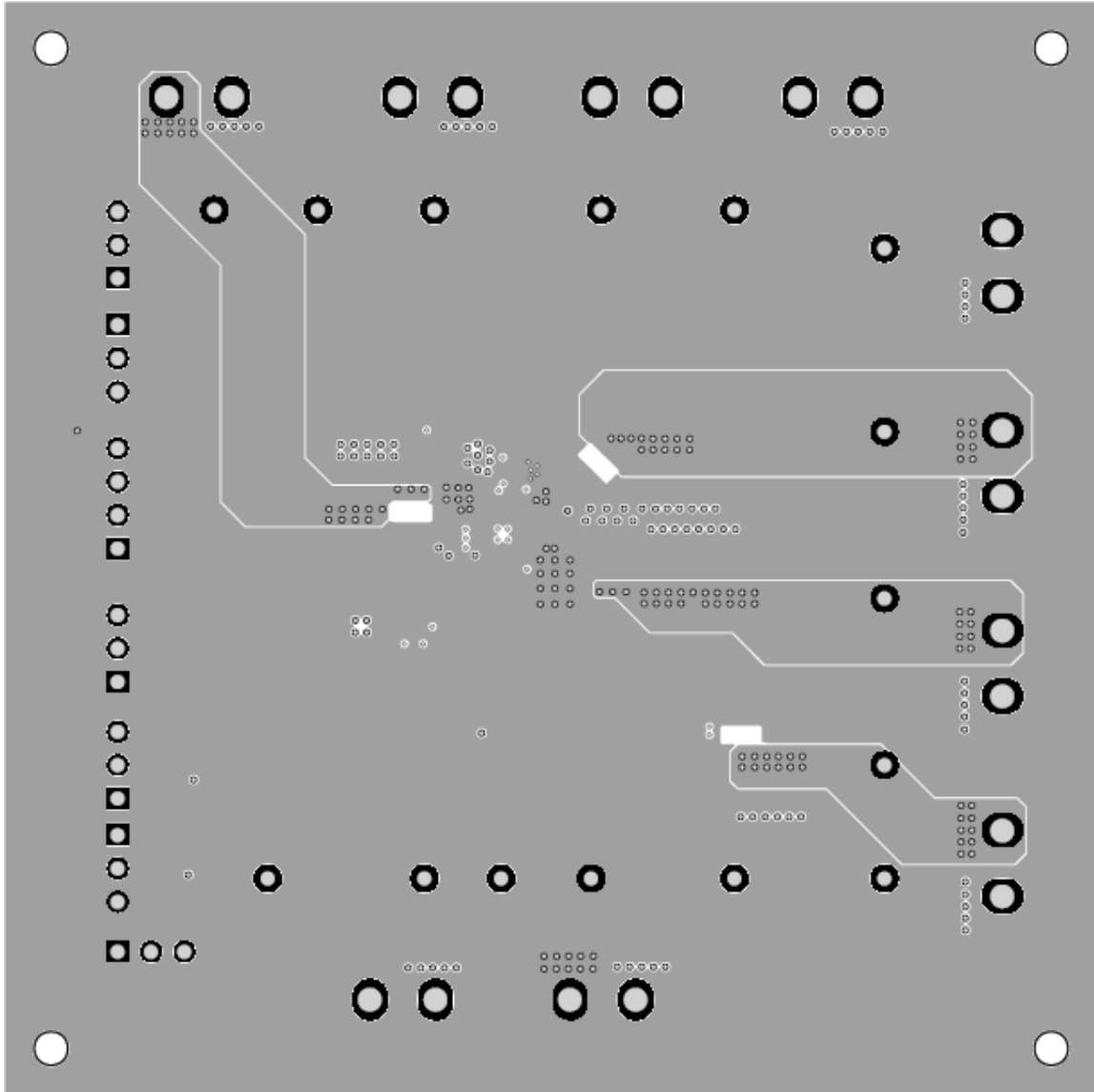

Figure 8 – Layout Layer 2

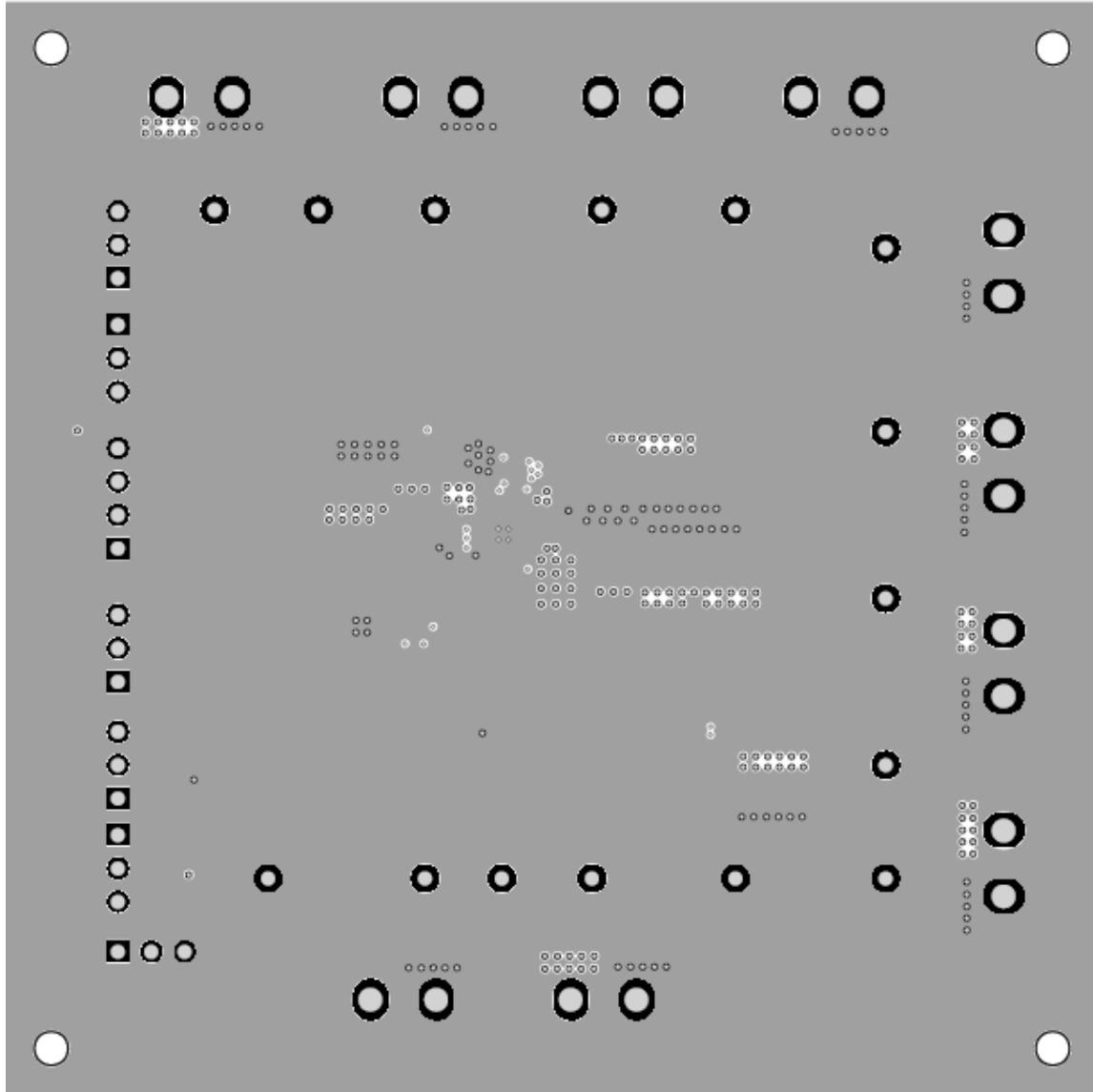

Figure 9 – Layout Layer 3

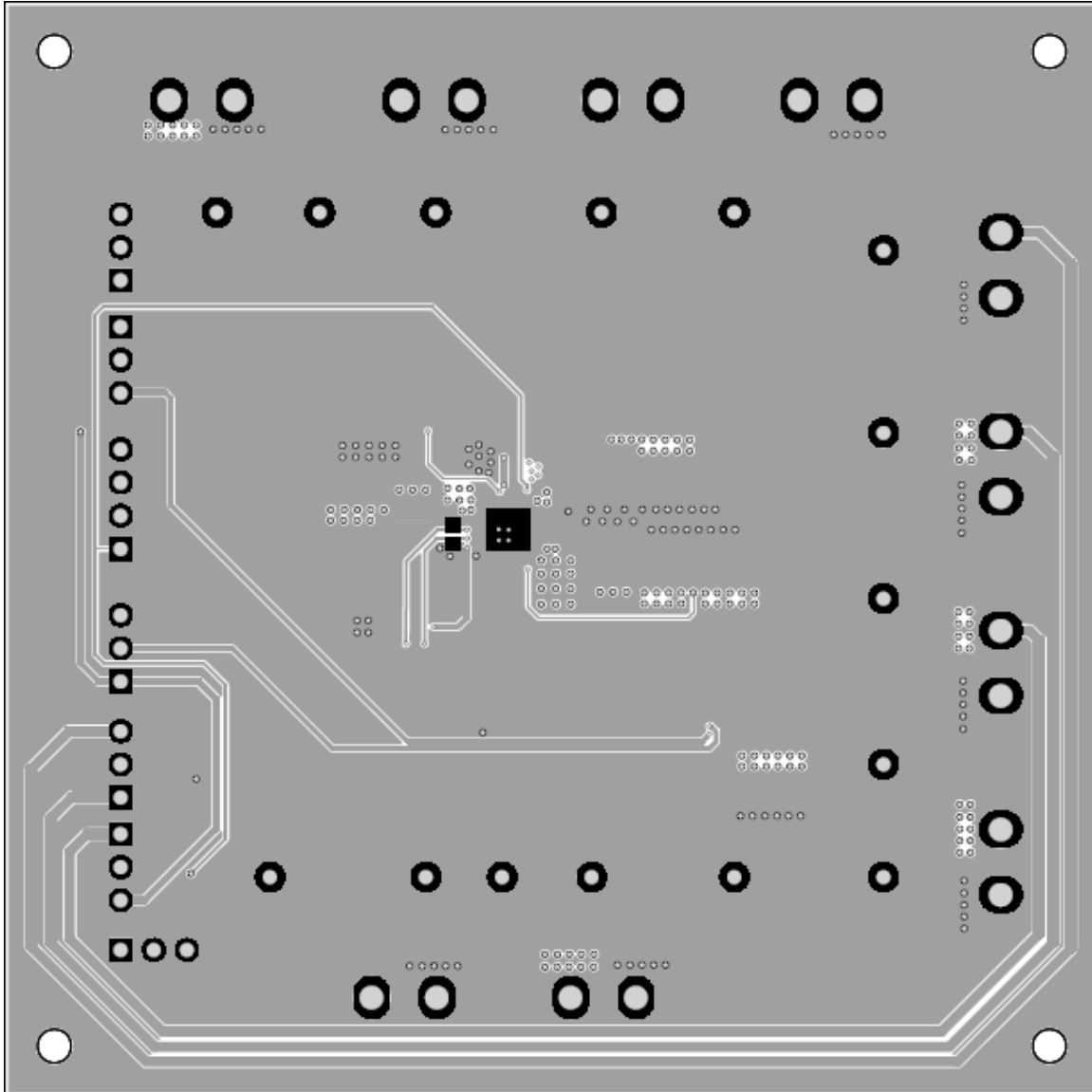

Figure 10 – Layout Bottom Layer

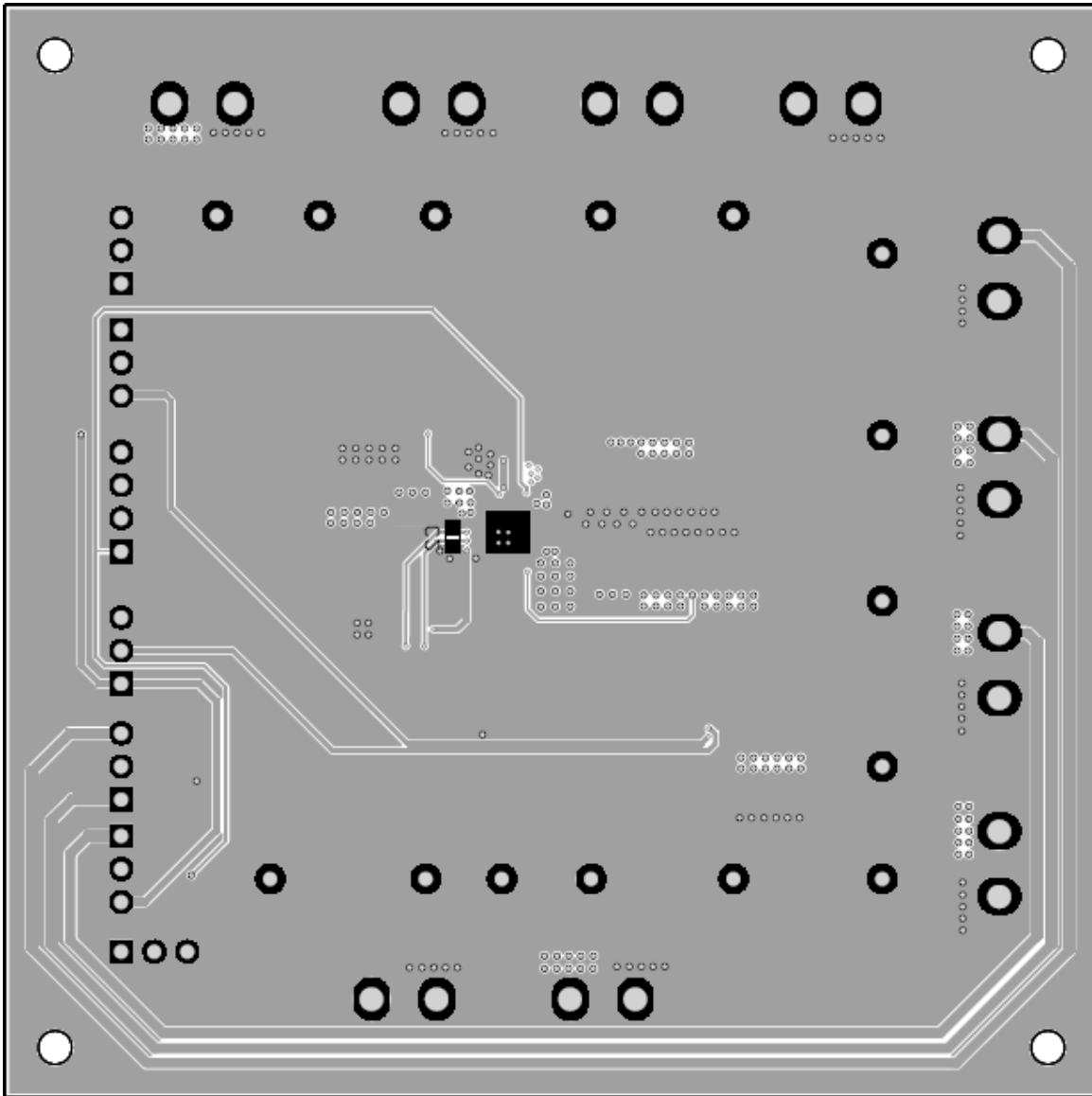

Figure 11 – Layout Bottom Assembly

Bill of Materials
Table 2 - BOM

Item	Ref Des	QTY	Description	Package	MFR	Part Number
1	C1	1	Cap, Ceramic, 4.7uF, 6.3V, 20%, X5R	0603	Yageo	std
2	C2, C5	2	Cap, Ceramic, 1nF, 6.3V, 20%, X5R	0603	Yageo	std
3	C3, C9, C10, C11, C20, C23	6	Cap, Ceramic, 1uF, 10V, 20%, X5R	0603	Yageo	std
4	C6, C7, C8, C12, C13, C15, C17, C25, C26	9	Cap, Ceramic, 22uF, 10V, 10%, X7R	0805	Yageo	std
5	C14, C16, C18	0	Cap, Ceramic, 22uF, 10V, 10%, X7R	0805	Yageo	std
6	C19	1	Cap, Ceramic, 2.2nF, 10V, 20%, X5R	0603	Yageo	std
7	C24	1	Cap, Ceramic, 10uF, 10V, 20%, X5R	0805	Yageo	std
8	J1, J2, J3, J5, J6, J7	6	Header, 3 pin, 100mil	CON3	Würth Elektronik	61300311121
9	J4	1	Header, 4 pin, 100mil	CON4	Würth Elektronik	61300411121
10	L1	1	Inductor, 1uH, 7.2A, 12mohm	Würth 4020	Würth Elektronik	74438356010
11	L2, L3, L4	3	Inductor, 1uH, 2.5A, 63mohm	Würth 2510	Würth Elektronik	74438323010
12	LED1, LED2	2	LED, Blue	0603	Würth Elektronik	150060BS75000
13	PB1	1	Push button	4x4x1.5mm	N/A	std
14	Q1, Q2	2	N-MOSFET, 30V/12A	SOIC-8	AOS	AO4566
15	R1	1	Res, 10mΩ, 0.5%	1206	SART	std
16	R2, R3, R4, R11	4	Res, 1kΩ, 1%	0603	Yageo	std
17	R5, R6, R7, R8, R9, R10	6	Res, 10kΩ, 1%	0603	Yageo	std
18	R12	1	Res, 51kΩ, 1%	0603	Yageo	std
19	R13	1	Res, 174kΩ, 1%	0603	Yageo	std
20	R14	1	Res, 200kΩ, 1%	0603	Yageo	std
21	R15	1	Res, 0Ω, 1%	0805	Yageo	std
22	R17	1	Res, 100kΩ, 1%	0603	Yageo	std
23	R18	0	Res, 1kΩ, 1%	0805	Yageo	std
24	R19, R20	2	Res, 2.2kΩ, 1%	0603	Yageo	std
25	T1, T2, T3, T4, T5, T6, T7, T8, T9, T10	10	Entry modular, 2 Pins .5mm		Würth Elektronik	691213710002
26	TP1, TP4, TP5, TP6, TP7, TP9, TP11, TP13, TP14, TP15	10	Test Point, Red	0.063"	Keystone	5000
27	TP2, TP3, TP8, TP10, TP12	5	Test Point, Black	0.063"	Keystone	5001
28	U1	1	IC, ACT88320, PMU with inrush protection	QFN4X4-32	Active-semi	ACT88320QI101-T
29	U2	1	IC, ACT8311, Buck converter	TDFN33-8	Active-semi	ACT8311NHADJ-T

GUI Installation

1. Contact Active Semi for the GUI files and save them on your computer.
2. Plug the USB-TO-I2C dongle into a free USB port.
3. Follow the instructions in the “How to install driver for dongle” folder.

	Driver	Nguyen Thi	Mar 30, 2017	Nguyen Thi	–
	How to install driver for dongle	Nguyen Thi	Mar 30, 2017	Nguyen Thi	–
	ACT88320 GUI Rev0.1.cpmu 	Nguyen Thi	Mar 30, 2017	Nguyen Thi	84 KB
	ACT88320 GUI Rev0.1.exe 	Nguyen Thi	Aug 9, 2016	Nguyen Thi	3 MB
	ACT88320 GUI User Guide Rev0.1.pdf 	Nguyen Thi	Mar 30, 2017	Nguyen Thi	331 KB

Figure 12 – Dongle Driver

4. Double click on the ACT88320 GUI.exe to start the ACT88320 GUI.

GUI Overview

The GUI has 2 basic function buttons allocated in top-left of the Tool Bar which are Read and Write I2C. The GUI contains 2 setting modes: Basic Mode and Advanced Mode. In Basic Mode screen it displays basic user programmable configuration options are programmed using the drop-down boxes or check boxes. Advanced Mode contain the button text for changing setting for every single bit.

Basic Mode

The following figure show the GUI in basic mode. This mode allows the user to easily change one or more IC settings.

Figure 13 – GUI Basic Mode

Advanced Mode

Click the “Advanced Mode” button in the left of the GUI screen to see all available user programmable options. With Advanced Mode, additional user programmable features can be selected using the button text. In the left side of the Advanced Mode Screen, click on the Tiles Selector to display the register to view or change. Then change a register one bit at a time by clicking on the desired bit. The value of the bit is display right next to the bit-name button.

Note that the far right side of the screen contains a scroll down button to scroll down to additional registers since the Tile Screen can only display up to 8 bytes at once.

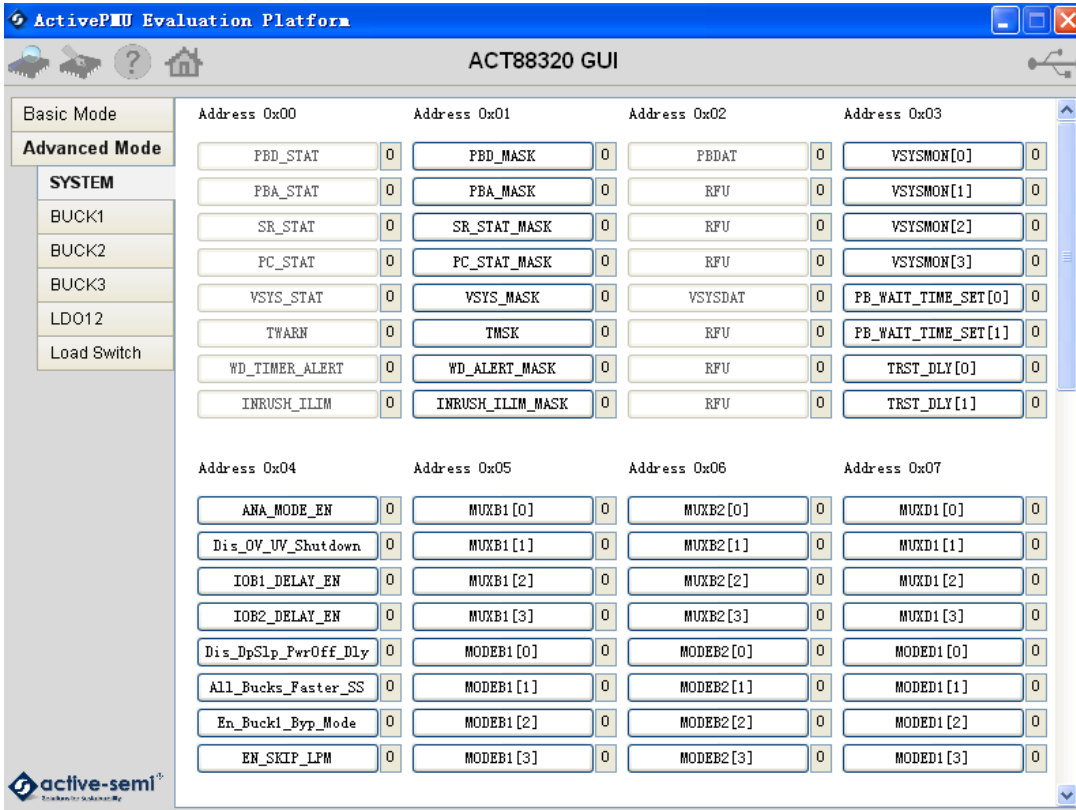

Figure 14 – GUI Advanced Mode

Button Descriptions

Read: Clicking on this button reads the ACT88320 registers and displays them in the GUI. Note that this reads all registers. Active-Semi recommends reading registers each time the ACT88320 powers-up to acquire the initial register settings. Active-semi also recommends reading registers after making changes to them. Immediately reading the registers after a write confirms the changes were properly stored.

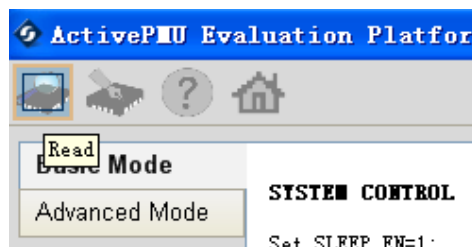

Figure 15 – Read Button

Write: Clicking on this button writes the GUI settings to the ACT88320's registers. All registers are written, regardless of whether or not they were changed.

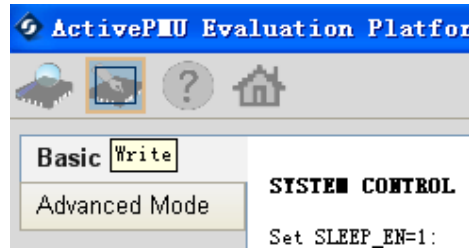

Figure 16 – Write Button

Dongle Connection Status: The GUI also contains a dongle is connected status which indicates that Active-Semi's USB-TO-I2C dongle is connected to the USB port of the driver installed. The figure below shows the two possible indication status graphics.



Figure 17 – Dongle Connection Status