



Electret Condenser Microphone Cartridge Preamp

MAX9810

General Description

The MAX9810 microphone preamplifier is intended for use inside electret condenser microphone (ECM) cartridges. Current solutions use a FET as an impedance converter. FETs have limited gain, are susceptible to noise and require additional components external to the ECM cartridge for biasing and amplification. The MAX9810 replaces the FET with a high-gain, high-noise rejection, low-output-impedance amplifier. Designed to be integrated inside the ECM cartridge, the MAX9810 offers a flat frequency response, tightly controlled gain, increased sensitivity, and high-noise rejection greatly simplifying system design. Target applications include ECM cartridges in cell phones, PDAs, notebooks, and other portable audio devices.

The MAX9810 operates from a single 2.3V to 5.5V supply and consumes only 670 μ A of quiescent current. The device features an internally generated 1.5V DC bias, and is available in three internally fixed gain options (24dB, 27dB, and 30dB). The MAX9810 is specified over the extended temperature range (-40°C to +85°C) and comes in a tiny 4-bump chip-scale package (UCSP™) that is designed to fit inside the ECM cartridge.

Applications

Electret Condenser Microphone Cartridges In:

- Cell Phones
- Notebooks
- PDAs
- Portable Audio

Functional Diagram/ Typical Application Circuit

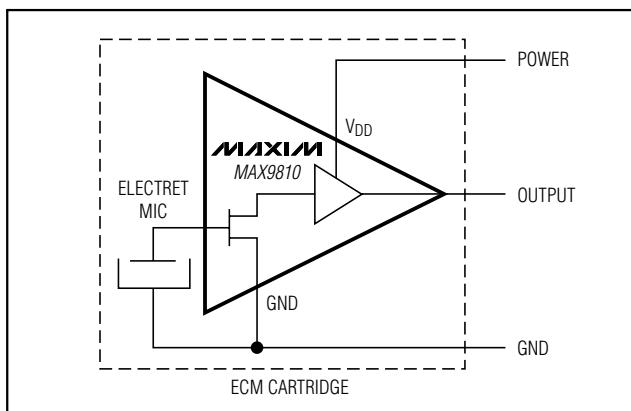

Rail-to-Rail is a registered trademark of Nippon Motorola Ltd.

USCP is a trademark of Maxim Integrated Products, Inc.

MAXIM

Maxim Integrated Products 1

For pricing, delivery, and ordering information, please contact Maxim/Dallas Direct! at 1-888-629-4642, or visit Maxim's website at www.maxim-ic.com.

Features

- ◆ Replaces FET in Electret Condenser Microphone
- ◆ 2.3V to 5.5V Single-Supply Operation
- ◆ Low-Impedance Output (<0.4 Ω)
- ◆ High PSRR: 82dB
- ◆ Three High-Gain Options:
 - MAX9810A: 24dB
 - MAX9810B: 27dB
 - MAX9810C: 30dB
- ◆ Internal Bias Voltage
- ◆ Low Supply Current (670 μ A)
- ◆ Rail-to-Rail® Output
- ◆ No Output Phase Reversal During Overload Conditions
- ◆ Available in a Tiny 4-Bump UCSP

Ordering Information

PART	TEMP RANGE	BUMP-PACKAGE	TOP MARK
MAX9810AEBS-T	-40°C to +85°C	4 UCSP-4	AFS
MAX9810BEBS-T	-40°C to +85°C	4 UCSP-4	AFT
MAX9810CEBS-T	-40°C to +85°C	4 UCSP-4	AFU

Selector Guide

PART	BUMP-PACKAGE	GAIN (dB)
MAX9810AEBS-T	4 UCSP-4	24
MAX9810BEBS-T	4 UCSP-4	27
MAX9810CEBS-T	4 UCSP-4	30

Pin Configuration

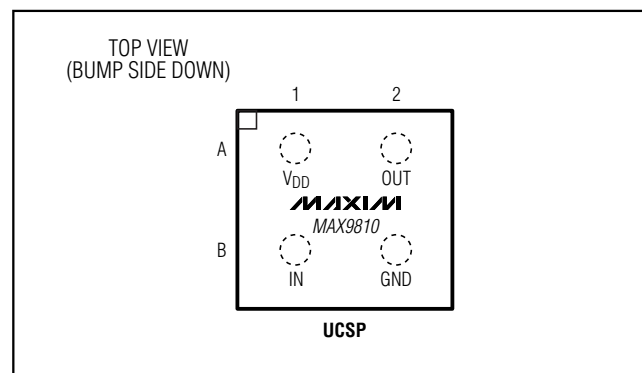

Electret Condenser Microphone Cartridge Preamplifier

ABSOLUTE MAXIMUM RATINGS

V _{DD} to GND	-0.3V to +6V	Operating Temperature Range	-40°C to +85°C
All Other Pins to GND.....	-0.3V to (V _{DD} + 0.3V)	Junction Temperature	+150°C
Continuous Current (IN, OUT)	±20mA	Storage Temperature Range	-65°C to +150°C
Output Short-Circuit Duration (to GND or V _{DD}).....	Continuous	Bump Temperature (soldering) (Note 1)	
Continuous Power Dissipation (T _A = +70°C)		Infrared (15s)	+220°C
4-Bump UCSP (derate 3.0mW/°C above +70°C)	238.8mW	Vapor Phase (60s)	+215°C

Note 1: This device is constructed using a unique set of packaging techniques that impose a limit on the thermal profile the device can be exposed to during board level solder attach and rework. This limit permits only the use of the solder profiles recommended in the industry standard specification, JEDEC 020A, paragraph 7.6, Table 3 for IR/VPR and convection reflow. Preheating is required. Hand or wave soldering is not allowed.

Stresses beyond those listed under "Absolute Maximum Ratings" may cause permanent damage to the device. These are stress ratings only, and functional operation of the device at these or any other conditions beyond those indicated in the operational sections of the specifications is not implied. Exposure to absolute maximum rating conditions for extended periods may affect device reliability.

DC ELECTRICAL CHARACTERISTICS

(V_{DD} = 3V, GND = 0, R_L = ∞, V_{IN} = 0, T_A = T_{MIN} to T_{MAX}, unless otherwise noted. Typical values are at T_A = +25°C.) (Note 2)

PARAMETER	SYMBOL	CONDITIONS	MIN	TYP	MAX	UNITS	
Supply Voltage Range	V _{DD}	Inferred from PSRR test	2.3		5.5	V	
Quiescent Supply Current	I _{DD}	2.3V ≤ V _{DD} ≤ 5.5V		670	950	μA	
Output Bias Voltage	V _{BIAS}	MAX9810A	1.3	1.48	1.7	V	
		MAX9810B	1.3	1.53	1.7		
		MAX9810C	1.3	1.58	1.8		
Input Bias Current	I _{BIAS}	(Note 3)		5	100	pA	
Input Resistance	R _{IN}		0.025	5		GΩ	
Power-Supply Rejection Ratio	PSRR	2.3V < V _{DD} < 5.5V (Note 4)	70	86		dB	
Output Voltage Swing High	V _{OH}	R _L = 10kΩ connected to 1.5V	V _{DD} - 0.04	V _{DD} - 0.015		V	
		R _L = 1kΩ connected to 1.5V	V _{DD} - 0.15	V _{DD} - 0.07			
Output Voltage Swing Low	V _{OL}	R _L = 10kΩ connected to 1.5V		0.005	0.015	V	
		R _L = 1kΩ connected to 1.5V		0.045	0.08		
Output Short-Circuit Current	I _{SCC}	V _{DD} = 5V		12		mA	
		V _{DD} = 2.3V		10			
Voltage Gain	A _V	V _{IN} = ±20mV	MAX9810A	23	24	25	dB
			MAX9810B	26	27	28	
			MAX9810C	29	30	31	

Electret Condenser Microphone Cartridge Preamplifier

MAX9810

AC ELECTRICAL CHARACTERISTICS

($V_{DD} = 3V$, $GND = 0$, $R_L = 10k\Omega$ connected to $1.5V$, $C_L = 20pF$, $C_{IN} = 30pF$ connected to GND , $V_{IN} = 0$, $T_A = T_{MIN}$ to T_{MAX} , unless otherwise noted. Typical values are at $T_A = +25^\circ C$.)

PARAMETER	SYMBOL	CONDITIONS		MIN	TYP	MAX	UNITS
Small-Signal -3dB Bandwidth	BW _{SS}	$V_{OUT} = 10mV_{P-P}$			900		kHz
Slew Rate	SR	$V_{OUT} = 1V$ step			0.03		V/ μs
Settling Time to 0.1%	t_s	$V_{OUT} = 1V$ step			1		μs
Input-Noise Voltage Density	e_n	$R_S = 0$ (Note 5)	10Hz		60		nV/ \sqrt{Hz}
			1kHz		16		
			10kHz		15		
Input-Noise Current Density	i_n	10Hz			5		pA/ \sqrt{Hz}
		1kHz			1		
		10kHz			1		
Total Integrated Noise		Noise bandwidth = 20Hz to 7kHz			4		μV_{RMS}
Signal-to-Noise Ratio	SNR	$V_{OUT} = 2V_{P-P}$, noise bandwidth = 20Hz to 7kHz			90		dB
Output Impedance	Z_{OUT}	$f_{IN} = 1kHz$			0.4		Ω
Power-Supply Rejection Ratio	PSRR	$V_{DD} = 3V$, $V_{RIPPLE} = 100mV$, $f_{RIPPLE} = 1kHz$			82		dB
RF Noise Immunity		1GHz—carrier, 1kHz—AM tone			82		dB
Total Harmonic Distortion Plus Noise	THD + N	$f_{IN} = 1kHz$, $V_{OUT} = 1V_{P-P}$, noise bandwidth = 22Hz to 22kHz			0.02		%
Input Capacitance	C_{IN}				3		pF
Turn-On Time	t_{ON}				10		μs

Note 2: All specifications are 100% tested at $T_A = +25^\circ C$, temperature limits are guaranteed by design.

Note 3: Guaranteed by design. Not production tested.

Note 4: PSRR is input-referred.

Note 5: Noise measurement includes the noise contribution of the internal gain-setting resistors.

Electret Condenser Microphone Cartridge Preamplifier

Typical Operating Characteristics

($V_{DD} = 3V$, $GND = 0$, $R_L = 10k\Omega$ connected to $1.5V$, $C_L = 20pF$, $C_{IN} = 30pF$ connected to GND , $V_{IN} = 0$, $T_A = +25^\circ C$, unless otherwise noted.)

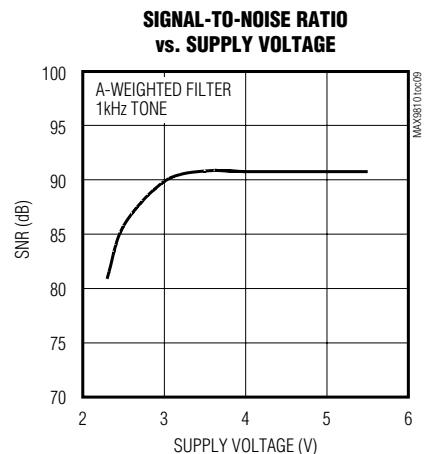
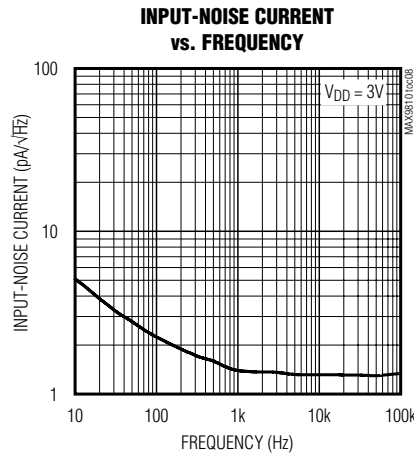
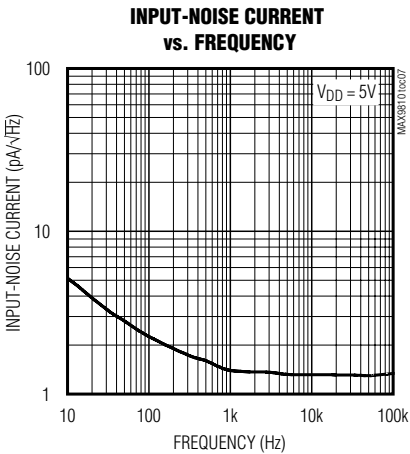
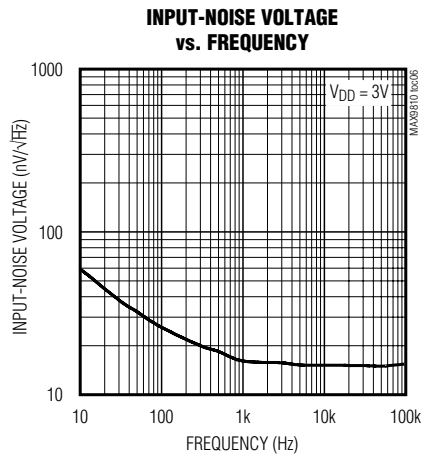
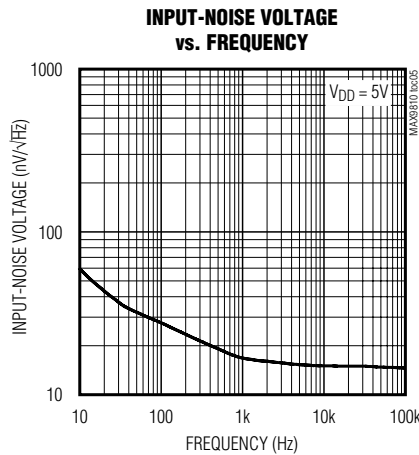
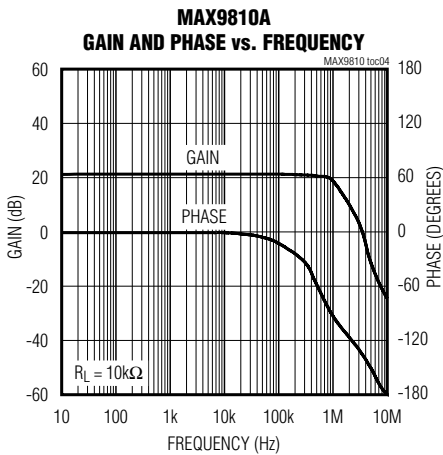
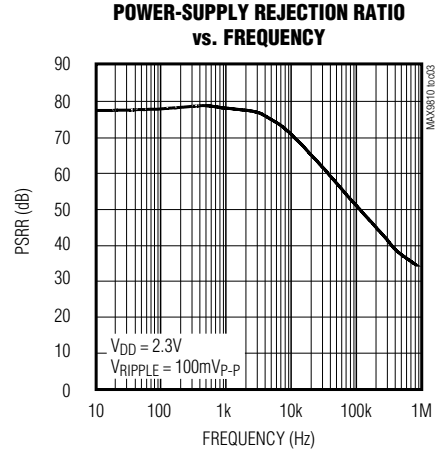
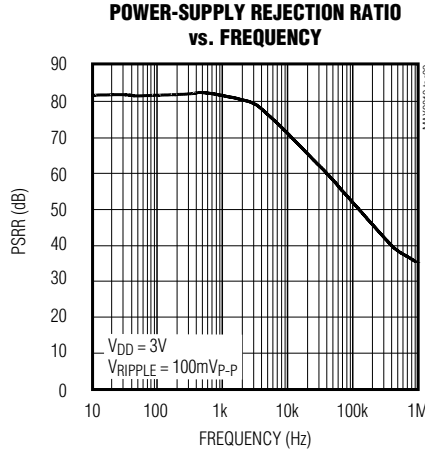
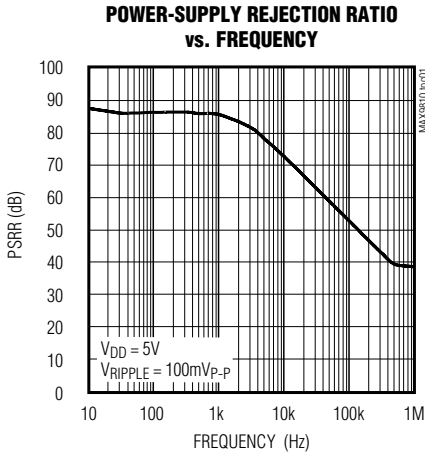

Electret Condenser Microphone Cartridge Preamp

Typical Operating Characteristics (continued)

($V_{DD} = 3V$, $GND = 0$, $R_L = 10k\Omega$ connected to 1.5V, $C_L = 20pF$, $C_{IN} = 30pF$ connected to GND , $V_{IN} = 0$, $T_A = +25^\circ C$, unless otherwise noted.)

MAX9810

1kHz REJECTION vs. SWEEPED AC SIGNAL ON POWER SUPPLY

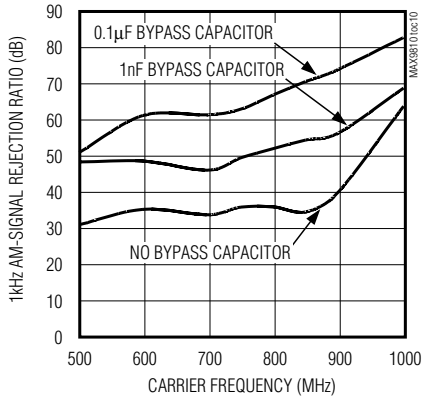

OUTPUT VOLTAGE HIGH vs. LOAD

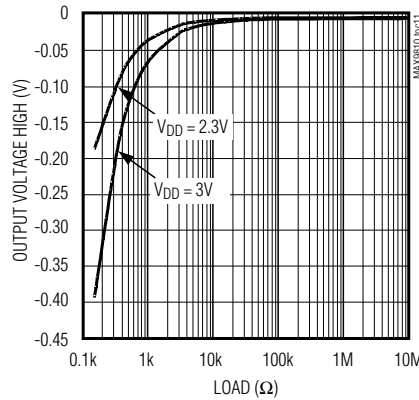

OUTPUT VOLTAGE LOW vs. LOAD

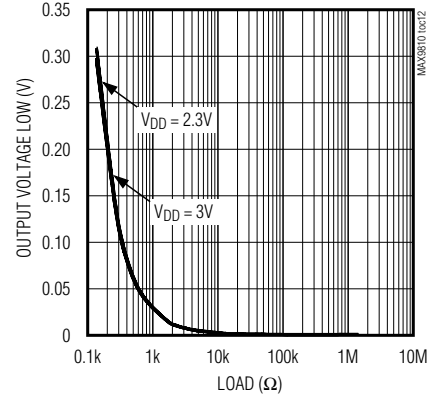

OUTPUT IMPEDANCE vs. FREQUENCY

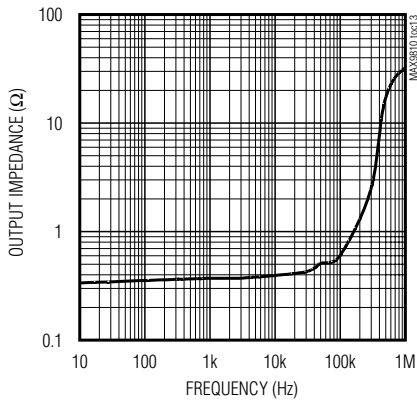

TOTAL HARMONIC DISTORTION PLUS NOISE vs. FREQUENCY

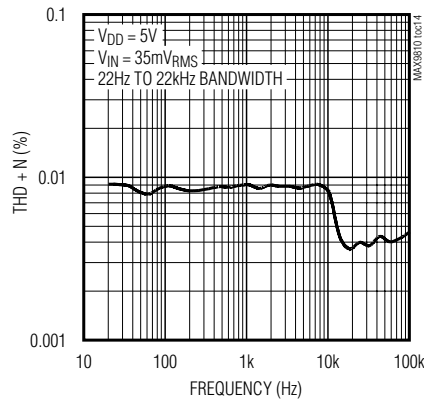

TOTAL HARMONIC DISTORTION PLUS NOISE vs. FREQUENCY

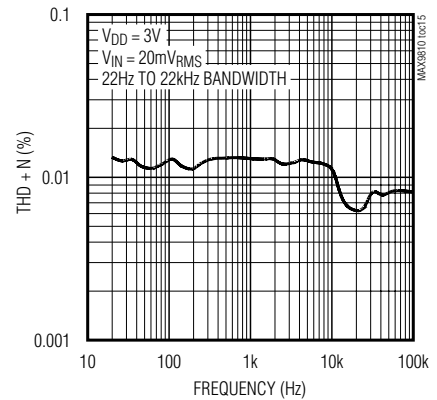

TOTAL HARMONIC DISTORTION PLUS NOISE vs. OUTPUT VOLTAGE

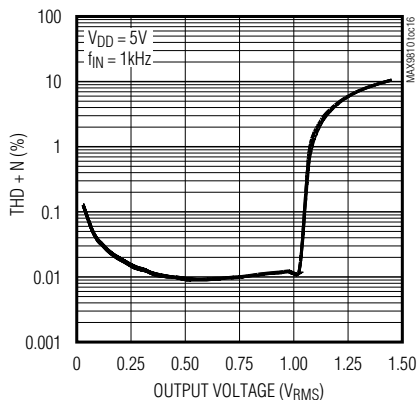

TOTAL HARMONIC DISTORTION PLUS NOISE vs. OUTPUT VOLTAGE

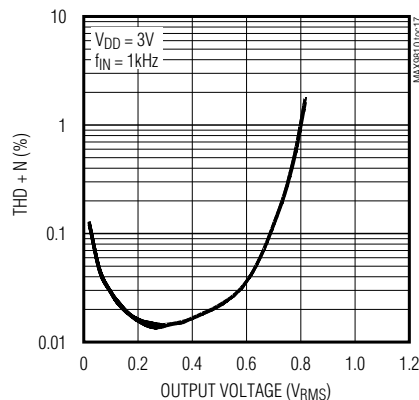

TOTAL HARMONIC DISTORTION PLUS NOISE vs. OUTPUT VOLTAGE

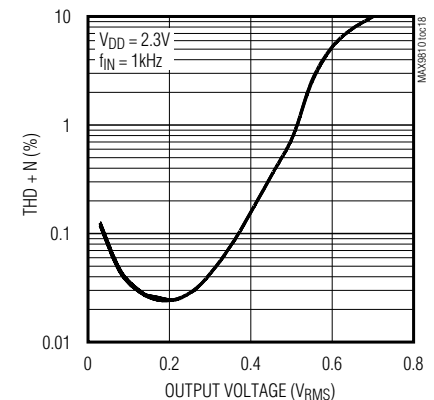

Electret Condenser Microphone Cartridge Preamp

Typical Operating Characteristics (continued)

($V_{DD} = 3V$, $GND = 0$, $R_L = 10k\Omega$ connected to $1.5V$, $C_L = 20pF$, $C_{IN} = 30pF$ connected to GND , $V_{IN} = 0$, $T_A = +25^\circ C$, unless otherwise noted.)

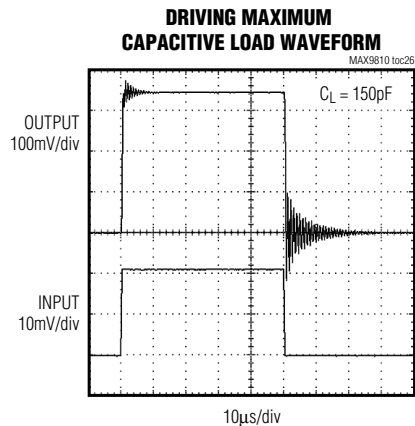
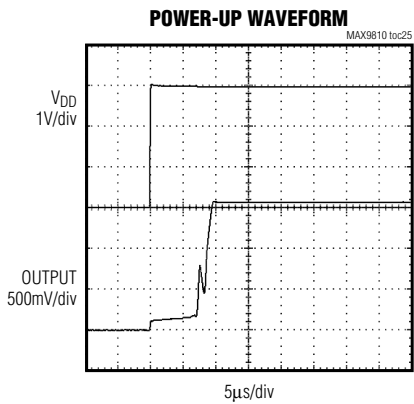
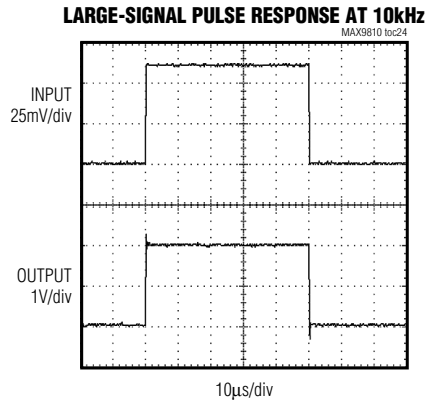
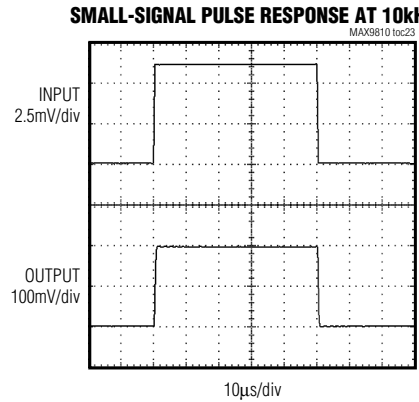
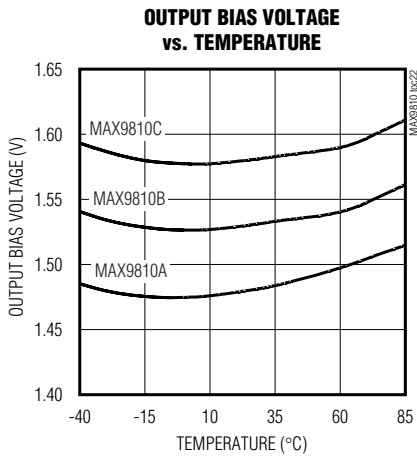
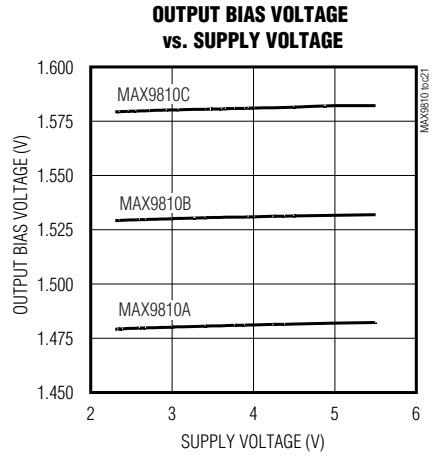
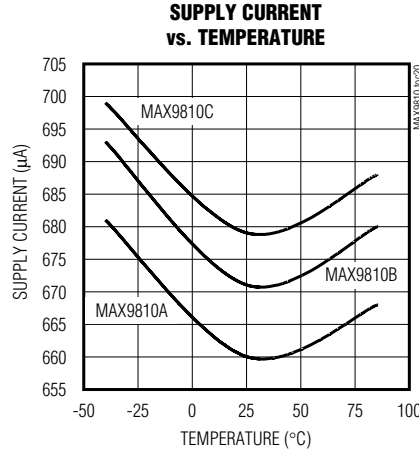
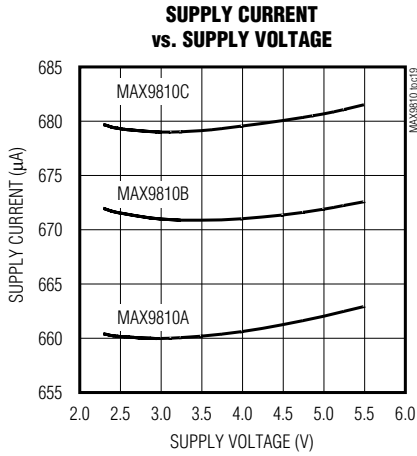

Electret Condenser Microphone Cartridge Preamplifier

Pin Description

BUMP	NAME	DESCRIPTION
A1	V _{DD}	Amplifier Power Supply
A2	OUT	Amplifier Output
B1	IN	Amplifier Input
B2	GND	Ground

Detailed Description

The MAX9810 replaces the FET commonly used in ECMs with a high-gain, low-noise, low-output-impedance amplifier, offering improved performance over the traditional FET solution. The MAX9810 features high PSRR (82dB at 1kHz), and is available in three gain options (24dB, 27dB, and 30dB). ECMs with FET impedance converters require additional amplification (Figure 1). The high gain of the MAX9810 eliminates the need for an external preamplifier, allowing the ECM cartridge to be directly connected to front-end devices such as CODECs or ADCs (Figure 2). The MAX9810 also features excellent RF immunity (see the *RF Noise Rejection* section).

Rail-to-Rail Output

When operated from a 3V supply, the internal 1.5V DC bias point provides symmetrical, rail-to-rail operation where the output can swing to within 15mV of either rail into a 10kΩ load. The 1.5V bias point is independent of supply, so when operated from supplies other than 3V, the MAX9810 output can run out of headroom on one of the supplies (Figure 3). This limits the peak-to-peak output to approximately:

$$V_{OUT(P-P)} = 3V \text{ for } V_{DD} > 3V$$

$$V_{OUT(P-P)} = V_{DD} \text{ for } V_{DD} < 3V$$

The MAX9810 shows no phase reversal when the device is overdriven. If the device output is driven into clipping, the overload behavior is predictable.

Applications Information

RF Noise Rejection

The MAX9810 features excellent RF rejection at common cellular-phone operating frequencies. Figure 4 shows the modulation products of a high-frequency signal coupling into the device power supply, while the device is driven with a 1kHz input. At 1GHz, the MAX9810 exhibits 82dB of rejection.

Supply Bypassing

Unlike FETs, the MAX9810 requires a separate power source (Figures 1 and 2). V_{DD} must be connected to a 2.3V to 5.5V power supply external to the ECM cartridge, thus the MAX9810 ECM solution requires three electrical connections instead of the two commonly found in current FET solutions.

For optimum performance, bypass the MAX9810 as close to the device as possible (inside the cartridge). This yields the best RF rejection and PSRR and is ideal for applications such as cell phones where high-frequency noise is present. The device operates properly if the bypass capacitor is placed on the circuit board outside the cartridge; however, RF rejection is slightly degraded in this configuration (Figure 4). This is well suited for applications where there is less high-frequency interference such as PDAs and notebook computers.

UCSP Layout

For land pattern and suggested layout of the 4-bump UCSP, see the JEDEC website at www.ipc.org/html/framesetcatseg.html.

Electret Condenser Microphone Cartridge Preamplifier

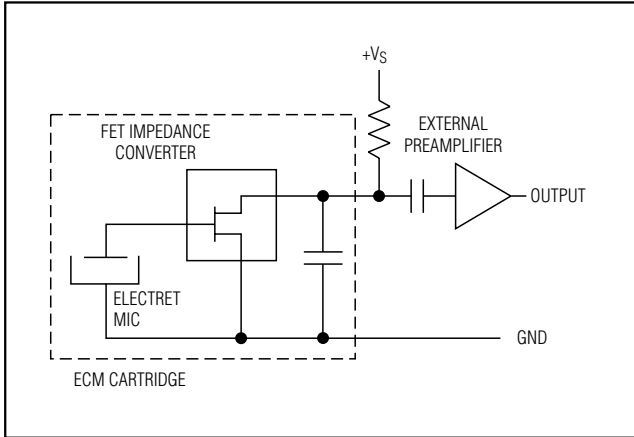

Figure 1. Conventional FET ECM

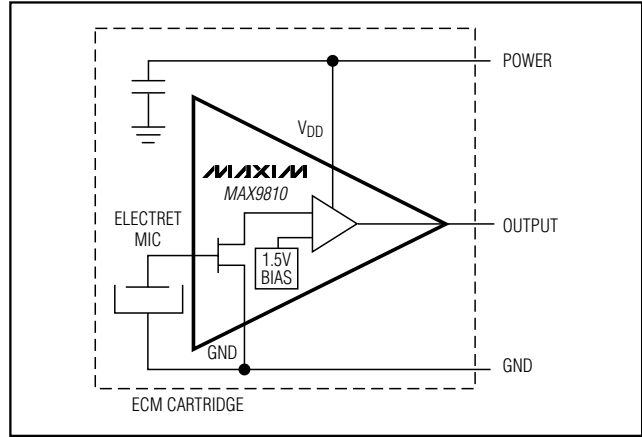

Figure 2. MAX9810 ECM

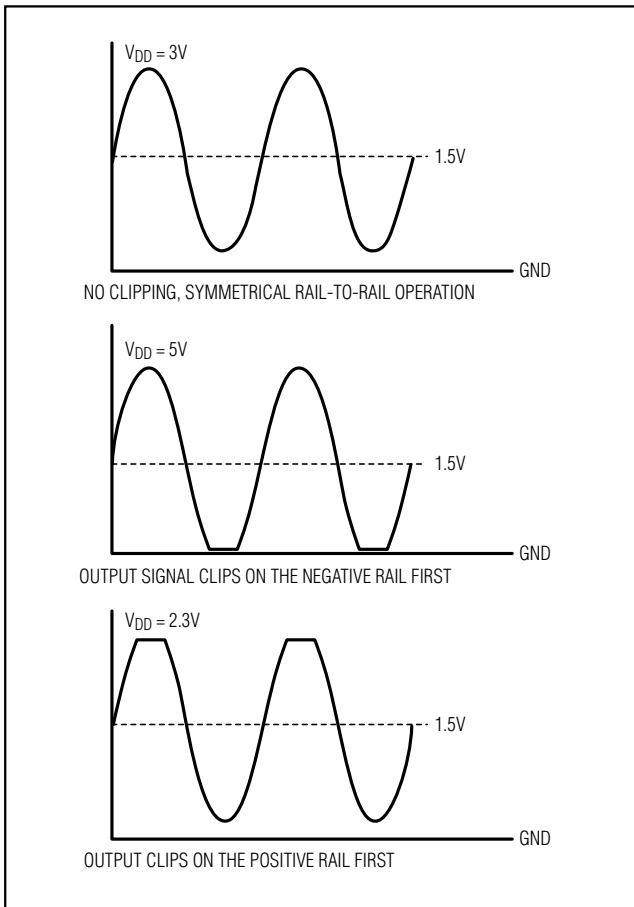

Figure 3. Rail-to-Rail Waveforms

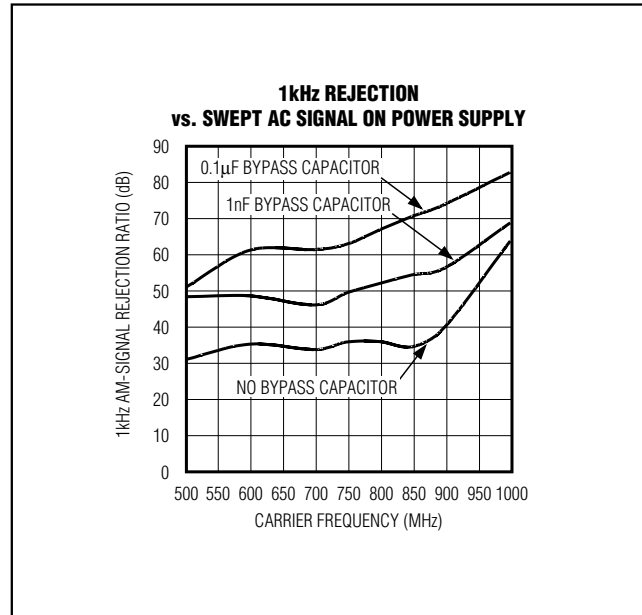

Figure 4. MAX9810 RF Rejection

Chip Information

TRANSISTOR COUNT: 427
 PROCESS: BiCMOS

Electret Condenser Microphone Cartridge Pre-amplifier

Package Information

(The package drawing(s) in this data sheet may not reflect the most current specifications. For the latest package outline information, go to www.maxim-ic.com/packages.)

MAX9810

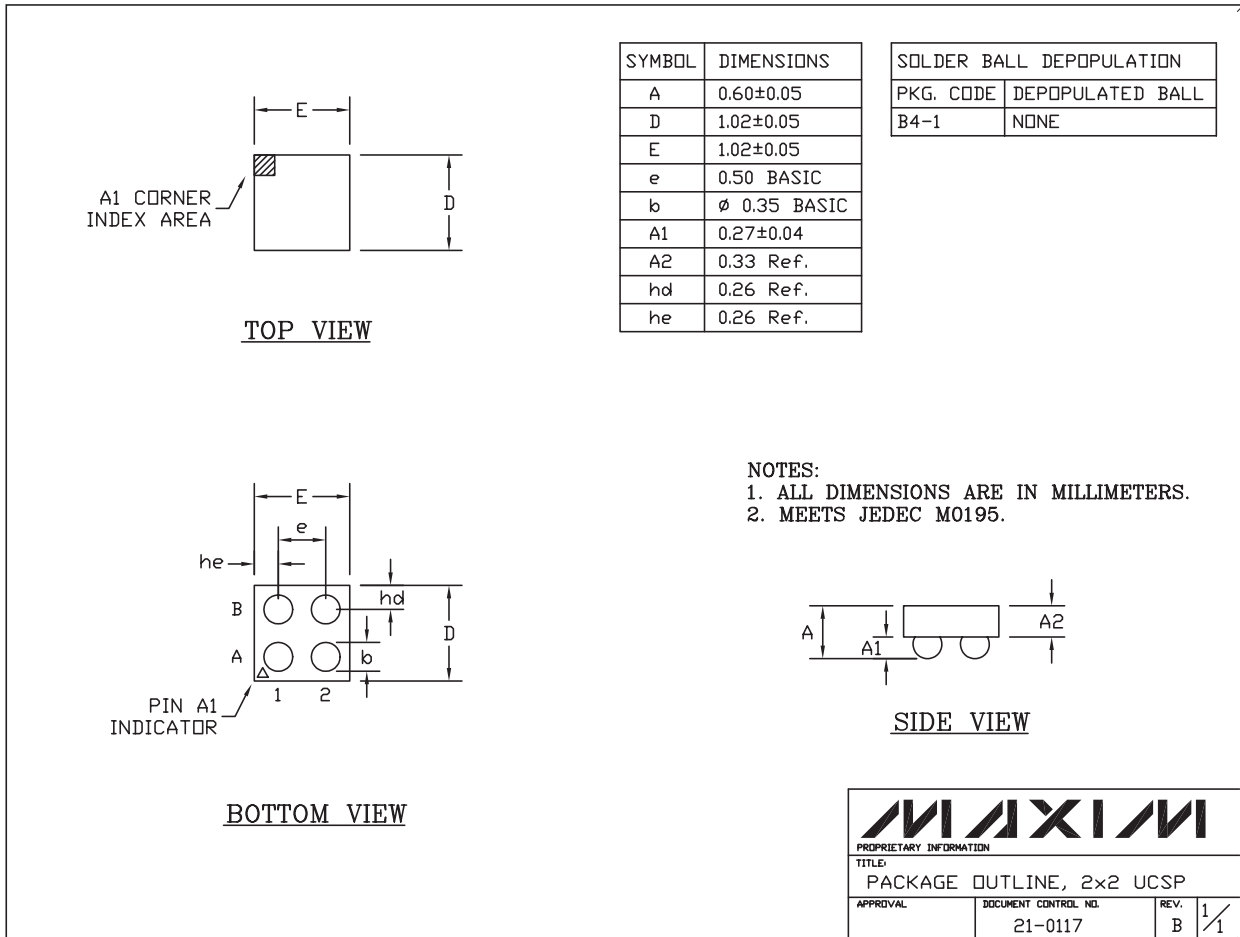

Maxim cannot assume responsibility for use of any circuitry other than circuitry entirely embodied in a Maxim product. No circuit patent licenses are implied. Maxim reserves the right to change the circuitry and specifications without notice at any time.

Maxim Integrated Products, 120 San Gabriel Drive, Sunnyvale, CA 94086 408-737-7600 _____ 9