

## CHIP COIL (CHIP INDUCTORS) LQW18AN□□□□80D Reference Specification

### 1.Scope

This Reference specification applies to LQW18AN\_80D series, Chip coil (Chip Inductors).

### 2.Part Numbering

(ex)   LQ     W     18     A     N     2N2     C     8     0     D    
 Product ID Structure Dimension Applications Category Inductance Tolerance Features Electrode Packaging  
 (L × W) and Characteristics D:Taping \*B:Bulk

\*Bulk packing also available. (A product is put in the plastic bag under the taping conditions.)

### 3.Rating

- Operating Temperature Range.      −55°C to +125°C
- Storage Temperature Range.       −55°C to +125°C

Customer Part Number	MURATA Part Number	Inductance		Q (min.)	DC Resistance (Ω max.)	Self Resonant Frequency (MHz min.)	Rated Current (mA)
		(nH)	Tolerance				
	LQW18AN2N2C80D	2.2	C:±0.2nH	24	0.018	15000	3200
	LQW18AN2N4C80D	2.4		18	0.026		2400
	LQW18AN3N0C80D	3.0		13	0.17		670
	LQW18AN3N9B80D	3.9	B:±0.1nH C:±0.2nH G:±2%	30	0.028	10000	2200
	LQW18AN3N9C80D						
	LQW18AN3N9G80D						
	LQW18AN4N1B80D						
	LQW18AN4N1C80D						
	LQW18AN4N1G80D						
	LQW18AN4N2B80D	4.2					
	LQW18AN4N2C80D						
	LQW18AN4N2G80D						
	LQW18AN4N3B80D	4.3					
	LQW18AN4N3C80D						
	LQW18AN4N3G80D						
	LQW18AN4N7B80D	4.7					
	LQW18AN4N7C80D						
	LQW18AN4N7G80D						
	LQW18AN4N9B80D	4.9					
	LQW18AN4N9C80D						
	LQW18AN4N9G80D						
	LQW18AN5N6C80D	5.6	C:±0.2nH G:±2%	38	0.040	6650	1900
	LQW18AN5N6G80D						
	LQW18AN6N0C80D						
	LQW18AN6N0G80D	6					
	LQW18AN6N5C80D						
	LQW18AN6N5G80D						
	LQW18AN6N8C80D	6.8					
	LQW18AN6N8G80D						
	LQW18AN7N2C80D		7.2				
	LQW18AN7N2G80D						
	LQW18AN7N5C80D	7.5					
	LQW18AN7N5G80D						

Customer Part Number	MURATA Part Number	Inductance		Q (min.)	DC Resistance ( $\Omega$ max.)	Self Resonant Frequency (MHz min.)	Rated Current (mA)
		(nH)	Tolerance				
	LQW18AN8N2C80D	8.2	C: $\pm$ 0.2nH G: $\pm$ 2%	38	0.052	4750	1600
	LQW18AN8N2G80D						
	LQW18AN8N4C80D	8.4					
	LQW18AN8N4G80D						
	LQW18AN8N7C80D	8.7					
	LQW18AN8N7G80D						
	LQW18AN9N1C80D	9.1					
	LQW18AN9N1G80D						
	LQW18AN9N5C80D	9.5					
	LQW18AN9N5G80D						
	LQW18AN9N9C80D	9.9					
	LQW18AN9N9G80D						
	LQW18AN10NG80D	10	G: $\pm$ 2% J: $\pm$ 5%	40	0.064	5000	1500
	LQW18AN10NJ80D						
	LQW18AN11NG80D	11					
	LQW18AN11NJ80D						
	LQW18AN12NG80D	12					
	LQW18AN12NJ80D						
	LQW18AN13NG80D	13					
	LQW18AN13NJ80D						
	LQW18AN15NG80D	15					
	LQW18AN15NJ80D						
	LQW18AN16NG80D	16					
	LQW18AN16NJ80D						
	LQW18AN17NG80D	17					
	LQW18AN17NJ80D						
	LQW18AN18NG80D	18					
	LQW18AN18NJ80D						
	LQW18AN19NG80D	19					
	LQW18AN19NJ80D						
	LQW18AN22NG80D	22					
	LQW18AN22NJ80D						
	LQW18AN23NG80D	23					
	LQW18AN23NJ80D						
	LQW18AN24NG80D	24					
	LQW18AN24NJ80D						
	LQW18AN25NG80D	25					
	LQW18AN25NJ80D						
	LQW18AN27NG80D	27					
	LQW18AN27NJ80D						
	LQW18AN28NG80D	28					
	LQW18AN28NJ80D						
	LQW18AN30NG80D	30					
	LQW18AN30NJ80D						

Customer Part Number	MURATA Part Number	Inductance		Q (min.)	DC Resistance ( $\Omega$ max.)	Self Resonant Frequency (MHz min.)	Rated Current (mA)	
		(nH)	Tolerance					
	LQW18AN31NG80D	31	G: $\pm$ 2% J: $\pm$ 5%	40	0.11	3150	1100	
	LQW18AN31NJ80D							
	LQW18AN33NG80D	33			0.15	3000		1050
	LQW18AN33NJ80D							
	LQW18AN34NG80D	34		37	0.20	910		
	LQW18AN34NJ80D							
	LQW18AN36NG80D	36		40	0.16	1000		
	LQW18AN36NJ80D							
	LQW18AN37NG80D	37		40	0.21	840		
	LQW18AN37NJ80D							
	LQW18AN39NG80D	39		40	0.23	830		
	LQW18AN39NJ80D							
	LQW18AN41NG80D	41		40	0.27	750		
	LQW18AN41NJ80D							
	LQW18AN43NG80D	43		40	0.26	770		
	LQW18AN43NJ80D							
	LQW18AN44NG80D	44		32	0.30	700		
	LQW18AN44NJ80D							
	LQW18AN47NG80D	47		37	0.38	630		
	LQW18AN47NJ80D							
	LQW18AN48NG80D	48	34	0.47	560			
	LQW18AN48NJ80D							
	LQW18AN51NG80D	51	28	0.41	590			
	LQW18AN51NJ80D							
	LQW18AN52NG80D	52	34	0.5	550			
	LQW18AN52NJ80D							
	LQW18AN56NG80D	56	33	0.54	520			
	LQW18AN56NJ80D							
	LQW18AN58NG80D	58						
	LQW18AN58NJ80D							
	LQW18AN68NG80D	68						
	LQW18AN68NJ80D							
	LQW18AN69NG80D	69						
	LQW18AN69NJ80D							
	LQW18AN72NG80D	72						
	LQW18AN72NJ80D							
	LQW18AN73NG80D	73						
	LQW18AN73NJ80D							
	LQW18AN75NG80D	75						
	LQW18AN75NJ80D							
	LQW18AN78NG80D	78						
	LQW18AN78NJ80D							
	LQW18AN82NG80D	82						
	LQW18AN82NJ80D							
	LQW18AN83NG80D	83						
	LQW18AN83NJ80D							
	LQW18AN91NG80D	91						
	LQW18AN91NJ80D							

Customer Part Number	MURATA Part Number	Inductance		Q (min.)	DC Resistance ( $\Omega$ max.)	Self Resonant Frequency (MHz min.)	Rated Current (mA)
		(nH)	Tolerance				
	LQW18AN94NG80D	94	G: $\pm$ 2% J: $\pm$ 5%	34	0.63	1750	490
	LQW18AN94NJ80D						
	LQW18ANR10G80D						
	LQW18ANR10J80D						
	LQW18ANR11G80D	110		32	0.7	1730	450
	LQW18ANR11J80D						
	LQW18ANR12G80D	120		28	0.72	1650	420
	LQW18ANR12J80D						
	LQW18ANR15G80D	150		25	0.87	1580	310
	LQW18ANR15J80D						
	LQW18ANR18G80D	180		25	1.65	1380	290
	LQW18ANR18J80D						
	LQW18ANR20G80D	200		27	1.74	1350	280
	LQW18ANR20J80D						
	LQW18ANR21G80D	210		25	1.98	1330	250
	LQW18ANR21J80D						
	LQW18ANR22G80D	220		24	2.08	1250	260
	LQW18ANR22J80D						
	LQW18ANR25G80D	250		24	2.28	1200	220
	LQW18ANR25J80D						
	LQW18ANR27G80D	270	25	2.42	1100	190	
	LQW18ANR27J80D						
	LQW18ANR30G80D	300	25	3.12	1050	190	
	LQW18ANR30J80D						
	LQW18ANR33G80D	330	25	3.84	1050	190	
	LQW18ANR33J80D						
	LQW18ANR36G80D	360	25	3.98	1050	190	
	LQW18ANR36J80D						
	LQW18ANR39G80D	390	25	4.23	1100	190	
	LQW18ANR39J80D						

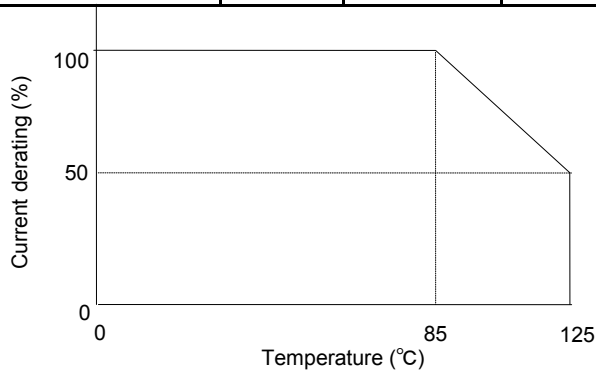

Derating of Rated Current depend on Operating Temperature

#### 4. Testing Conditions

《Unless otherwise specified》

Temperature : Ordinary Temperature / 15°C to 35°C

Humidity : Ordinary Humidity / 25%(RH) to 85%(RH)

《In case of doubt》

Temperature : 20°C $\pm$ 2°C

Humidity : 60%(RH) to 70%(RH)

Atmospheric Pressure : 86kPa to 106 kPa

5. Appearance and Dimensions

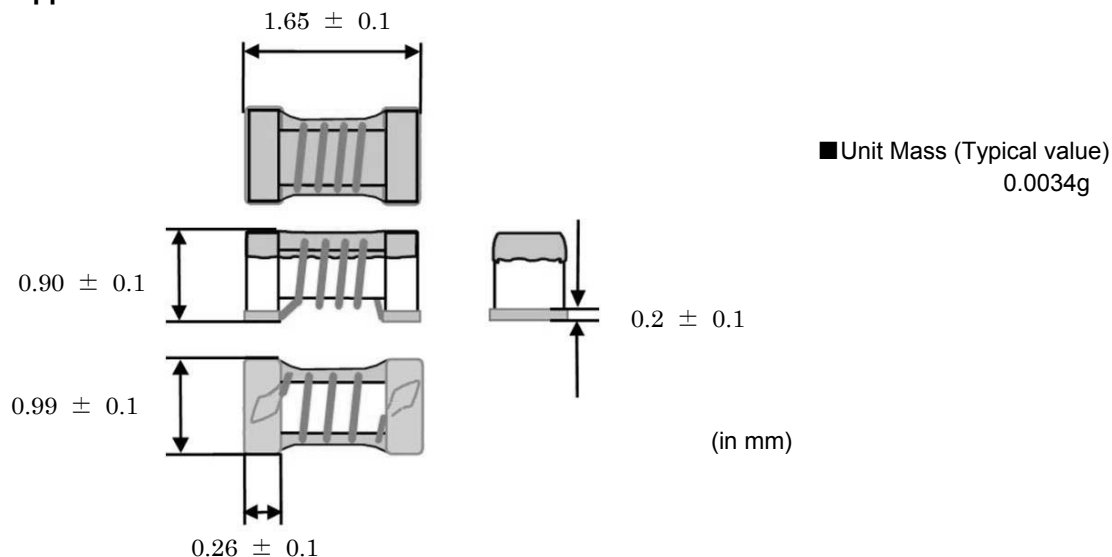

6. Electrical Performance

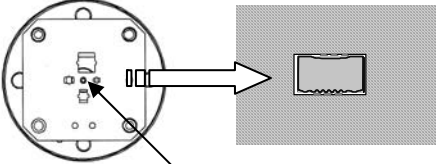
No.	Item	Specification	Test Method
6.1	Inductance	Inductance shall meet item 3.	Measuring Equipment: Agilent 4287A or equivalent Measuring Frequency: <Inductance> 100MHz <Q> 250MHz/ 2.2nH~44nH 200MHz/ 47nH~69nH 150MHz/ 72nH~150nH 100MHz/ 180nH~390nH Measuring Condition: Test signal level / about 10mA Electrical length / 0.94 cm Measuring Fixture: Agilent 16197A Position coil under test as shown in below and contact coil with each terminal by adding weight.
6.2	Q	Q shall meet item 3.	 <p>1608 Size Guide</p> Measuring Method: See P.12 <Electrical Performance: Measuring Method of Inductance/Q>
6.3	DC Resistance	DC Resistance shall meet item 3.	Measuring Equipment: Digital multi meter
6.4	Self Resonant Frequency(S.R.F)	S.R.F shall meet item 3.	Measuring Equipment: Agilent 5230A or equivalent
6.5	Rated Current	Self temperature rise shall be limited to 40°C max.	The rated current is applied.

## 7. Mechanical Performance

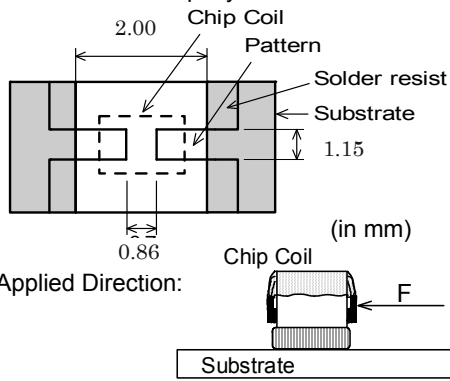
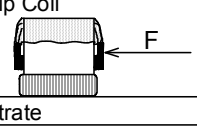
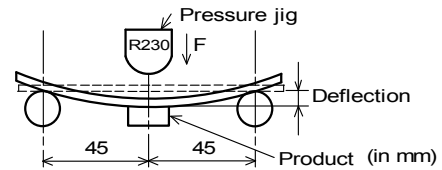
No.	Item	Specification	Test Method
7.1	Shear Test	Chip coil shall not be damaged after tested as test method.	Substrate: Glass-epoxy substrate  Applied Direction:  Force: 5N Hold Duration: 5s±1s
7.2	Bending Test		Substrate: Glass-epoxy substrate (100mm × 40mm × 1.6mm) Speed of Applying Force: 1mm / s Deflection: 2mm Hold Duration: 30s  Deflection Product (in mm)
7.3	Vibration	Chip coil shall not be damaged after tested as test method.	Oscillation Frequency: 10Hz~55Hz~10Hz for 1 min Total Amplitude: 1.5mm Testing Time: A period of 2 hours in each of 3 mutually perpendicular directions.
7.4	Solderability	The wetting area of the electrode shall be at least 90% covered with new solder coating.	Flux: Ethanol solution of rosin, 25(wt)% Includes activator equivalent to 0.06(wt)% chlorine. (immersed for 5s to 10s) Solder: Sn-3.0Ag-0.5Cu Pre-Heating: 150°C±10°C / 60s to 90s Solder Temperature: 240°C±5°C Immersion Time: 3s±1s
7.5	Resistance to Soldering Heat	Appearance: No damage Inductance Change: within ±5%	Flux: Ethanol solution of rosin, 25(wt)% Includes activator equivalent to 0.06(wt)% Chlorine. (immersed for 5s to 10s) Solder: Sn-3.0Ag-0.5Cu Pre-Heating: 150°C±10°C / 60s to 90s Solder Temperature: 270°C±5°C Immersion Time: 10s±1s Then measured after exposure in the room condition for 24h±2h.

## 8. Environmental Performance

It shall be soldered on the substrate.

No.	Item	Specification	Test Method
8.1	Heat Resistance	Appearance: No damage Inductance Change: within ±5% Q Change: within ±20%	Temperature: 125°C±2°C Time: 1000h (+48h, 0h) Then measured after exposure in the room condition for 24h±2h.

No.	Item	Specification	Test Method
8.2	Cold Resistance	Appearance:No damage Inductance Change: within ±5% Q Change: within ±20%	Temperature:-55°C±2°C Time:1000h (+48h,-0h) Then measured after exposure in the room condition for 24h±2h.
8.3	Humidity		Temperature: 40°C±2°C Humidity: 90%(RH) to 95%(RH) Time:1000h (+48h,-0h) Then measured after exposure in the room condition for 24h±2h.
8.4	Temperature Cycle		1 cycle: 1 step:-55°C±2°C / 30min±3 min 2 step:Ordinary temp. / 10min to 15 min 3 step:+125°C±2°C / 30min±3 min 4 step:Ordinary temp. / 10min to 15 min Total of 10 cycles Then measured after exposure in the room condition for 24h±2h.

## 9.Specification of Packaging

### 9.1 Appearance and Dimensions of paper tape (8mm-wide)

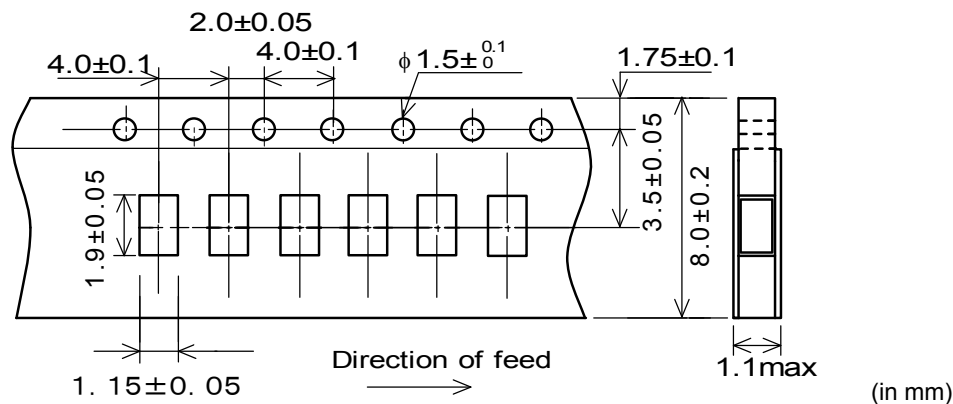

### 9.2 Specification of Taping

- (1) Packing quantity (standard quantity)  
4,000 pcs. / reel
- (2) Packing Method  
Products shall be packed in the cavity of the base tape and sealed by top tape and bottom tape.
- (3) Sprocket hole  
The sprocket holes are to the right as the tape is pulled toward the user.
- (4) Spliced point  
Base tape and Top tape has no spliced point.
- (5) Missing components number  
Missing components number within 0.1 % of the number per reel or 1 pc., whichever is greater, and are not continuous. The Specified quantity per reel is kept.

### 9.3 Pull Strength

Top tape	5N min.
Bottom tape	

### 9.4 Peeling off force of cover tape

Speed of Peeling off	300mm/min
Peeling off force	0.1N to 0.6N (minimum value is typical)

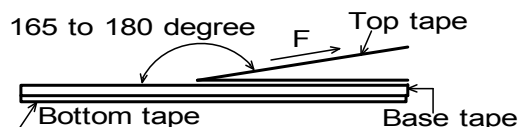

### 9.5 Dimensions of Leader-tape, Trailer and Reel

There shall be leader-tape ( top tape and empty tape) and trailer-tape (empty tape) as follows.

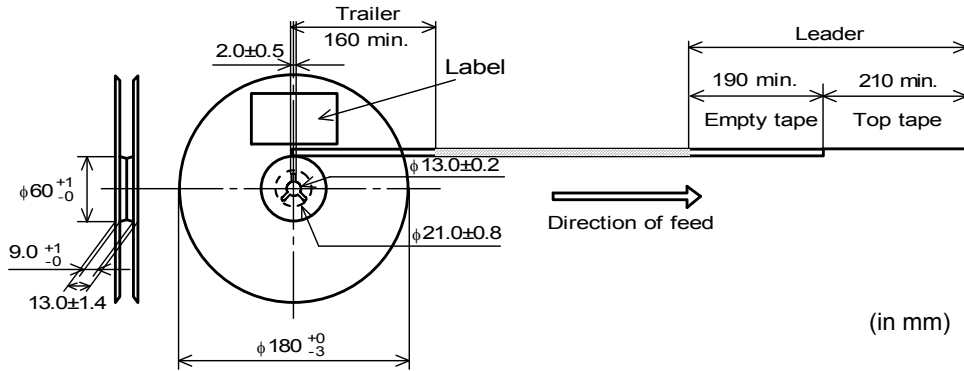

### 9.6 Marking for reel

Customer part number, MURATA part number, Inspection number(\*1) ,RoHS Marking (\*2), Quantity etc ...

\*1) <Expression of Inspection No.>

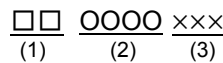

- (1) Factory code
- (2) Date      First digit: Year / Last digit of year  
                   Second digit: Month / Jan. to Sep. → 1 to 9, Oct. to Dec. → O, N, D  
                   Third, Fourth digit : Day
- (3) Serial No.

\*2) <Expression of RoHS Marking >

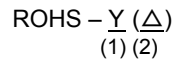

- (1) RoHS regulation conformity parts.
- (2) MURATA classification number

### 9.7 Marking for Outside package (corrugated paper box)

Customer name, Purchasing order number, Customer part number, MURATA part number, RoHS Marking (\*2) ,Quantity, etc ...

### 9.8. Specification of Outer Case

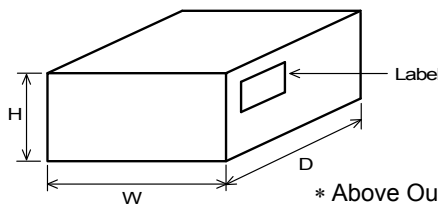

Outer Case Dimensions (mm)			Standard Reel Quantity in Outer Case (Reel)
W	D	H	
186	186	93	5

\* Above Outer Case size is typical. It depends on a quantity of an order.

## 10. ⚠ Caution

### Limitation of Applications

Please contact us before using our products for the applications listed below which require especially high reliability for the prevention of defects which might directly cause damage to the third party's life, body or property.

- |   |   |
|---|---|
| <ul style="list-style-type: none"> <li>(1) Aircraft equipment</li> <li>(2) Aerospace equipment</li> <li>(3) Undersea equipment</li> <li>(4) Power plant control equipment</li> <li>(5) Medical equipment</li> </ul> | <ul style="list-style-type: none"> <li>(6) Transportation equipment (vehicles, trains, ships, etc.)</li> <li>(7) Traffic signal equipment</li> <li>(8) Disaster prevention / crime prevention equipment</li> <li>(9) Data-processing equipment</li> <li>(10) Applications of similar complexity and /or reliability requirements to the applications listed in the above</li> </ul> |
|---|---|



## 11. Notice

Products can only be soldered with reflow.

This product is designed for solder mounting.

Please consult us in advance for applying other mounting method such as conductive adhesive.

### 11.1 Land pattern designing

Recommended land patterns for reflow soldering are as follows:

These have been designed for Electric characteristics and solderability.

Please follow the recommended patterns. Otherwise, their performance which includes electrical performance or solderability may be affected, or result to "position shift" in soldering process.

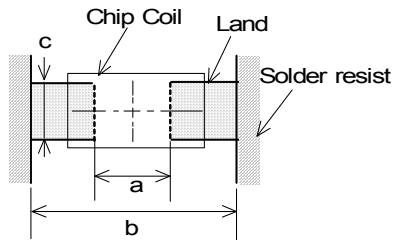

a	0.86
b	2.00
c	1.15

(in mm)

### 11.2 Flux, Solder

- Use rosin-based flux.

Includes middle activator equivalent to 0.06(wt)% to 0.1(wt)% Chlorine.

Don't use highly acidic flux with halide content exceeding 0.2(wt)% (chlorine conversion value).

Don't use water-soluble flux.

- Use Sn-3.0Ag-0.5Cu solder.

- Standard thickness of solder paste : 100  $\mu$ m to 150  $\mu$ m.

### 11.3 Reflow soldering conditions

- Pre-heating should be in such a way that the temperature difference between solder and product surface is limited to 150°C max. Cooling into solvent after soldering also should be in such a way that the temperature difference is limited to 100°C max.

Insufficient pre-heating may cause cracks on the product, resulting in the deterioration of products quality.

- Standard soldering profile and the limit soldering profile is as follows.

The excessive limit soldering conditions may cause leaching of the electrode and / or resulting in the deterioration of product quality.

- Reflow soldering profile

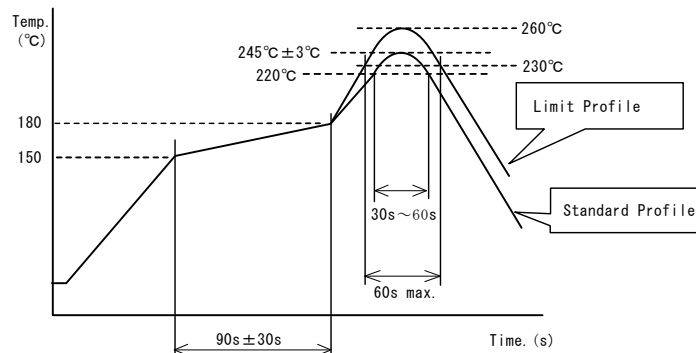

	Standard Profile	Limit Profile
Pre-heating	150°C ~ 180°C , 90s ± 30s	
Heating	above 220°C, 30s ~ 60s	above 230°C, 60s max.
Peak temperature	245°C ± 3°C	260°C, 10s
Cycle of reflow	2 times	

### 11.4 Reworking with soldering iron

The following conditions must be strictly followed when using a soldering iron.

Pre-heating	150°C, 1 min
Tip temperature	350°C max.
Soldering iron output	80W max.
Tip diameter	φ 3mm max.
Soldering time	3(+1, -0)s
Time	2 times

Note :Do not directly touch the products with the tip of the soldering iron in order to prevent the crack on the products due to the thermal shock.

### 11.5 Solder Volume

- Solder shall be used not to be exceeded the upper limits as shown below.
- Accordingly increasing the solder volume, the mechanical stress to Chip is also increased. Exceeding solder volume may cause the failure of mechanical or electrical performance.

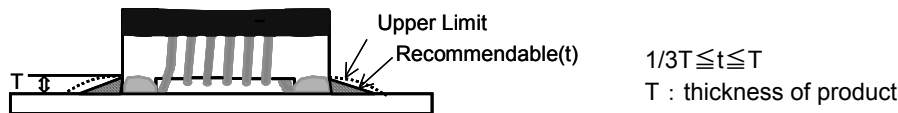

### 11.6 Product's location

The following shall be considered when designing and laying out P.C.B.'s.

- (1) P.C.B. shall be designed so that products are not subject to the mechanical stress due to warping the board.

[Products direction]

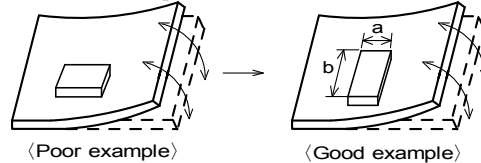

Products shall be located in the sideways direction (Length:  $a < b$ ) to the mechanical stress.

- (2) Products location on P.C.B. separation

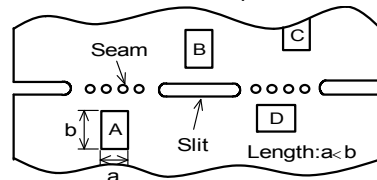

Products (A,B,C,D) shall be located carefully so that products are not subject to the mechanical stress due to warping the board. Because they may be subjected the mechanical stress in order of  $A > C > B \cong D$ .

### 11.7 Cleaning Conditions

Products shall be cleaned on the following conditions.

- (1) Cleaning temperature shall be limited to 60°C max. (40°C max for IPA)
- (2) Ultrasonic cleaning shall comply with the following conditions with avoiding the resonance phenomenon at the mounted products and P.C.B.  
Power : 20 W / l max.    Frequency : 28kHz to 40kHz    Time : 5 min max.
- (3) Cleaner
  1. Alcohol type cleaner  
Isopropyl alcohol (IPA)
  2. Aqueous agent  
PINE ALPHA ST-100S
- (4) There shall be no residual flux and residual cleaner after cleaning.  
In the case of using aqueous agent, products shall be dried completely after rinse with de-ionized water in order to remove the cleaner.
- (5) Other cleaning    Please contact us.

**11.8 Resin coating**

The inductance value may change due to high cure-stress of resin to be used for coating/molding products. An open circuit issue may occur by mechanical stress caused by the resin, amount/cured shape of resin, or operating condition etc. Some resin contains some impurities or chloride possible to generate chlorine by hydrolysis under some operating condition may cause corrosion of wire of coil, leading to open circuit. So, please pay your careful attention in when you select resin in case of coating/molding the products with the resin. Prior to use the coating resin, please make sure no reliability issue is observed by evaluating products mounted on your board.

**11.9 Caution for use**

- Sharp material such as a pair of tweezers or other material such as bristles of cleaning brush , shall not be touched to the winding portion to prevent the breaking of wire.
- Mechanical shock should not be applied to the products mounted on the board to prevent the breaking of the core.

**11.10 Notice of product handling at mounting**

In some mounting machines,when picking up components support pin pushes up the components from the bottom of base tape. In this case, please remove the support pin. The support pin may damage the components and break wire.

In rare case ,the laser recognition can not recognize this component. Please contact us when you use laser recognition. (There is no problem with the permeation and reflection type.)

**11.11 Handling of a substrate**

After mounting products on a substrate, do not apply any stress to the product caused by bending or twisting to the substrate when cropping the substrate, inserting and removing a connector from the substrate or tightening screw to the substrate.

Excessive mechanical stress may cause cracking in the product.

Bending

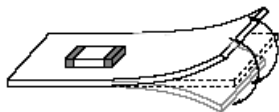

Twisting

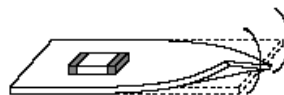
**11.12 Storage and Handling Requirements****(1) Storage period**

- Use the products within 12 months after delivered.
- Solderability should be checked if this period is exceeded.

**(2) Storage conditions**

- Products should be stored in the warehouse on the following conditions.
  - Temperature : -10°C to 40°C
  - Humidity : 15% to 85% relative humidity No rapid change on temperature and humidity
- Don't keep products in corrosive gases such as sulfur, chlorine gas or acid, or it may cause oxidization of electrode, resulting in poor solderability.
- Products should not be stored on bulk packaging condition to prevent the chipping of the core and the breaking of winding wire caused by the collision between the products.
- Products should be stored on the palette for the prevention of the influence from humidity, dust and so on.
- Products should be stored in the warehouse without heat shock, vibration, direct sunlight and so on.

**(3) Handling Condition**

- Care should be taken when transporting or handling product to avoid excessive vibration or mechanical shock.

**12.⚠ Note**

- (1)Please make sure that your product has been evaluated in view of your specifications with our product being mounted to your product.
- (2)You are requested not to use our product deviating from the reference specifications.
- (3)The contents of this reference specification are subject to change without advance notice.  
Please approve our product specifications or transact the approval sheet for product specifications before ordering.

**<Electrical Performance:Measuring Method of Inductance / Q>**

(1) Residual elements and stray elements of test fixture can be described by F-parameter shown in following.

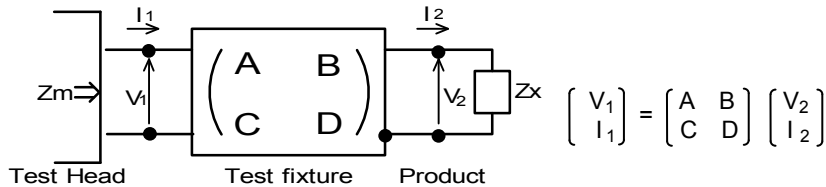

(2) The impedance of chip coil  $Z_x$  and measured value  $Z_m$  can be described by input/output current/voltage.

$$Z_m = \frac{V_1}{I_1} \quad , \quad Z_x = \frac{V_2}{I_2}$$

(3) Thus,the relation between  $Z_x$  and  $Z_m$  is following;

$$Z_x = \alpha \frac{Z_m - \beta}{1 - Z_m \Gamma} \quad \text{where, } \alpha = D / A = 1$$

$$\beta = B / D = Z_{sm} - (1 - Y_{om} Z_{sm}) Z_{ss}$$

$$\Gamma = C / A = Y_{om}$$

$Z_{sm}$ :measured impedance of short chip  
 $Z_{ss}$ :residual impedance of short chip (0.771nH)  
 $Y_{om}$ :measured admittance when opening the fixture

(4)  $L_x$  and  $Q_x$  shall be calculated with the following equation.

$$L_x = \frac{\text{Im}(Z_x)}{2 \pi f} \quad , \quad Q_x = \frac{\text{Im}(Z_x)}{\text{Re}(Z_x)}$$

$L_x$  :Inductance of chip coil  
 $Q_x$ :Q of chip coil  
 $f$  :Measuring frequency