

MARKING  
SEE NOTE 13

CIRCUIT A1  
IDENTIFIER  
INVERTED APPLICATION

NOTES:

- 1) MATERIALS:  
HOUSING - LIQUID CRYSTAL POLYMER, UL94 V-0  
WAFER DIELECTRIC - LIQUID CRYSTAL POLYMER, UL94 V-0  
CONTACT - COPPER ALLOY
- 2) FINISHES  
SEE SHEET 2
- 3) PRODUCT SPECIFICATION  
THIS PART CONFORMS TO MOLEX SPECIFICATION PS-75018-001.
- 4) PACKAGING SPECIFICATION  
THIS PART TO BE PACKAGED PER SPECIFICATION PK-75020-030.
- 5) APPLICATION SPECIFICATION  
THIS PART TO BE APPLIED PER SPECIFICATION AS-75018-001.  
APPLICATION TOOL AND INSTRUCTIONS PER AS-75018-001.
- 6) MATING INFORMATION  
THIS PART MATES WITH 75018-XXXX & 75140-XXXX.  
WILL MATE WITH MAXIMUM OF 1.27mm MIS-ALIGNMENT  
WILL MATE WITH MAXIMUM 0.5° MIS-ALIGNMENT
- 7) ORIENTATION  
THIS PART CAN BE USED IN A STANDARD OR INVERTED  
ORIENTATION (I.E. ROTATED 180°)
- 8) SEE SHEET 3 FOR PCB LAYOUT INFORMATION
- 9) SEE SHEET 4 FOR CIRCUIT DESIGNATION
- 10) CIRCUITS IN THIS ZONE HAVE BEEN OMITTED TO SIMPLIFY THE  
MODEL. ACTUAL PRODUCT IS FULLY LOADED WITH TERMINALS
- 11) APPLICATION TOOLING KEEP OUT AREA.  
NO COMPONENTS ALLOWED IN THIS AREA.
- 12) CONFORMS TO MOLEX COSMETIC SPECIFICATION PS-45499-002 &  
PS-45499-003, CLASS C.
- 13) MARKING: PART NUMBER, MOLEX LOGO, DATE CODE
- 14) RECOMMENDED DRILL SIZE 0.66±0.03 TO  
YIELD FINISHED PLATED THROUGH HOLE 0.55±0.05

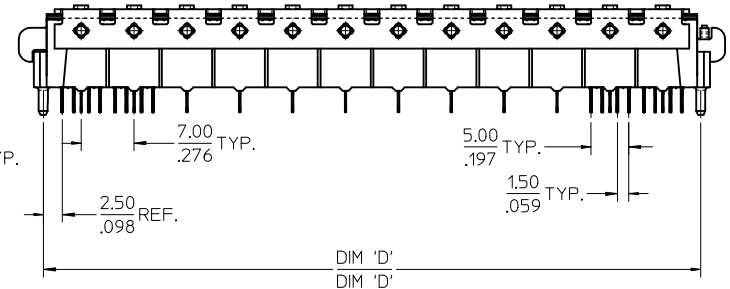
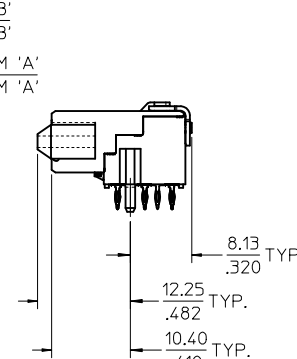
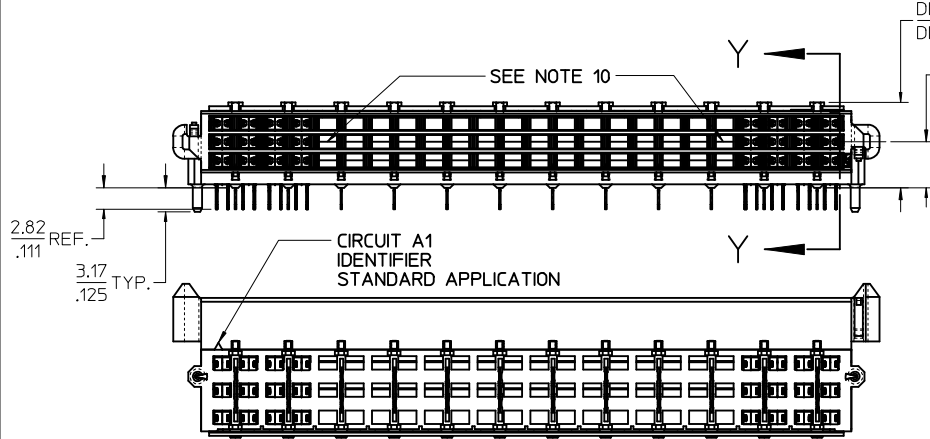

UPDATE TO NEW LOWER HSG EC NO: UCP2014-2233 DRWNR:WHIPPLE 2013/11/21 CHKD:WPOFF 2013/11/21 APPR:SMILLER 2013/11/27	QUALITY SYMBOLS ▽=0 ▽=0 ▽=0	GENERAL TOLERANCES (UNLESS SPECIFIED)		DIMENSION STYLE		SCALE	DESIGN UNITS	THIRD ANGLE PROJECTION		
				MM/IN		2:1	METRIC	PLATEAU HS DOCK FLOATING CONNECTOR  <b>molex</b>		
				DRAWN BY DATE		TITLE				
				LANG 02-NOV-25		CHECKED BY DATE		DOCUMENT NO.		SHEET NO.
		LANG 02-NOV-26		APPROVED BY DATE		SD-75019-010		1 OF 4		
		LANG 02-NOV-26		MATERIAL NO.		SEE TABLE		THIS DRAWING CONTAINS INFORMATION THAT IS PROPRIETARY TO MOLEX INCORPORATED AND SHOULD NOT BE USED WITHOUT WRITTEN PERMISSION		
		ANGULAR ±1/2°		SIZE						
		DRAFT WHERE APPLICABLE MUST REMAIN WITHIN DIMENSIONS		C						

LEAD-FREE ASSEMBLIES - PLATING FINISH 1 - OBSOLETE

ITEM NUMBER	CIRCUIT SIZE	NO. OF COLUMNS 'N'	CENTERLINE DIMENSION 'A' mm(in)	O/A HEIGHT DIMENSION 'B' mm(in)	O/A LENGTH DIMENSION 'C' mm(in)	PEG TO PEG DIMENSION 'D' mm(in)	FIRST-LAST DIMENSION 'E' mm(in)
<del>75019-0015</del>	<del>144</del>	<del>24</del>	<del>4.74 (.187)</del>	<del>9.98 (.393)</del>	<del>93.50 (3.681)</del>	<del>87.00 (3.425)</del>	<del>82.00 (3.228)</del>
<del>75019-0016</del>	<del>144</del>	<del>24</del>	<del>6.09 (.240)</del>	<del>11.33 (.446)</del>	<del>93.50 (3.681)</del>	<del>87.00 (3.425)</del>	<del>82.00 (3.228)</del>
<del>75019-0014</del>	<del>120</del>	<del>20</del>	<del>4.74 (.187)</del>	<del>9.98 (.393)</del>	<del>79.50 (3.130)</del>	<del>73.00 (2.874)</del>	<del>68.00 (2.677)</del>
<del>75019-0013</del>	<del>108</del>	<del>18</del>	<del>4.74 (.187)</del>	<del>9.98 (.393)</del>	<del>72.50 (2.854)</del>	<del>66.00 (2.598)</del>	<del>61.00 (2.402)</del>
<del>75019-0017</del>	<del>108</del>	<del>18</del>	<del>6.09 (.240)</del>	<del>11.33 (.446)</del>	<del>72.50 (2.854)</del>	<del>66.00 (2.598)</del>	<del>61.00 (2.402)</del>

LEAD-FREE ASSEMBLIES

ITEM NUMBER	CIRCUIT SIZE	NO. OF COLUMNS 'N'	CENTERLINE DIMENSION 'A' mm(in)	O/A HEIGHT DIMENSION 'B' mm(in)	O/A LENGTH DIMENSION 'C' mm(in)	PEG TO PEG DIMENSION 'D' mm(in)	FIRST-LAST DIMENSION 'E' mm(in)	PLATING FINISH
75019-7013	108	18	4.74 (.187)	9.98 (.393)	72.50 (2.854)	66.00 (2.598)	61.00 (2.402)	FINISH 2
75019-7213	108	18	4.74 (.187)	9.98 (.393)	72.50 (2.854)	66.00 (2.598)	61.00 (2.402)	FINISH 2
75019-7214	120	20	4.74 (.187)	9.98 (.393)	79.50 (3.130)	73.00 (2.874)	68.00 (2.677)	FINISH 2
75019-7215	144	24	4.74 (.187)	9.98 (.393)	93.50 (3.681)	87.00 (3.425)	82.00 (3.228)	FINISH 2
75019-7216	144	24	6.09 (.240)	11.33 (.446)	93.50 (3.681)	87.00 (3.425)	82.00 (3.228)	FINISH 2
75019-7217	108	18	6.09 (.240)	11.33 (.446)	72.50 (2.854)	66.00 (2.598)	61.00 (2.402)	FINISH 2
75019-7313	108	18	4.74 (.187)	9.98 (.393)	72.50 (2.854)	66.00 (2.598)	61.00 (2.402)	FINISH 3
75019-7314	120	20	4.74 (.187)	9.98 (.393)	79.50 (3.130)	73.00 (2.874)	68.00 (2.677)	FINISH 3
75019-7315	144	24	4.74 (.187)	9.98 (.393)	93.50 (3.681)	87.00 (3.425)	82.00 (3.228)	FINISH 3
75019-7316	144	24	6.09 (.240)	11.33 (.446)	93.50 (3.681)	87.00 (3.425)	82.00 (3.228)	FINISH 3
75019-7317	108	18	6.09 (.240)	11.33 (.446)	72.50 (2.854)	66.00 (2.598)	61.00 (2.402)	FINISH 3

1) FINISHES  
 FINISH 1 (PREVIOUSLY TIN-LEAD)  
 CONTACT INTERFACE  
 0.76 MICROMETER MINIMUM SELECT GOLD OVER  
 1.27 MICROMETER MINIMUM NICKEL OVERALL  
 COMPLIANT INTERFACE  
 0.76 MICROMETER MINIMUM SELECT MATTE TIN OVER  
 1.27 MICROMETER MINIMUM NICKEL OVERALL  
 HOUSING  
 0.10 MICROMETER MAXIMUM IMMERSION GOLD OVER  
 3.81 MICROMETER MINIMUM NICKEL OVER  
 3.81 MICROMETER MINIMUM COPPER OVERALL  
  
 FINISH 2  
 CONTACT INTERFACE  
 0.76 MICROMETER MINIMUM SELECT GOLD OVER  
 1.27 MICROMETER MINIMUM NICKEL OVERALL  
 COMPLIANT INTERFACE  
 0.76 MICROMETER MINIMUM SELECT MATTE TIN OVER  
 1.27 MICROMETER MINIMUM NICKEL OVERALL  
 HOUSING  
 0.10 MICROMETER MAXIMUM IMMERSION GOLD OVER  
 3.81 MICROMETER MINIMUM NICKEL OVER  
 3.81 MICROMETER MINIMUM COPPER OVERALL  
  
 FINISH 3  
 CONTACT INTERFACE  
 0.76 MICROMETER MINIMUM SELECT GOLD OVER  
 1.27 MICROMETER MINIMUM NICKEL OVERALL  
 COMPLIANT INTERFACE  
 0.76 MICROMETER MINIMUM SELECT MATTE TIN OVER  
 1.27 MICROMETER MINIMUM NICKEL OVERALL  
 HOUSING  
 3.81 MICROMETER MINIMUM NICKEL OVER  
 3.81 MICROMETER MINIMUM COPPER OVERALL

SEE SHEET 1 EC NO: UCP2014-2233 DRWN:RWHIPPLE 2013/11/21 CHKD:MPOFF 2013/11/21 APPR:SMILLER 2013/11/27	QUALITY SYMBOLS ▽=0 ▽=0 ▽=0	GENERAL TOLERANCES (UNLESS SPECIFIED)		DIMENSION STYLE MM/IN		SCALE 1:1	DESIGN UNITS METRIC	THIRD ANGLE PROJECTION			
		4 PLACES ± --- ± ---	3 PLACES ± --- ± .005	DRAWN BY LANG	DATE 02-NOV-25	PLATEAU HS DOCK FLOATING CONNECTOR					
		2 PLACES ± 0.13 ± .01	1 PLACE ± 0.25 ± ---	CHECKED BY LANG	DATE 02-NOV-26						
		0 PLACE ± ±	ANGULAR ±1/2°	APPROVED BY BANAKIS	DATE 02-NOV-26	MATERIAL NO. SEE TABLE		DOCUMENT NO. SD-75019-010	SHEET NO. 2 OF 4		
DRAFT WHERE APPLICABLE MUST REMAIN WITHIN DIMENSIONS		THIS DRAWING CONTAINS INFORMATION THAT IS PROPRIETARY TO MOLEX INCORPORATED AND SHOULD NOT BE USED WITHOUT WRITTEN PERMISSION									

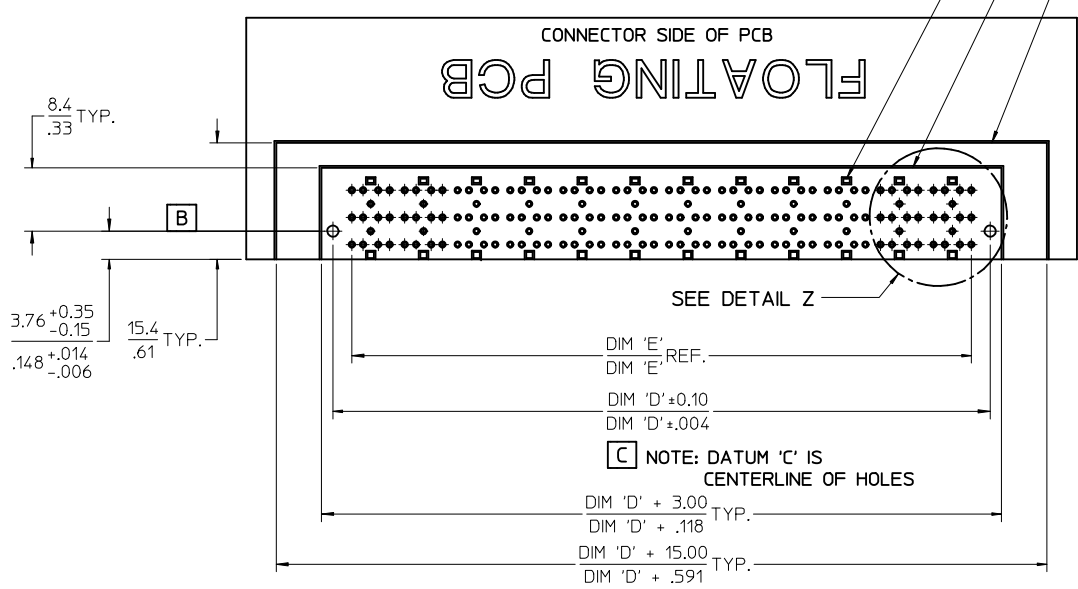

NO EXPOSED TRACES ON SURFACE OF PCB IN CONNECTOR STAND OFF LOCATIONS  
 CONNECTOR KEEP OUT AREA  
 APPLICATION TOOLING KEEP OUT AREA (NOTES 5 & 11)

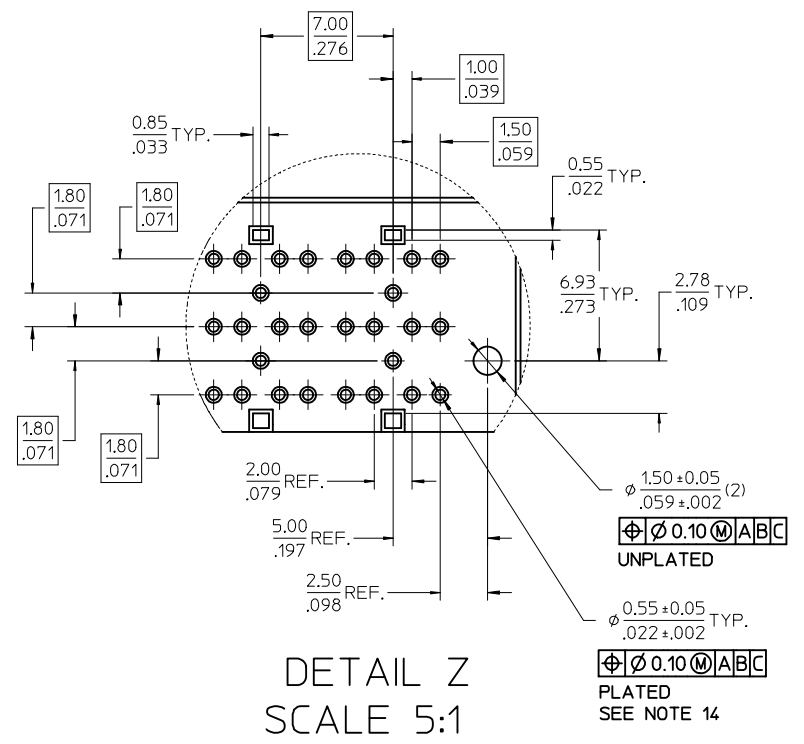
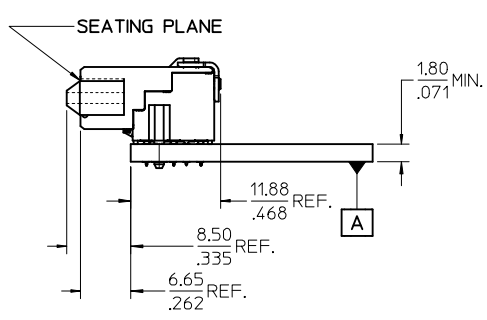
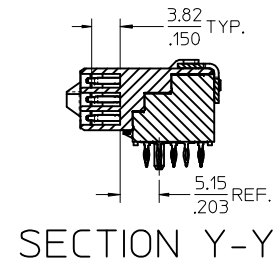

DETAIL Z  
SCALE 5:1

SEE SHEET 1 EC NO: UCP2014-2233 DRWN:RHIPPLE 2013/11/21 CHKD:RPOFF 2013/11/21 APPR:SMILLER 2013/11/27	QUALITY SYMBOLS	GENERAL TOLERANCES (UNLESS SPECIFIED)	DIMENSION STYLE	SCALE	DESIGN UNITS	THIRD ANGLE PROJECTION
	▽=0	mm INCH	MM/IN	2:1	METRIC	
	▽=0	4 PLACES ± --- ± ---	DRAWN BY DATE	TITLE	PLATEAU HS DOCK FLOATING CONNECTOR	
	▽=0	3 PLACES ± --- ±.005	LANG 02-NOV-25			
▽=0	2 PLACES ±.13 ±.01	CHECKED BY DATE	LANG 02-NOV-26	<b>molex</b> DOCUMENT NO. SD-75019-010 SHEET NO. 3 OF 4		
▽=0	1 PLACE ±.25 ± ---	APPROVED BY DATE	BANAKI S 02-NOV-26			
REV	DESCRIPTION	ANGULAR ±1/2°	MATERIAL NO.	THIS DRAWING CONTAINS INFORMATION THAT IS PROPRIETARY TO MOLEX INCORPORATED AND SHOULD NOT BE USED WITHOUT WRITTEN PERMISSION		
		DRAFT WHERE APPLICABLE MUST REMAIN WITHIN DIMENSIONS	SEE TABLE			

# STANDARD APPLICATION CIRCUIT DESIGNATIONS

# INVERTED APPLICATION CIRCUIT DESIGNATIONS

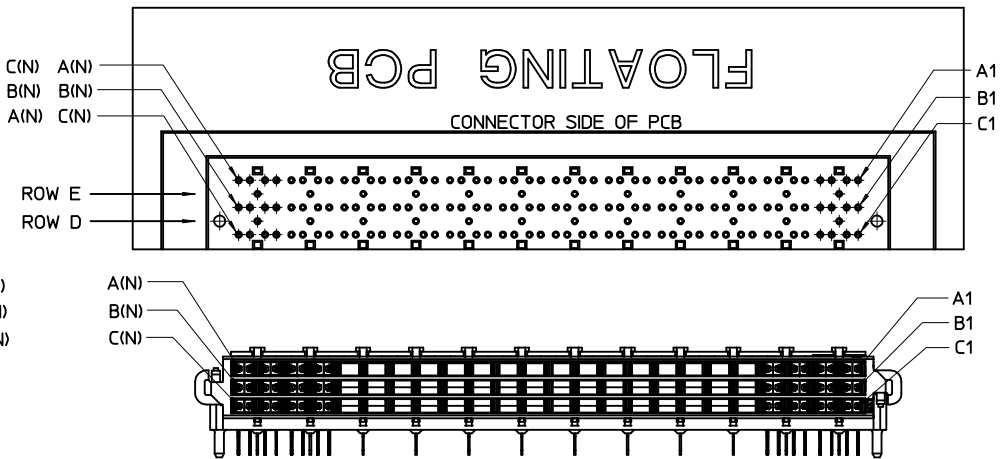
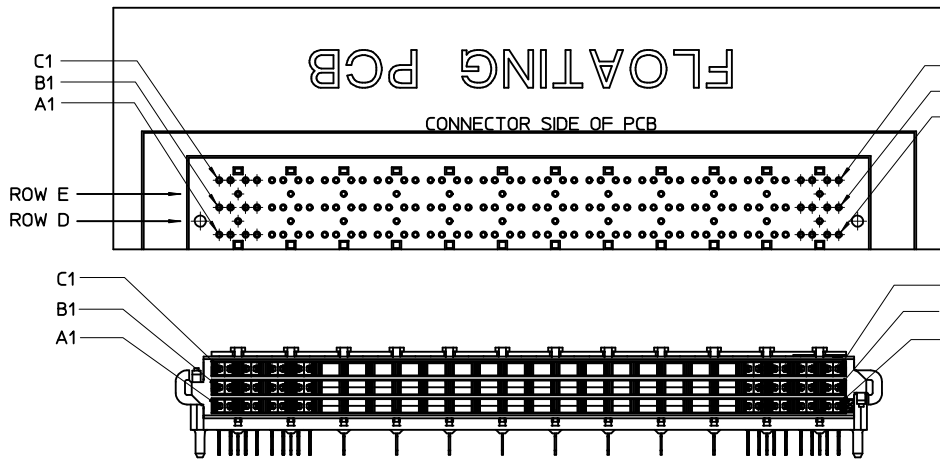
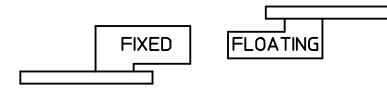
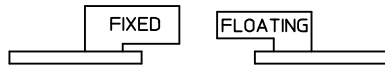

### CIRCUIT DESIGNATION

FIRST MATE: HOUSING - SIGNAL GROUND  
 SECOND MATE: A1, C1, A(N), C(N) (FOR POWER RETURN)  
 THIRD MATE: A2, B2, C2, A(N-1), B(N-1), C(N-1) & ALL OTHERS  
 (A2, C2, A(N-1) & C(N-1) FOR POWER)  
 (ALL OTHERS FOR SIGNAL)  
 LAST MATE: B1, B(N) (FOR CARD DETECT)

ALL COLUMNS FROM 3 THROUGH (N-2) ARE SUITABLE FOR DIFFERENTIAL PAIRS  
 EG: A3-A4, B3-B4, C3-C4, A(N-2)-A(N-3), B(N-2)-B(N-3)

SIGNAL GROUND: ROWS D & E

SEE SHEET 1 EC NO: UCP2014-2233 DRWNR:WHIPPLE 2013/11/21 CHKDR:POFF 2013/11/21 APPR:SMILLER 2013/11/27	QUALITY SYMBOLS ▽=0 ▽=0 ▽=0	GENERAL TOLERANCES (UNLESS SPECIFIED)		DIMENSION STYLE MM/IN		SCALE 2:1	DESIGN UNITS METRIC	THIRD ANGLE PROJECTION		
		4 PLACES ± --- ± ---	LANG	DATE	DRAWN BY		DATE		TITLE PLATEAU HS DOCK FLOATING CONNECTOR	
		3 PLACES ± --- ± .005	CHECKED BY	DATE	LANG		DATE			
		2 PLACES ± 0.13 ± .01	APPROVED BY	DATE	MATERIAL NO.		DOCUMENT NO.		SHEET NO.	
1 PLACE ± 0.25 ± ---	BANAK I S	02-NOV-26	SEE TABLE		SD-75019-010		4 OF 4			
0 PLACE ± ±	ANGULAR ±1/2°		THIS DRAWING CONTAINS INFORMATION THAT IS PROPRIETARY TO MOLEX INCORPORATED AND SHOULD NOT BE USED WITHOUT WRITTEN PERMISSION							
DRAFT WHERE APPLICABLE MUST REMAIN WITHIN DIMENSIONS										