

LC 8 PORT ADAPTER P/N	ADAPTER COLOR	SPLIT SLEEVE MATERIAL
106121-0450	BLUE	CERAMIC
106121-0460	GREEN	CERAMIC
106121-0470	BEIGE	PHOSPHOR BRONZE
106121-0480	AQUA	PHOSPHOR BRONZE

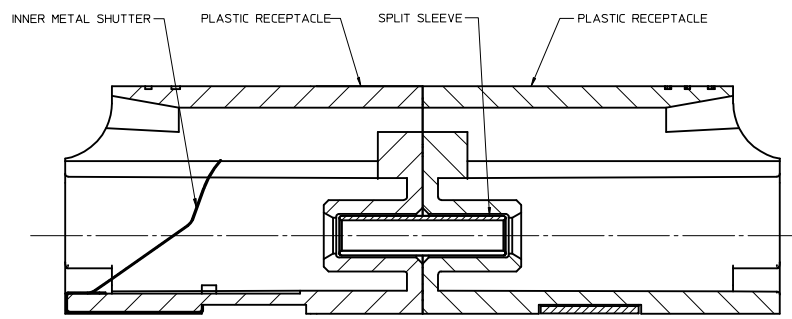

SECTION Z-Z
Scale 10:1

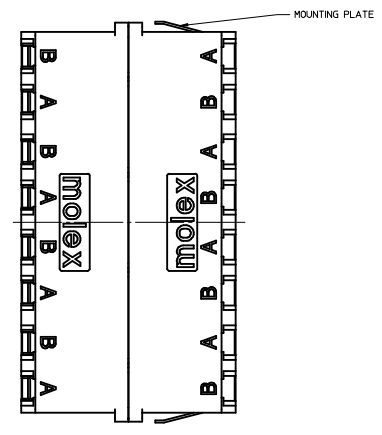
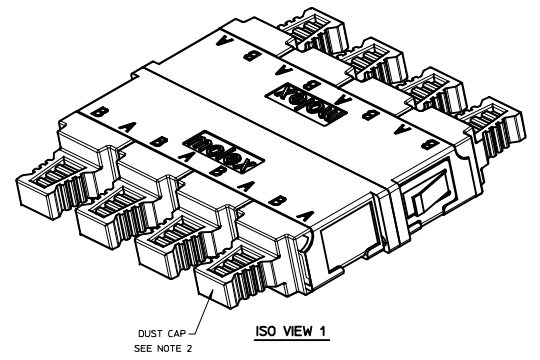
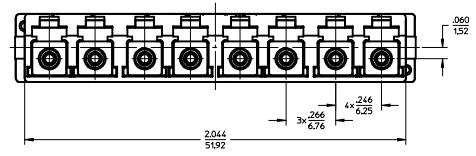
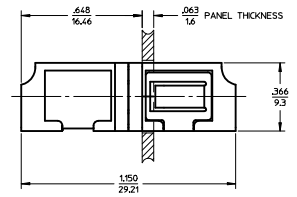
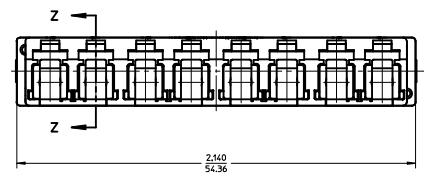

ISO VIEW 1
DUST CAP - SEE NOTE 2

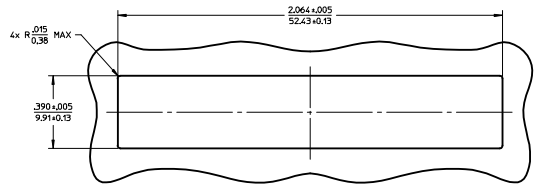

RECOMMENDED MOUNTING PATTERN

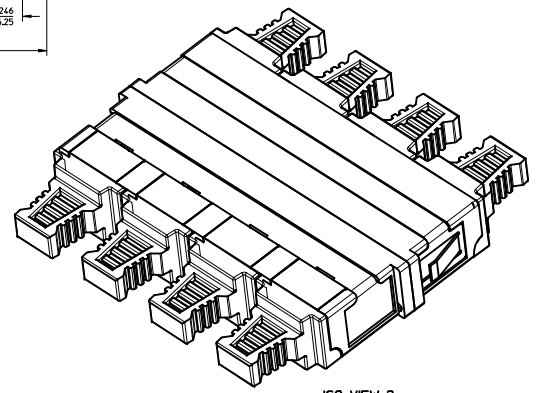

ISO VIEW 2

NOTES:
1. ALL DIMENSIONS ARE FOR REFERENCE.
2. DUST CAPS SHOWN IN ISO VIEWS ONLY.

ENTER DESCRIPTION IEC NO. MF2015-0403 DRAWN BY: YBELNKIY CHKD: WCHEN APPR: WCHEN DATE: 2015/06/16 DATE: 2015/09/25	QUALITY SYMBOLS DESCRIPTION	GENERAL TOLERANCES (UNLESS SPECIFIED)		DIMENSION STYLE IN/MM	SCALE 3:1	DESIGN UNITS INCH	THIRD ANGLE PROJECTION		
		4 PLACES ±--- ±--- 3 PLACES ±--- ±--- 2 PLACES ±--- ±--- 1 PLACE ±--- ±---	mm INCH	DRAWN BY: YBELNKIY DATE: 2012/01/04	CHECKED BY: DATE	TITLE LC 8 PORT ADAPTER SNAP MOUNT INNER SHUTTERS			
		ANGULAR ±---°	DRAFT WHERE APPLICABLE MUST REMAIN WITHIN DIMENSIONS	APPROVED BY: WCHEN DATE: 2012/02/06	MATERIAL NO. SEE TABLE	MOLEX INCORPORATED	DOCUMENT NO. SD-106121-0450	SHEET NO. 1 OF 1	
		THIS DRAWING CONTAINS INFORMATION THAT IS PROPRIETARY TO MOLEX INCORPORATED AND SHOULD NOT BE USED WITHOUT WRITTEN PERMISSION							