

SIDE VIEW OF BOX

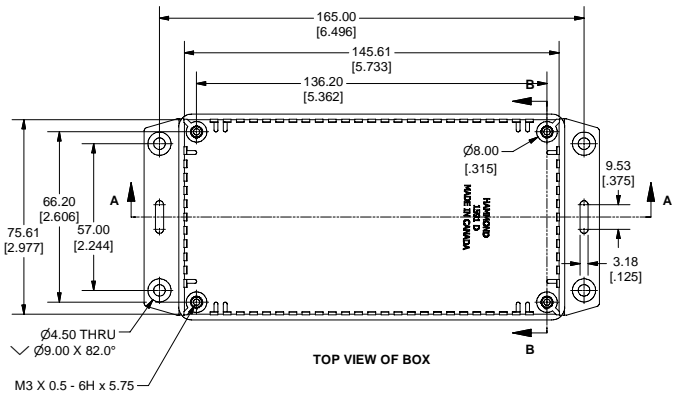

TOP VIEW OF BOX

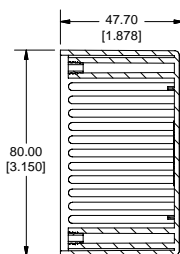

SECTION B-B

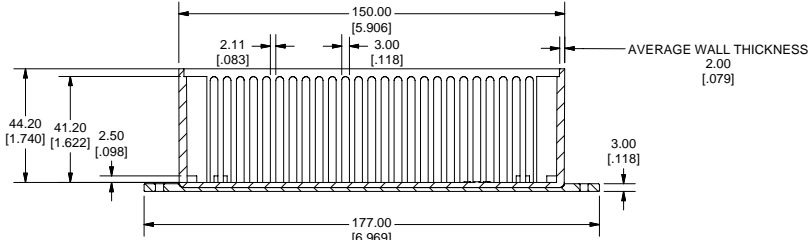
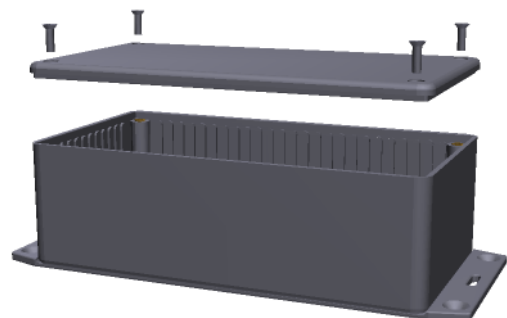

SECTION A-A

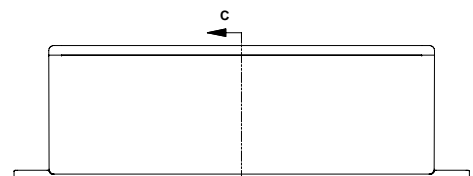

SIDE VIEW OF ASSEMBLY

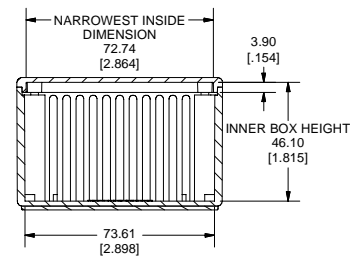

SECTION C-C

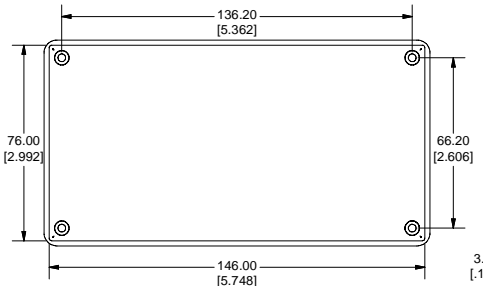

TOP VIEW OF LID

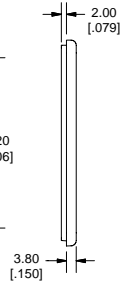

SIDE VIEW OF LID

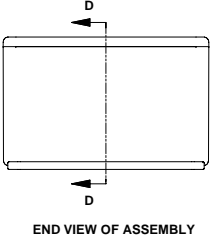

END VIEW OF ASSEMBLY

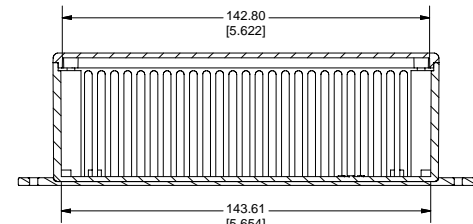

SECTION D-D

Note:
Enclosures can be Factory Modified (Milling, Drilling, Printing etc.)
Contact Factory mjm@hammondmfg.com for quotes
Solid models of this enclosure available in STEP or IGES Format.

PART NUMBERS		
1591D Flanged Box Enclosures		
Material	Colour	Part Number
FR ABS	Black	1591DF2BK
UL94 - V0	Grey	1591DF2GY
GP ABS	Black	1591DF2SBK
	Grey	1591DF2SGY
Accessories		
	Description	Part Number
Universal Use	PC Board Card Adapters	See Accessories Section
	Clear Lids - clear, flame retardant polycarbonate - Lid ONLY	1591DC
FR ABS	Replacement Screws, Flat Head Phillips Nickel Plated Pkg of 100	1591MS100 1591MS100BK (Black)
GP ABS	Self Tapping Pkg of 100	1591TS100 1591TS100BK (Black)
Recommended Torque on Fasteners (no lubrication)		
	M3 - 0.5 x 10mm Screws	30-40 cN*m
	#4 x 0.5 Screws	30-40 cN*m

