

CKT NO	PART NO	DIM A
2	171692-0102	8.35
4	171692-0104	12.05
6	171692-0106	17.75
8	171692-0108	23.45 +0.40
10	171692-0110	29.15 +0.40
12	171692-0112	34.85 +0.40

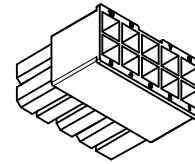

171692-0110

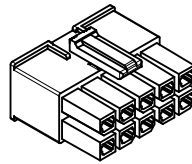
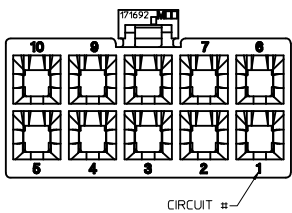
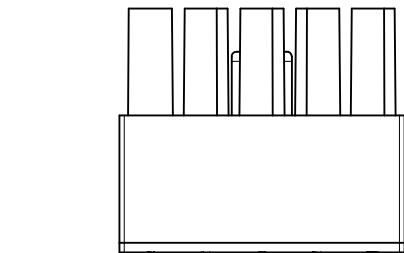
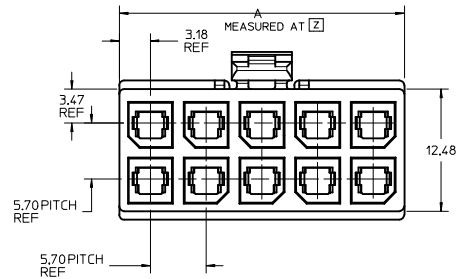
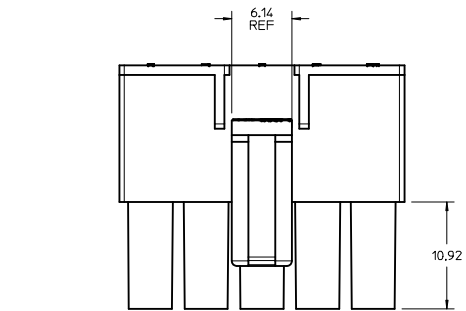
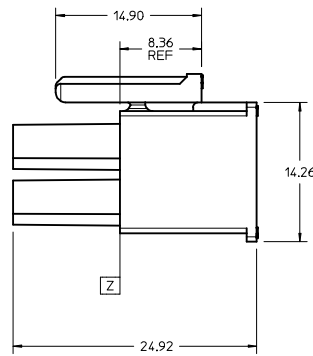

NOTES:

- MATERIAL:
HOUSING: PBT, UL 94V-0, COLOR: BLACK.
- FINISH: NOT APPLICABLE.
- PRODUCT SPECIFICATION: PS-76823-100.
- PACKAGING: BULK PACK PER PK-170001-001
- PART MATES WITH MOLEX SERIES NUMBERS 76825, 76829, 172064, AND 172065.
- PART IS FOR USE WITH MOLEX FEMALE TERMINAL 76823 OR 172063 SERIES.
- APPLICATION SPECIFICATION: AS-76823-100.
- PARTS CONFORM TO CLASS B REQUIREMENTS OF COSMETIC SPECIFICATION PS-45499-002 WITH THE EXCEPTION OF DISCOLORATION MEETS CLASS "C" REQUIREMENTS.

REVISE RIBS EC NO: UCP2015-2016 DRAWN: BELL 2015/01/09 CHKD: BELL 2015/01/09 APPR: F SMITH 2015/03/10	QUALITY SYMBOLS ▽=0 ▽=0 ▽=0	GENERAL TOLERANCES (UNLESS SPECIFIED)		DIMENSION STYLE MM ONLY		SCALE 4:1	DESIGN UNITS METRIC	THIRD ANGLE PROJECTION
		mm	INCH	DRAWN BY MKARADIMAS	DATE 2012/08/01	TITLE MEGA-FIT RECEPTACLE HOUSING 2-12 CKT		
		4 PLACES	±---	±---				
		3 PLACES	±---	±---				
		2 PLACES	±0.25	±---				
		1 PLACE	±---	±---				
		0 PLACE	±---	±---				
		ANGULAR ±1/2°		SEE CHART		MATERIAL NO. SD-171692-0100	DOCUMENT NO.	SHEET NO. 1 OF 2
DRAFT WHERE APPLICABLE MUST REMAIN WITHIN DIMENSIONS								
THIS DRAWING CONTAINS INFORMATION THAT IS PROPRIETARY TO MOLEX INCORPORATED AND SHOULD NOT BE USED WITHOUT WRITTEN PERMISSION								

20 19 18 17 16 15 14 13 12 11 10 9 8 7 6 5 4 3 2 1

2 CKTS

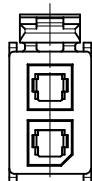

4 CKT

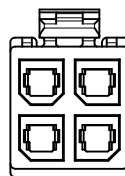

6 CKT

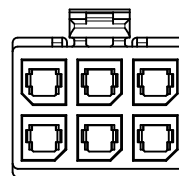

8 CKT

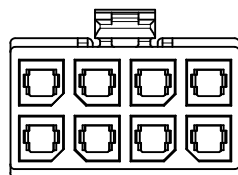

10 CKTS

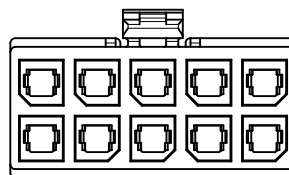

12 CKTS

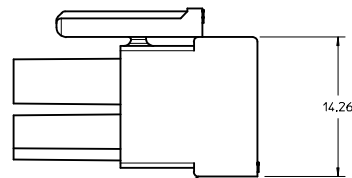
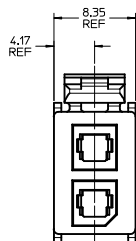
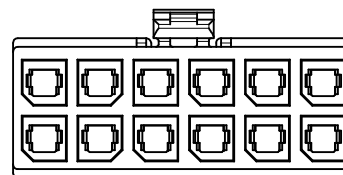

BOTTOM RIB ON
2 CKT ONLY

171692-0102

SEE SHT 1 IEC NO: UCP2015-2016 DRAWN: J.BELL 2015/01/09 CHECKED: J.BELL 2015/01/09 APPROVED: F.S.M.T.H. 2015/03/10	QUALITY SYMBOLS	GENERAL TOLERANCES (UNLESS SPECIFIED)	DIMENSION STYLE	SCALE	DESIGN UNITS	THIRD ANGLE PROJECTION
	▽=0	mm INCH	MM ONLY	4:1	METRIC	
	▽=0	4 PLACES ± --- ± ---	DRAWN BY	DATE	TITLE	
	▽=0	3 PLACES ± --- ± ---	MYKARADIMAS	2012/08/01	MEGA-FIT RECEPTACLE HOUSING 2-12 CKT	
	2 PLACES ± 0.25 ± ---	CHECKED BY	DATE			
	1 PLACE ± --- ± ---	APPROVED BY	DATE			
	0 PLACE ± --- ± ---	APATEL	2012/08/17			
	ANGULAR ±1/2°	MATERIAL NO.	SEE CHART	DOCUMENT NO.	SHEET NO.	
	DRAFT WHERE APPLICABLE MUST REMAIN WITHIN DIMENSIONS	SIZE	D THIS DRAWING CONTAINS INFORMATION THAT IS PROPRIETARY TO MOLEX INCORPORATED AND SHOULD NOT BE USED WITHOUT WRITTEN PERMISSION	SD-171692-0100	2 OF 2	

19 18 17 16 15 14 13 12 11 10 9 8 7 6 5 4 3 2 1