

TOSHIBA Photo-interrupter Infrared LED + Phototransistor

TLP1243(C8)

Copiers, Printers and Fax Machines

Air-conditioners

Game Machines

The TLP1243 (C8) is a compact photointerrupter with a built-in connector that uses a GaAs infrared LED and an Si phototransistor.

- Small package
Compared to Toshiba's TLP1241 (C5), the volume and the mounting area of the TLP1243 (C8) are reduced to approximately 70% and 75% respectively.
- Three board thicknesses supported: 1.0 mm, 1.2 mm and 1.6 mm
- Gap: 5 mm
- Resolution: Slit width = 0.7 mm
- High-temperature operation: $T_{opr} = 95^{\circ}\text{C}$ (max)
- Current transfer ratio: $I_C/I_F = 2.5\%$ (min)
- Mini CT connector (1.5-mm pitch, receptacle assembly/housing crimp type) made by Tyco Electronics AMP, Ltd.
- Package and connector material: Polycarbonate (UL94V-2)

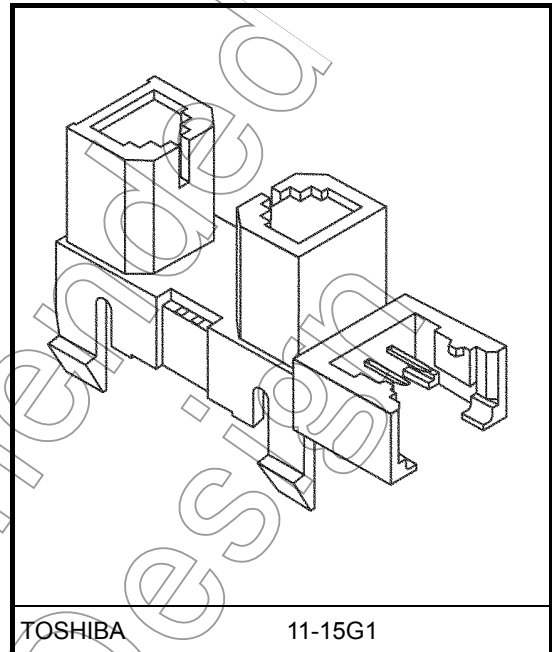

Weight: 0.8 g (typ.)

Marking

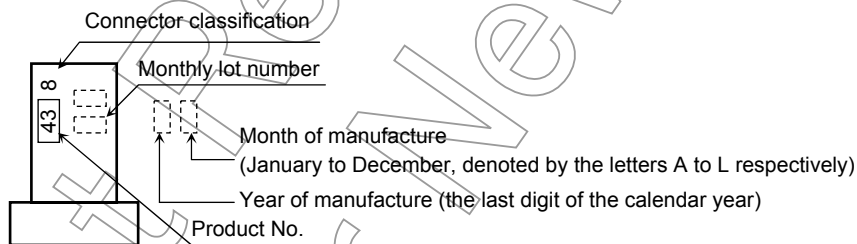

Absolute Maximum Ratings (Ta = 25°C)

Characteristics		Symbol	Rating	Unit
LED	Forward current	I_F	30	mA
	Forward current derating (Ta>25°C)	$\Delta I_F/^\circ\text{C}$	-0.28	mA/°C
	Reverse voltage	V_R	5	V
Detector	Collector-emitter voltage	V_{CEO}	35	V
	Emitter-collector voltage	V_{ECO}	5	V
	Collector power dissipation	P_C	75	mW
	Collector power dissipation derating (Ta>25°C)	$\Delta P_C/^\circ\text{C}$	-1	mW/°C
	Collector current	I_C	50	mA
Operating temperature range		T_{opr}	-30 to 95	°C
Storage temperature range		T_{stg}	-40 to 100	°C

Note: Using continuously under heavy loads (e.g. the application of high temperature/current/voltage and the significant change in temperature, etc.) may cause this product to decrease in the reliability significantly even if the operating conditions (i.e. operating temperature/current/voltage, etc.) are within the absolute maximum ratings.

Please design the appropriate reliability upon reviewing the Toshiba Semiconductor Reliability Handbook ("Handling Precautions"/"Derating Concept and Methods") and individual reliability data (i.e. reliability test report and estimated failure rate, etc).

Optical and Electrical Characteristics (Ta = 25°C)

Characteristics		Symbol	Test conditions	Min	Typ.	Max	Unit
LED	Forward voltage	V_F	$I_F = 10 \text{ mA}$	1.00	1.18	1.40	V
	Reverse current	I_R	$V_R = 5 \text{ V}$	—	—	10	μA
	Peak emission wavelength	λ_P	$I_F = 10 \text{ mA}$	—	940	—	nm
Detector	Dark current	$I_D (I_{CEO})$	$V_{CE} = 24 \text{ V}, I_F = 0$	—	0.001	0.1	μA
	Peak sensitivity wavelength	λ_P	—	—	870	—	nm
Coupled	Current transfer ratio	I_C/I_F	$V_{CE} \geq 2 \text{ V}, I_F = 10 \text{ mA}$	2.5	—	100	%
	Collector-emitter saturation voltage	$V_{CE}(\text{sat})$	$I_F = 20 \text{ mA}, I_C = 0.25 \text{ mA}$	—	0.1	0.35	V
	Rise time	t_r	$V_{CE} = 5 \text{ V}, I_C = 1 \text{ mA}, R_L = 1 \text{ k}\Omega$	—	15	50	μs
	Fall time	t_f		—	15	50	

Recommended Connector

Mini CT connector (1.5-mm pitch, receptacle assembly/housing crimp type) made by Tyco Electronics AMP, Ltd.

Housing-Terminal En Block Type	Type	Model Number	Terminal Material	AWG Size	External Diameter of Insulation Coating
	Receptacle assembly	353293-3	Phosphor bronze	AWG26 to 28	0.85 mm to 0.95 mm
	Housing crimp type	353908-3			

Note: For further details of connector characteristics, please contact the relevant connector manufacturer.

Precautions

- Protect the device from ambient light interference. The integrated phototransistor is insensitive to light below 700 nm (e.g., fluorescent light), but is sensitive to light above 700 nm (e.g., incandescent light). If it detects ambient light, it may cause malfunction. Be sure to make a thorough evaluation of the equipment in which the device is to be used.
- Care must be taken regarding the environment in which the device is to be installed. Oil or chemicals may cause the package to melt or crack.
- When attaching the device to the metal board, always hold the body of the device. Do not hold the device by the connector. Ensure that the board is flat, and not warped or twisted. Attach the device to the metal board at room temperature.
- Toshiba recommends attaching the device to the smoother side of the board.
- Toshiba recommends testing the attachment strength beforehand by actually attaching a device to the board.
- Do not apply solder to the pins of the device's connector. Make sure that the connector is plugged into the Mini CT connector or equivalent connector.
- When inserting or removing the Mini CT connector or equivalent connector, always grasp it and its cable firmly and either plug it straight into or pull it straight out of the device's connector. If the Mini CT connector or equivalent connector is inserted or removed at an angle, both the device's connector and the Mini CT connector or equivalent connector may get damaged, resulting in an unreliable connection.
- Conversion efficiency decreases over time due to current flow in the infrared LED. When designing a circuit, take into account this change in conversion efficiency over time. The ratio of fluctuation in conversion efficiency to fluctuation in infrared LED optical output is 1:1:

$$\frac{IC/IF(t)}{IC/IF(0)} = \frac{P_o(t)}{P_o(0)}$$

- The leadframe of the package is exposed as shown below. Ensure that no conductive material or object (such as a metal pin) comes into contact with the leads of the leadframe and shorts them together. Care must be taken when designing a chassis.

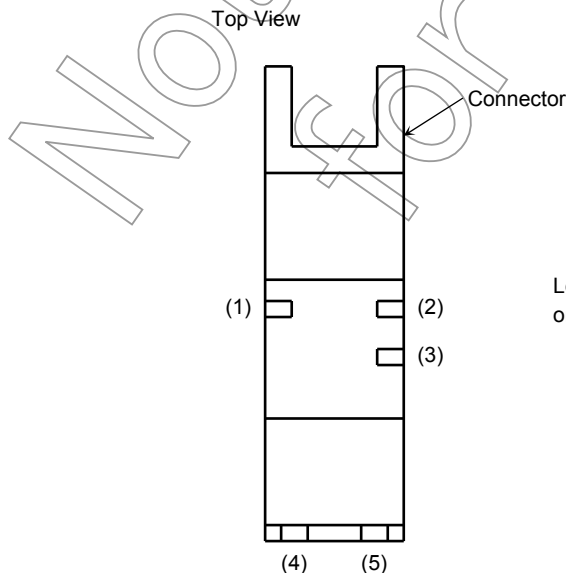

Leads (1) to (5) of the leadframe shown on the left must not be shorted together.

Package Dimensions:

Unit: mm

TOSHIBA 11-15G1

Tolerances are listed below unless otherwise specified.

Dimensions	Tolerance
6 mm or less	±0.1
Greater than 6 mm	±0.2

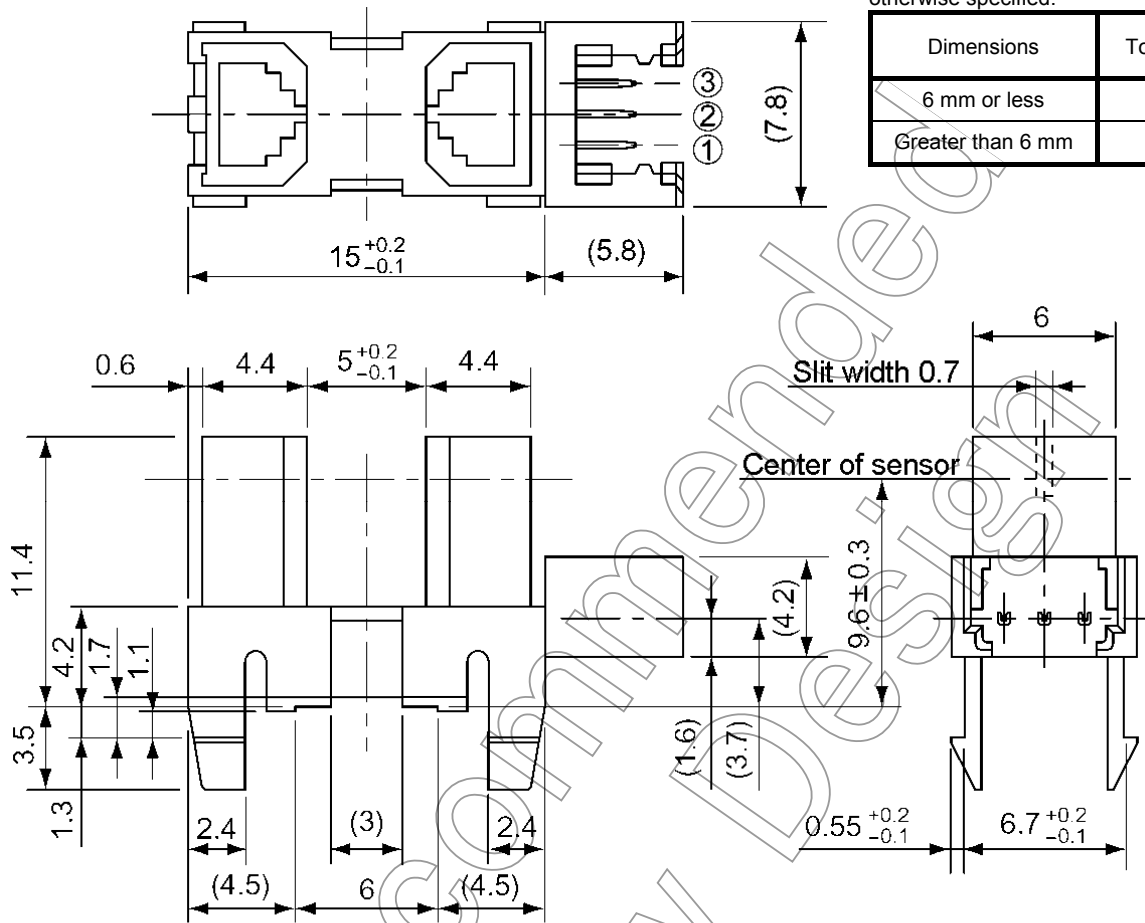

(): Reference value

Weight: 0.8 g (typ.)

Pin Connection

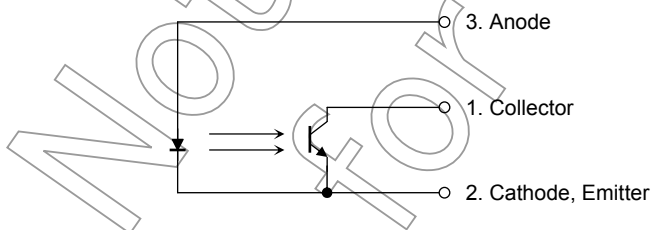

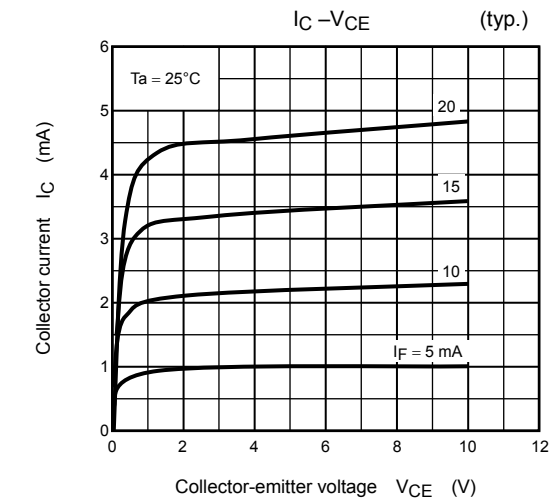
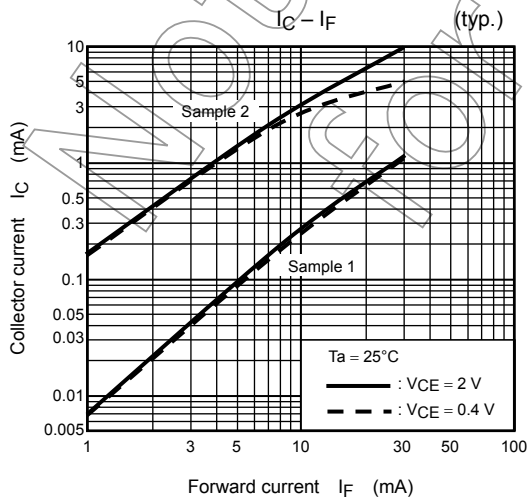
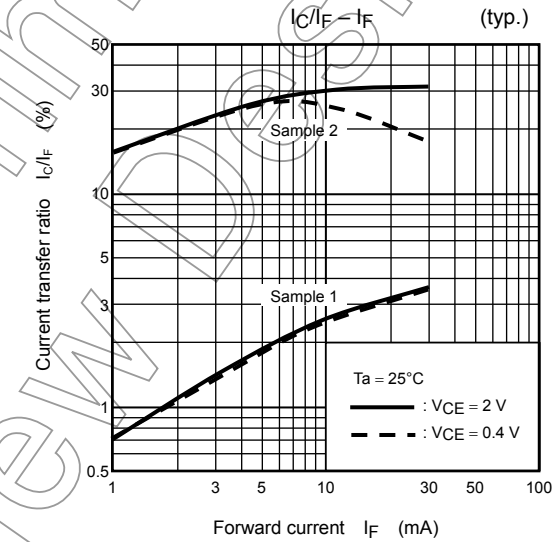
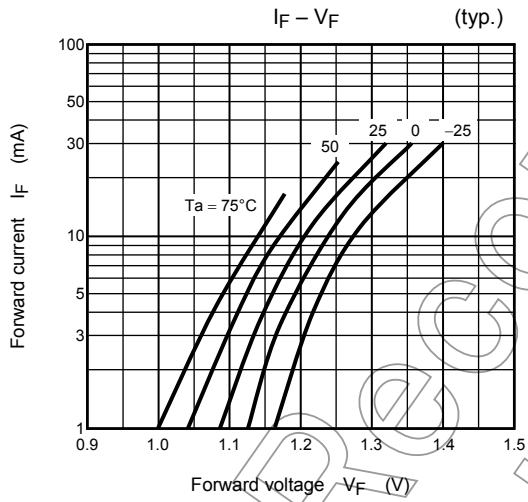
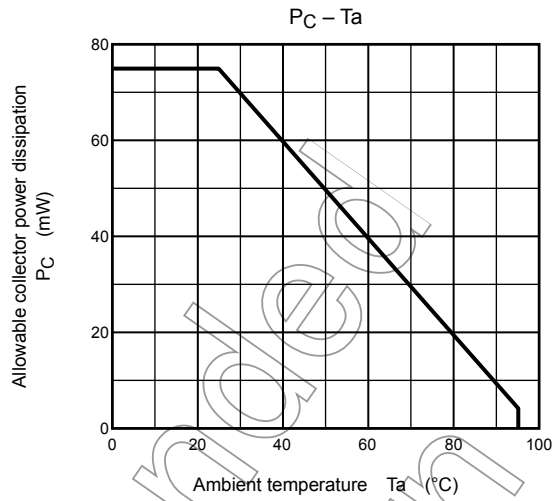
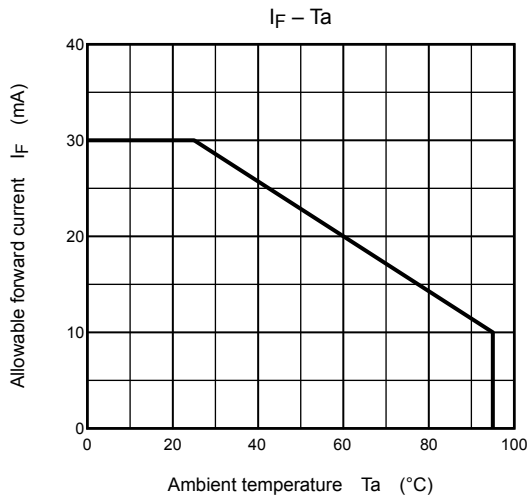

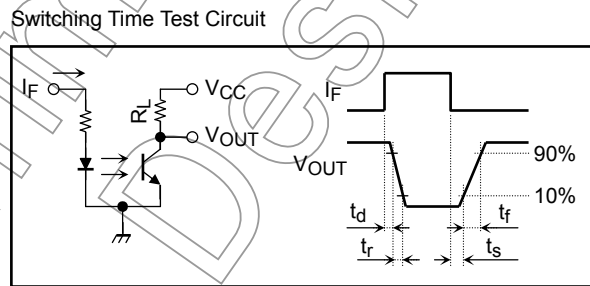
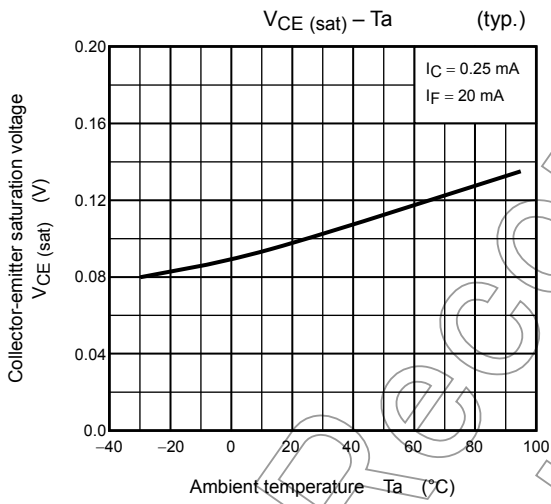
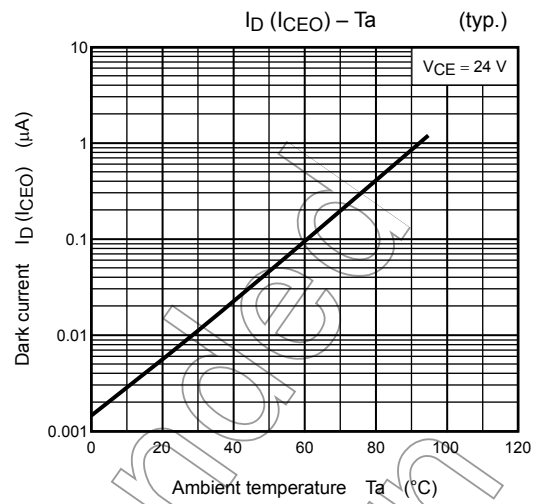
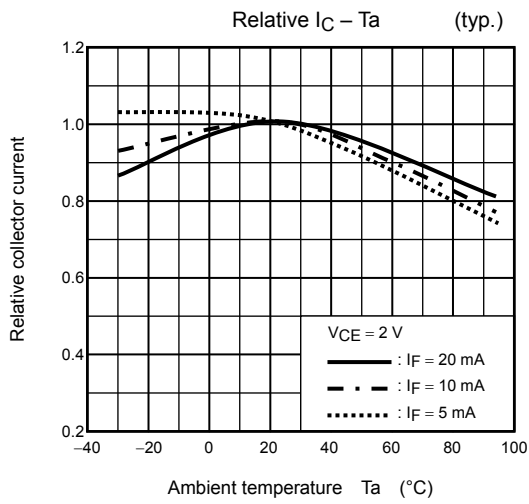

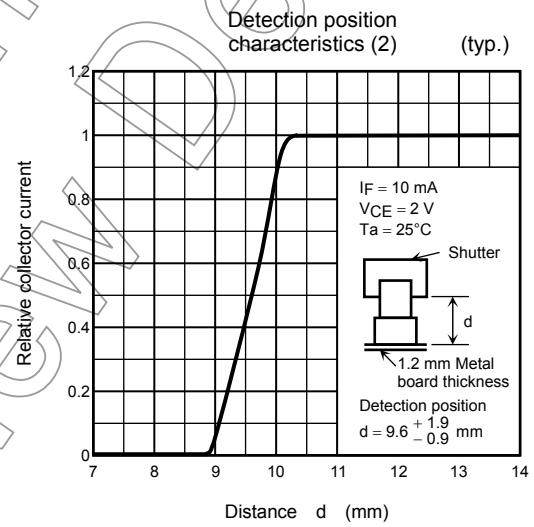
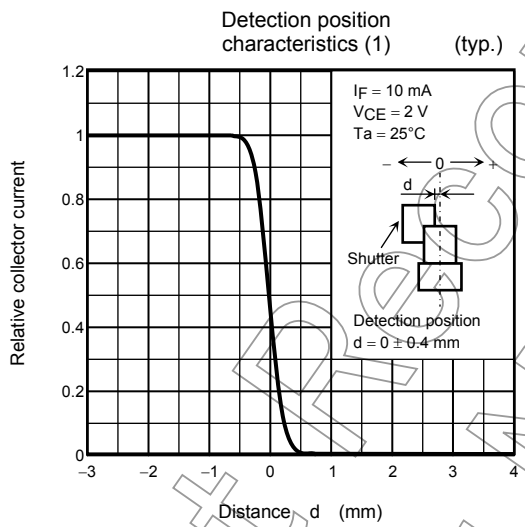
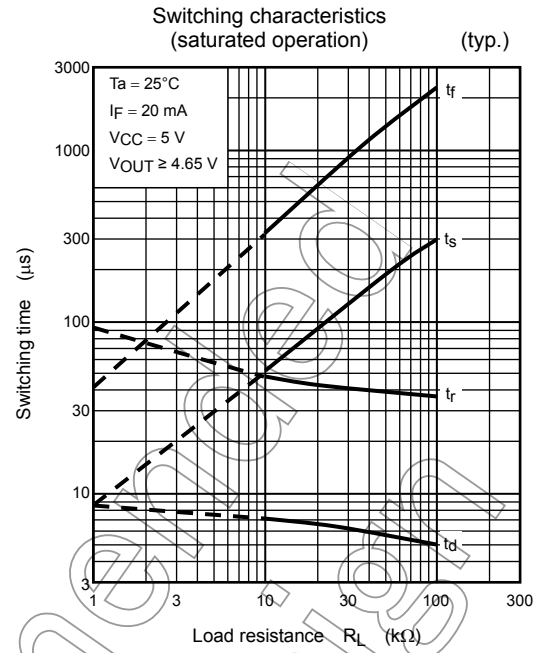
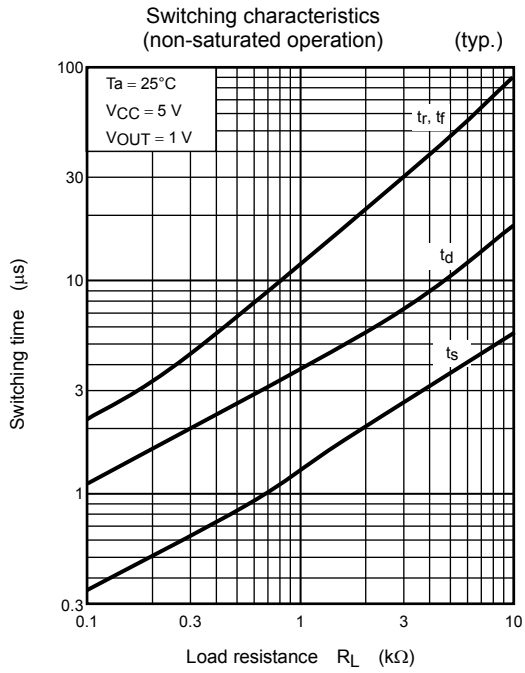

Relative Positioning of Shutter and Device

For normal operation, position the shutter and the device as shown in the figure below. By considering the device's detection direction characteristic and switching time, determine the shutter slit width and pitch.

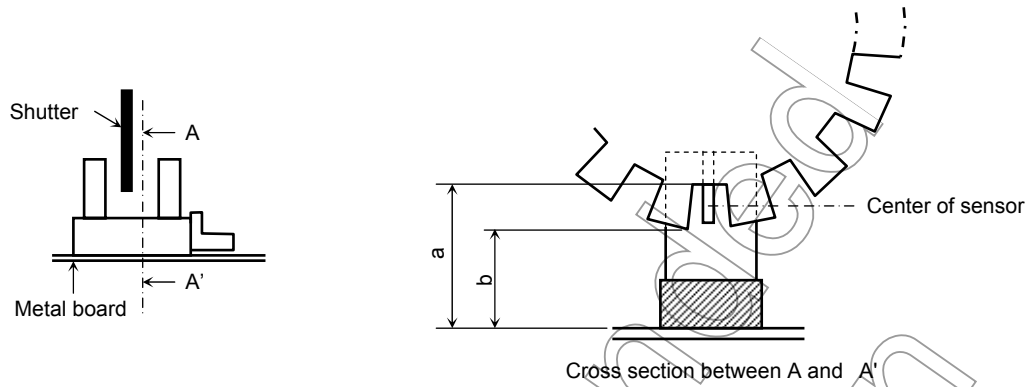

Unit: mm

Thickness of Metal Board	a Dimension	b Dimension
1.0	11.7 min	8.9 max
1.2	11.5 min	8.7 max
1.6	11.1 min	8.3 max

Recommended Size of Connection Holes (Unit: mm)

1.0-mm thick metal board

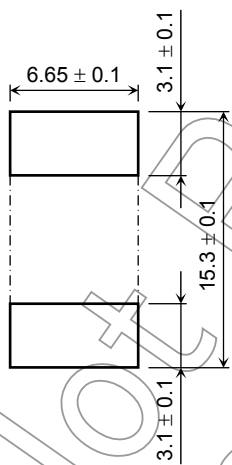

1.2-mm thick metal board

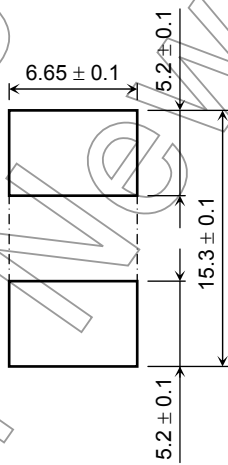

1.6-mm thick metal board

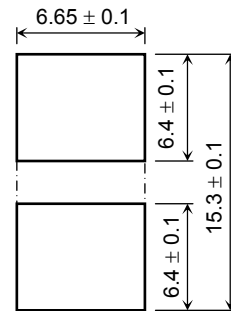

RESTRICTIONS ON PRODUCT USE

- Toshiba Corporation, and its subsidiaries and affiliates (collectively "TOSHIBA"), reserve the right to make changes to the information in this document, and related hardware, software and systems (collectively "Product") without notice.
- This document and any information herein may not be reproduced without prior written permission from TOSHIBA. Even with TOSHIBA's written permission, reproduction is permissible only if reproduction is without alteration/omission.
- Though TOSHIBA works continually to improve Product's quality and reliability, Product can malfunction or fail. Customers are responsible for complying with safety standards and for providing adequate designs and safeguards for their hardware, software and systems which minimize risk and avoid situations in which a malfunction or failure of Product could cause loss of human life, bodily injury or damage to property, including data loss or corruption. Before creating and producing designs and using, customers must also refer to and comply with (a) the latest versions of all relevant TOSHIBA information, including without limitation, this document, the specifications, the data sheets and application notes for Product and the precautions and conditions set forth in the "TOSHIBA Semiconductor Reliability Handbook" and (b) the instructions for the application that Product will be used with or for. Customers are solely responsible for all aspects of their own product design or applications, including but not limited to (a) determining the appropriateness of the use of this Product in such design or applications; (b) evaluating and determining the applicability of any information contained in this document, or in charts, diagrams, programs, algorithms, sample application circuits, or any other referenced documents; and (c) validating all operating parameters for such designs and applications. **TOSHIBA ASSUMES NO LIABILITY FOR CUSTOMERS' PRODUCT DESIGN OR APPLICATIONS.**
- Product is intended for use in general electronics applications (e.g., computers, personal equipment, office equipment, measuring equipment, industrial robots and home electronics appliances) or for specific applications as expressly stated in this document. Product is neither intended nor warranted for use in equipment or systems that require extraordinarily high levels of quality and/or reliability and/or a malfunction or failure of which may cause loss of human life, bodily injury, serious property damage or serious public impact ("Unintended Use"). Unintended Use includes, without limitation, equipment used in nuclear facilities, equipment used in the aerospace industry, medical equipment, equipment used for automobiles, trains, ships and other transportation, traffic signaling equipment, equipment used to control combustions or explosions, safety devices, elevators and escalators, devices related to electric power, and equipment used in finance-related fields. Do not use Product for Unintended Use unless specifically permitted in this document.
- Do not disassemble, analyze, reverse-engineer, alter, modify, translate or copy Product, whether in whole or in part.
- Product shall not be used for or incorporated into any products or systems whose manufacture, use, or sale is prohibited under any applicable laws or regulations.
- The information contained herein is presented only as guidance for Product use. No responsibility is assumed by TOSHIBA for any infringement of patents or any other intellectual property rights of third parties that may result from the use of Product. No license to any intellectual property right is granted by this document, whether express or implied, by estoppel or otherwise.
- **ABSENT A WRITTEN SIGNED AGREEMENT, EXCEPT AS PROVIDED IN THE RELEVANT TERMS AND CONDITIONS OF SALE FOR PRODUCT, AND TO THE MAXIMUM EXTENT ALLOWABLE BY LAW, TOSHIBA (1) ASSUMES NO LIABILITY WHATSOEVER, INCLUDING WITHOUT LIMITATION, INDIRECT, CONSEQUENTIAL, SPECIAL, OR INCIDENTAL DAMAGES OR LOSS, INCLUDING WITHOUT LIMITATION, LOSS OF PROFITS, LOSS OF OPPORTUNITIES, BUSINESS INTERRUPTION AND LOSS OF DATA, AND (2) DISCLAIMS ANY AND ALL EXPRESS OR IMPLIED WARRANTIES AND CONDITIONS RELATED TO SALE, USE OF PRODUCT, OR INFORMATION, INCLUDING WARRANTIES OR CONDITIONS OF MERCHANTABILITY, FITNESS FOR A PARTICULAR PURPOSE, ACCURACY OF INFORMATION, OR NONINFRINGEMENT.**
- GaAs (Gallium Arsenide) is used in Product. GaAs is harmful to humans if consumed or absorbed, whether in the form of dust or vapor. Handle with care and do not break, cut, crush, grind, dissolve chemically or otherwise expose GaAs in Product.
- Do not use or otherwise make available Product or related software or technology for any military purposes, including without limitation, for the design, development, use, stockpiling or manufacturing of nuclear, chemical, or biological weapons or missile technology products (mass destruction weapons). Product and related software and technology may be controlled under the Japanese Foreign Exchange and Foreign Trade Law and the U.S. Export Administration Regulations. Export and re-export of Product or related software or technology are strictly prohibited except in compliance with all applicable export laws and regulations.
- Please contact your TOSHIBA sales representative for details as to environmental matters such as the RoHS compatibility of Product. Please use Product in compliance with all applicable laws and regulations that regulate the inclusion or use of controlled substances, including without limitation, the EU RoHS Directive. TOSHIBA assumes no liability for damages or losses occurring as a result of noncompliance with applicable laws and regulations.