

2W Detector Switches

Type: **ESE24**

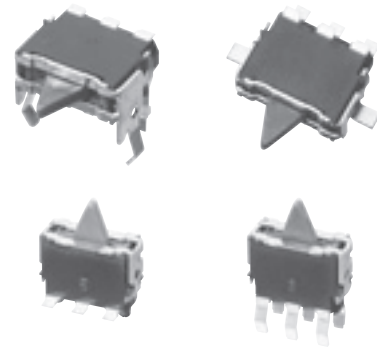

Bidirectional operation, midpoint auto-return Type

■ Features

- A lever-type detector switch with high reliability using sliding mechanical contacts
- Long over-travel (through-operation available)
- Used as an operation switch (an input device)

■ Recommended Applications

- Detection of media in portable electronic equipment (CD-ROM, DVD, Digital still cameras, etc.)
- Operating switches for other electronic equipment.

■ Explanation of Part Number

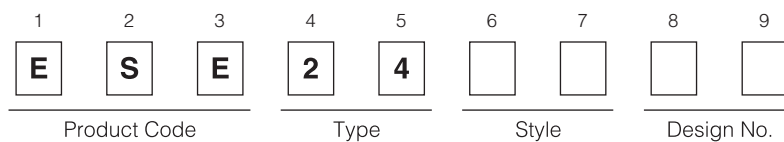

6th & 7th	Mounting Method & Style
SV	Vertical type for wave soldering
SH	Horizontal type for wave soldering
MV	Vertical type for reflow soldering
MH	Horizontal type for reflow soldering

■ Specifications

Rating	50 μ A 3 V DC to 10 mA 5 V DC (Resistive load)	
Contact Resistance	500 m Ω max. (Initial)	
Insulation Resistance	100 M Ω min. (100 V DC)	
Dielectric Withstanding Voltage	100 V AC for 1 minute	
Operating Force	350 mN max.	
Mounting Height	<ul style="list-style-type: none"> · Type SV 5.6 mm · Type SH 4.65 mm · Type MV 5.6 mm · Type MH 3.0 mm 	
Poles and Throws	1-pole 2-throws (OFF at midpoint)	
Full Travel (Pushing distance)	<ul style="list-style-type: none"> · Type SV 6.1 mm (2.45 mm) · Type SH 2.6 mm (2.45 mm) · Type MV 6.1 mm (2.45 mm) · Type MH 1.4 mm (2.45 mm) 	
Operating Life	50,000 cycles min.	
Temperature Range	-10 °C to +70 °C	
Heat Resistance	+80 °C for 96 hours	
Low Temperature Resistance	-25 °C for 96 hours	
Humidity Resistance	+40 °C 90 % to 95 % RH for 96 hours	
Minimum Quantity/Packing Unit	ESE24MH, MV, SV, SH	200 pcs. Polyethylene Bag (Bulk) ^{*1}
	ESE24MH□T	1,000 pcs. Embossed Taping (Reel Pack) ^{*2}
	ESE24MV□T	500 pcs. Embossed Taping (Reel Pack)
Quantity/Carton	ESE24MH, MV, SV, SH	10,000 pcs. Polyethylene Bag (Bulk)
	ESE24MH□T	6,000 pcs. Embossed Taping (Reel Pack)
	ESE24MV□T	3,000 pcs. Embossed Taping (Reel Pack)

^{*1} ESE24SH type: 160 pcs. (Polyethylene Bag), 8,000 pcs. (Reel Pack)
^{*2} ESE24SV, ESE24SH are excluded

Design and specifications are each subject to change without notice. Ask factory for the current technical specifications before purchase and/or use.
 Should a safety concern arise regarding this product, please be sure to contact us immediately.

■ Dimensions in mm (not to scale)

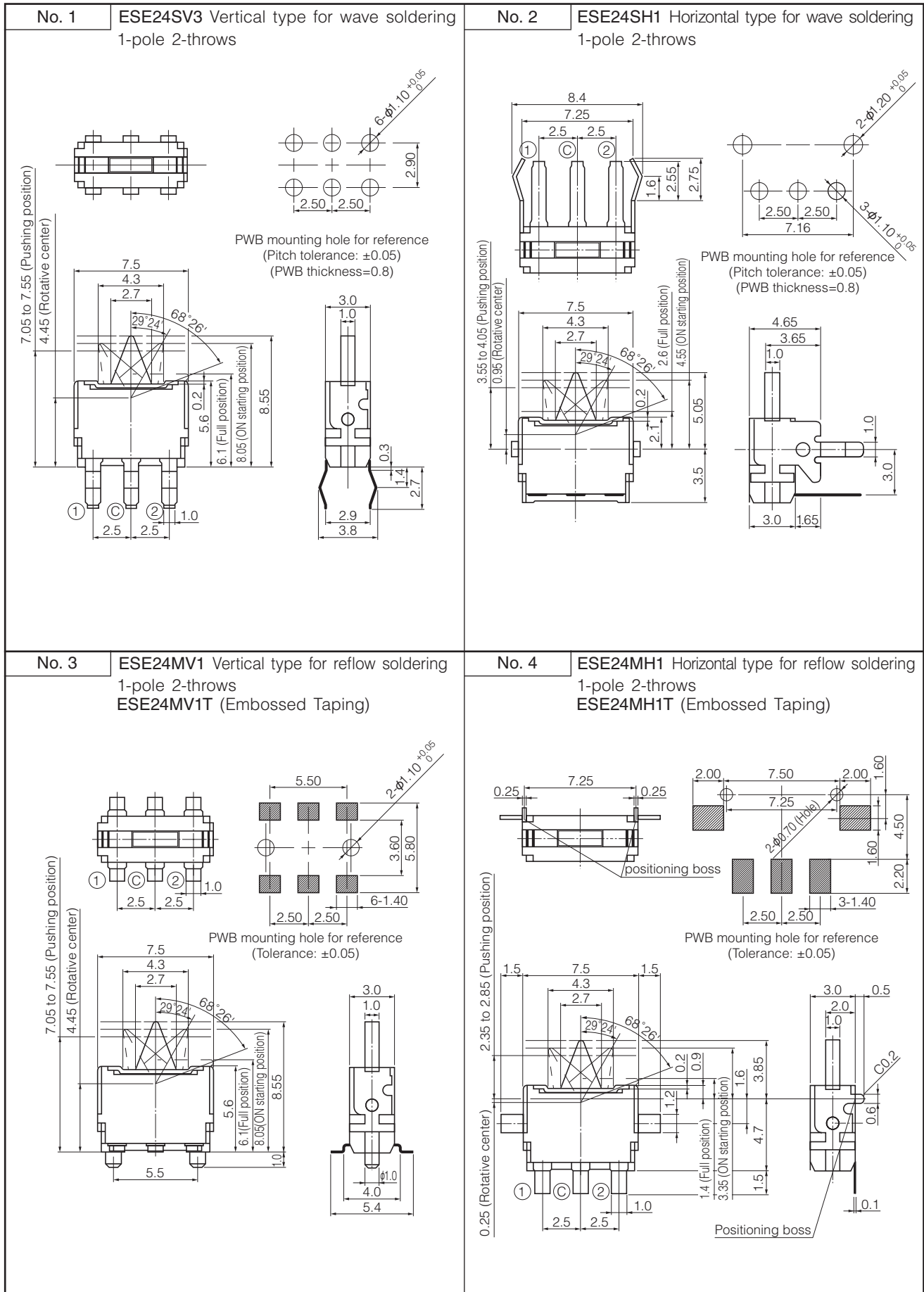

Design and specifications are each subject to change without notice. Ask factory for the current technical specifications before purchase and/or use.
Should a safety concern arise regarding this product, please be sure to contact us immediately.

■ Circuit Diagram

1-pole 2-throws (N . O)

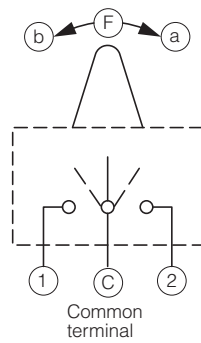

Terminal No. Lever position	1	c	2
F		○	
a	○	○	
b		○	○

■ Packaging Specifications

Standard Reel Dimensions in mm (not to scale)

Taping Reel

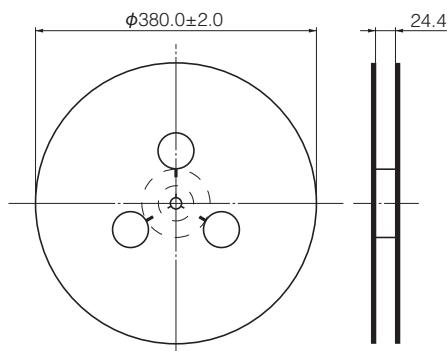

Embossed Carrier Taping

ESE24MH□T

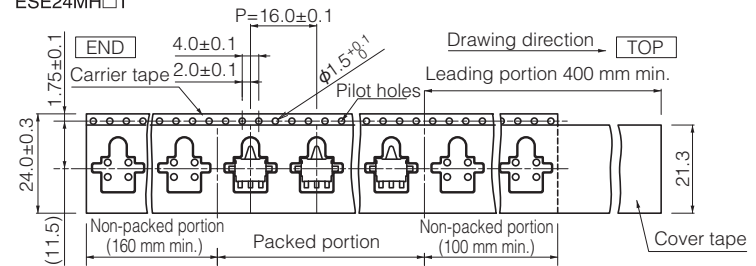

ESE24MV□T

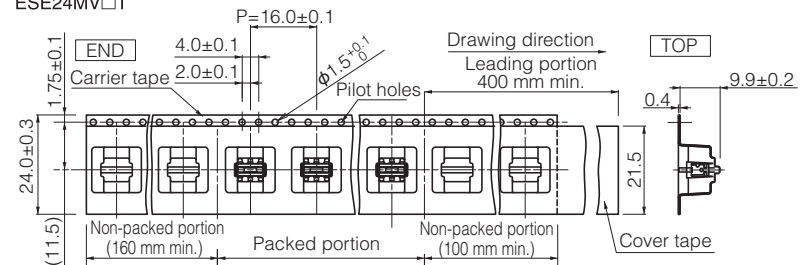

Design and specifications are each subject to change without notice. Ask factory for the current technical specifications before purchase and/or use. Should a safety concern arise regarding this product, please be sure to contact us immediately.