

SMT GaAs HBT MMIC x8 ACTIVE FREQUENCY MULTIPLIER, 9.9 - 11.2 GHz OUTPUT



Typical Applications

Active Multiplier for X Band Applications:

- Fiber Optic
- Point-to-Point Radios
- Military Radar

Features

- Output Power: +6 dBm
- Sub-Harmonic Suppression: >25 dBc
- SSB Phase Noise: -136 dBc/Hz
- Single Supply: +5V@ 68 mA
- 24 Lead 4x4 mm SMT Package: 16 mm²

Functional Diagram

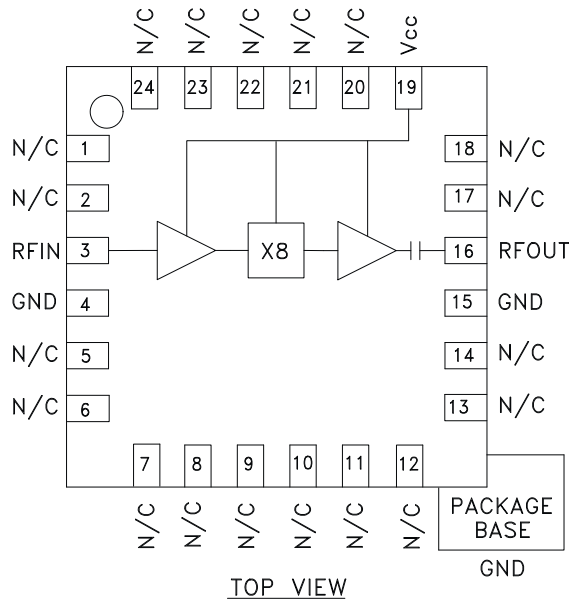

General Description

The HMC444LP4 & HMC444LP4E are active miniature x8 frequency multipliers utilizing InGaP GaAs HBT technology in 4x4 mm leadless surface mount packages. Power output is +6 dBm typical from a 5V supply voltage and varies little vs. input power, temperature and supply voltage. Suppression of undesired fundamental and sub-harmonics is >25 dBc typical with respect to output signal level. The low additive SSB phase noise of -136 dBc/Hz at 100 kHz offset helps the user maintain good system noise performance. The HMC444LP4 & HMC444LP4E are ideal for use in LO multiplier chains allowing reduced parts count vs. traditional approaches.

Electrical Specifications, $T_A = +25^\circ\text{C}$, $V_{CC} = 5\text{V}$

Parameter	Min.	Typ.	Max.	Units
Frequency Range, Input	1.2375 - 1.40			GHz
Frequency Range, Output	9.9 - 11.2			GHz
Input Power Range	-15		+5	dBm
Output Power	3	6		dBm
Sub-Harmonic Suppression		25		dBc
Input Return Loss		22		dB
Output Return Loss		7		dB
SSB Phase Noise (100 kHz Offset)	Pin= 0 dBm		-136	dBc/Hz
Supply Current (I _{CC})		68	91	mA

HMC444* PRODUCT PAGE QUICK LINKS

Last Content Update: 02/23/2017

COMPARABLE PARTS

View a parametric search of comparable parts.

EVALUATION KITS

- HMC444LP4 Evaluation Board

DOCUMENTATION

Data Sheet

- HMC444 Data Sheet

TOOLS AND SIMULATIONS

- HMC444 S-Parameter

REFERENCE MATERIALS

Quality Documentation

- Package/Assembly Qualification Test Report: LP4, LP4B, LP4C, LP4K (QTR: 2013-00487 REV: 04)
- Package/Assembly Qualification Test Report: Plastic Encapsulated QFN (QTR: 05006 REV: 02)
- Semiconductor Qualification Test Report: GaAs HBT-A (QTR: 2013-00228)

Technical Articles

- Active Multipliers & Dividers to Simplify Synthesizers

DESIGN RESOURCES

- HMC444 Material Declaration
- PCN-PDN Information
- Quality And Reliability
- Symbols and Footprints

DISCUSSIONS

View all HMC444 EngineerZone Discussions.

SAMPLE AND BUY

Visit the product page to see pricing options.

TECHNICAL SUPPORT

Submit a technical question or find your regional support number.

DOCUMENT FEEDBACK

Submit feedback for this data sheet.

SMT GaAs HBT MMIC x8 ACTIVE FREQUENCY MULTIPLIER, 9.9 - 11.2 GHz OUTPUT



Output Power vs. Temperature @ -10 dBm Drive Level

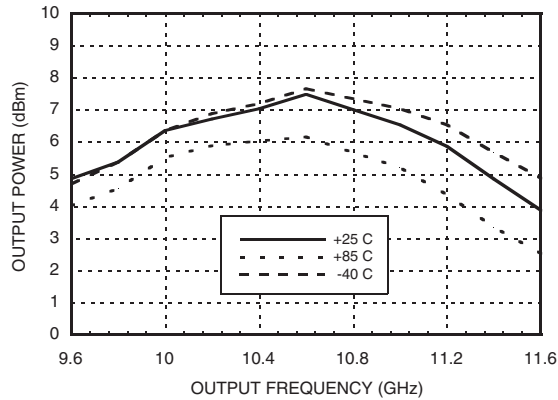

Output Power vs. Drive Level

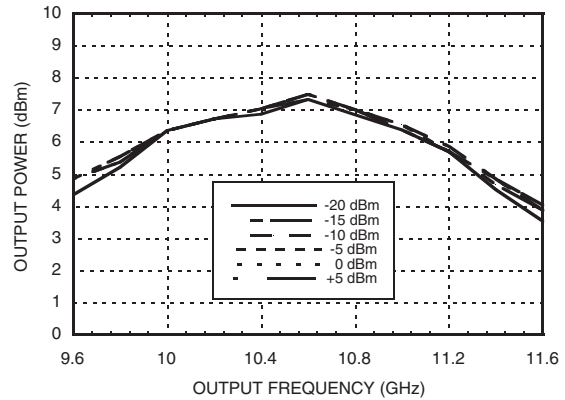

Output Power vs. Supply Voltage @ -10 dBm Drive Level

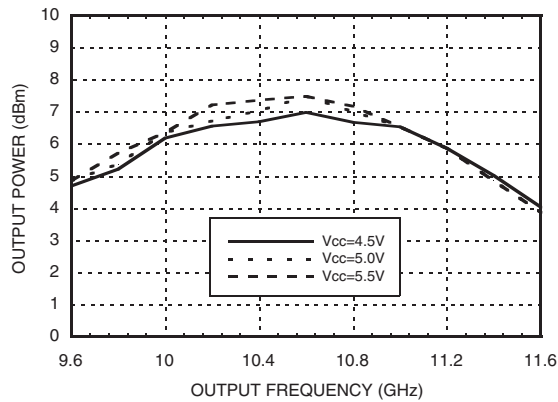

Input Return Loss vs. Temperature

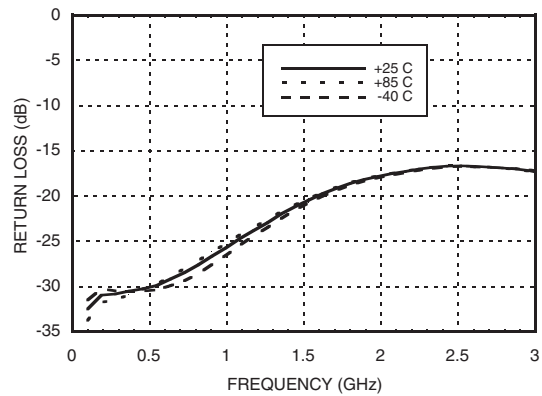

Output Return Loss vs. Temperature

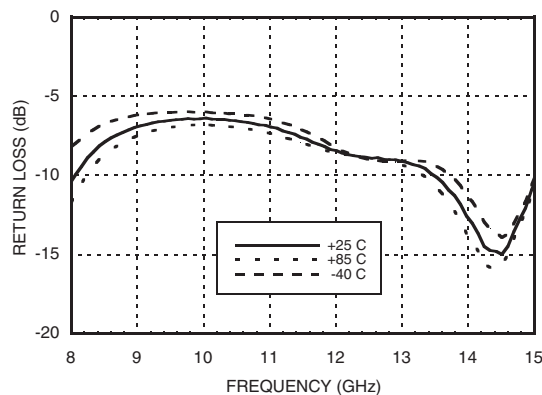

Information furnished by Analog Devices is believed to be accurate and reliable. However, no responsibility is assumed by Analog Devices for its use, nor for any infringements of patents or other rights of third parties that may result from its use. Specifications subject to change without notice. No license is granted by implication or otherwise under any patent or patent rights of Analog Devices. Trademarks and registered trademarks are the property of their respective owners.

For price, delivery, and to place orders: Analog Devices, Inc., One Technology Way, P.O. Box 9106, Norwood, MA 02062-9106 Phone: 781-329-4700 • Order online at www.analog.com Application Support: Phone: 1-800-ANALOG-D

**SMT GaAs HBT MMIC x8 ACTIVE
FREQUENCY MULTIPLIER, 9.9 - 11.2 GHz OUTPUT**



Output Spectrum

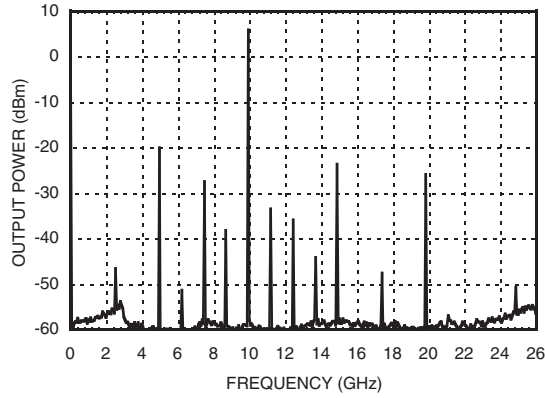

**SSB Phase Noise
Performance, $F_{out} = 10.5$ GHz**

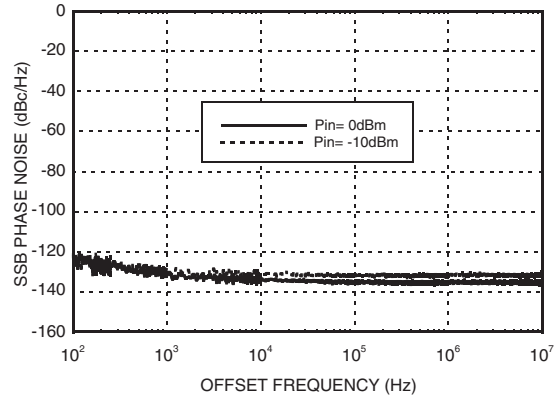

SMT GaAs HBT MMIC x8 ACTIVE FREQUENCY MULTIPLIER, 9.9 - 11.2 GHz OUTPUT



Absolute Maximum Ratings

RF Input (Vcc = +5V)	+20 dBm
Vcc	+5.5V
Channel Temperature	135 °C
Continuous Pdiss (T=85 °C) (derate 10 mW/°C above 85 °C)	650 mW
Thermal Resistance (R _{thj}) (junction to ground paddle)	100 °C/W
Storage Temperature	-65 to +150 °C
Operating Temperature	-40 to +85 °C

Typical Supply Current vs. Vcc

Vcc (V)	Icc (mA)
4.5	66
5.0	68
5.5	70

Note: Multiplier will operate over full voltage range shown above.



ELECTROSTATIC SENSITIVE DEVICE
OBSERVE HANDLING PRECAUTIONS

5

Outline Drawing

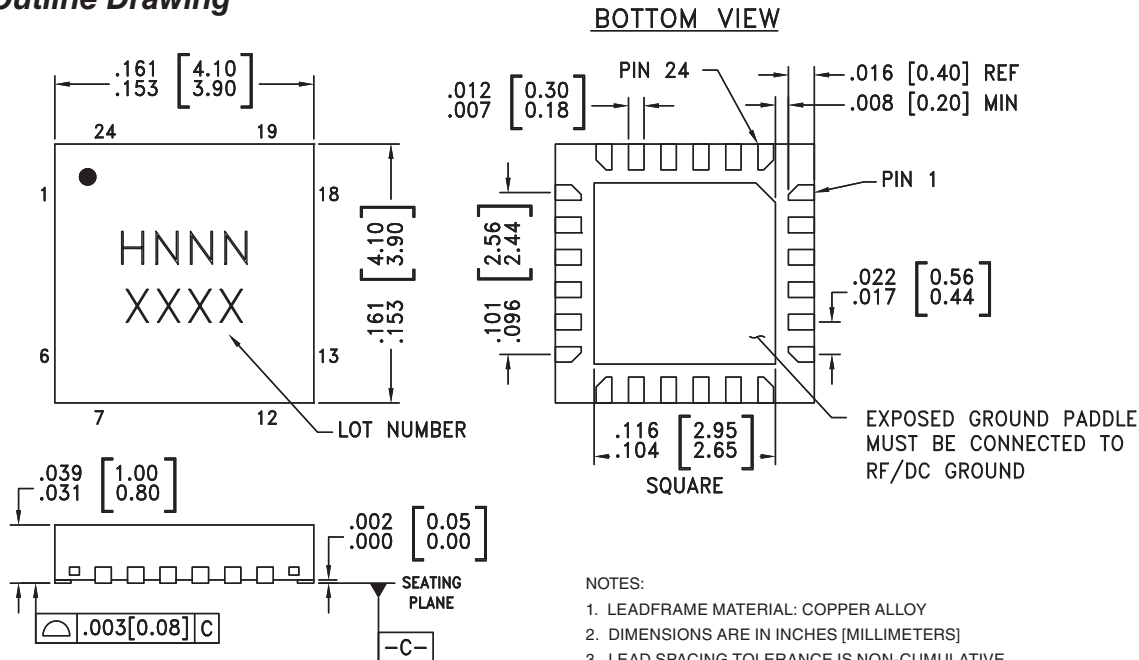

Package Information



Part Number	Package Body Material	Lead Finish	MSL Rating	Package Marking ^[3]
HMC444LP4	Low Stress Injection Molding Plastic	Sn/Pb Solder	MSL1 ^[1]	H444 XXXX
HMC444LP4E	RoHS-compliant Low Stress Injection Molding Plastic	100% matte Sn	MSL1 ^[2]	H444 XXXX

[1] Max peak reflow temperature of 235 °C

[2] Max peak reflow temperature of 260 °C

[3] 4-Digit lot number XXXX

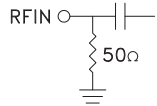

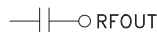
**SMT GaAs HBT MMIC x8 ACTIVE
FREQUENCY MULTIPLIER, 9.9 - 11.2 GHz OUTPUT**
Pin Description

Pin Number	Function	Description	Interface Schematic
1, 2, 5 - 14, 17, 18, 20 - 24	N/C	The pins are not connected internally; however, all data shown herein was measured with these pins connected to RF/DC ground externally.	
3	RFIN	RF input needs to be DC blocked only if there is an external DC voltage applied to RF IN.	
4, 15	GND	All ground leads and ground paddle must be soldered to PCB RF/DC ground.	
16	RFOUT	Multiplied Output. AC coupled. No external DC blocks necessary.	
19	Vcc	Supply voltage 5V ± 0.5V.	

SMT GaAs HBT MMIC x8 ACTIVE FREQUENCY MULTIPLIER, 9.9 - 11.2 GHz OUTPUT

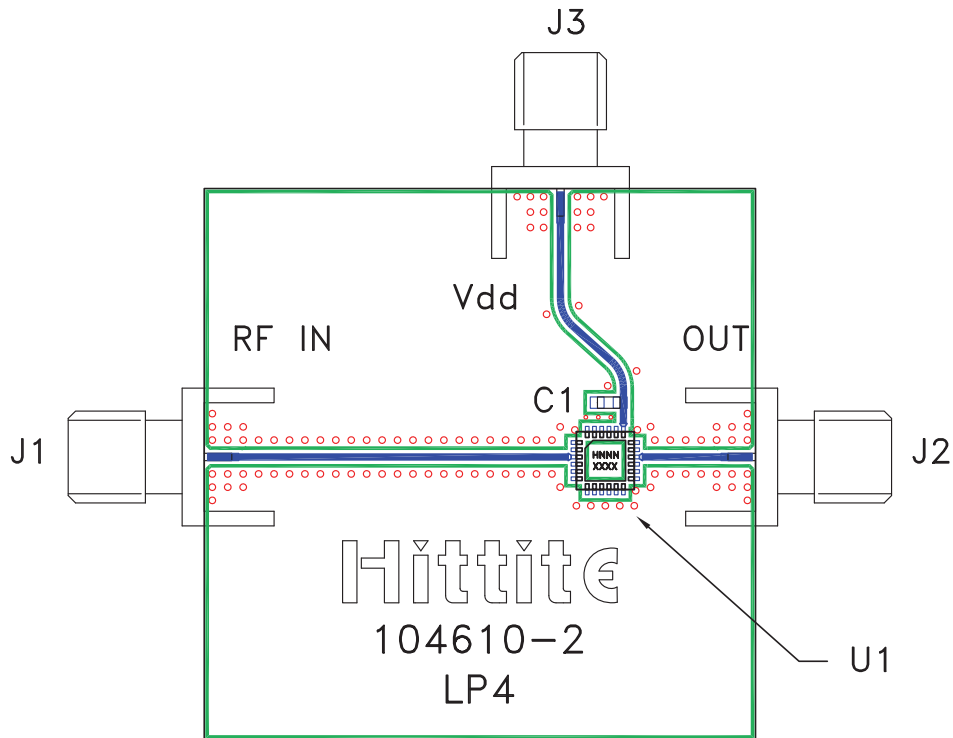

Evaluation PCB



List of Materials for Evaluation PCB 106137 [1]

Item	Description
J1 - J3	PCB Mount SMA Connector
C1	1,000 pF Capacitor, 0603 Pkg.
U1	HMC444LP4(E) x8 Active Multiplier
PCB [2]	104610 Eval Board

[1] Reference this number when ordering complete evaluation PCB

[2] Circuit Board Material: Rogers 4350

The circuit board used in the final application should be generated with proper RF circuit design techniques. Signal lines should have 50 ohm impedance while the package ground leads and exposed paddle should be connected directly to the ground plane similar to that shown. The evaluation circuit board shown is available from Hittite upon request.