

Evaluates: MAX14824

General Description

The MAX14824 evaluation kit (EV kit) consists of a MAX14824 evaluation board and software. The EV kit is a fully assembled and tested circuit board that evaluates the MAX14824 IO-Link™ master transceiver.

The EV kit includes Windows XP®, Windows Vista®, and Windows® 7-compatible software that provides a graphical user interface (GUI) for exercising the features of the device. The EV kit is connected to a PC through a USB A-to-B cable.

Features

- ◆ **IO-Link-Compliant Master Transceiver**
- ◆ **IO and SPI Interface Terminals**
- ◆ **Windows XP-, Windows Vista-, and Windows 7-Compatible Software**
- ◆ **USB-PC Connection (Cable Included)**
- ◆ **Proven PCB Layout**
- ◆ **Fully Assembled and Tested**

Ordering Information appears at end of data sheet.

Component List

DESIGNATION	QTY	DESCRIPTION
C1, C26	2	270pF ±5%, 50V C0G ceramic capacitors (0603) TDK C1608C0G1H271J
C2	1	1nF ±5%, 50V X7R ceramic capacitor (0603) KEMET C0603C102J5RACTU
C4	1	2.2µF ±10%, 50V X7R ceramic capacitor (1206) Murata GRM31CR71H225K
C5, C7, C8, C10, C15, C18–C24	12	0.1µF ±10%, 16V X5R ceramic capacitors (0603) Murata GRM188R61C104K
C6	1	1µF ±10%, 50V X7R ceramic capacitor (0805) Murata GRM21BR71H105K
C9	1	1µF ±10%, 16V X5R ceramic capacitor (0603) Murata GRM188R61C105K
C11	1	33nF ±10%, 16V X7R ceramic capacitor (0603) Murata GRM188R71C333K
C12, C13	2	10pF ±5%, 50V C0G ceramic capacitors (0603) Murata GRM1885C1H100J
C14, C25	2	10µF ±20%, 6.3V X5R ceramic capacitors (0603) Murata GRM188R60J106M

DESIGNATION	QTY	DESCRIPTION
C16, C17	2	22pF ±5%, 50V C0G ceramic capacitors (0603) Murata GRM1885C1H220J Murata GRM1885C1H220J
D1–D4, D9, D10	6	Hyper-bright, low-current, green LEDs (0603)
D5, D6	2	40V, 2A Schottky rectifiers Diodes, Inc. DFSL240
D7	1	33V, 4A TVS diodes Semtech SDC36C.TCT
FB1	1	0.1Ω DCR, 30Ω at 100MHz ferrite bead Murata BLM18PG300SN1
J1	0	Not installed, 10-pin (2 x 5) header
J2	1	10-pin (2 x 5) dual-row header
J4	1	USB type-B right-angle receptacle
JU1, JU9–JU12, JU14–JU20	12	2-pin headers
JU2, JU6, JU7, JU8	4	4-pin headers
JU3	1	20-pin (2 x 10) dual-row header
JU4, JU5	2	3-pin headers
R1, R5, R14	3	10kΩ ±5% resistors (0603)
R3, R6, R7, R10, R11, R17	6	1.5kΩ ±5% resistors (0603)
R12	1	2.2kΩ ±5% resistor (0603)
R13	1	470Ω ±5% resistor (0603)
R15, R16	2	0Ω ±5% resistors (0603)

IO-Link is a registered trademark of ifm electronic GmbH.

Windows, Windows XP, and Windows Vista are registered trademarks and reistered service marks of Microsoft Corp.

For pricing, delivery, and ordering information, please contact Maxim Direct at 1-888-629-4642, or visit Maxim Integrated's website at www.maximintegrated.com.

MAX14824 Evaluation Kit

Evaluates: MAX14824

Component List (continued)

DESIGNATION	QTY	DESCRIPTION
R18, R19	2	27Ω ±5% resistors (0603)
R20–R23	4	22kΩ ±5% resistors (0603)
R24	1	0.5Ω ±1% resistor (2010)
TP1, TP5–TP8, TP20	6	Red multipurpose test points
TP2, TP9	2	Black multipurpose test points
TP3, TP4, TP10–TP19	12	Yellow multipurpose test points
U1	1	IO-Link master transceiver (24 TQFN-EP*) Maxim MAX14824GTG+
U2	1	Microcontroller (68 QFN-EP*) Maxim MAXQ2000-RAX+
U3	1	2.5V LDO regulator (5 SC70) Maxim MAX8511EXK25+

*EP = Exposed pad.

DESIGNATION	QTY	DESCRIPTION
U4	1	USB-to-UART converter (32 LQFP)
U5	1	93C46 type (64k x 16) 3-wire EEPROM (8 SO)
U6	1	3.3V LDO regulator (5 SC70) Maxim MAX8511EXK33+
Y1	1	16MHz crystal Hong Kong X'tals SSM16000N1HK188F0-0
Y2	1	6MHz crystal Hong Kong X'tals SSL6000N1HK188F0-0
—	1	USB high-speed A-to-B cable
—	28	Shunts
—	1	PCB: MAX14824 EVALUATION KIT

Component Suppliers

SUPPLIER	PHONE	WEBSITE
Hong Kong X'tals Ltd.	852-35112388	www.hongkongcrystal.com
Murata Electronics North America, Inc.	770-436-1300	www.murata-northamerica.com
Semtech Corporation	805-498-2111	www.semtech.com

Note: Indicate that you are using the MAX14824 when contacting these component suppliers.

MAX14824 EV Kit Files

FILE	DESCRIPTION
INSTALL.EXE	Installs the EV kit files on your computer
14824.EXE	Application program
CDM20600.EXE	Installs the USB device driver
UNINST.EXE	Uninstalls the EV kit software
USB_Driver_Help_200.PDF	USB driver installation help file

MAX14824 Evaluation Kit

Evaluates: MAX14824

Quick Start

Recommended Equipment

- MAX14824 EV kit (USB A-to-B cable included)
- User-supplied Windows XP, Windows Vista, or Windows 7 PC with a spare USB port
- 24V, 100mA DC power supply

Note: In the following sections, software-related items are identified by bolding. Text in **bold** refers to items directly from the EV kit software. Text in **bold and underlined** refers to items from the Windows operating system.

Procedure

The EV kit is fully assembled and tested. Follow the steps below to verify board operation before exercising the full features of the device:

- 1) Visit www.maximintegrated.com/evkitsoftware to download the latest version of the EV kit software, 14824Rxx.ZIP. Save the EV kit software to a temporary folder and uncompress the ZIP file.
- 2) Install the EV kit software and USB driver on your computer by running the INSTALL.EXE program inside the temporary folder. The program files are copied to your PC and icons are created in the Windows **Start | Programs** menu. During software installation, some versions of Windows may show a warning message indicating that this software is from an unknown publisher. This is not an error condition and it is safe to proceed with installation. Administrator privileges are required to install the USB device driver on Windows.
- 3) Verify that all the jumpers are set in their default positions, as shown in Table 1.
- 4) Connect the 24V DC power supply on the VCC and GND connectors on the EV kit board.
- 5) Connect the USB cable from the PC to the EV kit board. A Windows message appears when connecting the EV kit board to the PC for the first time. Each version of Windows has a slightly different message. If you see a Windows message stating **ready to use**, then proceed to the next step. Otherwise, open the **USB_Driver_Help_200.PDF** document in the Windows **Start | Programs** menu to verify that the USB driver was installed successfully.
- 6) Start the EV kit software by opening its icon in the Windows **Start | Programs** menu. The EV kit software address verification reminder window appears, as shown in Figure 1. Press the **OK** button to proceed.
- 7) The EV kit software main window appears, as shown in Figure 2.
- 8) In the **Address Setting** group box, press the **Address Setting Verified** button. The software automatically reads and displays the current register values and device input and output logic levels.
- 9) Verify that **Hardware: Connected** is displayed on the status bar at the bottom of the main window.
- 10) Press the **Read** or **Write** buttons on the GUI to access the device SPI registers.

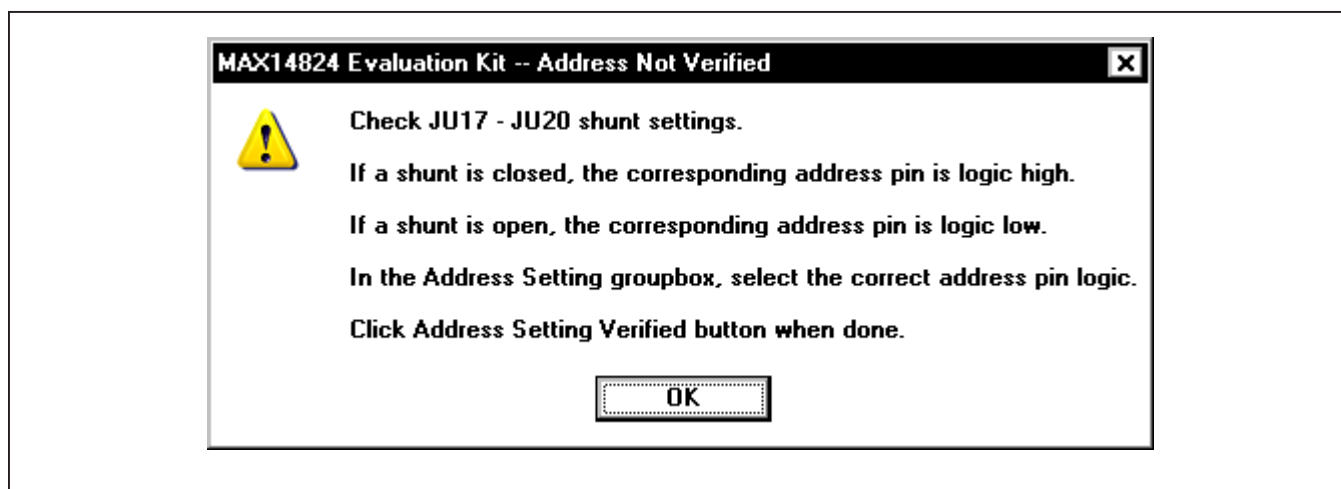

Figure 1. MAX14824 EV Kit Software Address Verification Reminder Window

MAX14824 Evaluation Kit

Evaluates: MAX14824

Detailed Description of Software

The main window of the evaluation software (Figure 2) displays the SPI registers and the device pins that are connected to the on-board MAXQ2000 microcontroller. The user can send read or write SPI commands to the device, configure the logic levels of the device input pins, and read back the logic levels of the device output pins.

To read an SPI register or an output pin logic level, press the **Read** button.

To configure an SPI register or an input pin logic level, first click on the desired radio button(s), and then press the **Write** button.

The user can also change the SPI clock speed by clicking on the desired **SPI Clock Speed** radio button.

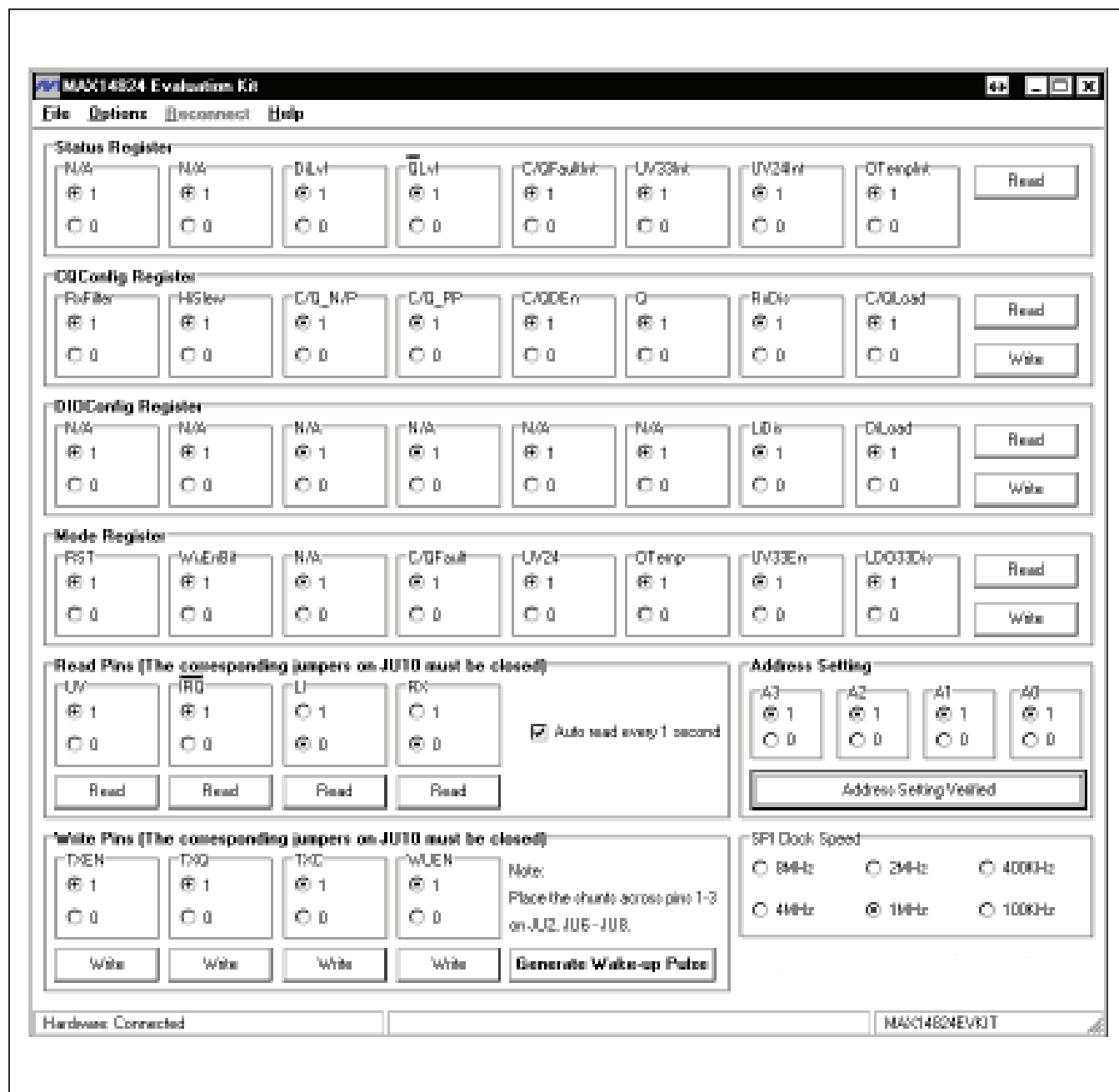

Figure 2. MAX14824 EV Kit Software Main Window

MAX14824 Evaluation Kit

Evaluates: MAX14824

Advanced User Interface

There are two methods for communicating with the device. The first is through the window shown in Figure 2. The second is through the **Advanced User Interface** window shown in Figure 3. The **Advanced User Interface** window becomes available by selecting the **Options | Interface (Advanced User)** menu item and allows execution of serial commands manually.

The **Advanced User Interface** window can also be used as a debug tool because it is capable of manually reading and writing to every register and logic pin of the device.

Detailed Description of Hardware

The MAX14824 EV kit provides a proven layout for the MAX14824 IO-Link master transceiver.

All the power-supply and regulator input and output pins are connected to convenient connectors for easy probing. The device logic input and output pins are also provided with convenient connectors for logic testing.

As an option, the user can also connect their own SPI controller to access the device registers.

The transceiver's C/Q and DI pins are protected by Semtech SDC36C TVS diodes.

See Table 1 for a description of all the EV kit jumper configurations.

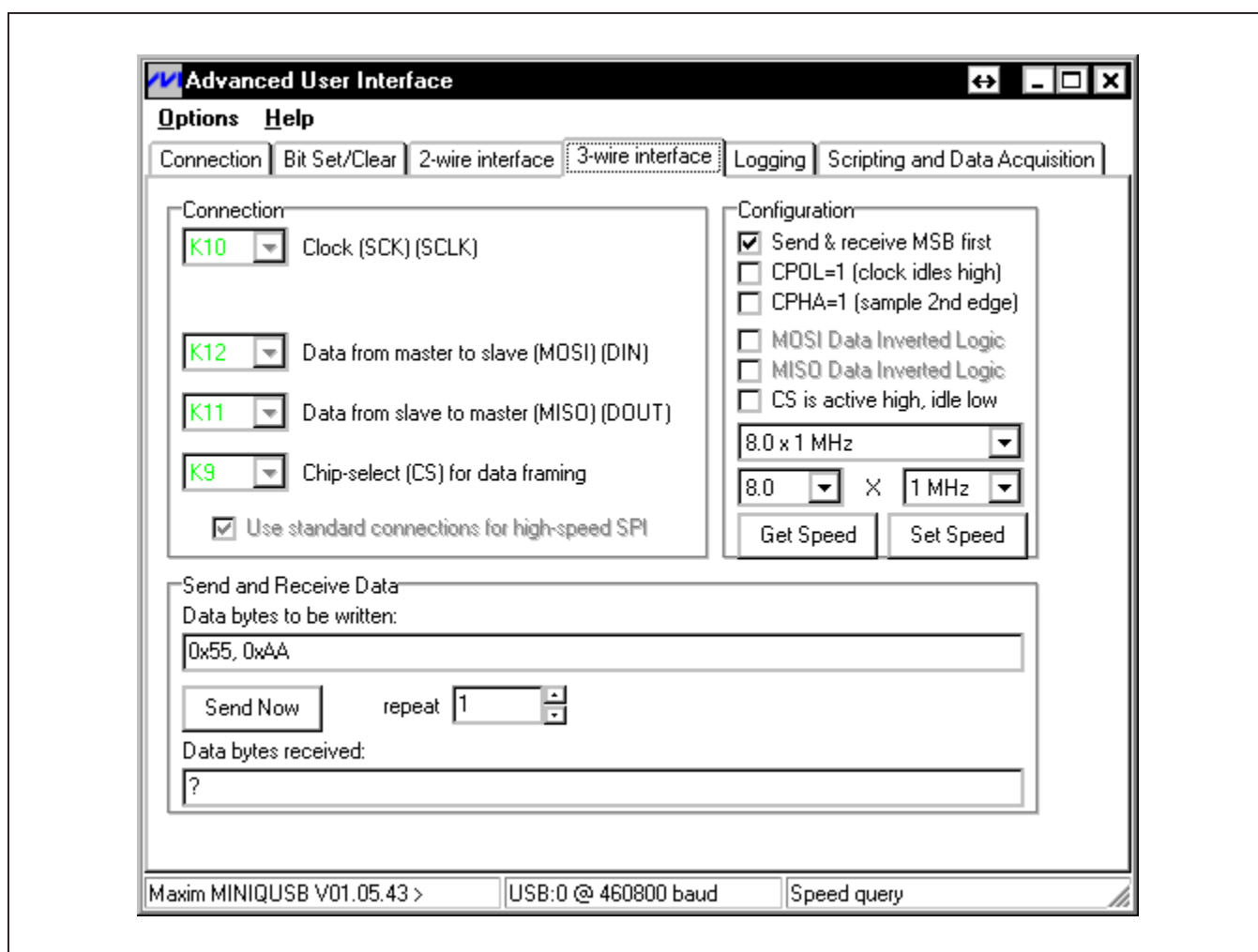

Figure 3. MAX14824 EV Kit Software Advanced User Interface Window

MAX14824 Evaluation Kit

Evaluates: MAX14824

Table 1. Jumper Descriptions

JUMPER	SHUNT POSITION	DESCRIPTION
JU1	Closed*	Enables the C/Q LED indicator
	Open	Disables the C/Q LED indicator
JU2	1-3*	WUEN pin is controlled by microcontroller through GUI
	1-2	WUEN pin is connected to VL
	1-4	WUEN pin is connected to GND
JU3	Closed*	Device logic IO pins are connected to on-board microcontroller
	Open	Device logic IO pins are disconnected from on-board microcontroller
JU4	1-2*	Device is powered by internal LDO
	2-3	Device is powered by external 5V connected to TP6
JU5	1-2*	Device VL is connected to LDO33
	2-3	Device VL is connected to V5
JU6	1-3*	TXEN pin is controlled by microcontroller through GUI
	1-2	TXEN pin is connected to VL
	1-4	TXEN pin is connected to GND
JU7	1-3*	TXQ pin is controlled by microcontroller through GUI
	1-2	TXQ pin is connected to VL
	1-4	TXQ pin is connected to GND
JU8	1-3*	TXC pin is controlled by microcontroller through GUI
	1-2	TXC pin is connected to VL
	1-4	TXC pin is connected to GND
JU9–JU12	Closed*	Device uses on-board SPI interface
	Open	Device uses external SPI interface
JU14	Closed*	Enables the RX LED indicator
	Open	Disables the RX LED indicator
JU15	Closed*	Enables the $\overline{\text{IRQ}}$ LED indicator
	Open	Disables the $\overline{\text{IRQ}}$ LED indicator
JU16	Closed*	Enables the LI LED indicator
	Open	Disables the LI LED indicator
JU17–JU20	Closed*	Device address pin set to logic-high
	Open	Device address pin set to logic-low

*Default position.

MAX14824 Evaluation Kit

Evaluates: MAX14824

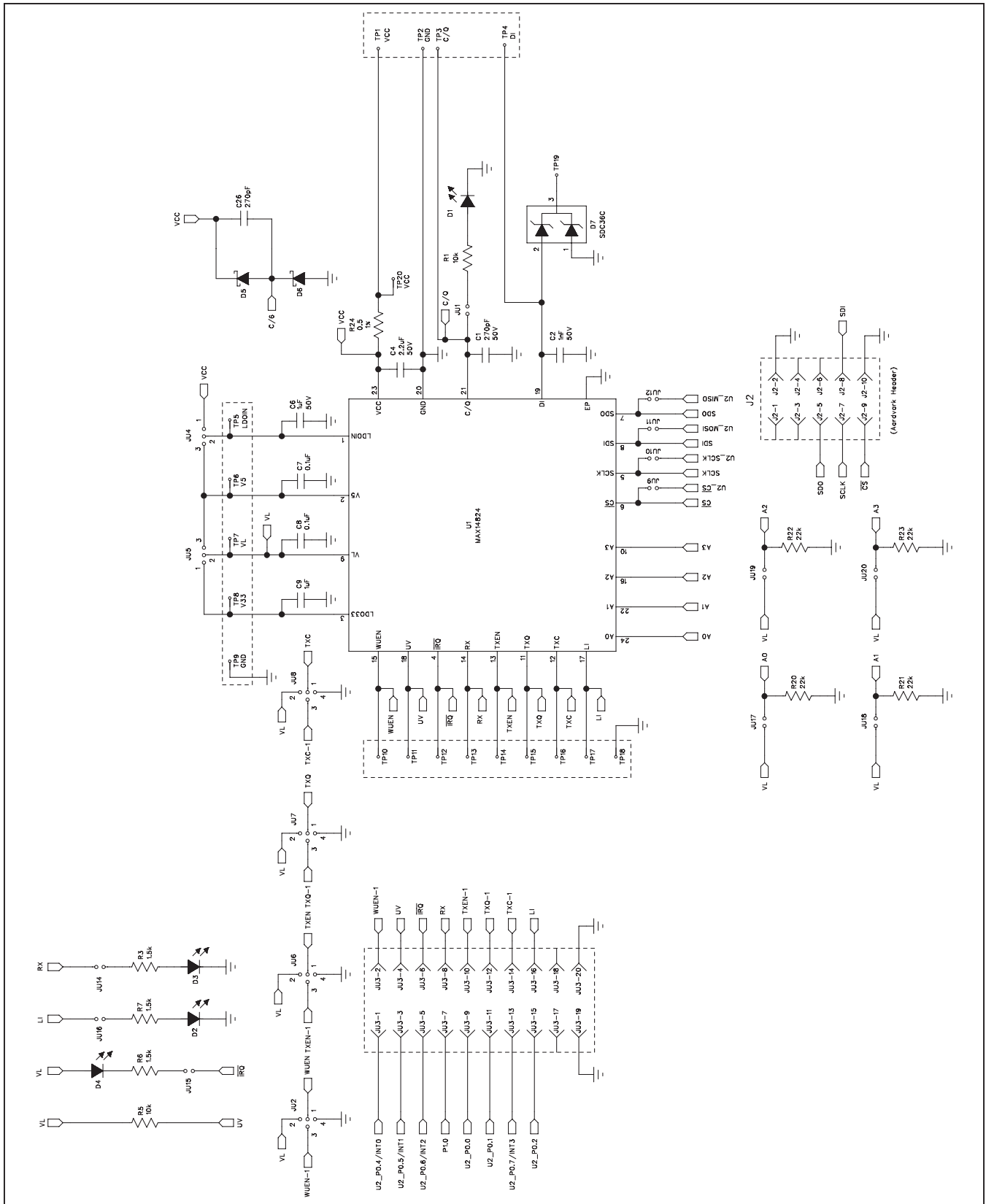

Figure 4a. MAX14824 EV Kit Schematic (Sheet 1 of 2)

MAX14824 Evaluation Kit

Evaluates: MAX14824

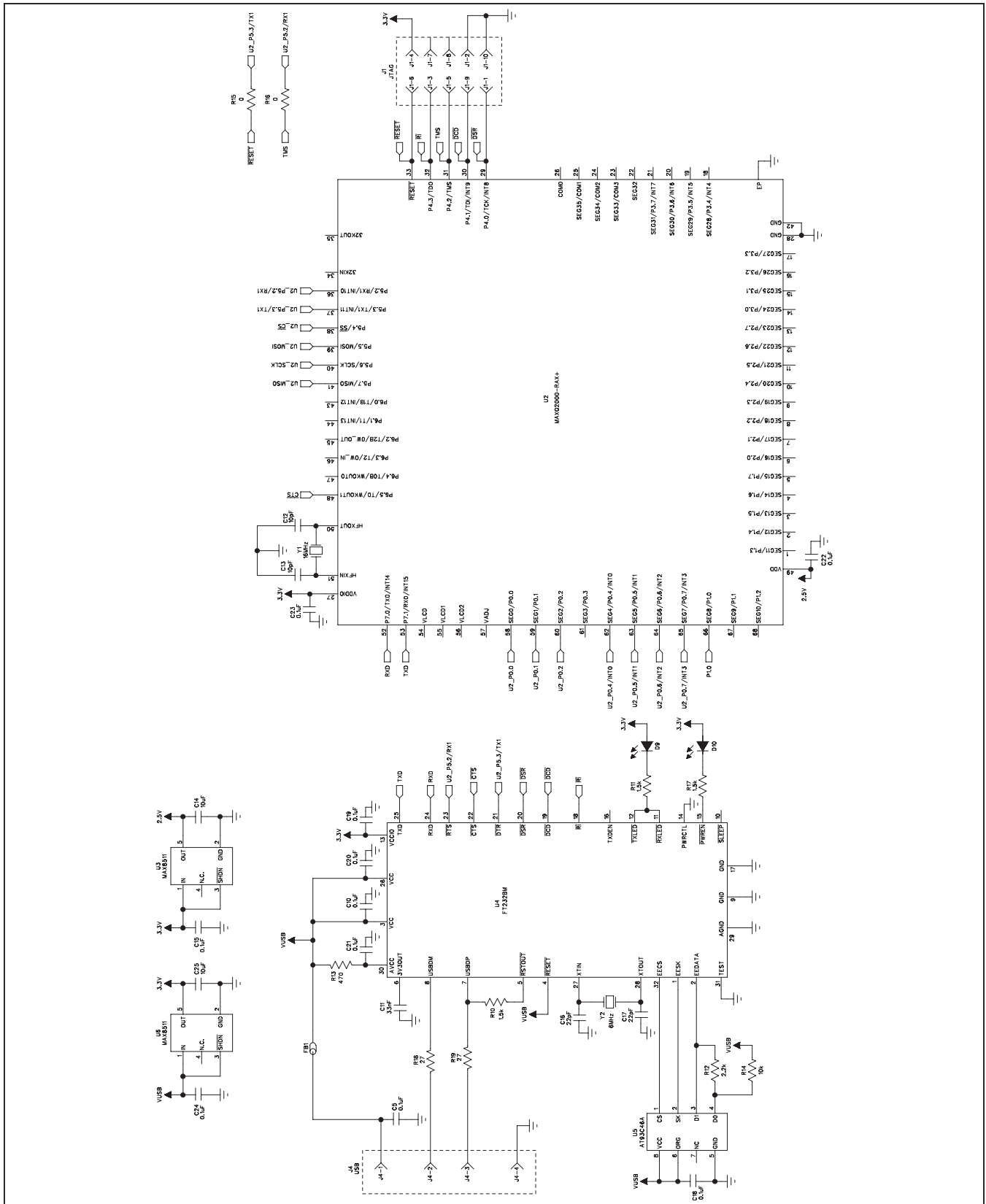

Figure 4b. MAX14824 EV Kit Schematic (Sheet 2 of 2)

MAX14824 Evaluation Kit

Evaluates: MAX14824

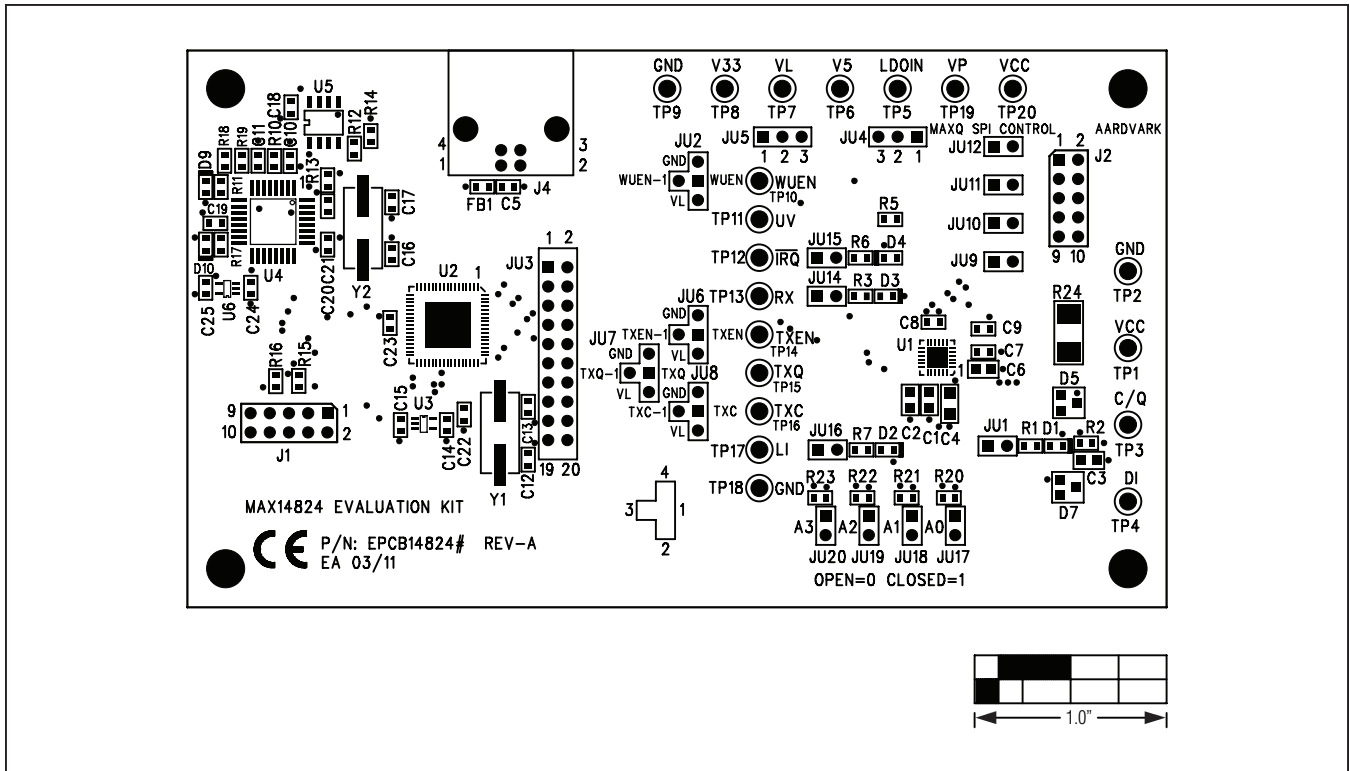

Figure 5. MAX14824 EV Kit Component Placement Guide—Component Side

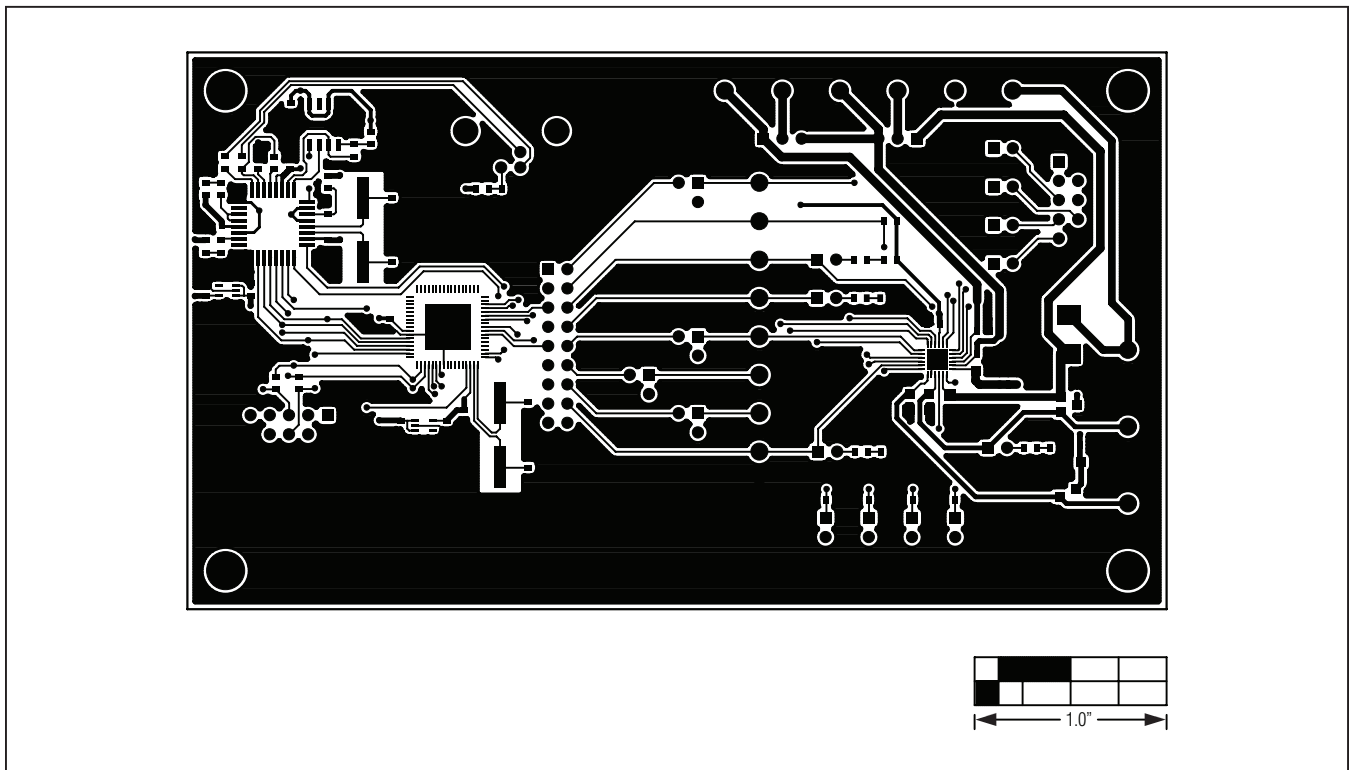

Figure 6. MAX14824 EV Kit PCB Layout—Component Side

MAX14824 Evaluation Kit

Evaluates: MAX14824

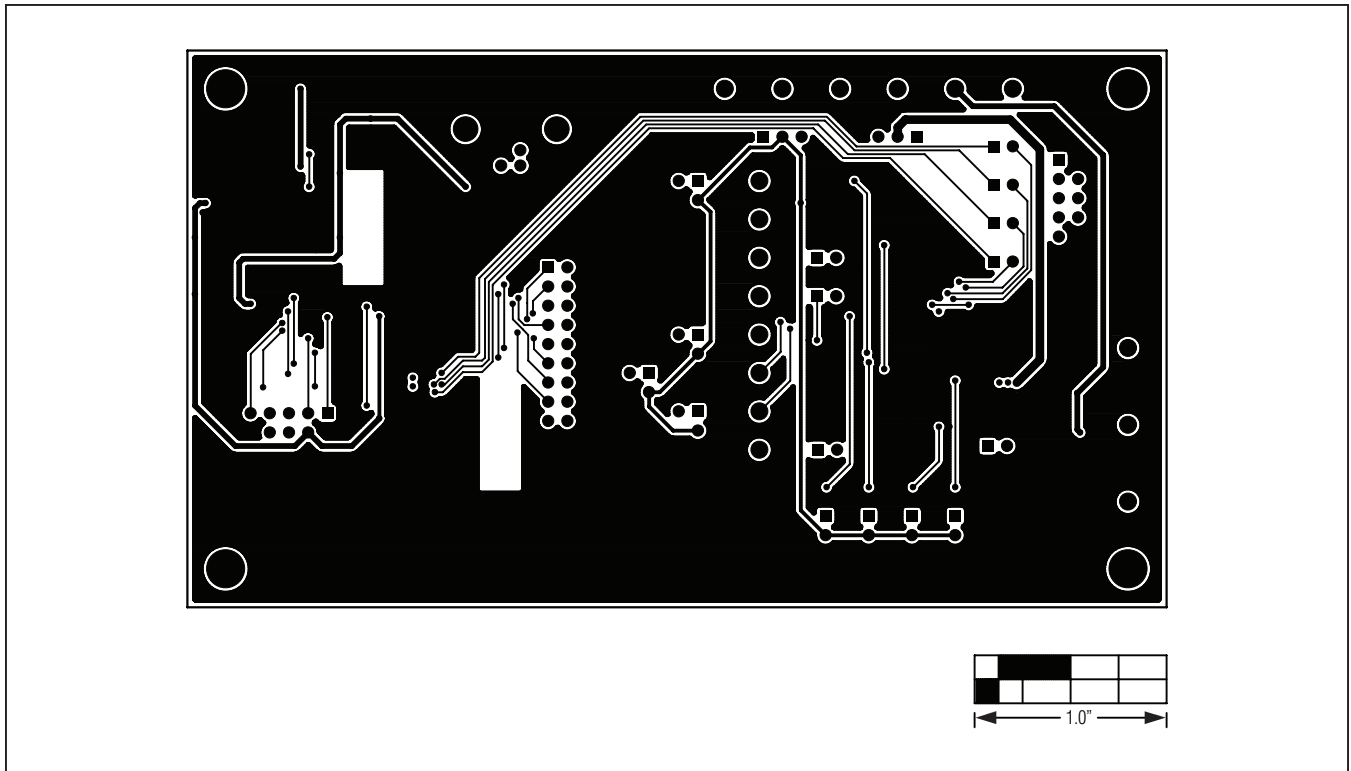

Figure 7. MAX14824 EV Kit PCB Layout—Solder Side

MAX14824 Evaluation Kit

Evaluates: MAX14824

Ordering Information

PART	TYPE
MAX14824EVKIT#	EV Kit

#Denotes RoHS compliant.

MAX14824 Evaluation Kit

Evaluates: MAX14824

Revision History

REVISION NUMBER	REVISION DATE	DESCRIPTION	PAGES CHANGED
0	6/11	Initial release	—
1	8/12	Updated component list; updated Figure 4a	1, 2, 7
2	1/13	Removed components C3 and R2 to correspond with schematic	1



Maxim Integrated cannot assume responsibility for use of any circuitry other than circuitry entirely embodied in a Maxim Integrated product. No circuit patent licenses are implied. Maxim Integrated reserves the right to change the circuitry and specifications without notice at any time.

Maxim Integrated 160 Rio Robles, San Jose, CA 95134 USA 1-408-601-1000

12