

Cylindrical Inductive Sensors with Separate Amplifiers Provide Variable Detecting Capabilities

- Separate amplifier allows sensor to fit in space-confined sites, providing easy access for monitoring and remote adjustments
- Detecting distance and differential travel can be adjusted to meet specific application requirements
- Adjustable differential travel to set switching trigger point available on some amplifiers



Ordering Information

■ SENSORS

Miniature Sizes

Sensor type	Shielded				
Size	2.0 mm dia.	3.5 mm dia.	3.8 mm dia.	M5	5.4 mm dia.
Nominal detecting distance	0.5 mm (0.02 in)	0.8 mm (0.03 in)	0.8 mm (0.03 in)	1 mm (0.04 in)	1 mm (0.04 in)
Part number	E2C-CR5B	E2C-CR8A	E2C-CR8B	E2C-X1A	E2C-C1A

Standard Sizes

Sensor type	Shielded				Unshielded
Size	M8	M12	M18	M30	40 mm dia.
Nominal detecting distance	1.5 mm (0.06 in)	2 mm (0.08 in)	5 mm (0.20 in)	10 mm (0.39 in)	20 mm (0.79 in)
Part number	E2C-X1R5A	E2C-X2A	E2C-X5A	E2C-X10A	E2C-C20MA

■ AMPLIFIERS

Socket-Mount Types

Size	1/16 DIN		Miniature			
Applicable sensors	All models		E2C-CR8A, E2C-CR8B, E2C-X1A, E2C-C1A, E2C-X1R5A		E2C-CR5B	
Supply voltage	90 to 264 VAC, 50/60 Hz	10 to 30 VDC	10 to 30 VDC			
Output type	Transistor and relay	Open collector NPN and PNP	NPN	PNP	NPN	PNP
Part number	E2C-AK4A	E2C-AM4A	E2C-GE4A	E2C-GF4A	E2C-GE4B	E2C-GF4B

■ AMPLIFIERS

Track-Mount Types

Size	Prewired	Screw terminal
Applicable sensors	E2C-CR8A, E2C-X1A, E2C-C1A E2C-X1R5A, E2C-X2A	E2C-CR8A, E2C-X1A, E2C-C1A, E2C-X1R5A
Supply voltage	10 to 30 VDC,	
Output type	NPN with alarm output	Open collector NPN and PNP
Part number	E2C-JC4AP	E2C-WH4AF

■ ACCESSORIES

Description		Part number	
Mounting brackets for sensors	Fits 3.5 mm and 3.8 mm dia. unthreaded sensor	Y92E-F3R5	
	Fits M8 size threaded sensor	Y92E-B8	
	Fits M12 size threaded sensor	Y92E-B12	
	Fits M18 size threaded sensor	Y92E-B18	
	Fits M30 size threaded sensor	Y92E-B30	
Sockets for amplifiers	E2C-AK4A amplifier	Bottom surface or track mounting, top screw terminals	P2CF-11
		Panel mounting, bottom solder terminal	PL11
		Back mounting, for use with Y92F-30 mounting adapter, bottom screw terminals	P3G-11
	E2C-AM4A amplifier	Bottom surface or track mounting, top screw terminals	P2CF-08
		Panel mounting, bottom solder terminals	PL08
		Back mounting, for use with Y92F-30 mounting adapter, bottom screw terminals	P3G-08
	E2C-G□4□ amplifiers	Bottom surface or track mounting, top screw terminals	PYF08A-E
		Panel mounting, bottom solder terminals	PY08
		Bottom surface mounting, bottom screw terminals	PYF08M
Panel mounting adapters for E2C-A□4A amplifiers	Fits behind panel; ideal for side by side installation. Use P2CF-□□ sockets.	Y92F-30	
	Installs through panel front; amplifier face fits bezel, rear of amplifier clips to adapter. Use P3G-□□ sockets. Charcoal gray.	Y92F-70	
Protective covers for E2C-A□4A amplifiers	Hard plastic cover; not for use with Y92F-70 panel adapter	Y92A-48	
	Soft plastic cover; not for use with Y92F-70 panel adapter	Y92A-48D	
Mounting track	DIN rail, 50 cm (1.64 ft) length	PFP-50N	
	DIN rail, 1 m (3.28 ft) length	PFP-100N	
	End plate	PFP-M	
	Spacer	PFP-S	

■ REPLACEMENT PARTS

Description		Part number
Mounting hardware includes one pair of metal nuts and washers	Fits M5 size sensors (supplied with each sensor)	M5-MHWS
	Fits M8 size sensors (supplied with each sensor)	M8-MHWS
	Fits M12 size sensors (supplied with each sensor)	M12-MHWS
	Fits M18 size sensors (supplied with each sensor)	M18-MHWS
	Fits M30 size sensors (supplied with each sensor)	M30-MHWS

Specifications

■ MINIATURE SENSORS

Part number	E2C-CR5B	E2C-CR8A	E2C-CR8B	E2C-X1A	E2C-C1A	
Sensor type	Inductive					
Body	Size	2.0 mm dia.	3.5 mm dia.	3.8 mm dia.	M5	5.4 mm dia.
	Type	Shielded				
Required amplifier	E2C-AK4A, E2C-AM4A, E2C-GE4B or E2C-GF4B	E2C-AK4A, E2C-AM4A, E2C-GE4A, E2C-GF4A, E2C-JC4AP or E2C-WH4AF				
Detectable object type	Metallic objects					
Usable setting distance at ambient (with standard target)	0 to 0.5 mm (0 to 0.02 in)	0 to 0.8 mm (0 to 0.03 in)		0 to 1.0 mm (0 to 0.04 in)		
Usable setting distance at 0° to 40°C (with standard target)	0 to 0.7 mm (0 to 0.028 in)	0 to 1.2 mm (0 to 0.047 in)		0 to 1.5 mm (0 to 0.059 in)		
Standard target size (mild steel, L x W x H)	5 x 5 x 1 mm (0.20 x 0.20 x 0.04 in)					
Differential travel	See "Differential Travel" tables					
Response frequency	1 kHz					
Materials	Housing	304 stainless steel			Nickel-plated brass	
	Sensing face	ABS				
	Cable sheath	Polyethylene				
Mounting	—	Optional mounting strap Y92E-F3R5, order separately		Two lock washers and M5 nuts included	—	
Connections	Prewired	Two-conductor cable, 3 m (9.8 ft) length				
Weight with cable	10 g (0.4 oz.)	40 g (1.4 oz.)		45 g (1.6 oz.)		
Enclosure ratings	UL	—				
	NEMA	1,2	1, 3, 4, 6, 12, 13			
	IEC 144	IP64	IP67			
Approvals	UL	—				
	CSA	—				
Ambient operating temperature	-25° to 70°C (-13° to 158°F)					
Vibration	10 to 55 Hz, 1.5 mm (0.06 in) double amplitude, 2 hours each, X and Y directions					
Shock	50 G's, 3 times each, X and Y directions					

■ STANDARD SIZE SENSORS

Part number		E2C-X1R5A	E2C-X2A	E2C-X5A	E2C-X10A	E2C-C20MA
Sensor type		Inductive				
Body	Size	M8	M12	M18	M30	40 mm dia.
	Type	Shielded				Unshielded
Required amplifier		E2C-JC4AP, E2C-AK4A or E2C-AM4A		E2C-AK4A or E2C-AM4A		
Detectable object type		Metallic objects				
Usable setting distance at ambient (with standard target)		0 to 1.5 mm (0 to 0.06 in)	0 to 2 mm (0 to 0.08 in)	0 to 5 mm (0 to 0.20 in)	0 to 10 mm (0 to 0.39 in)	0 to 20 mm (0 to 0.79 in)
Usable setting distance 0° to 40°C (with standard target)		0 to 2 mm (0 to 0.079 in)	0 to 2.5 mm (0 to 0.098 in)	0 to 7 mm (0 to 0.276 in)	0 to 15 mm (0 to 0.591 in)	0 to 28 mm (0 to 1.102 in)
Standard target size (mild steel, L x W x H)		8 x 8 x 1 mm (0.32 x 0.32 x 0.04 in)	12 x 12 x 1 mm (0.47 x 0.47 x 0.04 in)	18 x 18 x 1 mm (0.71 x 0.71 x 0.04 in)	30 x 30 x 1 mm (1.18 x 1.18 x 0.04 in)	50 x 50 x 1 mm (1.97 x 1.97 x 0.04 in)
Differential travel		See "Differential Travel" tables				
Response frequency		800 Hz		350 Hz	100 Hz	50 Hz
Materials	Housing	Nickel-plated brass				
	Sensing face	ABS				
	Cable sheath	Polyethylene				
Mounting		Two lock washers and M8 nuts included. Bracket Y92E-B8 optional.	Two lock washers and M12 nuts included. Bracket Y92E-B12 optional.	Two lock washers and M18 nuts included. Bracket Y92E-B18 optional.	Two lock washers and M30 nuts included. Bracket Y92E-B30 optional.	—
Connections	Prewired	Two-conductor cable, 3 m (9.8 ft) length				
Weight with cable		50 g (1.8 oz.)	60 g (2.1 oz.)	140 g (4.9 oz.)	270 g (9.5 oz.)	300 g (10.6 oz.)
Enclosure ratings	UL	—				
	NEMA	1, 3, 4, 6, 12, 13				
	IEC 144	IP67				
Approvals	UL	—				
	CSA	—				
Ambient operating temperature		-25° to 70°C (-13° to 158°F)				
Vibration		10 to 55 Hz, 1.5 mm (0.06 in) double amplitude, 2 hours each, X and Y directions				
Shock		50 G's, 3 times each, X and Y directions				

■ AMPLIFIERS

Socket-Mount Type

Part number		E2C-AK4A	E2C-AM4A	E2C-GE4A	E2C-GF4A	E2C-GE4B	E2C-GF4B	
Supply voltage		90 to 264 VAC, 50/60 Hz	10 to 30 VDC					
Current consumption		55 mA max.	25 mA max.					
Differential travel		See "Differential Travel" tables						
Control output	Relay	Type	SPDT	—				
		Max. load	2 A, 250 VAC (p.f. = 1)	—				
		Min. load	1 mA, 5 VDC	—				
	DC solid-state	Type	Transistor, SPST	One NPN open collector, one PNP open collector	NPN open collector with pull-up	PNP open collector with pull-down	NPN open collector with pull-up	PNP open collector with pull-down
		Max. load	50 mA, 40 VDC	200 mA	100 mA			
		Max. on-state voltage drop	2 VDC	1.5 VDC				
Indicators		Output Operation (red LED) and Output Stability (red LED)		Output Operation (red LED)				
Materials	Case	Plastic						
Mounting		Requires P2CF-11, PL11 or P3G-11 socket (not included). Order separately from Accessories.	Requires P2CF-08, PL08 or P3G-08 socket (not included). Order separately from Accessories.	Requires PYF08A-E, PY08 or PYF08M socket (not included). Order separately from Accessories.				
Connections		Plated steel screw terminals or solder terminals, refer to sockets in Accessories section.						
Weight (not including socket)		250 g (8.8 oz.)	140 g (4.9 oz.)	20 g (0.7 oz.)				
Enclosure ratings	UL	—						
	NEMA	1						
	IEC 144	IP 40						
Approvals	UL	—						
	CSA	—						
Ambient operating temperature		-10° to 55°C (14° to 131°F)						
Vibration		10 to 25 Hz, 2 mm (0.08 in) double amplitude, 2 hours each, X and Y directions						
Shock		10 G's, 3 times each, X and Y directions						

■ AMPLIFIERS

Track-Mount Type

Part number		E2C-JC4AP	E2C-WH4AF	
Supply voltage		10 to 30 VDC		
Current consumption		45 mA	25 mA	
Differential travel		See "Differential Travel" tables		
Control output	DC solid-state	Type	NPN open collector	One NPN open collector, one PNP open collector
		Max. load	100 mA	200 mA
		Max. on-state voltage drop	1 VDC	0.7 VDC
Alarm output	Type	NPN open collector	Not provided	
	Max. load	50 mA	—	
Indicators		Output Operation (red LED), Output Stability (green LED)	Output Operation (red LED)	
Materials	Case	Plastic		
Mounting		DIN rail track, E39-L48 mounting bracket, or two side through holes	DIN rail track or bottom surface with two through holes	
Connections		Prewired, 4-conductor cable, 2 m (6.56 ft) length	Terminal screws or direct connection to S308 sensor controller with E99-C connector (included).	
Weight		80 g (2.8 oz.) with cable	80 g (2.8 oz.) with cable	
Enclosure ratings	UL	—		
	NEMA	1		
	IEC 144	IP 40		
Approvals	UL	—		
	CSA	—		
Ambient operating temperature		-10° to 55°C (14° to 131°F)		
Vibration		10 to 25 Hz, 2 mm (0.08 in) double amplitude, 2 hours each, X and Y directions		
Shock		10 G's, 3 times each, X and Y directions		

■ DIFFERENTIAL TRAVEL

E2C-AK4A and E2C-AM4A amplifiers

Amplifier part number	Sensor part number	Differential travel (% of detecting distance)	
		At minimum detecting distance	At maximum detecting distance
E2C-AK4A	E2C-CR5B	1 to 5%, adjustable	1 to 5%, adjustable
	E2C-CR8A		
	E2C-CR8B		
	E2C-X1A		
	E2C-C1A		
	E2C-X1R5A		
	E2C-X2A		
	E2C-X5A		
	E2C-X10A		
	E2C-C20MA		
	E2C-AM4A		
E2C-CR8A			
E2C-CR8B			
E2C-X1A			
E2C-C1A			
E2C-X1R5A			
E2C-X2A			
E2C-X5A			
E2C-X10A			
E2C-C20MA			

E2C-G□4A, E2C-G□4B and E2C-WH4AF amplifiers

Amplifier part number	Sensor part number	Differential travel (% of detecting distance)	
		At minimum detecting distance	At maximum detecting distance
E2C-G□4A	E2C-CR8A,8B	2.0 to 4.7%, fixed	3.8 to 6.0%, fixed
	E2C-X1A	0.9 to 1.9%, fixed	0.4 to 3.8%, fixed
	E2C-C1A	0.5 to 2.6%, fixed	0.1 to 4.3%, fixed
	E2C-X1R5A	1.7 to 4.2%, fixed	2.7 to 6.0%, fixed
E2C-G□4B	E2C-CR5B	1.6 to 17.6%, fixed	4.4 to 19.2%, fixed
E2C-JC4AP, E2C-WH4AF	E2C-CR8A	2.0 to 4.7%, fixed	3.8 to 6.0%, fixed
	E2C-X1A	0.9 to 1.9%, fixed	0.4 to 3.8%, fixed
	E2C-C1A	0.5 to 2.6%, fixed	0.1 to 4.3%, fixed
	E2C-X1R5A	1.7 to 4.2%, fixed	2.7 to 6.0%, fixed

Operation

■ OUTPUT CIRCUIT DIAGRAMS

E2C-AK4A Amplifier

AC input, transistor and relay outputs

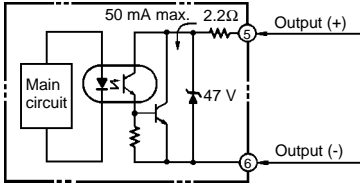

E2C-AM4A Amplifier

DC input, open collector NPN and PNP outputs

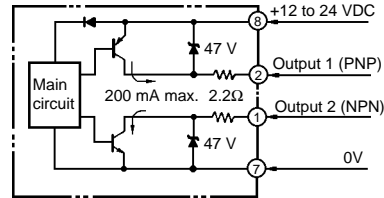

E2C-GE4□ Amplifiers

DC input, NPN or PNP outputs

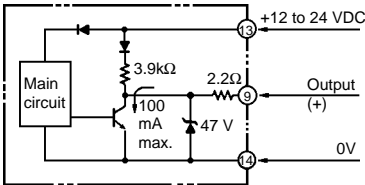

E2C-GF4□ Amplifiers

DC input, NPN and PNP outputs

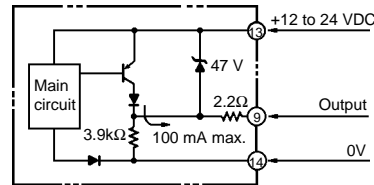

E2C-WH4AF Amplifier

DC input, open collector NPN and PNP outputs

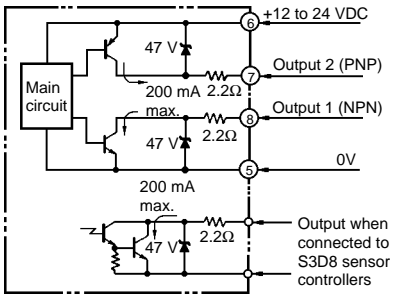

E2C-JC4AP Amplifier

DC input, open collector NPN output with alarm

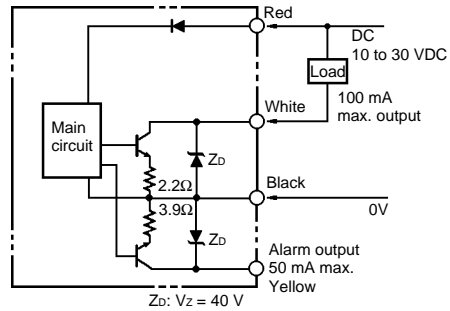

Engineering Data

OPERATING RANGE

**Shielded 2 mm dia. sensor
E2C-CR5B**

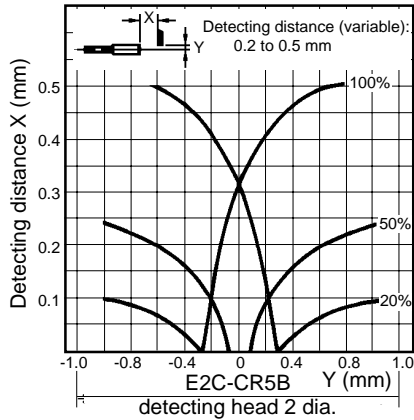

**Shielded 3.5 mm & 3.8 mm dia. sensor
E2C-CR8A, E2C-CR8B**

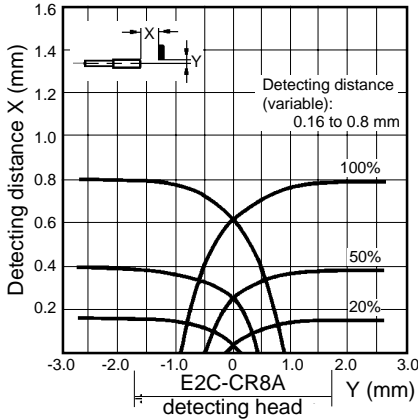

**Shielded M5 and 5.4 mm dia. sensors
E2C-X1A, E2C-C1A**

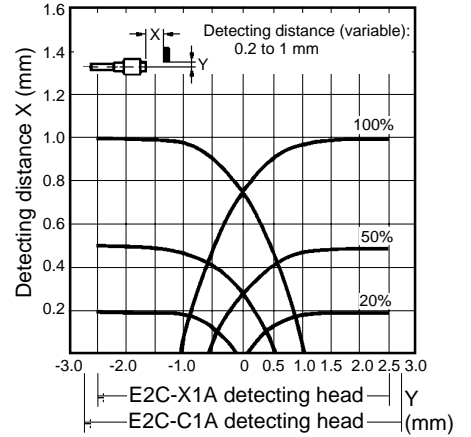

**Shielded M8 sensor
E2C-X1R5A**

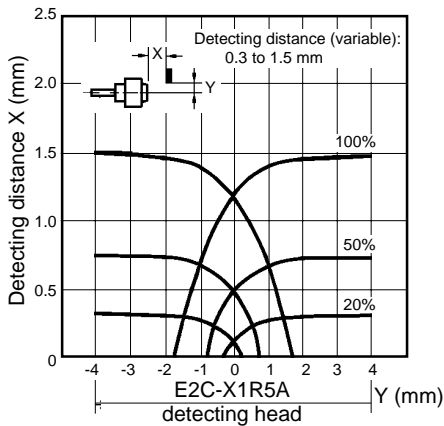

**Shielded M12 sensor
E2C-X2A**

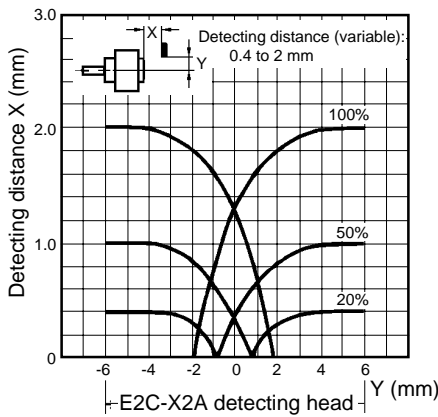

**Shielded M18 sensor
E2C-X5A**

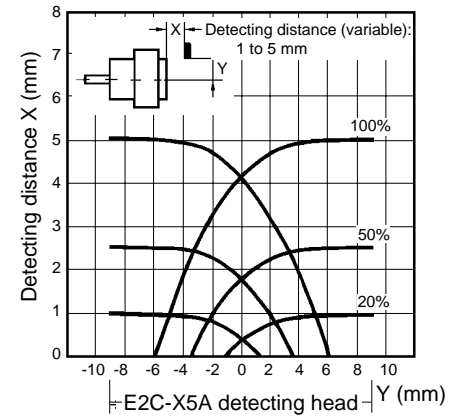

**Shielded M30 sensor
E2C-X10A**

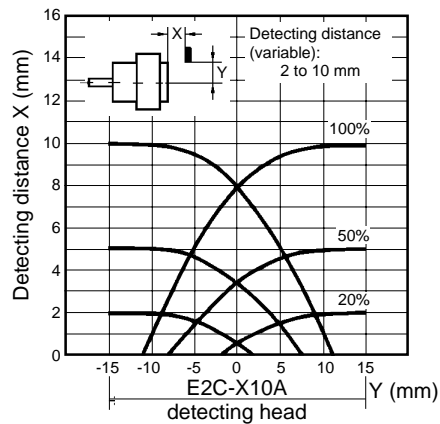

**Unshielded 40 mm dia. sensor
E2C-C20MA**

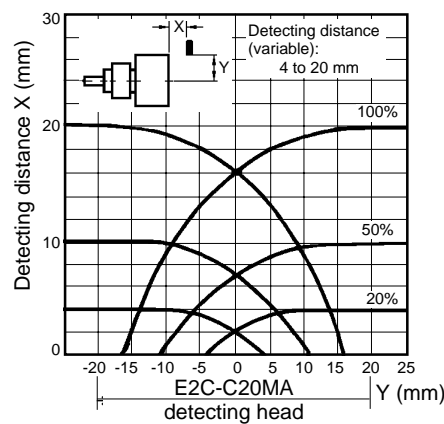

■ DETECTING DISTANCE vs. SIZE AND MATERIAL OF TARGET

Shielded 2 mm dia. sensor
E2C-CR5B

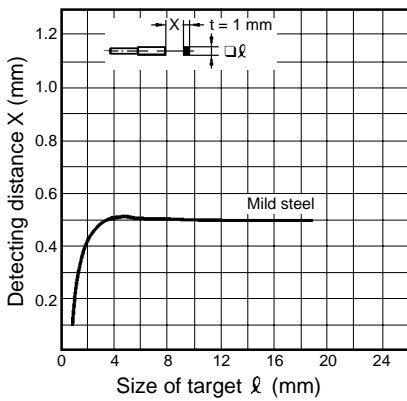

Shielded 3.5 mm & 3.8 mm dia. sensor
E2C-CR8A, E2C-CR8B

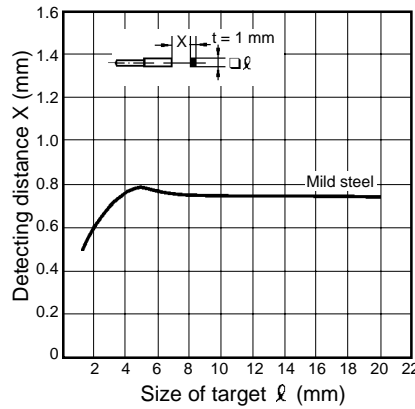

Shielded M5 and 5.4 mm dia. sensors
E2C-X1A, E2C-C1A

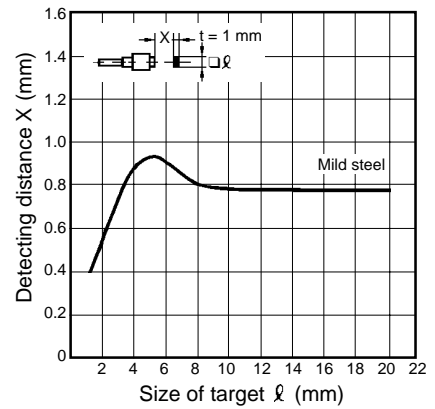

Shielded M8 sensor
E2C-X1R5A

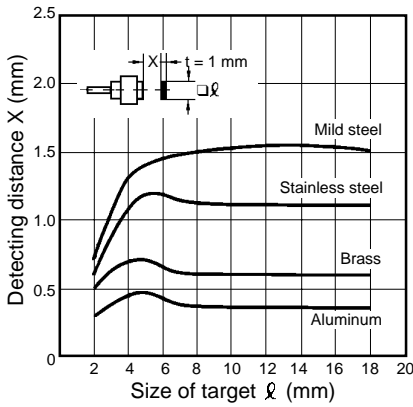

Shielded M12 sensor
E2C-X2A

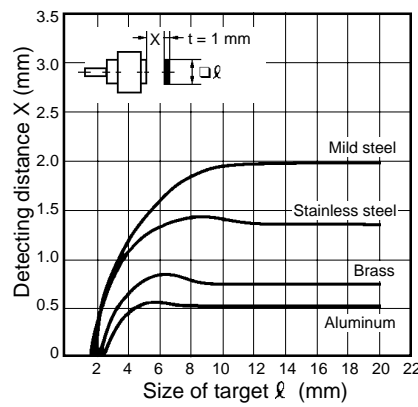

Shielded M18 sensor
E2C-X5A

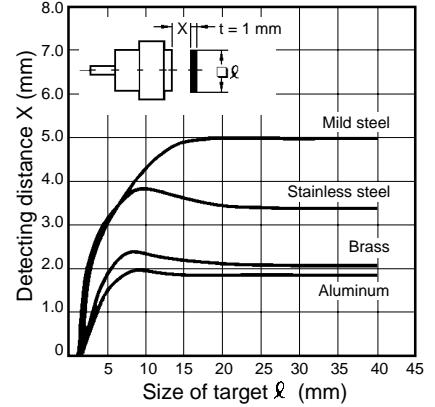

Shielded M30 sensor
E2C-X10A

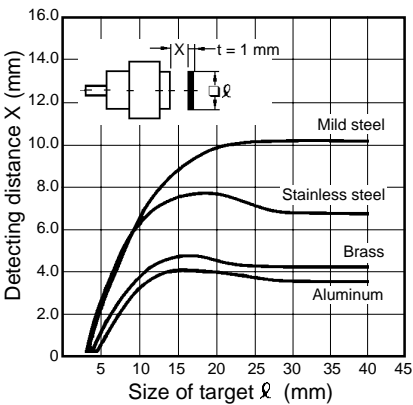

Unshielded 40 mm dia. sensor
E2C-C20MA

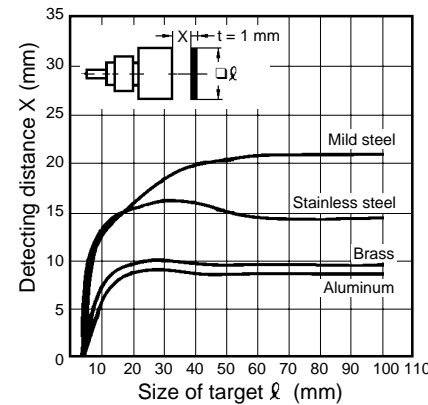

Note: If the target is a nonferrous metal, the operating distance of the proximity sensor decreases. However, with a piece of foil measuring about 0.01 mm (0.0004 inch) in thickness, the detecting distance is equivalent to that with a ferrous metal. Note that the proximity sensor cannot detect extremely thin evaporated films and non-conductive targets.

Dimensions

Unit: mm (inch)

■ SENSORS

Miniature Sizes

E2C-CR5B

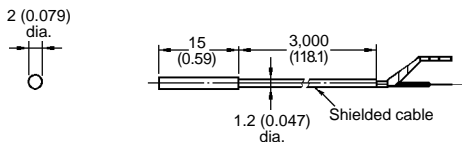

E2C-CR8A, E2C-CR8B

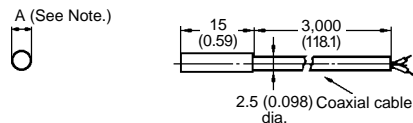

Note: For E2C-CR8A, A= 3.5 mm (0.14 in)
For E2C-CR8B, A=3.8 mm (0.15 in)

E2C-X1A

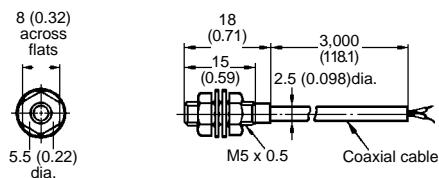

E2C-C1A

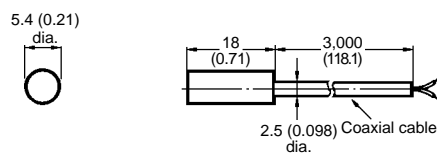

Standard Sizes

E2C-X1R5A

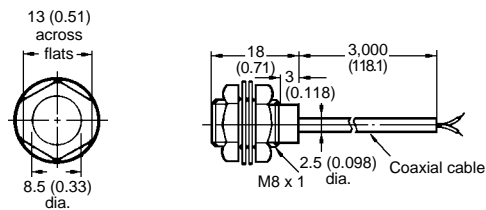

E2C-X2A

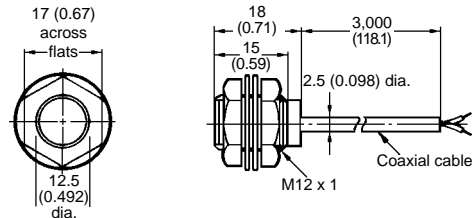

E2C-X5A

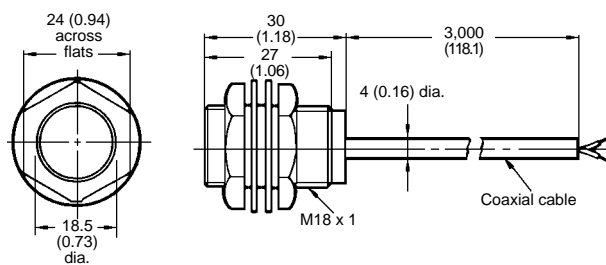

E2C-X10A

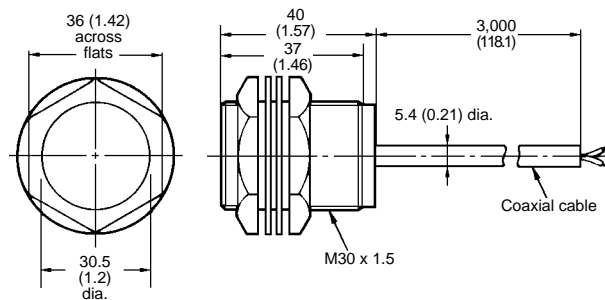

E2C-C20MA

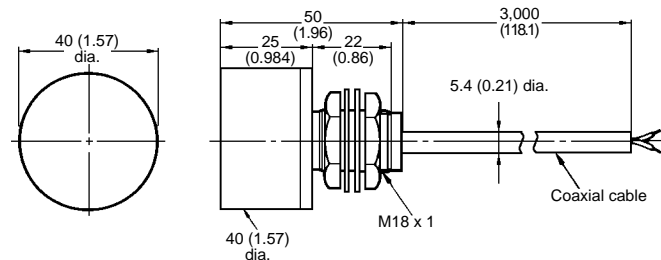

■ SOCKET-MOUNT AMPLIFIERS

1/16 DIN Size

E2C-AK4A AC type, fits 11-pin sockets
E2C-AM4A DC type, fits 8-pin sockets

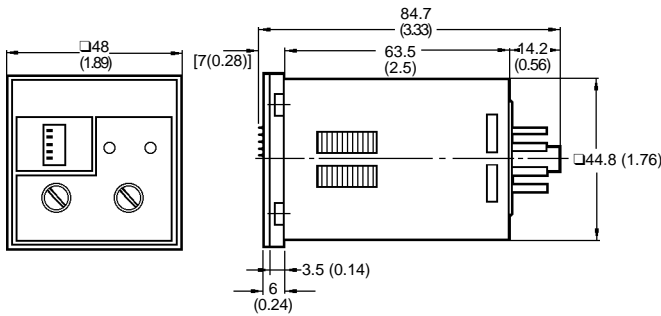

Miniature

E2C-G□4□

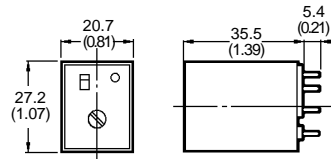

■ TRACK-MOUNT AMPLIFIERS

E2C-JC4AP

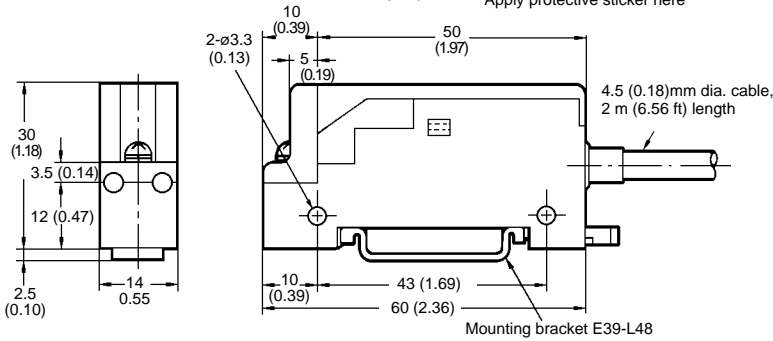
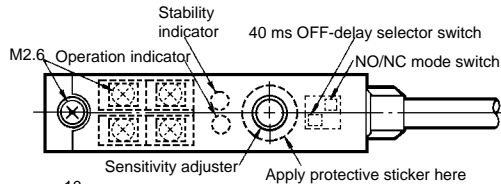

E2C-WH4AF

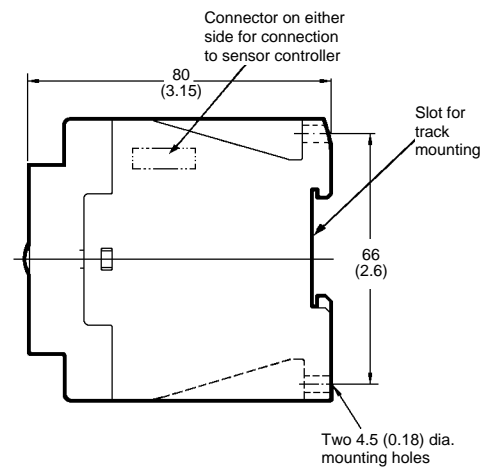
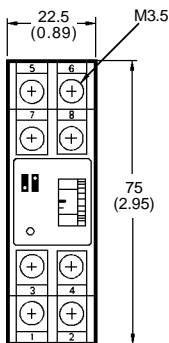

Mounting holes

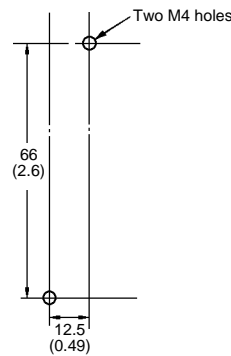

Note: When E2C-WH4AF amplifier is connected to S3D8 sensor controller, using the E99-C connector supplied, the amplifier is powered by the controller and the output is connected to the sensor controller.

OPTIONAL MOUNTING BRACKETS FOR STANDARD SIZE THREADED SENSORS

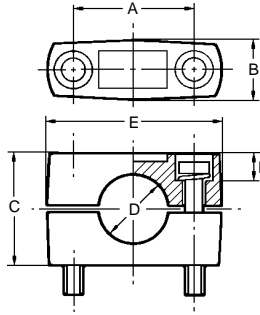

Part number	Drawing dimensions						Applicable sensor models
	A	B	C	D	E	F	
Y92E-B8	18 (0.71) ± 0.2	10 (0.39) max.	18 (0.71)	8 (0.31) dia.	28 (1.10) max.	M4 x 20 bolt	E2C-X1R5A
Y92E-B12	24 (0.94) ± 0.2	12.5 (0.49) max.	20 (0.79)	12 (0.47) dia.	37 (1.46) max.	M4 x 25 bolt	E2C-X2A
Y92E-B18	32 (1.26) ± 0.2	17 (0.67) max.	30 (1.18)	18 (0.71) dia.	47 (1.85) max.	M5 x 32 bolt	E2C-X5A
Y92E-B30	45 (1.77) ± 0.2	17 (0.67) max.	50 (1.97)	30 (1.18) dia.	60 (2.36) max.	M5 x 50 bolt	E2C-X10A

SOCKETS FOR AMPLIFIERS

11-Pin Sockets for E2C-AK4A Amplifier

P2CF-11 Bottom surface or track mounting socket

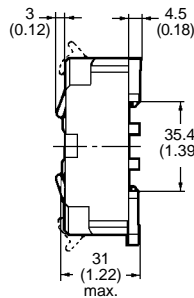
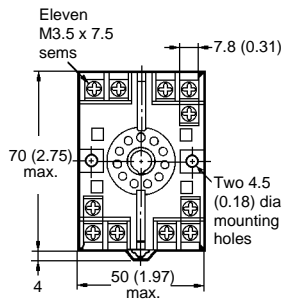

Terminal arrangement

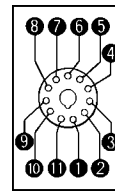

(Top view)

Mounting holes

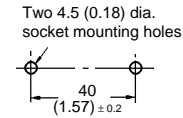

PL11 Panel mounting socket

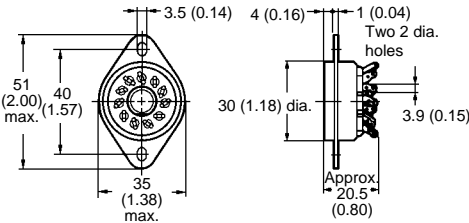

Terminal arrangement

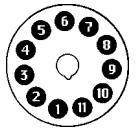

(Bottom view)

Mounting holes

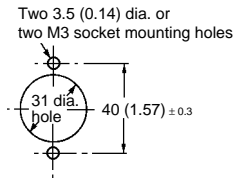

P3G-11 Back mounting socket

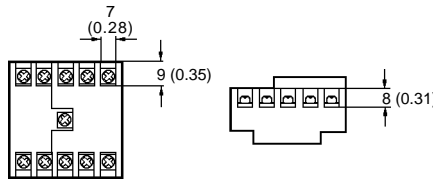
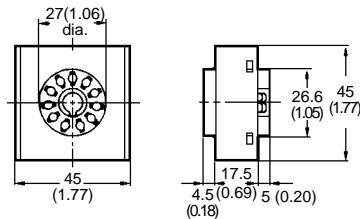

Terminal arrangement

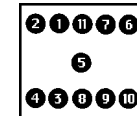

(Bottom view)

8-Pin Sockets for E2C-AM4A Amplifier

P2CF-08 Bottom surface or track mounting socket

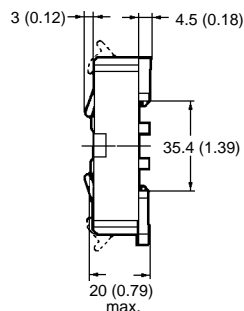
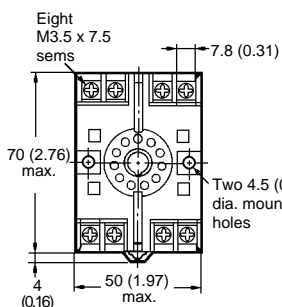

Terminal arrangement

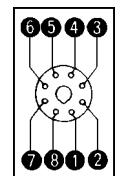

(Top view)

Mounting holes

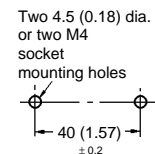

8-Pin Sockets for E2C-AM4A Amplifier (continued)

PL08 Panel mounting socket

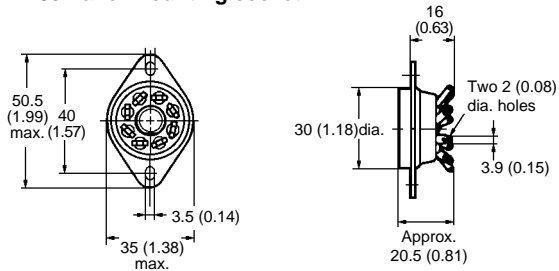

Terminal arrangement

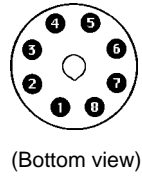

Mounting holes

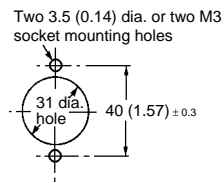

P3G-08 Back mounting socket

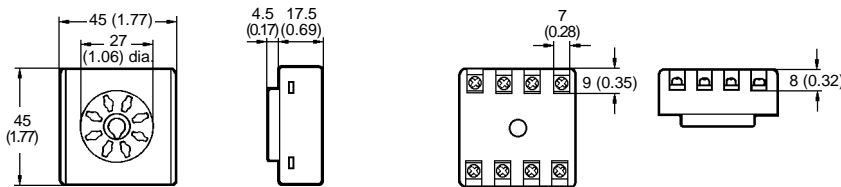

Terminal arrangement

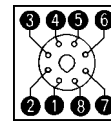

(Bottom view)

Sockets for E2C-G□4□ Amplifiers

PYF08A-E Bottom surface or track mounting socket

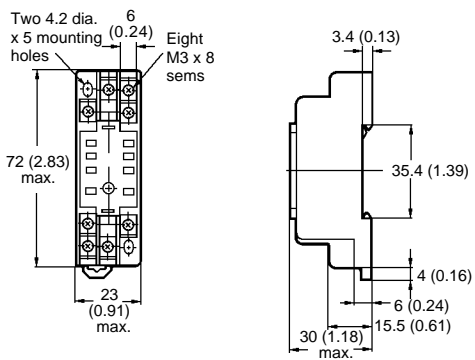

Terminal arrangement

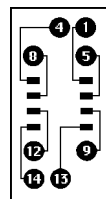

(Bottom view)

Mounting holes

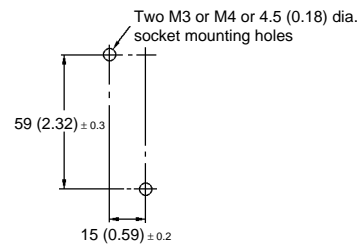

PY08 Panel mounting socket

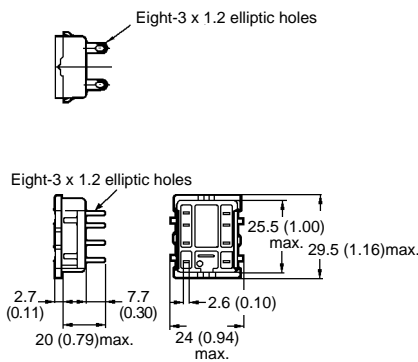

Terminal arrangement

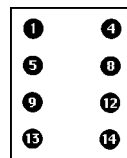

(Bottom view)

Panel cutout

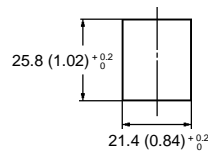

PYF08M Bottom surface mounting socket

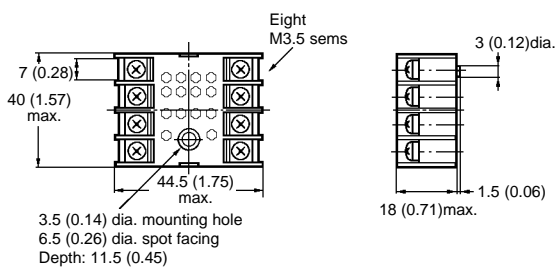

Terminal arrangement

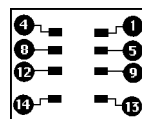

(Top view)

Mounting holes

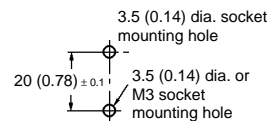

■ PANEL MOUNTING ADAPTERS

For E2C-A□4A Amplifiers

Y92F-30 Mounting adapter

Adapter installs behind the panel. It is ideal for side by side installation. Use P2CF-□□ sockets

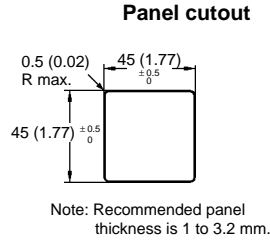
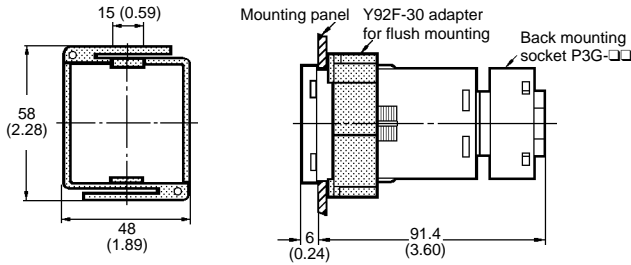

Y92F-70 Mounting adapter

Charcoal gray panel adapter installs through panel front. Amplifier face fits bezel, rear of amplifier clips to adapter. Use P3G-□□ sockets.

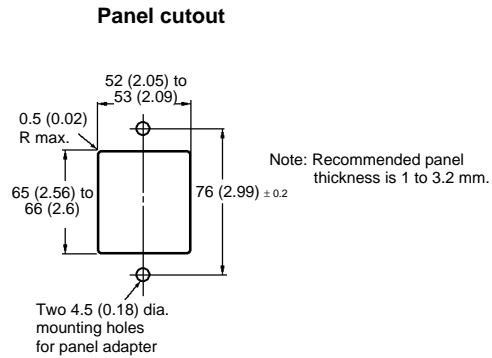
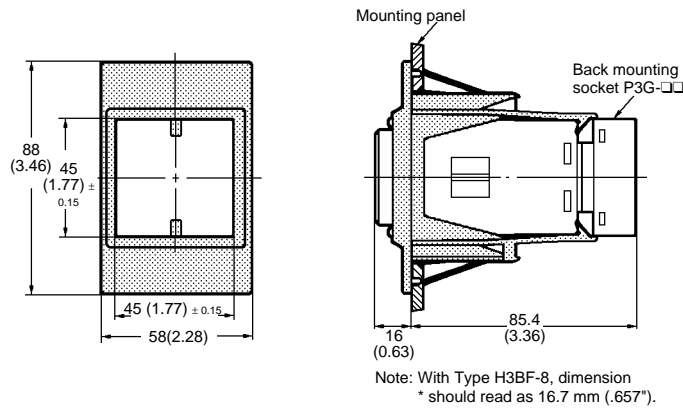

■ PROTECTIVE COVERS

For E2C-A□4A Amplifiers

Y92A-48 Hard plastic cover, Y92A-48D Soft plastic cover

Hard plastic cover Y92A-48 and soft plastic cover Y92A-48D snap onto the front of the amplifier to protect it from dust, dirt and water drip. The Y92A-48

hard plastic cover projects 4 mm from the front of the amplifier. Y92A-48D soft plastic cover fits snugly over the front.

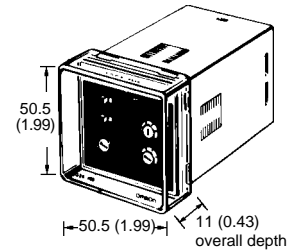

■ MOUNTING TRACK AND ACCESSORIES

PPF-100N/PPF-50N DIN Rail

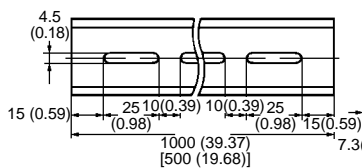

PPF-M End Plate

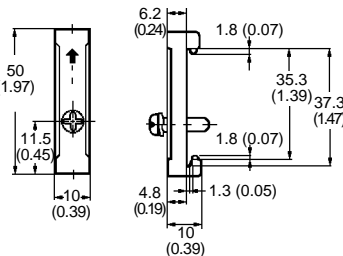

PPF-S Spacer

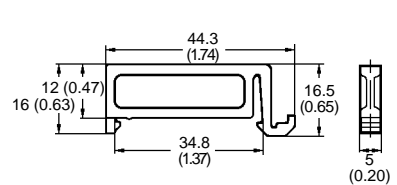



OMRON ELECTRONICS LLC
One East Commerce Drive
Schaumburg, IL 60173
1-800-55-OMRON

OMRON ON-LINE
Global - <http://www.omron.com>
USA - <http://www.omron.com/oei>
Canada - <http://www.omron.com/oci>

OMRON CANADA, INC.
885 Milner Avenue
Scarborough, Ontario M1B 5V8
416-286-6465