

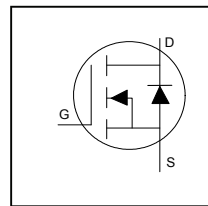
**Application**

- Brushed Motor drive applications
- BLDC Motor drive applications
- Battery powered circuits
- Half-bridge and full-bridge topologies
- Synchronous rectifier applications
- Resonant mode power supplies
- OR-ing and redundant power switches
- DC/DC and AC/DC converters
- DC/AC Inverters

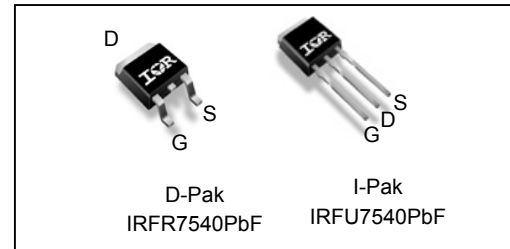
**Benefits**

- Improved Gate, Avalanche and Dynamic dV/dt Ruggedness
- Fully Characterized Capacitance and Avalanche SOA
- Enhanced body diode dV/dt and dI/dt Capability
- Lead-Free, RoHS Compliant

HEXFET® Power MOSFET

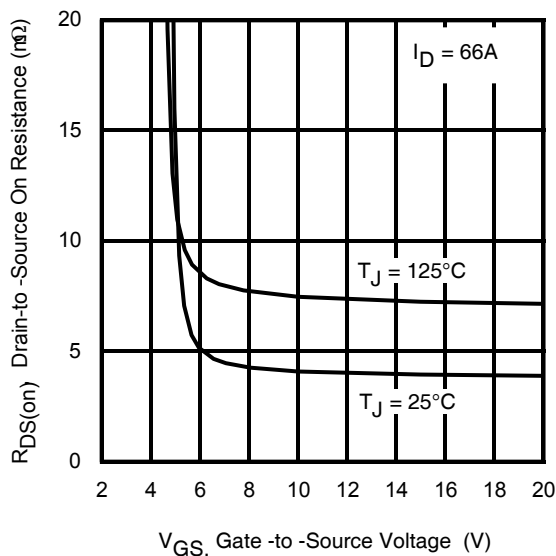


<b>V<sub>DSS</sub></b>	<b>60V</b>
<b>R<sub>DS(on)</sub> typ. max</b>	<b>4.0mΩ</b>
	<b>4.8mΩ</b>
<b>I<sub>D</sub> (Silicon Limited)</b>	<b>110A</b> Ⓢ
<b>I<sub>D</sub> (Package Limited)</b>	<b>90A</b>

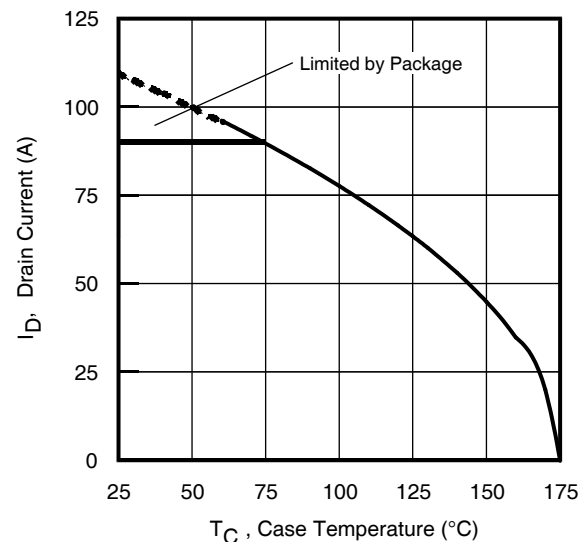


<b>G</b>	<b>D</b>	<b>S</b>
Gate	Drain	Source

Base part number	Package Type	Standard Pack		Orderable Part Number
		Form	Quantity	
IRFR7540PbF	D-Pak	Tube	75	IRFR7540PbF
		Tape and Reel	2000	IRFR7540TRPbF
		Tape and Reel Left	3000	IRFR7540TRLpbF
IRFU7540PbF	I-Pak	Tube	75	IRFU7540PbF



**Fig 1.** Typical On-Resistance vs. Gate Voltage



**Fig 2.** Maximum Drain Current vs. Case Temperature

**Absolute Maximum Rating**

Symbol	Parameter	Max.	Units
$I_D @ T_C = 25^\circ\text{C}$	Continuous Drain Current, $V_{GS} @ 10\text{V}$ (Silicon Limited)	110 <sup>①</sup>	A
$I_D @ T_C = 100^\circ\text{C}$	Continuous Drain Current, $V_{GS} @ 10\text{V}$ (Silicon Limited)	78	
$I_D @ T_C = 25^\circ\text{C}$	Continuous Drain Current, $V_{GS} @ 10\text{V}$ (Wire Bond Limited)	90	
$I_{DM}$	Pulsed Drain Current <sup>②</sup>	440*	
$P_D @ T_C = 25^\circ\text{C}$	Maximum Power Dissipation	140	W
	Linear Derating Factor	0.95	W/°C
$V_{GS}$	Gate-to-Source Voltage	$\pm 20$	V
$T_J$ $T_{STG}$	Operating Junction and Storage Temperature Range	-55 to + 175	°C
	Soldering Temperature, for 10 seconds (1.6mm from case)	300	

**Avalanche Characteristics**

$E_{AS}$ (Thermally limited)	Single Pulse Avalanche Energy <sup>③</sup>	160	mJ
$E_{AS}$ (Thermally limited)	Single Pulse Avalanche Energy <sup>⑩</sup>	273	
$I_{AR}$	Avalanche Current <sup>②</sup>	See Fig 15, 16, 23a, 23b	A
$E_{AR}$	Repetitive Avalanche Energy <sup>②</sup>		mJ

**Thermal Resistance**

Symbol	Parameter	Typ.	Max.	Units
$R_{\theta JC}$	Junction-to-Case <sup>⑧</sup>	—	1.05	°C/W
$R_{\theta JA}$	Junction-to-Ambient (PCB Mount) <sup>⑨</sup>	—	50	
$R_{\theta JA}$	Junction-to-Ambient	—	110	

**Static @  $T_J = 25^\circ\text{C}$  (unless otherwise specified)**

Symbol	Parameter	Min.	Typ.	Max.	Units	Conditions
$V_{(BR)DSS}$	Drain-to-Source Breakdown Voltage	60	—	—	V	$V_{GS} = 0\text{V}, I_D = 250\mu\text{A}$
$\Delta V_{(BR)DSS}/\Delta T_J$	Breakdown Voltage Temp. Coefficient	—	48	—	mV/°C	Reference to $25^\circ\text{C}, I_D = 1\text{mA}$ <sup>②</sup>
$R_{DS(on)}$	Static Drain-to-Source On-Resistance	—	4.0	4.8	mΩ	$V_{GS} = 10\text{V}, I_D = 66\text{A}$
		—	5.2	—		$V_{GS} = 6.0\text{V}, I_D = 33\text{A}$
$V_{GS(th)}$	Gate Threshold Voltage	2.1	—	3.7	V	$V_{DS} = V_{GS}, I_D = 100\mu\text{A}$
$I_{DSS}$	Drain-to-Source Leakage Current	—	—	1.0	μA	$V_{DS} = 60\text{V}, V_{GS} = 0\text{V}$
		—	—	150		$V_{DS} = 60\text{V}, V_{GS} = 0\text{V}, T_J = 125^\circ\text{C}$
$I_{GSS}$	Gate-to-Source Forward Leakage	—	—	100	nA	$V_{GS} = 20\text{V}$
	Gate-to-Source Reverse Leakage	—	—	-100		$V_{GS} = -20\text{V}$
$R_G$	Gate Resistance	—	2.4	—	Ω	

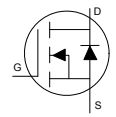
**Notes:**

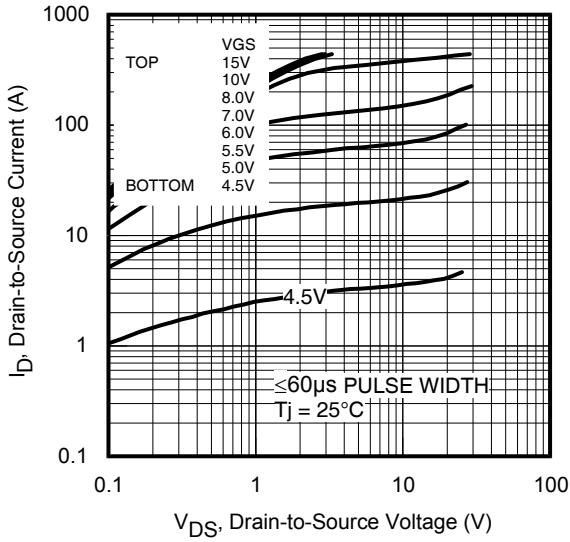
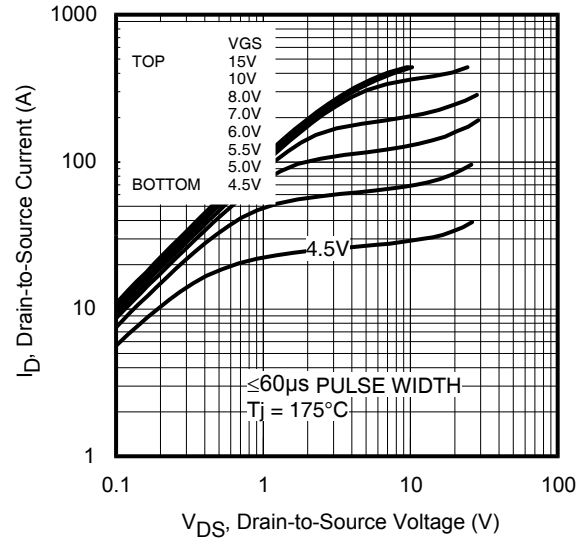
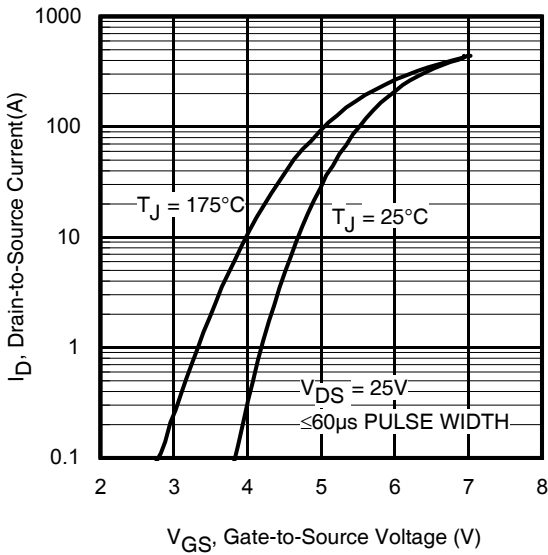
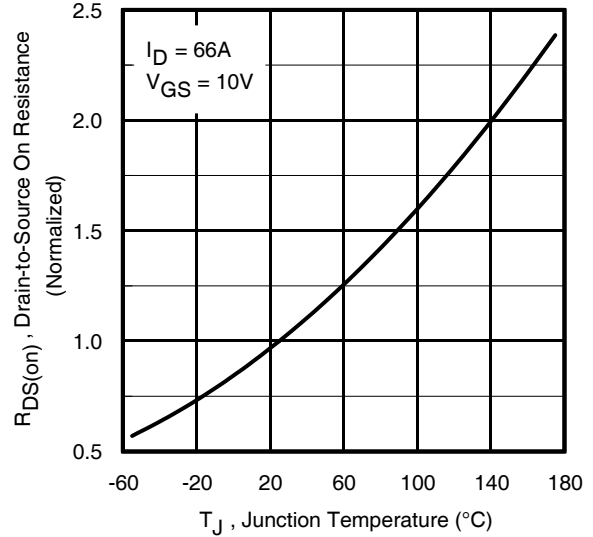
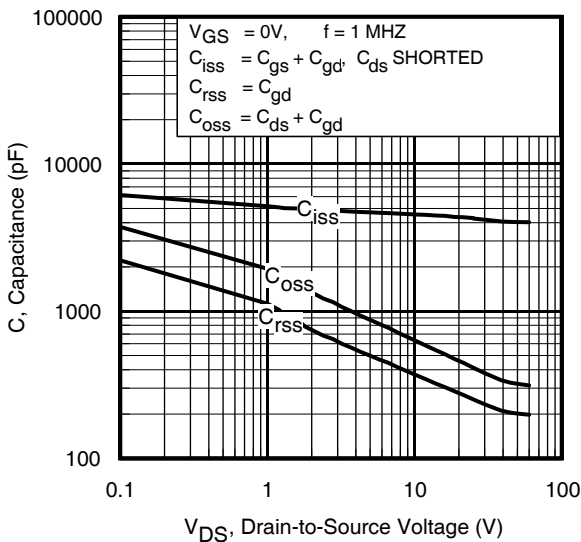
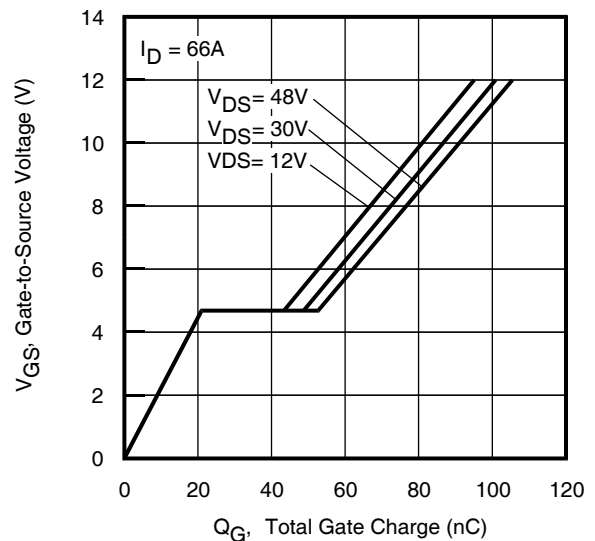
- ① Calculated continuous current based on maximum allowable junction temperature. Bond wire current limit is 90A by source bonding technology. Note that current limitations arising from heating of the device leads may occur with some lead mounting arrangements. (Refer to AN-1140)
  - ② Repetitive rating; pulse width limited by max. junction temperature.
  - ③ Limited by  $T_{Jmax}$ , starting  $T_J = 25^\circ\text{C}$ ,  $L = 72\mu\text{H}$ ,  $R_G = 50\Omega$ ,  $I_{AS} = 66\text{A}$ ,  $V_{GS} = 10\text{V}$ .
  - ④  $I_{SD} \leq 66\text{A}$ ,  $di/dt \leq 1190\text{A}/\mu\text{s}$ ,  $V_{DD} \leq V_{(BR)DSS}$ ,  $T_J \leq 175^\circ\text{C}$ .
  - ⑤ Pulse width  $\leq 400\mu\text{s}$ ; duty cycle  $\leq 2\%$ .
  - ⑥  $C_{oss}$  eff. (TR) is a fixed capacitance that gives the same charging time as  $C_{oss}$  while  $V_{DS}$  is rising from 0 to 80%  $V_{DSS}$ .
  - ⑦  $C_{oss}$  eff. (ER) is a fixed capacitance that gives the same energy as  $C_{oss}$  while  $V_{DS}$  is rising from 0 to 80%  $V_{DSS}$ .
  - ⑧  $R_{\theta}$  is measured at  $T_J$  approximately  $90^\circ\text{C}$ .
  - ⑨ When mounted on 1" square PCB (FR-4 or G-10 Material). For recommended footprint and soldering techniques refer to application note #AN-994. please refer to application note to AN-994: <http://www.irf.com/technical-info/appnotes/an-994.pdf>
  - ⑩ Limited by  $T_{Jmax}$ , starting  $T_J = 25^\circ\text{C}$ ,  $L = 1\text{mH}$ ,  $R_G = 50\Omega$ ,  $I_{AS} = 23\text{A}$ ,  $V_{GS} = 10\text{V}$ .
- \* Pulse drain current is limited at 360A by source bonding technology.

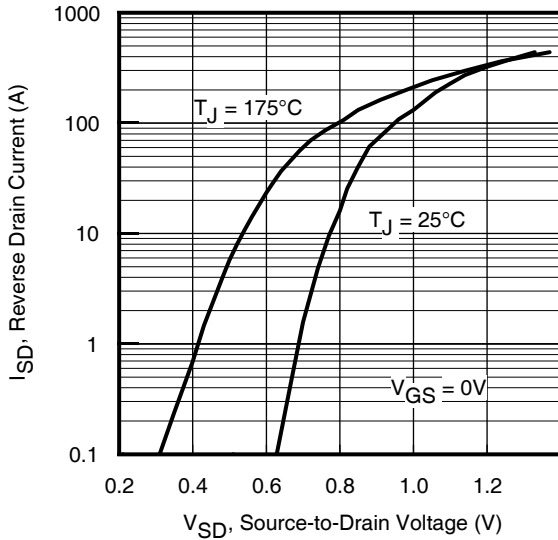
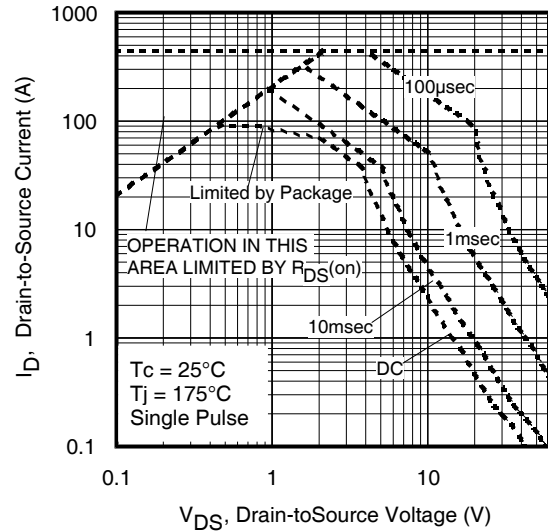
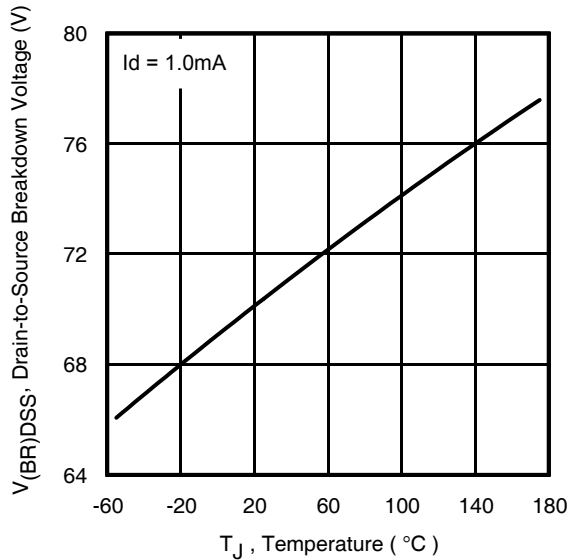
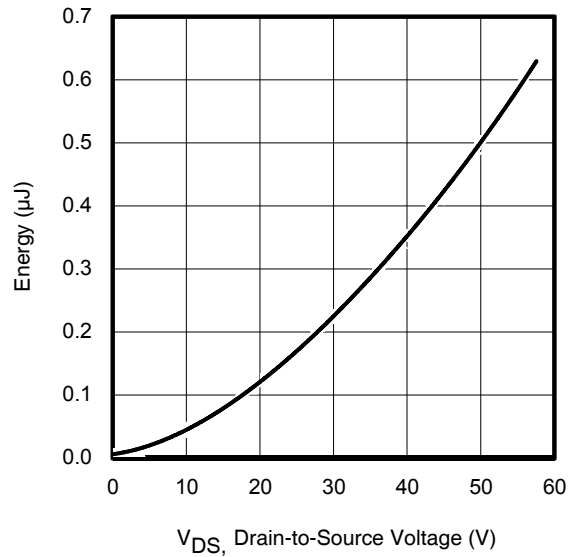
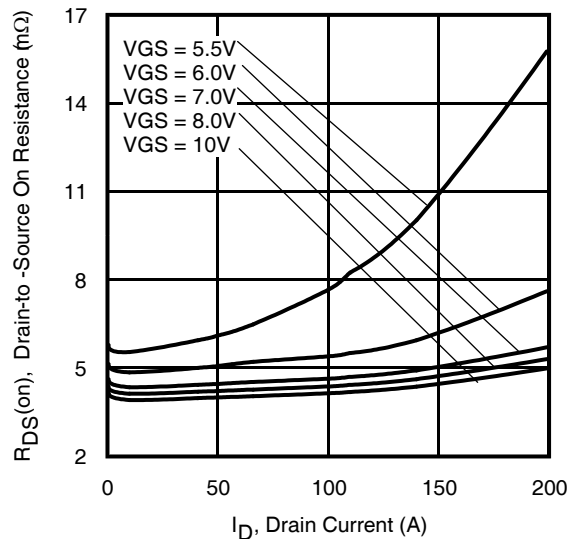
**Dynamic Electrical Characteristics @ T<sub>J</sub> = 25°C (unless otherwise specified)**

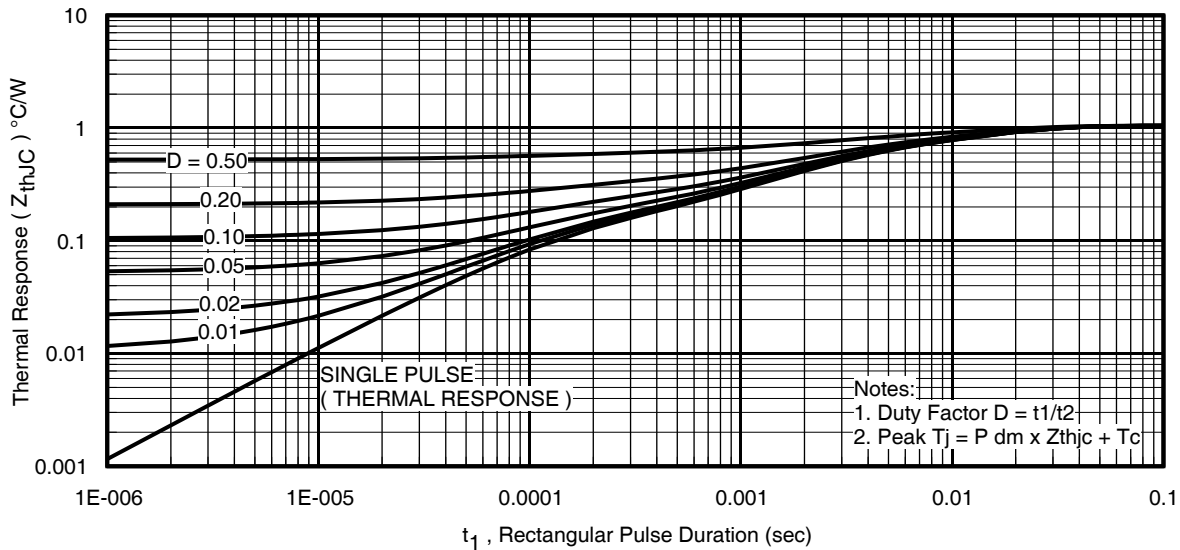
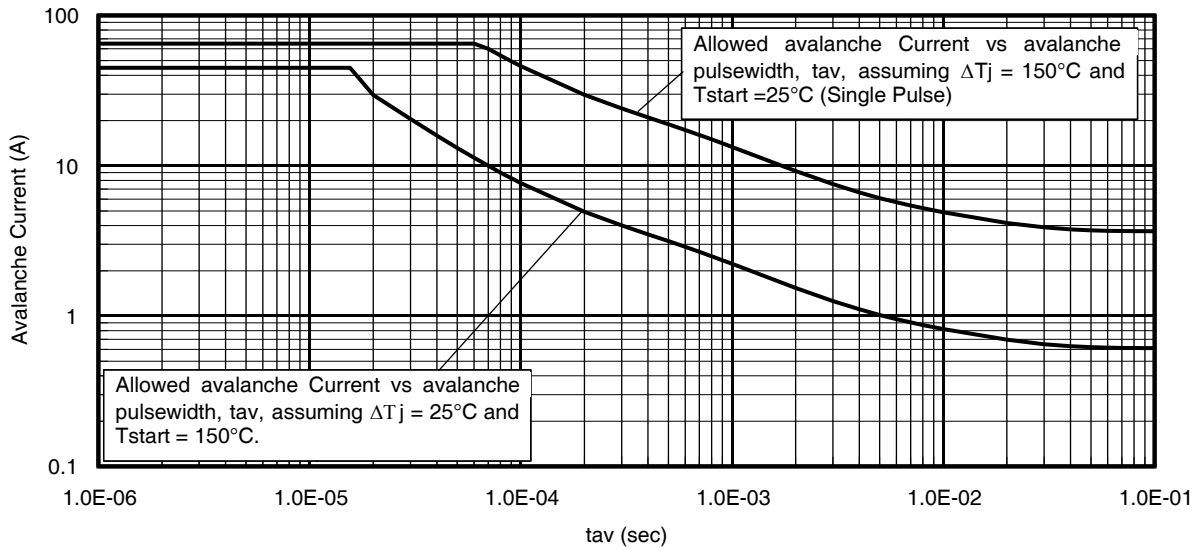
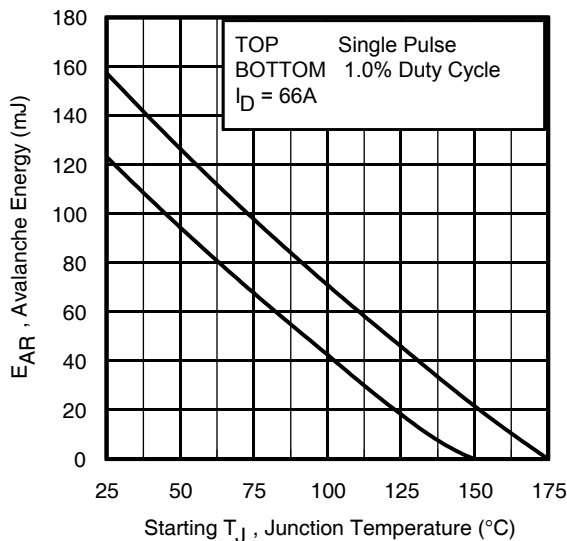
Symbol	Parameter	Min.	Typ.	Max.	Units	Conditions
g <sub>fs</sub>	Forward Transconductance	200	—	—	S	V <sub>DS</sub> = 10V, I <sub>D</sub> = 66A
Q <sub>g</sub>	Total Gate Charge	—	86	130	nC	I <sub>D</sub> = 66A V <sub>DS</sub> = 30V V <sub>GS</sub> = 10V
Q <sub>gs</sub>	Gate-to-Source Charge	—	22	—		
Q <sub>gd</sub>	Gate-to-Drain Charge	—	27	—		
Q <sub>sync</sub>	Total Gate Charge Sync. (Q <sub>g</sub> – Q <sub>gd</sub> )	—	59	—		
t <sub>d(on)</sub>	Turn-On Delay Time	—	8.7	—	ns	V <sub>DD</sub> = 30V I <sub>D</sub> = 66A R <sub>G</sub> = 2.7Ω V <sub>GS</sub> = 10V <sup>⑤</sup>
t <sub>r</sub>	Rise Time	—	38	—		
t <sub>d(off)</sub>	Turn-Off Delay Time	—	59	—		
t <sub>f</sub>	Fall Time	—	32	—		
C <sub>iss</sub>	Input Capacitance	—	4360	—	pF	V <sub>GS</sub> = 0V V <sub>DS</sub> = 25V f = 1.0MHz, See Fig.7 V <sub>GS</sub> = 0V, V <sub>DS</sub> = 0V to 48V <sup>⑦</sup> V <sub>GS</sub> = 0V, V <sub>DS</sub> = 0V to 48V <sup>⑥</sup>
C <sub>oss</sub>	Output Capacitance	—	410	—		
C <sub>riss</sub>	Reverse Transfer Capacitance	—	260	—		
C <sub>oss eff.(ER)</sub>	Effective Output Capacitance (Energy Related)	—	410	—		
C <sub>oss eff.(TR)</sub>	Output Capacitance (Time Related)	—	530	—		

**Diode Characteristics**

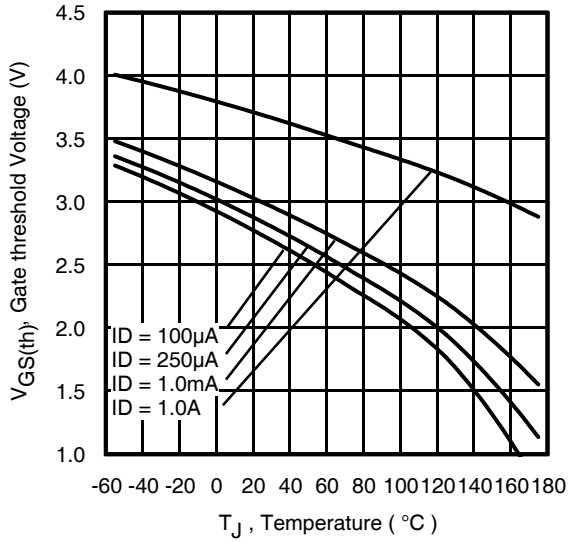
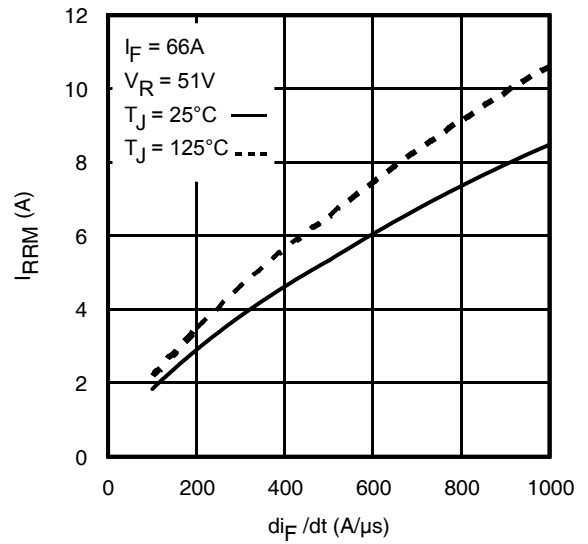
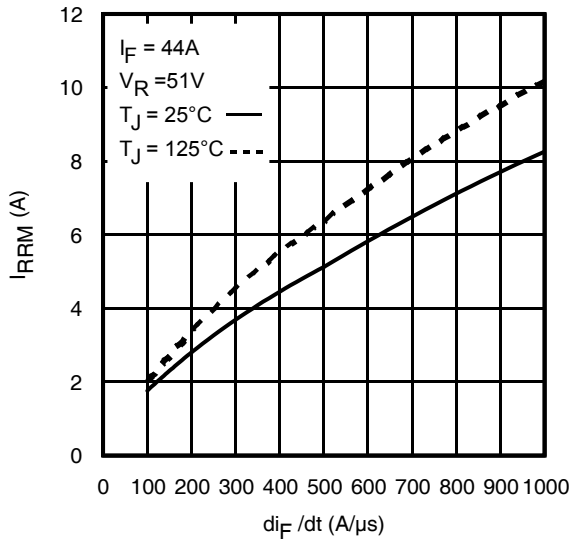
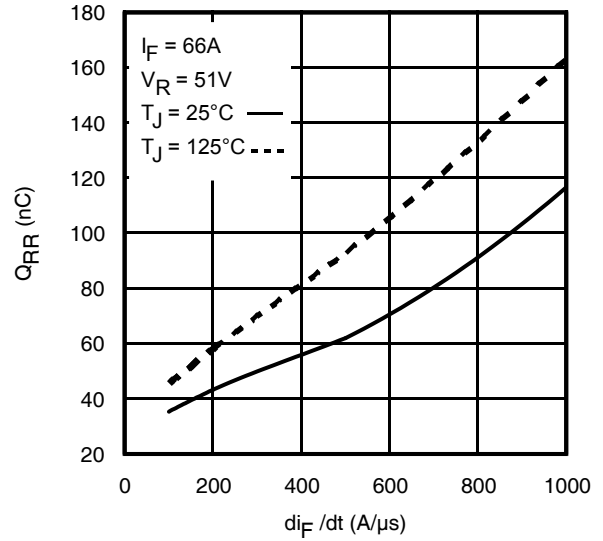
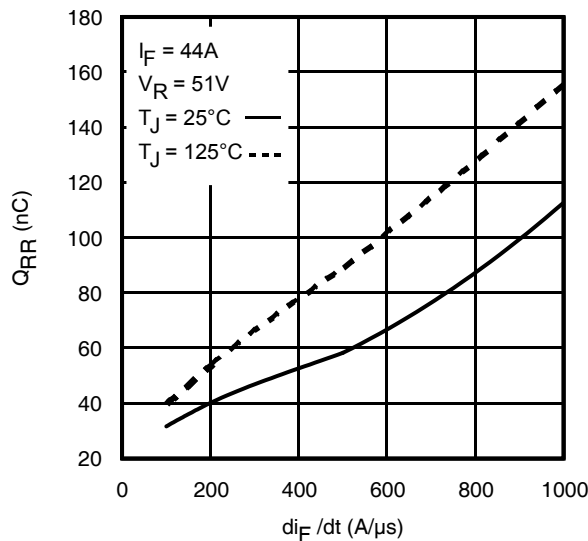
Symbol	Parameter	Min.	Typ.	Max.	Units	Conditions
I <sub>S</sub>	Continuous Source Current (Body Diode)	—	—	110 <sup>①</sup>	A	MOSFET symbol showing the integral reverse p-n junction diode. 
I <sub>SM</sub>	Pulsed Source Current (Body Diode) <sup>②</sup>	—	—	440*		
V <sub>SD</sub>	Diode Forward Voltage	—	—	1.2	V	T <sub>J</sub> = 25°C, I <sub>S</sub> = 66A, V <sub>GS</sub> = 0V <sup>③</sup>
dv/dt	Peak Diode Recovery dv/dt <sup>④</sup>	—	11	—	V/ns	T <sub>J</sub> = 175°C, I <sub>S</sub> = 66A, V <sub>DS</sub> = 60V
t <sub>rr</sub>	Reverse Recovery Time	—	34	—	ns	T <sub>J</sub> = 25°C V <sub>DD</sub> = 51V
		—	37	—		T <sub>J</sub> = 125°C I <sub>F</sub> = 66A,
Q <sub>rr</sub>	Reverse Recovery Charge	—	36	—	nC	T <sub>J</sub> = 25°C di/dt = 100A/μs <sup>⑤</sup>
		—	47	—		T <sub>J</sub> = 125°C
I <sub>RRM</sub>	Reverse Recovery Current	—	1.9	—	A	T <sub>J</sub> = 25°C

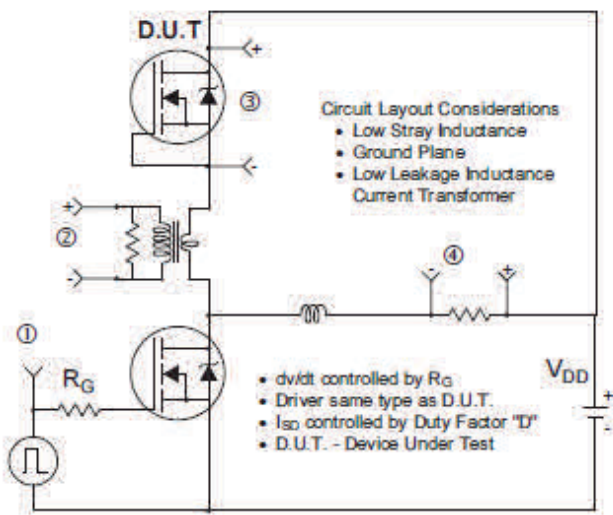

**Fig 3. Typical Output Characteristics**

**Fig 4. Typical Output Characteristics**

**Fig 5. Typical Transfer Characteristics**

**Fig 6. Normalized On-Resistance vs. Temperature**

**Fig 7. Typical Capacitance vs. Drain-to-Source Voltage**

**Fig 8. Typical Gate Charge vs. Gate-to-Source Voltage**


**Fig 9.** Typical Source-Drain Diode Forward Voltage

**Fig 10.** Maximum Safe Operating Area

**Fig 11.** Drain-to-Source Breakdown Voltage

**Fig 12.** Typical  $C_{oss}$  Stored Energy

**Fig 13.** Typical On-Resistance vs. Drain Current

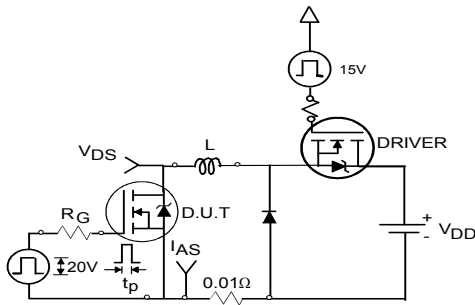

**Fig 14. Maximum Effective Transient Thermal Impedance, Junction-to-Case**

**Fig 15. Avalanche Current vs. Pulse Width**

**Fig 16. Maximum Avalanche Energy vs. Temperature**
**Notes on Repetitive Avalanche Curves , Figures 15, 16:  
(For further info, see AN-1005 at www.irf.com)**

1. Avalanche failures assumption:  
Purely a thermal phenomenon and failure occurs at a temperature far in excess of  $T_{jmax}$ . This is validated for every part type.
2. Safe operation in Avalanche is allowed as long as  $T_{jmax}$  is not exceeded.
3. Equation below based on circuit and waveforms shown in Figures 23a, 23b.
4.  $P_{D(ave)}$  = Average power dissipation per single avalanche pulse.
5. BV = Rated breakdown voltage (1.3 factor accounts for voltage increase during avalanche).
6.  $I_{av}$  = Allowable avalanche current.
7.  $\Delta T$  = Allowable rise in junction temperature, not to exceed  $T_{jmax}$  (assumed as  $25^\circ\text{C}$  in Figure 14, 15).  
 $t_{av}$  = Average time in avalanche.  
 $D$  = Duty cycle in avalanche =  $t_{av} \cdot f$   
 $Z_{thJC}(D, t_{av})$  = Transient thermal resistance, see Figures 13)  
 $P_{D(ave)} = 1/2 (1.3 \cdot BV \cdot I_{av}) = \Delta T / Z_{thJC}$   
 $I_{av} = 2\Delta T / [1.3 \cdot BV \cdot Z_{th}]$   
 $E_{AS(AR)} = P_{D(ave)} \cdot t_{av}$

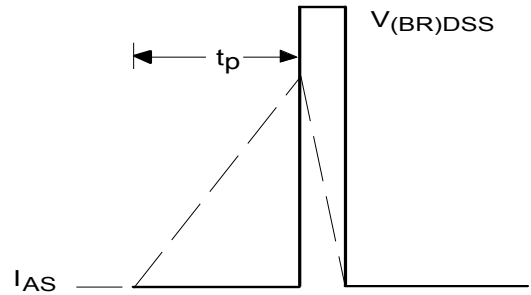

**Fig 17.** Threshold Voltage vs. Temperature

**Fig 18.** Typical Recovery Current vs.  $di_F/dt$ 

**Fig 19.** Typical Recovery Current vs.  $di_F/dt$ 

**Fig 20.** Typical Stored Charge vs.  $di_F/dt$ 

**Fig 21.** Typical Stored Charge vs.  $di_F/dt$



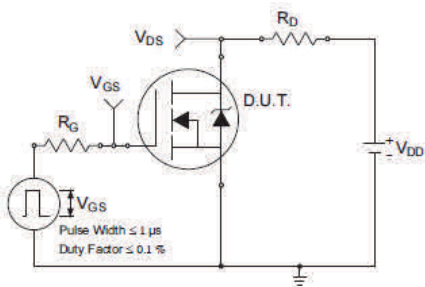
**Fig 22.** Peak Diode Recovery  $dV/dt$  Test Circuit for N-Channel HEXFET<sup>®</sup> Power MOSFETs



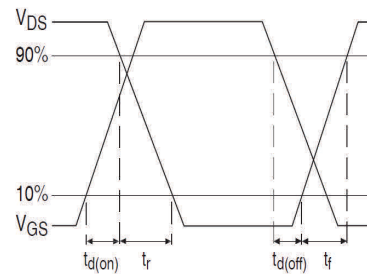
**Fig 23a.** Unclamped Inductive Test Circuit



**Fig 23b.** Unclamped Inductive Waveforms



**Fig 24a.** Switching Time Test Circuit



**Fig 24b.** Switching Time Waveforms

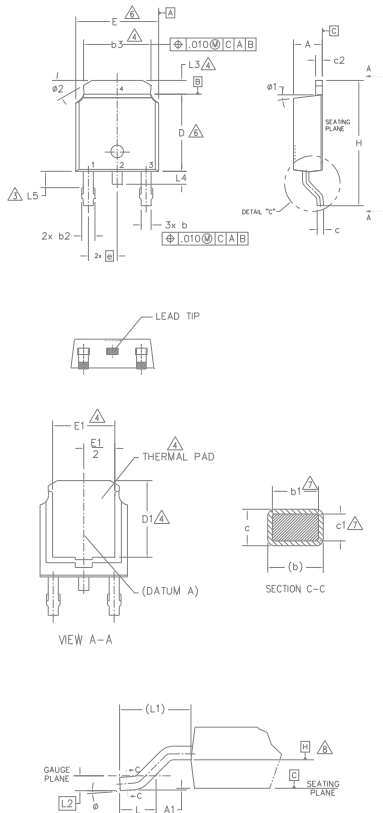


**Fig 25a.** Gate Charge Test Circuit



**Fig 25b.** Gate Charge Waveform



**D-Pak (TO-252AA) Package Outline Dimensions are shown in millimeters (inches)**

**NOTES:**

- 1.- DIMENSIONING AND TOLERANCING PER ASME Y14.5M-1994
- 2.- DIMENSIONS ARE SHOWN IN INCHES [MILLIMETERS]
- △- LEAD DIMENSION UNCONTROLLED IN L5.
- △- DIMENSION D1, E1, L3 & b3 ESTABLISH A MINIMUM MOUNTING SURFACE FOR THERMAL PAD.
- 5.- SECTION C-C DIMENSIONS APPLY TO THE FLAT SECTION OF THE LEAD BETWEEN .005 AND 0.10 [0.13 AND 0.25] FROM THE LEAD TIP.
- △- DIMENSION D & E DO NOT INCLUDE MOLD FLASH. MOLD FLASH SHALL NOT EXCEED .006 [0.15] PER SIDE. THESE DIMENSIONS ARE MEASURED AT THE OUTMOST EXTREMES OF THE PLASTIC BODY.
- △- DIMENSION b1 & c1 APPLIED TO BASE METAL ONLY.
- △- DATUM A & B TO BE DETERMINED AT DATUM PLANE H.
- 9.- OUTLINE CONFORMS TO JEDEC OUTLINE TO-252AA.

SYMBOL	DIMENSIONS				NOTES
	MILLIMETERS		INCHES		
	MIN.	MAX.	MIN.	MAX.	
A	2.18	2.39	.086	.094	
A1	-	0.13	-	.005	
b	0.64	0.89	.025	.035	
b1	0.64	0.79	.025	.031	7
b2	0.76	1.14	.030	.045	
b3	4.95	5.46	.195	.215	4
c	0.46	0.61	.018	.024	
c1	0.41	0.56	.016	.022	7
c2	0.46	0.89	.018	.035	
D	5.97	6.22	.235	.245	6
D1	5.21	-	.205	-	4
E	6.35	6.73	.250	.265	6
E1	4.32	-	.170	-	4
e	2.29 BSC		.090 BSC		
H	9.40	10.41	.370	.410	
L	1.40	1.78	.055	.070	
L1	2.74 BSC		.108 REF.		
L2	0.51 BSC		.020 BSC		
L3	0.89	1.27	.035	.050	4
L4	-	1.02	-	.040	
L5	1.14	1.52	.045	.060	3
φ	0"	10"	0"	10"	
φ1	0"	15"	0"	15"	
φ2	25"	35"	25"	35"	

**LEAD ASSIGNMENTS**
**HEXFET**

- 1.- GATE
- 2.- DRAIN
- 3.- SOURCE
- 4.- DRAIN

**IGBT & CoPAK**

- 1.- GATE
- 2.- COLLECTOR
- 3.- EMITTER
- 4.- COLLECTOR

**D-Pak (TO-252AA) Part Marking Information**

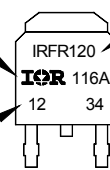
EXAMPLE: THIS IS AN IRFR120  
WITH ASSEMBLY  
LOT CODE 1234  
ASSEMBLED ON WW 16, 2001  
IN THE ASSEMBLY LINE "A"

Note: "P" in assembly line position  
indicates "Lead-Free"

"P" in assembly line position indicates  
"Lead-Free" qualification to the consumer-level

INTERNATIONAL  
RECTIFIER  
LOGO

ASSEMBLY  
LOT CODE



PART NUMBER

DATE CODE  
YEAR 1 = 2001  
WEEK 16  
LINE A

OR

INTERNATIONAL  
RECTIFIER  
LOGO

ASSEMBLY  
LOT CODE

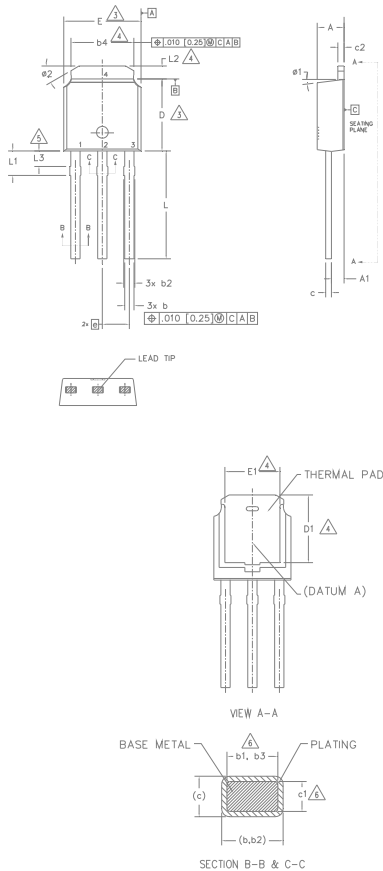


PART NUMBER

DATE CODE  
P = DESIGNATES LEAD-FREE  
PRODUCT (OPTIONAL)  
P̄ = DESIGNATES LEAD-FREE  
PRODUCT QUALIFIED TO THE  
CONSUMER LEVEL (OPTIONAL)

YEAR 1 = 2001  
WEEK 16  
A = ASSEMBLY SITE CODE

Note: For the most current drawing please refer to IR website at <http://www.irf.com/package/>

**I-Pak (TO-251AA) Package Outline Dimensions are shown in millimeters (inches)**

**NOTES:**

- 1.- DIMENSIONING AND TOLERANCING PER ASME Y14.5M-1994
- 2.- DIMENSION ARE SHOWN IN INCHES [MILLIMETERS].
- 3.- DIMENSION D & E DO NOT INCLUDE MOLD FLASH. MOLD FLASH SHALL NOT EXCEED .005 [0.13] PER SIDE. THESE DIMENSIONS ARE MEASURED AT THE OUTMOST EXTREMES OF THE PLASTIC BODY.
- 4.- THERMAL PAD CONTOUR OPTION WITHIN DIMENSION b4, L2, E1 & D1.
- 5.- LEAD DIMENSION UNCONTROLLED IN L3.
- 6.- DIMENSION b1, b3 & c1 APPLY TO BASE METAL ONLY.
- 7.- OUTLINE CONFORMS TO JEDEC OUTLINE TO-251AA (Date 06/02).
- 8.- CONTROLLING DIMENSION : INCHES.

SYMBOL	DIMENSIONS				NOTES
	MILLIMETERS		INCHES		
	MIN.	MAX.	MIN.	MAX.	
A	2.18	2.39	.086	.094	
A1	0.89	1.14	.035	.045	
b	0.64	0.89	.025	.035	
b1	0.65	0.79	.025	.031	6
b2	0.76	1.14	.030	.045	
b3	0.76	1.04	.030	.041	6
b4	4.95	5.46	.195	.215	4
c	0.46	0.61	.018	.024	
c1	0.41	0.56	.016	.022	6
c2	0.46	0.89	.018	.035	
D	5.97	6.22	.235	.245	3
D1	5.21	-	.205	-	4
E	6.35	6.73	.250	.265	3
E1	4.32	-	.170	-	4
e	2.29 BSC		.090 BSC		
L	8.89	9.65	.350	.380	
L1	1.91	2.29	.045	.090	
L2	0.89	1.27	.035	.050	4
L3	0.89	1.52	.035	.060	5
Ø1	0"	15"	0"	15"	
Ø2	25"	35"	25"	35"	

**LEAD ASSIGNMENTS**
**HEXFET**

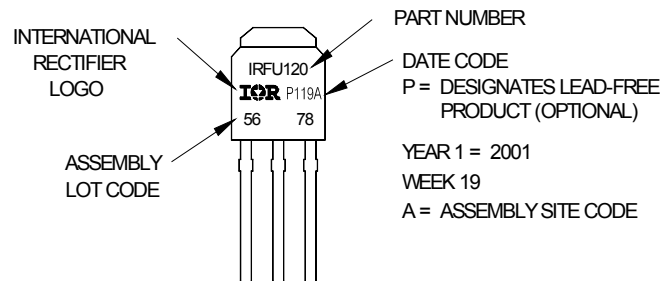
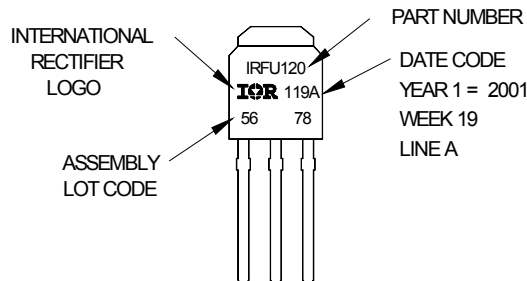
- 1.- GATE
- 2.- DRAIN
- 3.- SOURCE
- 4.- DRAIN

**I-Pak (TO-251AA) Part Marking Information**

EXAMPLE: THIS IS AN IRFU120  
WITH ASSEMBLY  
LOT CODE 5678  
ASSEMBLED ON WW 19, 2001  
IN THE ASSEMBLY LINE "A"

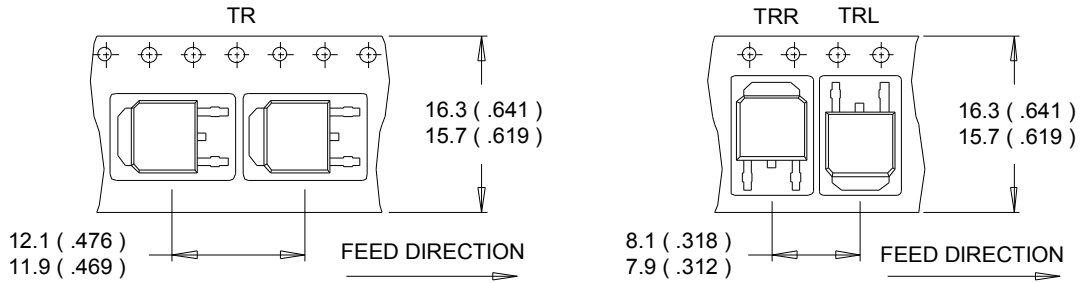
Note: "P" in assembly line position  
indicates Lead-Free"

**OR**



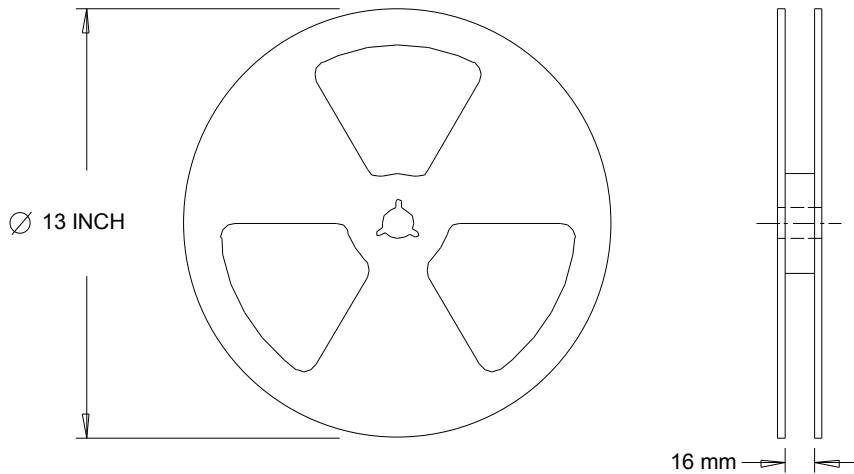
Note: For the most current drawing please refer to IR website at <http://www.irf.com/package/>

D-Pak (TO-252AA) Tape & Reel Information Dimensions are shown in millimeters (inches)



**NOTES :**

1. CONTROLLING DIMENSION : MILLIMETER.
2. ALL DIMENSIONS ARE SHOWN IN MILLIMETERS ( INCHES ).
3. OUTLINE CONFORMS TO EIA-481 & EIA-541.



**NOTES :**

1. OUTLINE CONFORMS TO EIA-481.

Note: For the most current drawing please refer to IR website at <http://www.irf.com/package/>

**Qualification Information<sup>†</sup>**

<b>Qualification Level</b>	Industrial (per JEDEC JESD47F) <sup>††</sup>	
<b>Moisture Sensitivity Level</b>	D-Pak	MSL1
	I-Pak	N/A
<b>RoHS Compliant</b>	Yes	

† Qualification standards can be found at International Rectifier's web site: <http://www.irf.com/product-info/reliability/>

†† Applicable version of JEDEC standard at the time of product release.

**Revision History**

<b>Date</b>	<b>Comment</b>
11/5/2014	<ul style="list-style-type: none"> <li>• Updated <math>E_{AS(L=1mH)} = 273mJ</math> on page 2</li> <li>• Updated note 10 "Limited by <math>T_{Jmax}</math>, starting <math>T_J = 25^{\circ}C</math>, <math>L = 1mH</math>, <math>R_G = 50\Omega</math>, <math>I_{AS} = 23A</math>, <math>V_{GS} = 10V</math>". on page 2</li> <li>• Updated package outline on page 9 &amp; 10</li> </ul>
12/17/2014	<ul style="list-style-type: none"> <li>• Added "IRFR7540TRLpBf" in orderable part number on page 1.</li> </ul>