



REED SWITCHES

Technical & Applications Information

07082013

SWITCH TECHNICAL & APPLICATIONS INFORMATION

REED SWITCH PACKAGING

Standard packaging for uncut Reed Switches is a box containing 500 pieces. Standard packaging for SMD Reed Switches is Tape & Reel. Special trays and/or Tape & Reel are available for some types.

Contact your local Coto Technology Representative with your special packaging needs. Below is a chart of Tape & Reel dimensions for standard products.

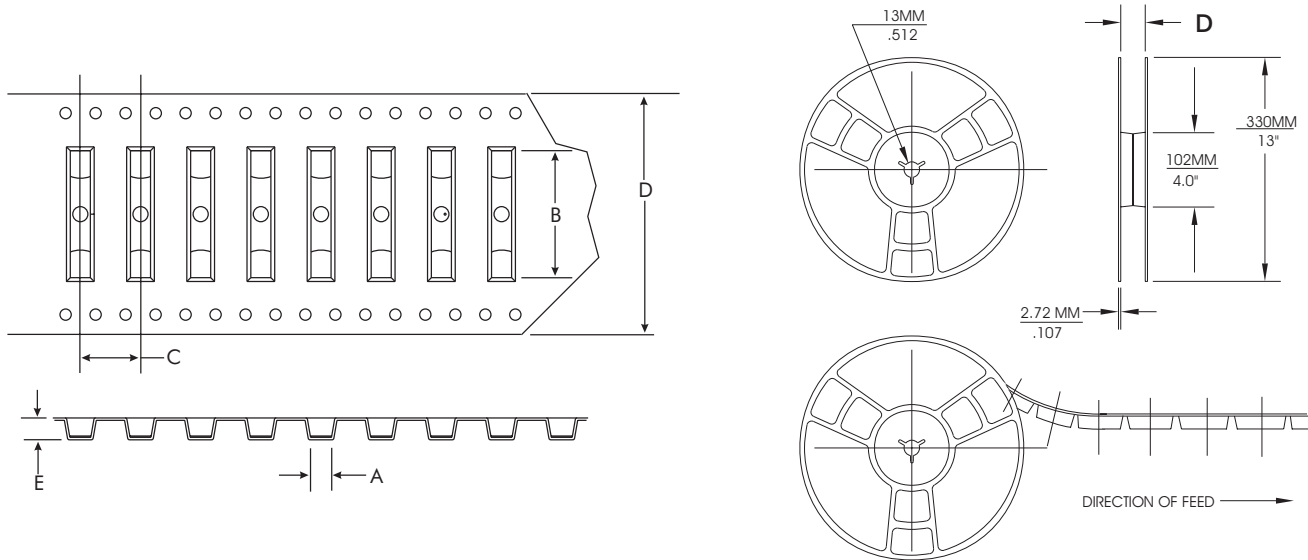

Series	A	B	C	D	E	Std. Qty/Reel
CT05 G1	2.57	10.92	8.00	24.00	2.59	2000
CT05 "J1"	2.57	8.64	8.00	16.00	2.59	2000
CT10 A2, G1	2.68	16.90	8.00	32.00	3.30	2000
CT10 G2	3.00	19.80	8.00	32.00	3.12	2000
CT10 G4	3.00	19.80	8.00	32.00	3.12	2000

(Dimensions in Millimeters)

Recommended Pad Layouts for SMD Reed Relay Switches

Model	Lead Type	Fig. #	Dim. A	Dim. B	Dim. C	Dim. D
CT05	G1	1	.424/10.76	.242/6.14	.091/2.31	.057/1.45
CT05	"J1"	1	.330/8.38	.168/4.27	.081/2.06	.057/1.45
CT10	A2	1	.666/16.92	.529/13.44	.069/1.74	.050/1.27
CT10	G1	1	.692/17.57	.520/13.20	.086/2.18	.041/1.04
CT10	G2	1	.822/20.87	.640/16.25	.091/2.31	.057/1.45
CT10	G4	1	.822/20.87	.640/16.25	.091/2.31	.057/1.45

(Dimensions in Inches/Millimeters)

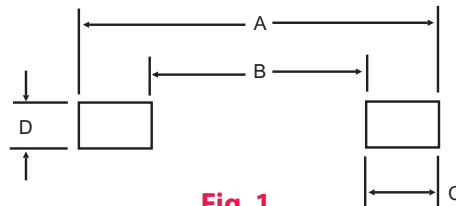

Fig. 1

GLOSSARY OF TERMS

Dry-Reed Switch: A dry-reed switch is an assembly containing ferromagnetic contact blades, hermetically sealed in a glass envelope and operated by an externally-generated magnetic field, e.g., that from an actuating coil.

Operate Value: The ampere turn value at which normally-open contacts close. Lower value reflects higher sensitivity.

Operate Time: The operate time is the time between the instant of application of a magnetic field to a dry-reed switch and the instant of the first physical closing of this switch. The operate time does not include bounce time.

Release Value: The ampere turn value at which normally-open contacts, held closed by a magnetic field, will reopen as field strength is reduced.

Release Time: The release time is the time between the instant of removal of an applied magnetic field to a dry-reed switch and the instant of the first physical opening of this switch. The release time does not include bounce time.

Bounce: Bounce is a momentary opening of a switch after initial closing, or a momentary closing after initial opening.

Bounce Time: The bounce time is the interval of time between the instant of initial closing (or opening) and the instant of final closing (or opening) of the dry-reed switch.

Dry-Reed Switch Contact Resistance: The dry-reed switch contact resistance is the resistance of the dry-reed switch under specified conditions of measurement.

Saturate Value: The saturate value is defined as the value of the applied magnetic field at which the dry-reed switch is unaffected by further increase of the applied magnetic field.

SWITCH TECHNICAL & APPLICATIONS INFORMATION

REED SWITCH CHARACTERISTICS

Operate and Release Values

Operate and release values are dependent on the measuring coil, the rate of energization (0.1 AT/ms), the detection of the operate (closing) and the release (opening) moment, the position of the measuring coil relative to the earth's magnetic field and on the environmental conditions.

Operate and Release Times

The operate and release times are dependent mostly on the energization and de-energization rate. They are proportional to the R/L time of the coil. Operate time is inversely proportional to the ratio of energization to operate value. Release time is proportional to the ratio of energization to release value.

Bounce Time

The bounce time is almost independent of the energization, however, a high energization gives a somewhat shorter bounce time. The bounce time is dependent on the current to be switched; above approximately 100 mA the bounce time is almost zero.

Contact Resistance

The contact resistance is dependent on the wire composition, wire diameter, energization and contact layer. The published contact resistance is measured with an open contact voltage of 20 mV and a current through the closed contacts of 10 mA, using the 4-point method (Kelvin method). Distance between measuring points for all switch types is 41 mm.

Breakdown Voltage

The breakdown voltage depends on the gap between the contact blades, kind of gas filling, gas pressure, material of the contact layer and the availability of free electrons in the gas. The first three items are set by the design of a particular reed switch. The last item is very dependent on ambient conditions. Therefore minimum values are given in the published data.

Insulation Resistance

The insulation resistance is dependent on the condition of the inside of the glass envelope and on the environment, e.g. relative humidity, conducting layers on the outside of the glass envelope.

Life Expectancy

The life of a dry-reed switch is influenced by the contact layer, the mechanical characteristics of the reed switch blade, the load, the load circuit parameters and the applied magnetic field. The contact layer and the blade characteristics are determined by the manufacturer. Load, load circuit parameters and magnetic field are determined by the user. The load should be within the maximum published values. The load circuit parameters (wiring capacitance and inductance), should be kept as low as possible and the applied magnetic field must be stronger than necessary for obtaining the maximum operate value.

Remark: Due to the influence of the load circuit on contact resistance and sticking, and also the influence of the applied magnetic field and used coil or magnet, life-test information can only be compared when it is the result of testing under exactly the same conditions (test equipment).

Coils:

The electrical characteristics are measured using either the NARM1 coil or the 10JK coil. Using another coil may change these characteristics. The measuring method e.g. speed, detection and the position of the coil with respect to the earth's magnetic field may also affect the characteristics. The definitions of the NARM1 coil and the 10JK coil are as follows:

10JK Coil: 10000 turns of 47 SWG single enameled copper wire on an elliptical coil former of 12.5 mm winding length.

NARM 1 Coil: 5000 turns of 46 AWG single enameled copper wire on an elliptical coil former of 10.4 mm winding length.

REED SWITCH OPERATION METHODS

Operation Using a Coil

Figures 2, 3 and 4 illustrate the various methods of operating the switch using a coil.

With the method given in Fig. 4, the dry-reed switch and/or permanent magnet can be placed either within or outside the coil.

Fig.2: A dry-reed switch mounted within a coil

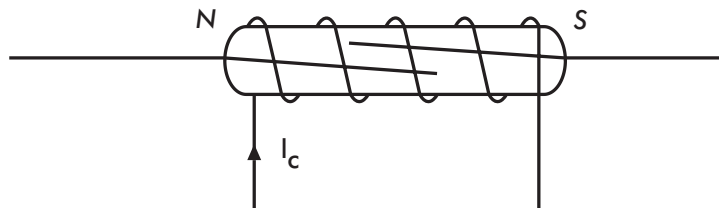

Fig. 3: A dry-reed switch mounted outside a coil

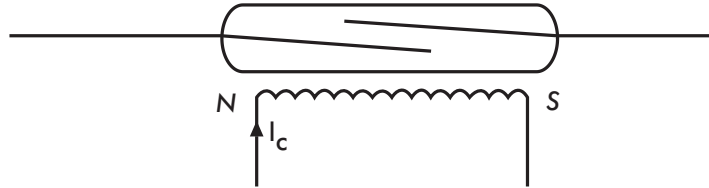
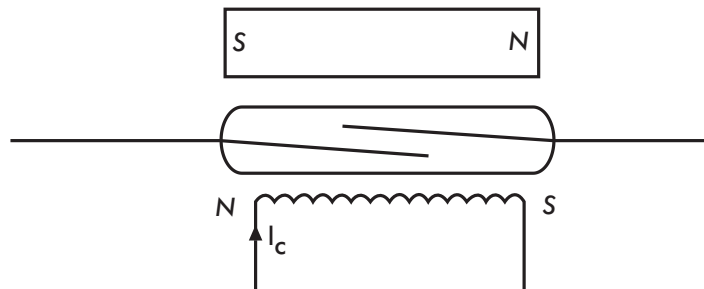

Fig.4: A dry-reed switch biased by a permanent magnet and operated by a coil



SWITCH TECHNICAL & APPLICATIONS INFORMATION

REED SWITCH OPERATION METHODS

Operation Using a Permanent Magnet

Permanent magnets are also often used to operate dry-reed switches. Figures 5, 6, 7 and 8 illustrate the various methods available.

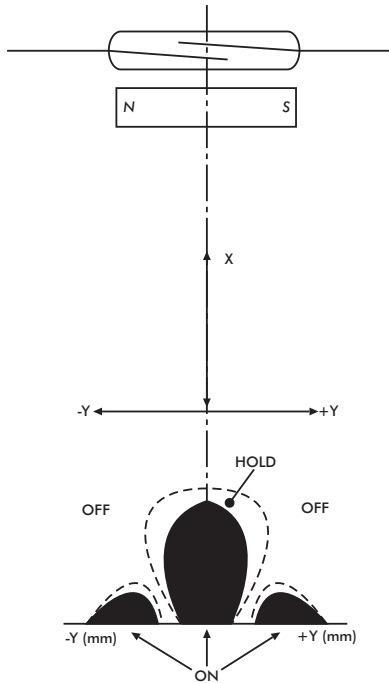

Fig. 5: Movement, with the magnetic field parallel to the dry-reed switch

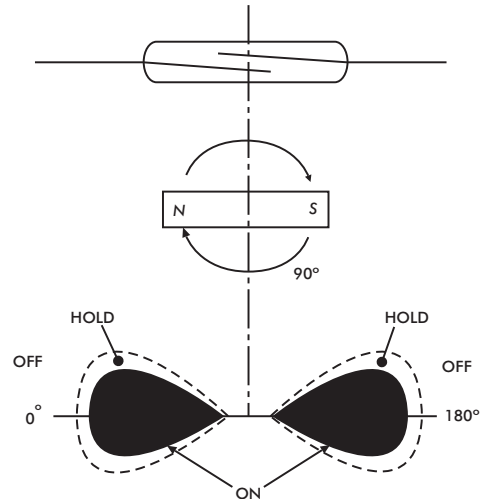

Fig. 7: Rotational movement with a bar shaped permanent magnet

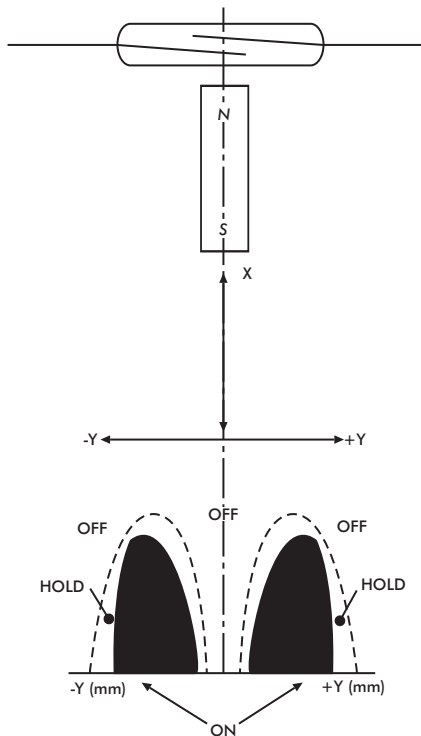

Fig. 6: Movement, with the magnetic field perpendicular to the dry-reed switch

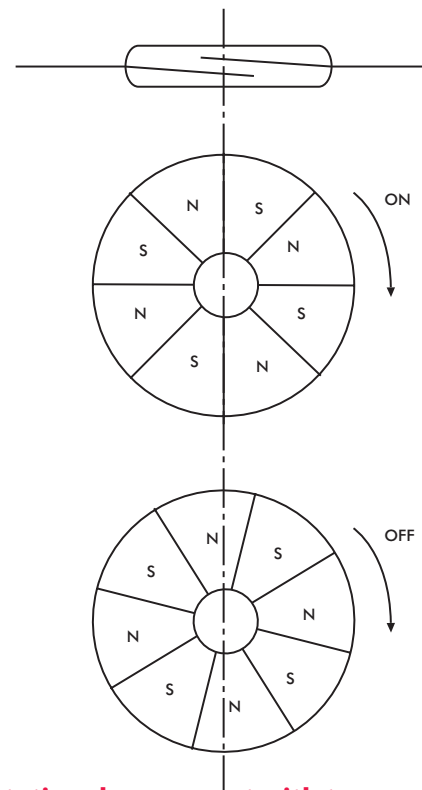

Fig. 8: Rotational movement with two or more pole ring magnets

REED SWITCH OPERATION METHODS

Shielding

Ferromagnetic materials which shunt the magnetic fields may be used to shield a dry-reed switch (see Fig. 9).

Fig. 9: Shielding a magnetically operated switch

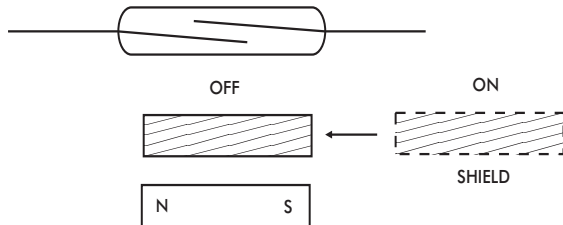

Magnetic Application

There are many applications for dry-reed switches used in combination with a permanent magnet. Figure 10 shows the relationship between the Gauss values of a permanent magnet and the AT values of Coto dry-reed switches in the Philips Standard Coil. It enables the customer to determine which reed switch AT range can be used in combination with a specific permanent magnet.

Fig. 10: Relationship between the field strength of a permanent magnet and the ampere-turn values of Coto reed switches in the Philips Standard Coil

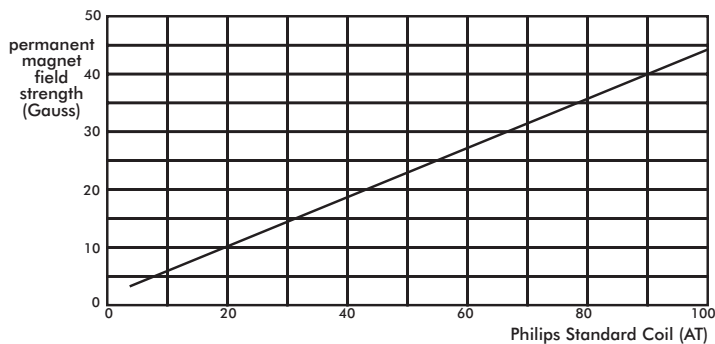

SWITCH TECHNICAL & APPLICATIONS INFORMATION

SWITCHING CONSIDERATIONS

Application Information

Should your application require further information, please consult your nearest Coto Technology sales office.

Contact Protection

Unless stated otherwise, the published life-expectancy data is based on resistive loads. For inductive, capacitive or lamp loads, inrush current or reverse voltage can affect the life of a reed switch. For a maximum life-time, contact protection is advised.

Fig. 11: DC voltage contact protection

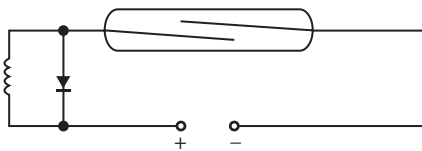
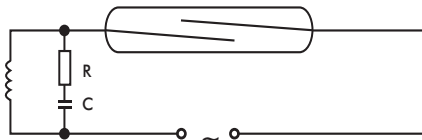

Fig. 12: AC voltage contact protection



Inductive Loads

To reduce the high reverse voltage produced when a reed switch opens, the following contact protection can be applied:

DC voltage: a diode parallel to the load or the reed switch (see Fig. 11).

AC voltage: An RC-network parallel to the load or the reed switch (see Fig. 12).

$$C = \frac{I^2}{10}$$

and

$$R = \frac{U}{10 \left(1 + \frac{50}{U} \right)}$$

where: C in μF ; I in A; R in Ω ; U in V.

Capacitive Loads

To reduce the high inrush current when a reed switch closes, a resistor must be connected in series with the capacitance or the reed switch.

When wiring a load and reed switch over a long distance, electrostatic capacitance, arising from the cable, can damage the reed switch. To protect against this capacitance a series surge protector (L) or a resistor should be connected in series.

Lamp Loads

To reduce the high inrush current when a cold incandescent lamp has to be switched by a reed switch (closing only), a resistor must be connected in series with the lamp or parallel to the reed switch.