



UM11076

TEA1936xDB1530 multistandard 27 W HV mobile charging demo board

Rev. 1 — 7 March 2018

User manual

Document information

Information	Content
Keywords	TEA1936xDB1530, Universal Serial Bus (USB), power delivery, USB-PD, quick charge USB-PD, QC2.0, QC3.0, QC4.0, USB type-C
Abstract	<p>This user manual describes the performance, technical data, and the connections of the TEA1936xDB1530 demo board.</p> <p>The TEA1936xDB1530 demo board operates at mains voltages from 90 V (AC) up to 264 V (AC). It can produce the standard 5 V, 9 V, and 12 V DC output voltages. However, it can also produce any voltage from 3.3 V up to 11 V DC at 27 W maximum power.</p>



TEA1936xDB1530 multistandard 27 W HV mobile charging demo board**Revision history**

Rev	Date	Description
v.1	20180307	first issue

1 Introduction

Warning



The non-insulated high voltages that are present when operating this product, constitute a risk of electric shock, personal injury, death and/or ignition of fire. This product is intended for evaluation purposes only. It shall be operated in a designated test area by personnel qualified according to local requirements and labor laws to work with non-insulated mains voltages and high-voltage circuits. This product shall never be operated unattended.

This user manual describes the operation of the TEA1936xDB1530 demo board featuring the TEA19361 quasi-resonant controller, the TEA1993 synchronous rectifier controller, and the TEA19051B USB-PD Type-C and QC2.0/3.0 controller.

The TEA1936xDB1530 demo board is designed to deliver a maximum output power of 27 W. The output voltage can be selected at 5 V, 9 V, or 12 V. At 5 V and 9 V output voltage, the maximum output current is 3 A. At 12 V, the maximum output current is 2.3 A. Also, any voltage between 3.3 V (DC) and 11 V (DC) can be requested at a maximum current of 3 A and 27 W maximum power.

The TEA1936xDB1530 provides an effective solution with a low output current ripple and high efficiency for USB-PD and quick charge applications.

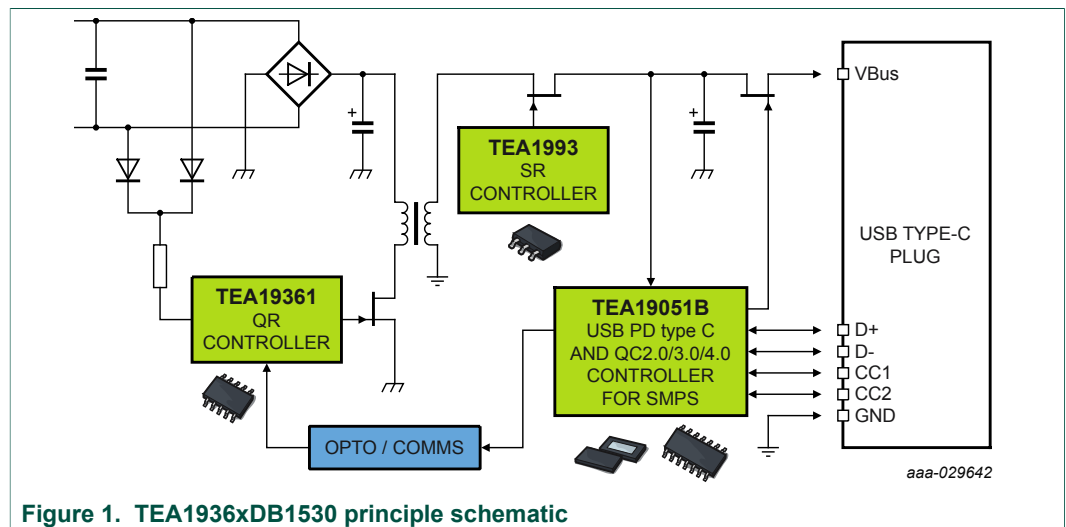

Figure 1. TEA1936xDB1530 principle schematic

1.1 Key features

- Multi-protocol support for USB-PD 2.0 & 3.0, Quick Charge 2.0, 3.0, 4.0
- Functionality user configurable end of line through the USB type-C interface
- Best-in-class energy efficiency meeting all DOE & EU CoC requirements
- No-load power < 30 mW when the USB (type C) cable is left unconnected
- Low audible noise; low output voltage ripple
- Small size due to high near-full digital integration level; $\approx 11 \text{ W/inch}^3$ power density
- Best-in-class thermal management
- Safe solution with extensive set of hardware-integrated protection features
- Complete one-stop-shop solution from NXP Semiconductors minimizing development time and research and development cost

1.2 Applications

Mobile chargers with Type-C cable for:

- Mobile phones
- Smart phones
- Tablets
- Netbooks

The new smart charger platform of NXP Semiconductors helps designers of travel adapters to maximize power output for the smallest form-factor with the lowest bill of materials.

The result is a cost-effective design that meets the requirements published by Energy Star, the Department of Energy (DoE) in the United States, the Ecodesign Directive of the European Union, the European Code of Conduct, and other guidelines.

Supporting hardware (UTC) and software (GUI) for USB-PD available for jump-starting application.

2 Safety warning

The TEA1936xDB1530 demo board is connected to the mains voltage. Avoid touching the board while it is connected to the mains voltage and when it is in operation. An isolated housing is obligatory when used in uncontrolled, non-laboratory environments. Galvanic isolation from the mains phase using a fixed or variable transformer is always recommended.

Figure 2 shows the symbols on how to recognize these devices.

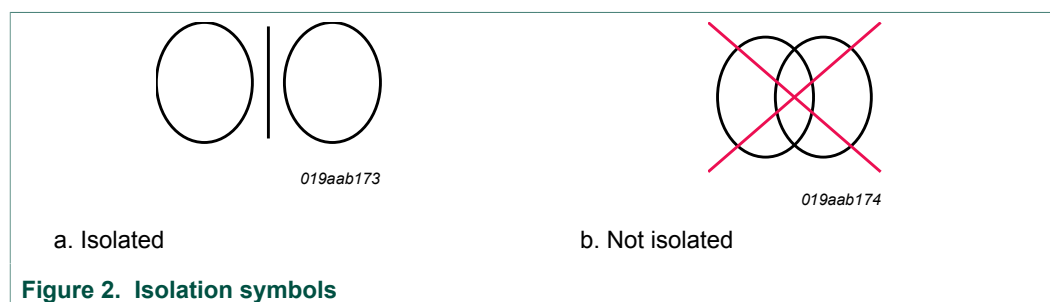

3 Specifications

Table 1. TEA1936xDB1530 specifications

Symbol	Parameter	Value
V_{mains}	AC mains voltage	90 V (AC) up to 264 V (AC)
$P_{\text{out(max)}}$	maximum output power	27 W
f_{mains}	mains frequency	47 Hz to 63 Hz
P_{idle}	no-load input power	< 30 mW
η	efficiency	> 90 %; at $P_{\text{out(max)}}$
V_{out}	output voltage	5 V (DC), 9 V (DC), 12 V (DC); any voltage between 3.3 V and 11 V.
$I_{\text{out(max)}}$	maximum output current	3 A
$V_{\text{ripple(burst)}}$	output voltage ripple in burst mode	< 80 mV (p-p); at board end
$V_{\text{ripple(full)}}$	output voltage ripple at continuous switching	< 50 mV (p-p); at board end
EMI	conducted EMI	typically > 6 dB margin
CMN	common-mode noise	< 2 V (p-p)

4 Board photographs

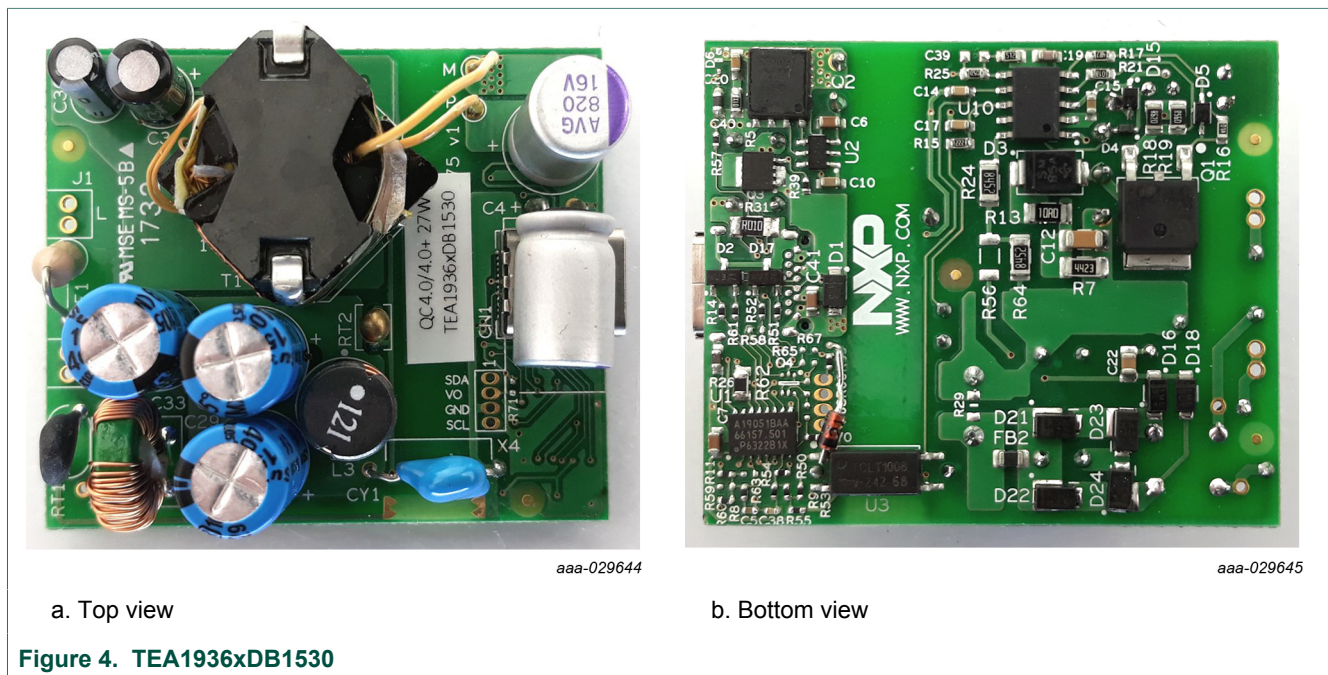
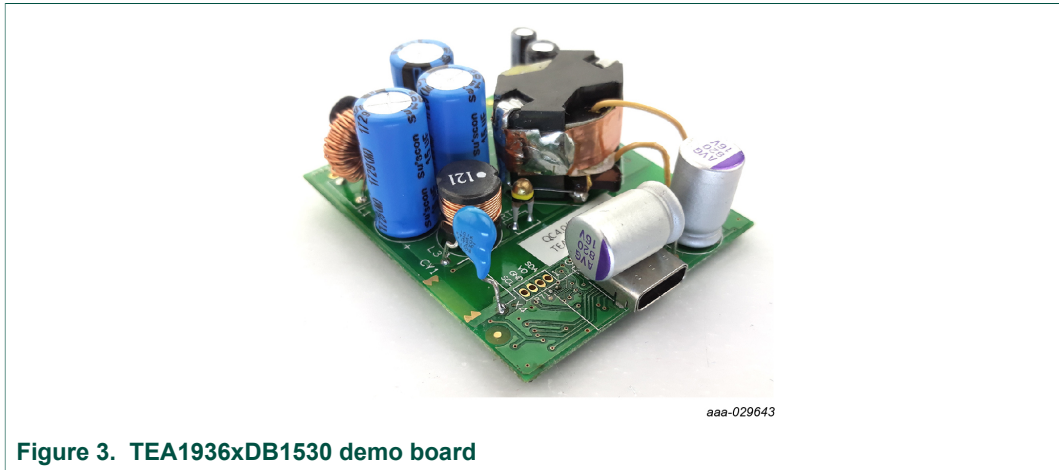

5 TEA1936xDB1530 demo board connections

The TEA1936xDB1530 demo board is a universal mains supplied application. The output is a USB type-C receptacle. Setting the output voltage is done through the USB type-C interface. Additionally, the TEO II graphical user interface software provides the option to program other output voltages and limit currents into the TEA19051B PD controller IC. [Section 7](#) lists the default settings.

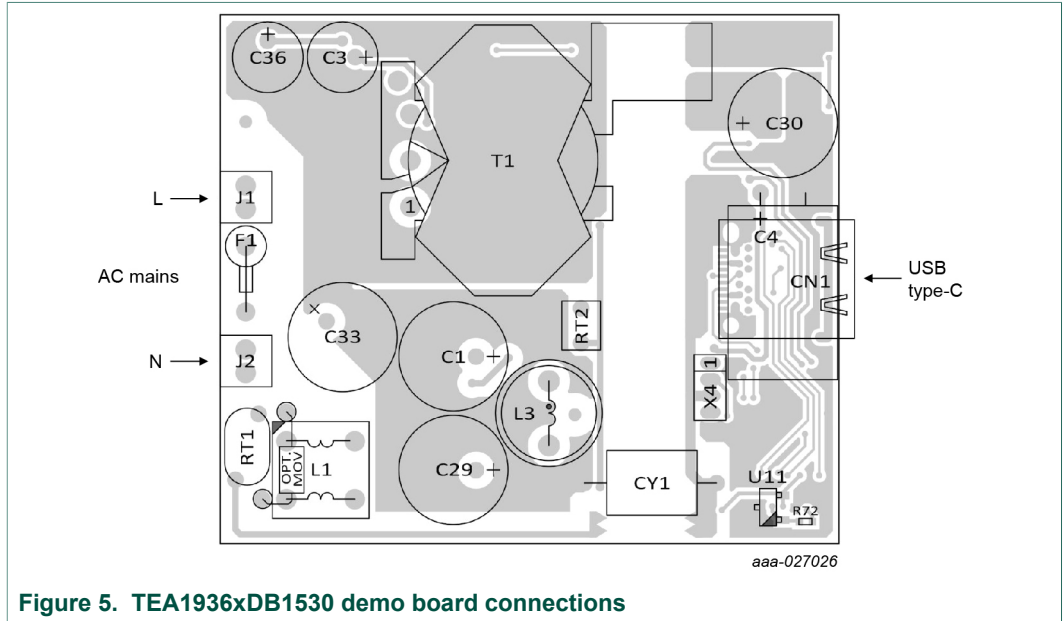

6 TEA1936xDB1530 demo board performance

6.1 Efficiency

Table 2. Efficiency at 5 V output (PCB end)

Load	Efficiency at 115 V (AC)	Efficiency at 230 V (AC)
10 % (0.3 A)	88.2 %	85.9 %
25 % (0.75 A)	89.5 %	87.4 %
50 % (1.5 A)	90.1 %	88.3 %
75 % (2.25 A)	90.3 %	88.7 %
100 % (3 A)	90 %	90 %
4-point average	90.0 %	88.5 %

Table 3. Efficiency at 9 V output (PCB end)

Load	Efficiency at 115 V (AC)	Efficiency at 230 V (AC)
10 % (0.3 A)	87.9 %	86.2 %
25 % (0.75 A)	90.4 %	89.1 %
50 % (1.5 A)	91.5 %	90.4 %
75 % (2.25 A)	91.8 %	91.1 %
100 % (3.0 A)	91.2 %	91.2 %
4-point average	91.2 %	90.5 %

Table 4. Efficiency at 12 V output (PCB end)

Load	Efficiency at 115 V (AC)	Efficiency at 230 V (AC)
10 % (0.23 A)	86.9 %	85.3 %
25 % (0.575 A)	90.1 %	89.0 %
50 % (1.15 A)	90.5 %	88.4 %
75 % (1.725 A)	91.9 %	92.0 %
100 % (2.3 A)	91.4 %	91.3 %
4-point average	91.0 %	90.1 %

6.2 No-load power consumption

Table 5. No-load power consumption (USB type-C cable disconnected)

Input voltage	No-load power
90 V (AC)/60 Hz	24 mW
115 V (AC)/60 Hz	23 mW
230 V (AC)/50 Hz	23 mW
264 V (AC)/50 Hz	32 mW

6.3 Output voltage ripple

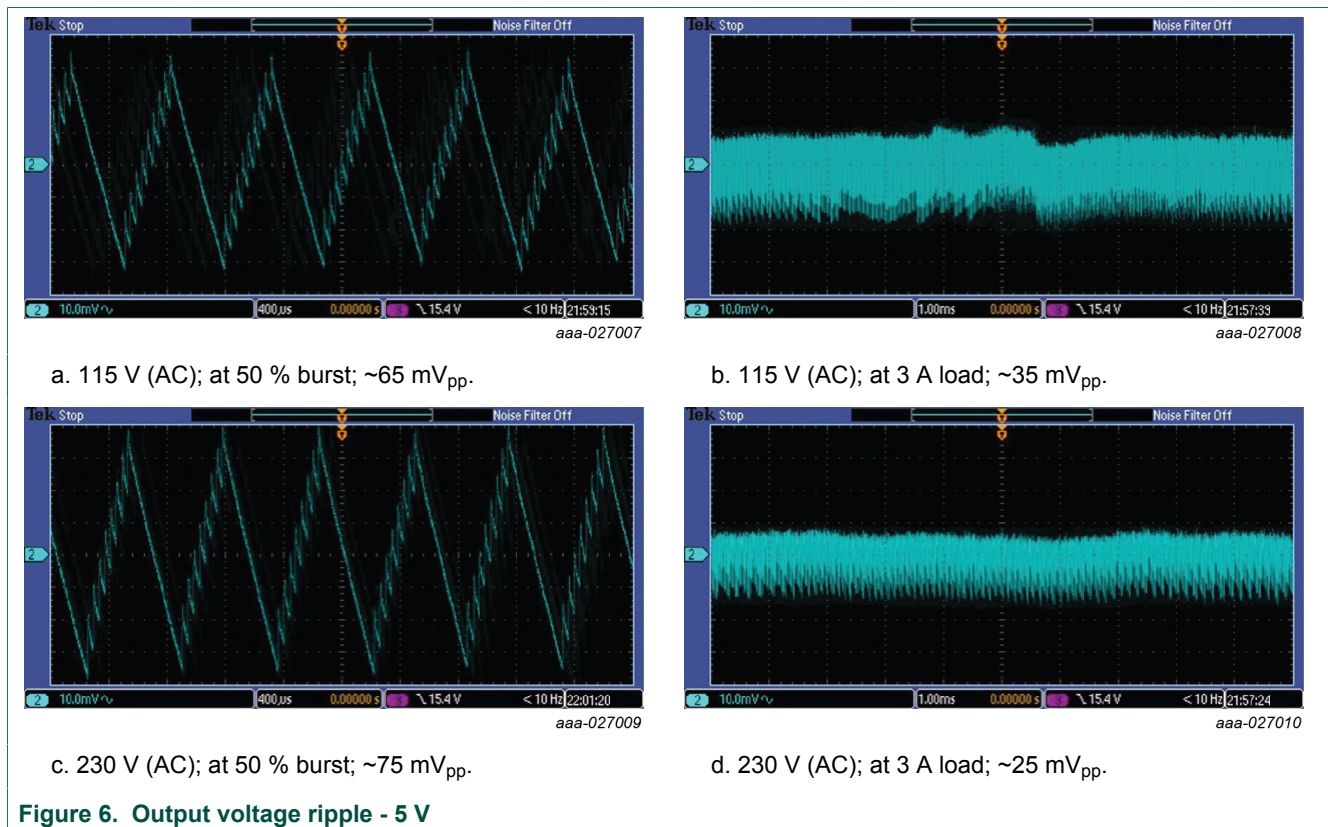

6.4 Load step behavior

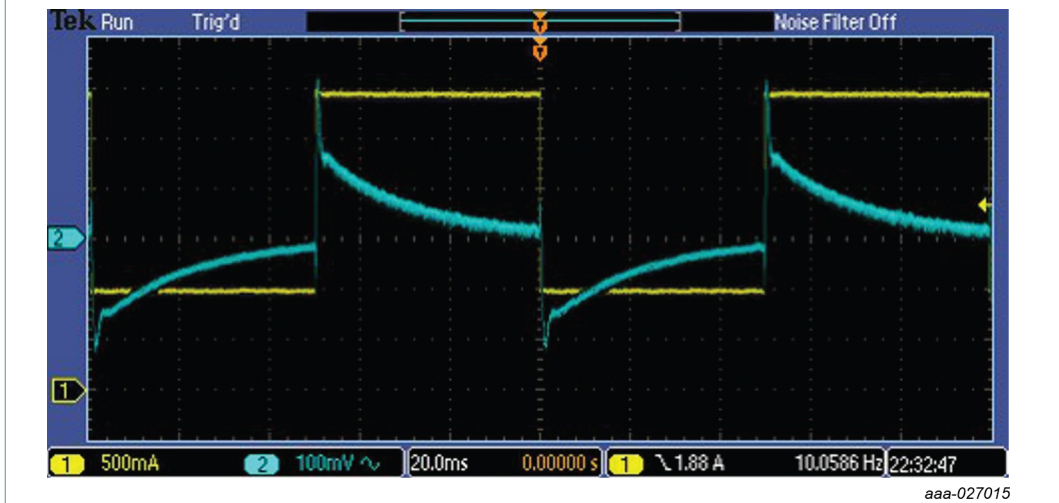

Voltage overshoot \approx 350 mV; voltage undershoot \approx 350 mV.

Figure 7. Load step behavior at 5 V output, load alternating between 1 A and 3 A

6.5 ElectroMagnetic Interference (EMI)

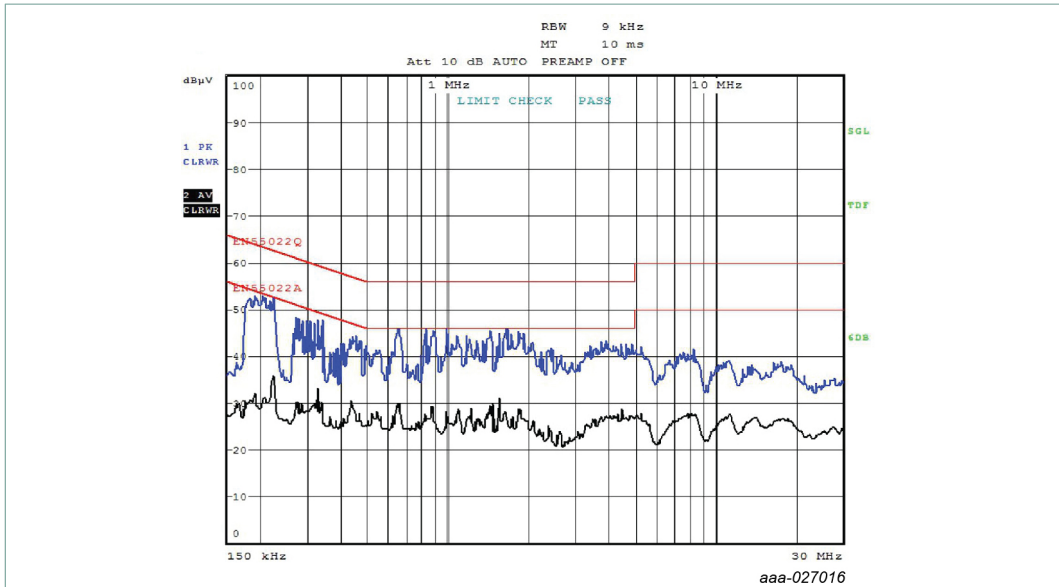

Protective earth not connected to secondary ground.

Figure 8. Conducted EMI at full load 115 V (AC)/60 Hz; pass with > 10 dB margin

TEA1936xDB1530 multistandard 27 W HV mobile charging demo board

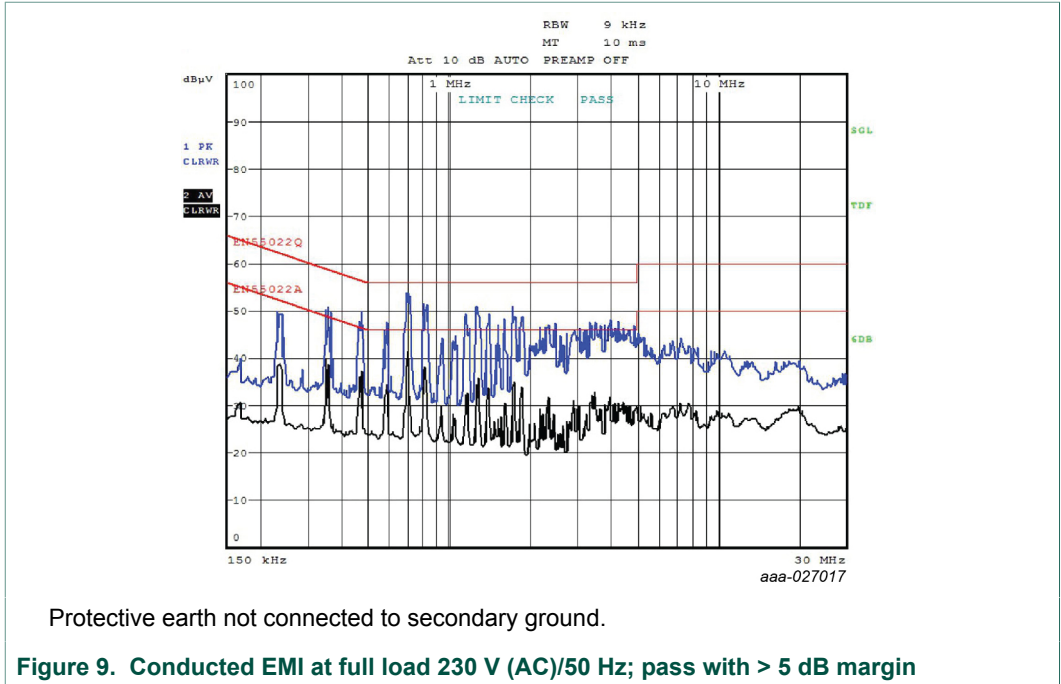

6.6 Common-mode noise cf. IEC62684

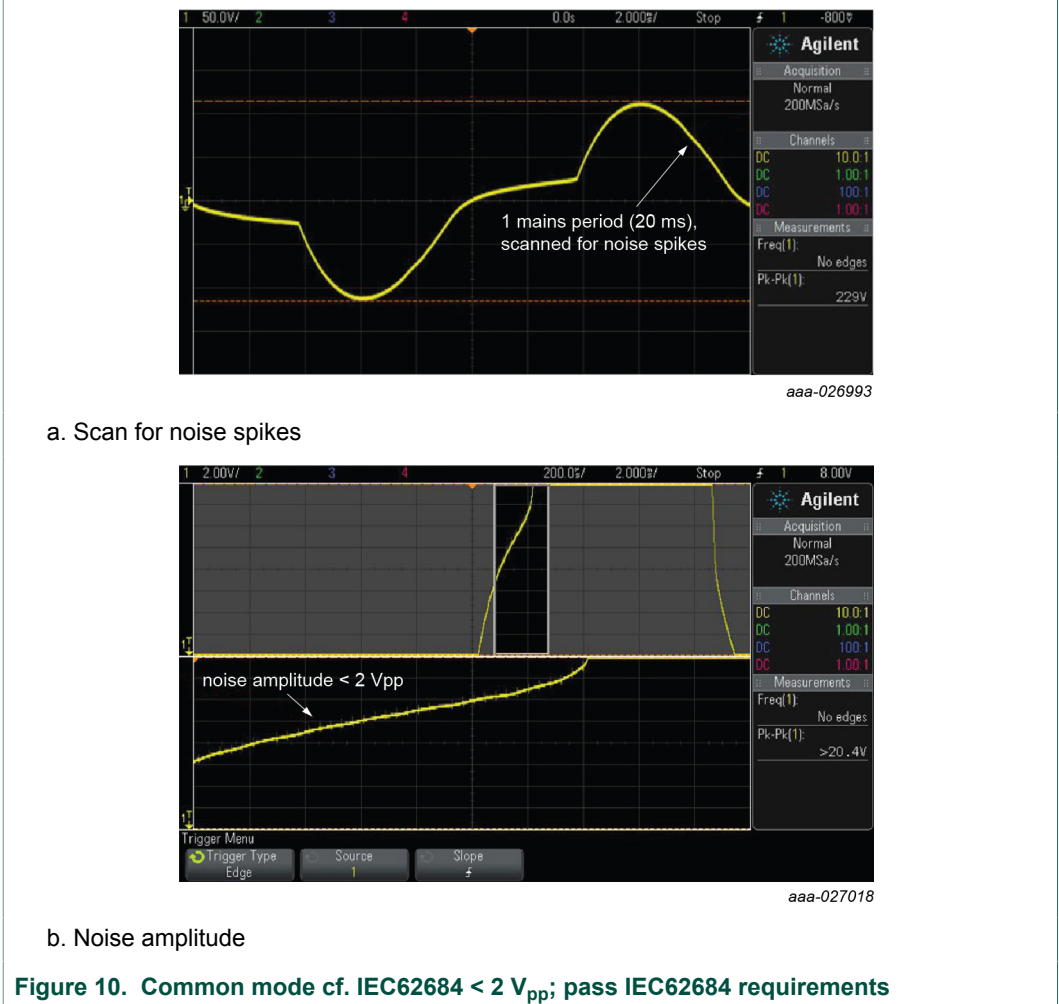

6.7 Thermal

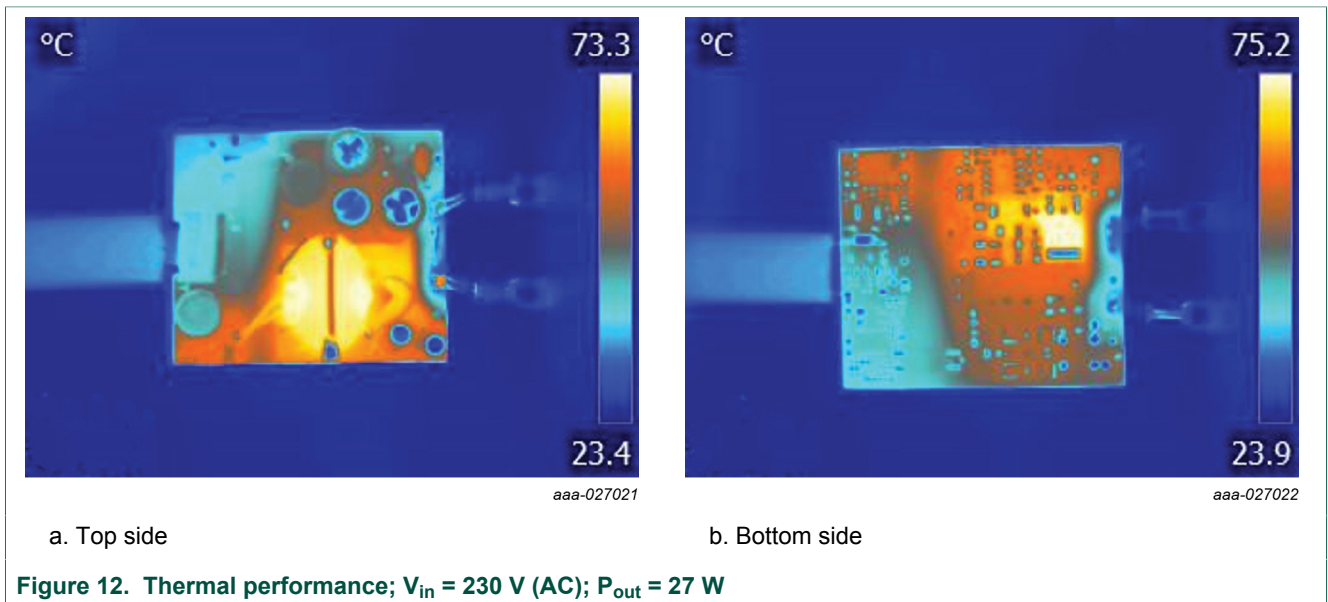
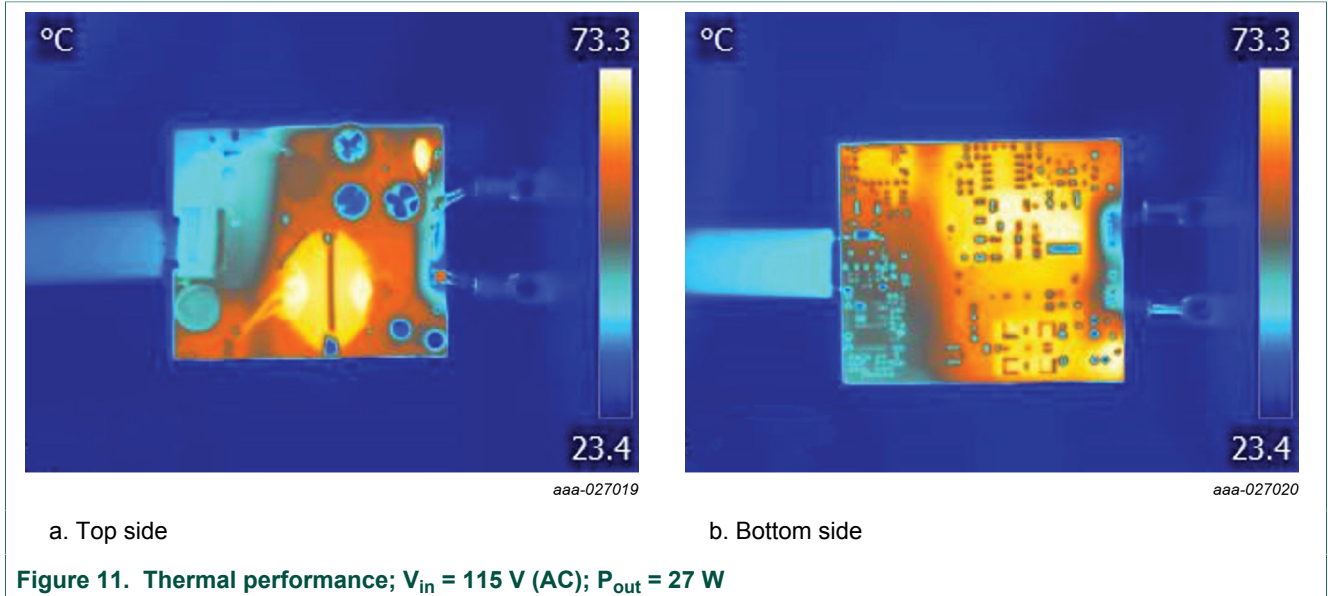

Note: Typical temperature distribution at $T_{amb} = 25 \text{ °C}$; PCB in free air, natural convection, and radiation only.

7 PDO settings

The output voltages and currents for the efficiency measurement were set as shown in [Table 6](#).

Table 6. PDO settings

Default values for demo board TEA1936xDB1530

PDO (#)	V _{out} (V)	I _{out} (A)
1	5	3
2	9	3
3	12	2.3
4	3.3 to 5.9	3
5	3.3 to 11	3

PDO settings can be changed by reprogramming the MTP settings of the TEA19051B via the USB type-C connector using the TEO II software. However, for the TEA1936xDB1530 demo board, the voltage levels must not exceed 12 V. Current limit levels must not exceed 3 A. Power limit levels must not exceed 27 W (see the TEA190x Evaluation Overdrive (TEO) user manual ([Ref. 1](#))).

Note: *The PDOs must have an ascending voltage and power in order to work correctly. So, $V(\text{PDO}, i + 1) > V(\text{PDO}, i)$ and also $P(\text{PDO}, i + 1) > P(\text{PDO}, i)$.*

8 Schematic

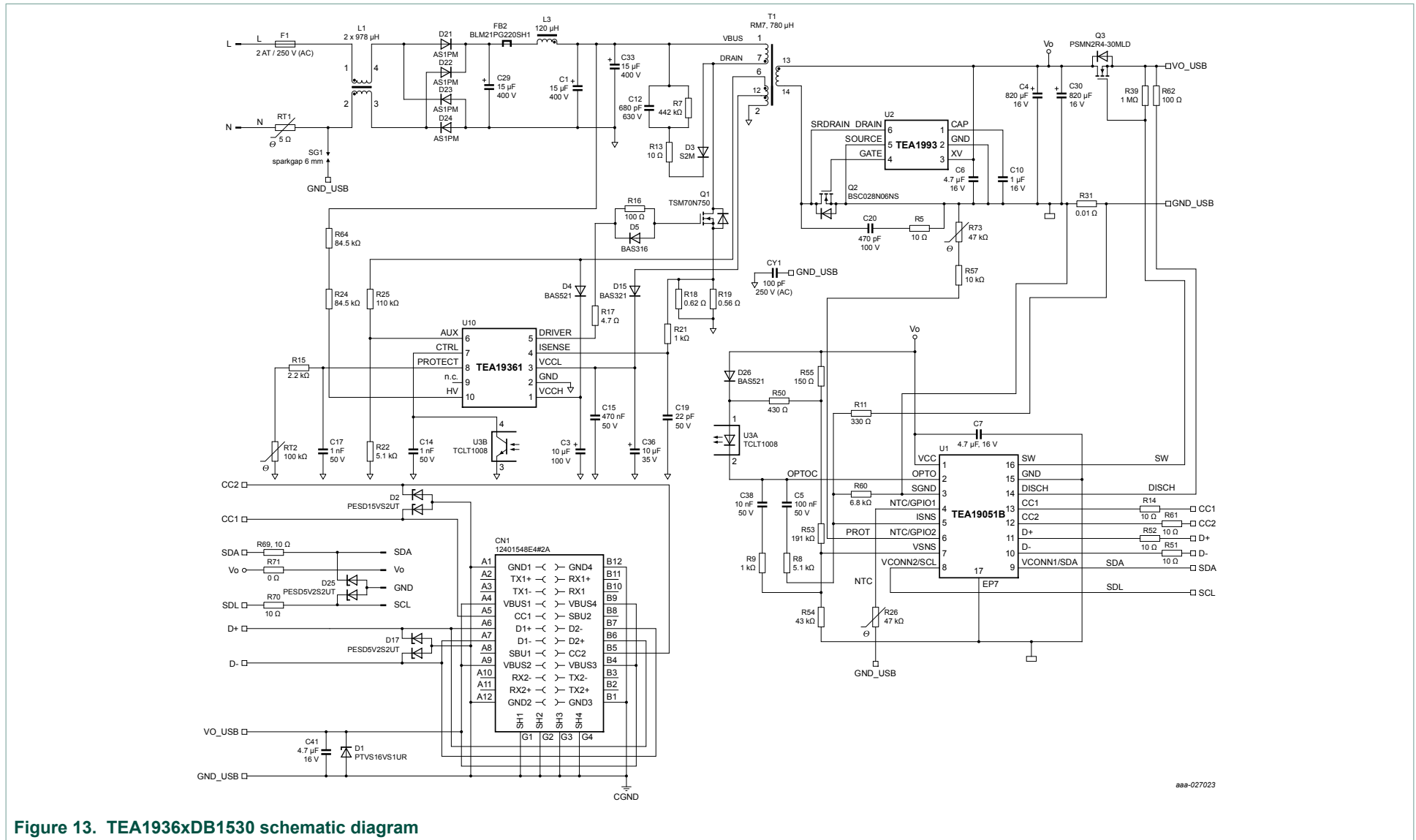

Figure 13. TEA1936xDB1530 schematic diagram

TEA1936xDB1530 multistandard 27 W HV mobile charging demo board

9 Bill Of Materials (BOM)

Table 7. TEA1936xDB1530 BOM

Reference	Description and values	Part number	Manufacturer
C1	capacitor; 15 μ F; 20 %; 400 V; ALU; THT	EKM156M2GF16RR	Samxon
C3	capacitor; 10 μ F; 20 %; 100 V; ALU; THT	100YXJ10M5X11	Rubycon
C4	capacitor; 820 μ F; 20 %; 16 V; ALU; THT	827AVG016MFBJ	Illinois Capacitors
C5	capacitor; 100 nF; 10 %; 50 V; X7R; 0402	C1005X7R1H104K050BB	TDK
C6; C7	capacitor; 4.7 μ F; 10 %; 16 V; X5R; 0603	C1608X5R1C475K080AC	TDK
C10	capacitor; 1 μ F; 10 %; 16 V; X7R; 0603	-	-
C12	capacitor; 680 pF; 10 %; 630 V; X7R; 1206	C1206C681KBRAC	KEMET
C14	capacitor; 1 nF; 10 %; 50 V; X7R; 0603	-	-
C15	capacitor; 470 nF; 10 %; 50 V; X7R; 0603	C1608X7R1H474K	TDK
C17	capacitor; 1 nF; 10 %; 50 V; X7R; 0603	-	-
C19	capacitor; 22 pF; 5 %; 50 V; C0G; 0603	-	-
C20	capacitor; 470 pF; 10 %; 100 V; X7R; 0603	-	-
C29; C33	capacitor; 15 μ F; 20 %; 400 V; ALU; THT	EKM156M2GF16RR	Samxon
C30	capacitor; 820 μ F; 20 %; 16 V; ALU; THT	827AVG016MFBJ	Illinois Capacitors
C36	capacitor; 10 μ F; 20 %; 35 V; ALU; THT	UVR1V100MDD6TP	Nichicon
C38	capacitor; 10 nF; 10 %; 50 V; X7R; 0402	-	-
C41	capacitor; 4.7 μ F; 10 %; 16 V; X5R; 0603	C1608X5R1C475K080AC	TDK
CN1	connector; USB 3.1 type-C receptacle R/A	12401548E4#2A	Amphenol
CY1	capacitor; 100 pF; 10 %; 250 V (AC); B; THT; X1/Y2	DE2B3KY101KA2BM01F	Murata
D1	diode; TVS; unidirectional; 16 V; 400 W	PTVS16VS1UR	NeXperia USA Inc
D2	diode; ESD protection; 30 kV; 3 A	PESD15VS2UT	NeXperia USA Inc
D3	diode; 1 kV; 2 A	S2M	Fairchild
D4; D26	diode; 300 V; 250 mA	BAS521	NeXperia USA Inc
D5	diode; 100 V; 250 mA	BAS316	NXP Semiconductors
D15	diode; 200 V; 250 mA	BAS321	NeXperia USA Inc
D17; D25	diode; ESD protection; 30 kV; 3 A	PESD5V2S2UT	NeXperia USA Inc
D21; D22; D23; D24	diode; 1 kV; 1.5 A	AS1PM-M3/84A	Vishay
F1	fuse; slow blow; 250 V; 2 A	MCPMP2A250V	Multicomp
FB2	fbead; 0.009 O; 6 A; 0805	BLM21PG220SH1D	Murata
L1	Inductor CM; EE7.0; Cu = 0.27 mm; 18T:18T	-	NXP Semiconductors
L3	Inductor; 120 μ H	TEA1936xDB1530(L3)/7447721	NXP Semiconductors/ Würth Elektronik
Q1	MOSFET-N; 700 V; 0.75 O; 6 A	TSM70N750CP	Taiwan Semiconductor
Q2	MOSFET-N; 60 V; 100 A; TDFN	BSC028N06NS	Infineon

TEA1936xDB1530 multistandard 27 W HV mobile charging demo board

Reference	Description and values	Part number	Manufacturer
Q3	MOSFET-N; 30 V; 2.4 mΩ; 70 A	PSMN2R4-30MLD	NXP Semiconductors
R5	resistor; 10 Ω; 1 %; 63 mW; 0603	-	-
R7	resistor; 442 kΩ; 1 %; 660 mW; 1206	ERJP08F4423V	Panasonic
R8	resistor; 5.1 kΩ; 1 %; 63 mW; 0402	-	-
R9	resistor; 1 kΩ; 1 %; 63 mW; 0402	-	-
R11	resistor; 330 Ω; 1 %; 63 mW; 0402	-	-
R13	resistor; 10 Ω; 1 %; 250 mW; 1206	-	-
R14; R51; R52; R61; R69; R70	resistor; 10 Ω; 1 %; 100 mW; 0402;	ERJ2RKF10R0X	Panasonic
R15	resistor; 2.2 kΩ; 1 %; 63 mW; 0603	-	-
R16	resistor; 100 Ω; 1 %; 100 mW; 0603	-	-
R17	resistor; 4.7 Ω; 1 %; 100 mW; 0603	-	-
R18	resistor; 0.62 Ω; 1 %; 250 mW; 0805	ERJS6QFR47V	Panasonic
R19	resistor; 0.56 Ω; 1 %; 250 mW; 0805	ERJS6QFR56V	Panasonic
R21	resistor; 1 kΩ; 1 %; 63 mW; 0603	-	-
R22	resistor; 5.1 kΩ; 1 %; 63 mW; 0603	-	-
R24	resistor; 84.5 kΩ; 1 %; 660 mW; 500 V; 1206	ERJP08F8452V	Panasonic
R25	resistor; 110 kΩ; 1 %; 63 mW; 0603	-	-
R26	resistor; NTC; 47 kΩ; 5 %; 180 mW; 3980 K	B57321V2473J060	EPCOS
R31	resistor; 0.006 Ω; 1 %; 1 W; 1206	TLR2B10DR006FTDG	TE Connectivity
R39	resistor; 1 MΩ; 1 %; 63 mW; 0402	CRCW04021M00FKED	Vishay
R50	resistor; 430 Ω; 1 %; 100 mW; 0402	ERJ2RKF4300X	Panasonic
R53	resistor; 191 kΩ; 1 %; 63 mW; 0402	-	-
R54	resistor; 43 kΩ; 1 %; 63 mW; 0402	-	-
R55	resistor; 150 Ω; 1 %; 100 mW; 0402	ERJ2RKF1500X	Panasonic
R60	resistor; 6.8 kΩ; 1 %; 63 mW; 0402	-	-
R62	resistor; 100 Ω; 1 %; 500 mW; 0805	ERJP6WF1000V	Panasonic
R64	resistor; 84.5 kΩ; 1 %; 660 mW; 500 V; 1206	ERJP08F8452V	Panasonic
R71	resistor; jumper; 0 Ω; 100 mW; 0402	ERJ2GE0R00X	Panasonic
R73	resistor; NTC; 47 kΩ; 5 %; 180 mW; 2980 K	B57321V2473J060	EPCOS
RT1	ICL 5 Ω; 25 %; 1 A; 6 mm	SL05 5R001-A	Ametherm
RT2	resistor; NTC; 100 kΩ; 5 %; 100 mW; 4190 K	NTCLE100E3104JB0	Vishay
T1	transformer; RM7; TR1077	RM7, TR1077	NXP Semiconductors
U1	TEA19051B; HVSON16	TEA19051B (HVSON16)	NXP Semiconductors
U2	synchronous rectifier controller; TEA1993	TEA1993	NXP Semiconductors
U10	SMTP controller; TEA19361	TEA19361	NXP Semiconductors
U3	optocoupler; NPN; 70 V; 50 mA	TCLT1008	Vishay

10 Layout

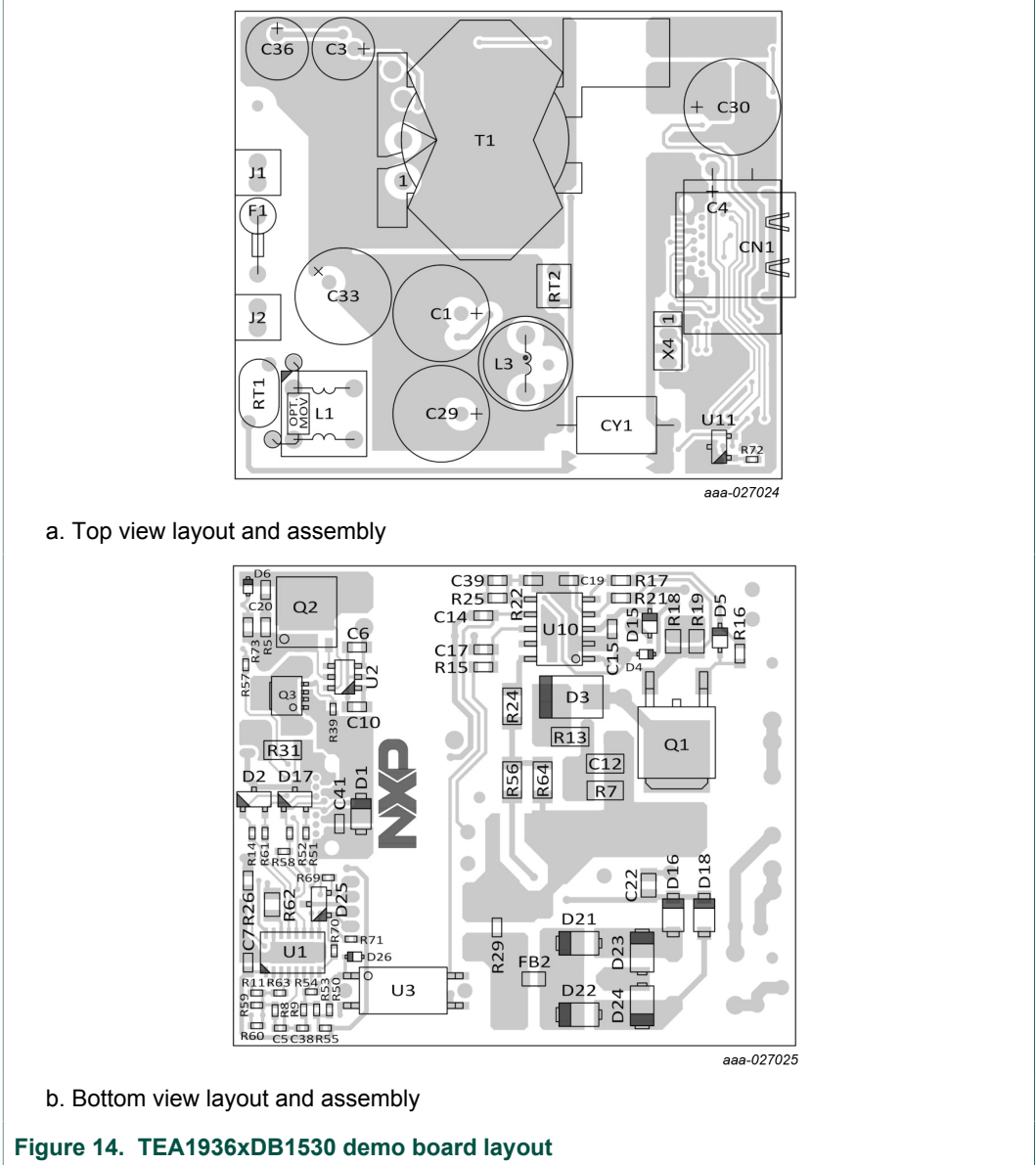

11 Abbreviations

Table 8. Abbreviations

Acronym	Description
CMN	Common-Mode Noise
EMI	ElectroMagnetic Interference
GUI	Graphical User Interface
MTP	Multiple Times Programmable
PCB	Printed-Circuit Board
PD	Power Delivery
PDO	Power Data Object
QC	Quick Charge
TEO	TEA190x Evaluation Overdrive
USB	Universal Serial Bus
UTC	Universal Type-C Controller

12 References

- 1 **UM11014 user manual** — TEA190x Evaluation Overdrive (TEO); 2017, NXP Semiconductors

13 Legal information

13.1 Definitions

Draft — The document is a draft version only. The content is still under internal review and subject to formal approval, which may result in modifications or additions. NXP Semiconductors does not give any representations or warranties as to the accuracy or completeness of information included herein and shall have no liability for the consequences of use of such information.

13.2 Disclaimers

Limited warranty and liability — Information in this document is believed to be accurate and reliable. However, NXP Semiconductors does not give any representations or warranties, expressed or implied, as to the accuracy or completeness of such information and shall have no liability for the consequences of use of such information. NXP Semiconductors takes no responsibility for the content in this document if provided by an information source outside of NXP Semiconductors. In no event shall NXP Semiconductors be liable for any indirect, incidental, punitive, special or consequential damages (including - without limitation - lost profits, lost savings, business interruption, costs related to the removal or replacement of any products or rework charges) whether or not such damages are based on tort (including negligence), warranty, breach of contract or any other legal theory. Notwithstanding any damages that customer might incur for any reason whatsoever, NXP Semiconductors' aggregate and cumulative liability towards customer for the products described herein shall be limited in accordance with the Terms and conditions of commercial sale of NXP Semiconductors.

Right to make changes — NXP Semiconductors reserves the right to make changes to information published in this document, including without limitation specifications and product descriptions, at any time and without notice. This document supersedes and replaces all information supplied prior to the publication hereof.

Suitability for use — NXP Semiconductors products are not designed, authorized or warranted to be suitable for use in life support, life-critical or safety-critical systems or equipment, nor in applications where failure or malfunction of an NXP Semiconductors product can reasonably be expected to result in personal injury, death or severe property or environmental damage. NXP Semiconductors and its suppliers accept no liability for inclusion and/or use of NXP Semiconductors products in such equipment or applications and therefore such inclusion and/or use is at the customer's own risk.

Applications — Applications that are described herein for any of these products are for illustrative purposes only. NXP Semiconductors makes no representation or warranty that such applications will be suitable for the specified use without further testing or modification. Customers are responsible for the design and operation of their applications and products using NXP Semiconductors products, and NXP Semiconductors accepts no liability for any assistance with applications or customer product

design. It is customer's sole responsibility to determine whether the NXP Semiconductors product is suitable and fit for the customer's applications and products planned, as well as for the planned application and use of customer's third party customer(s). Customers should provide appropriate design and operating safeguards to minimize the risks associated with their applications and products. NXP Semiconductors does not accept any liability related to any default, damage, costs or problem which is based on any weakness or default in the customer's applications or products, or the application or use by customer's third party customer(s). Customer is responsible for doing all necessary testing for the customer's applications and products using NXP Semiconductors products in order to avoid a default of the applications and the products or of the application or use by customer's third party customer(s). NXP does not accept any liability in this respect.

Export control — This document as well as the item(s) described herein may be subject to export control regulations. Export might require a prior authorization from competent authorities.

Evaluation products — This product is provided on an "as is" and "with all faults" basis for evaluation purposes only. NXP Semiconductors, its affiliates and their suppliers expressly disclaim all warranties, whether express, implied or statutory, including but not limited to the implied warranties of non-infringement, merchantability and fitness for a particular purpose. The entire risk as to the quality, or arising out of the use or performance, of this product remains with customer. In no event shall NXP Semiconductors, its affiliates or their suppliers be liable to customer for any special, indirect, consequential, punitive or incidental damages (including without limitation damages for loss of business, business interruption, loss of use, loss of data or information, and the like) arising out of the use of or inability to use the product, whether or not based on tort (including negligence), strict liability, breach of contract, breach of warranty or any other theory, even if advised of the possibility of such damages. Notwithstanding any damages that customer might incur for any reason whatsoever (including without limitation, all damages referenced above and all direct or general damages), the entire liability of NXP Semiconductors, its affiliates and their suppliers and customer's exclusive remedy for all of the foregoing shall be limited to actual damages incurred by customer based on reasonable reliance up to the greater of the amount actually paid by customer for the product or five dollars (US\$5.00). The foregoing limitations, exclusions and disclaimers shall apply to the maximum extent permitted by applicable law, even if any remedy fails of its essential purpose.

Translations — A non-English (translated) version of a document is for reference only. The English version shall prevail in case of any discrepancy between the translated and English versions.

13.3 Trademarks

Notice: All referenced brands, product names, service names and trademarks are the property of their respective owners.

GreenChip — is a trademark of NXP B.V.

Contents

1	Introduction	3
1.1	Key features	4
1.2	Applications	4
2	Safety warning	5
3	Specifications	5
4	Board photographs	6
5	TEA1936xDB1530 demo board connections	7
6	TEA1936xDB1530 demo board performance	8
6.1	Efficiency	8
6.2	No-load power consumption	9
6.3	Output voltage ripple	9
6.4	Load step behavior	10
6.5	ElectroMagnetic Interference (EMI)	10
6.6	Common-mode noise cf. IEC62684	12
6.7	Thermal	13
7	PDO settings	14
8	Schematic	15
9	Bill Of Materials (BOM)	16
10	Layout	18
11	Abbreviations	19
12	References	19
13	Legal information	20

Please be aware that important notices concerning this document and the product(s) described herein, have been included in section 'Legal information'.

© NXP B.V. 2018.

All rights reserved.

For more information, please visit: <http://www.nxp.com>

For sales office addresses, please send an email to: salesaddresses@nxp.com

Date of release: 7 March 2018
Document identifier: UM11076