

LQW15CNR27J1Z#

indicates a package specification code.



< List of part numbers with package codes >
 LQW15CNR27J1ZD , LQW15CNR27J1ZB

Shape

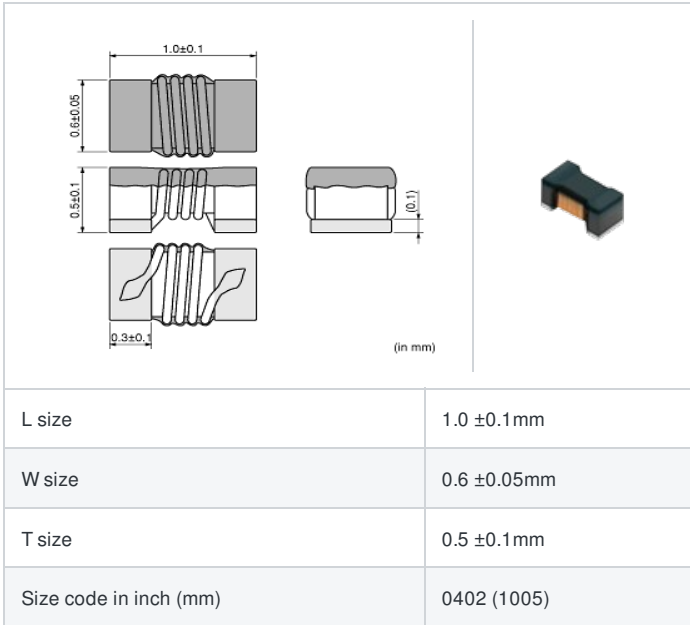

Notes

In operating temperature exceeding +85°C, derating of current is necessary for LQW15C series.
 Please apply the derating curve shown in chart according to the operating temperature.
 Please confirm "Notice (Rating)".

References

Packaging code	Specifications	Minimum quantity
D	φ180mm Paper taping	10000
B	Packing in bulk	500

Mass (Typ.)	
1 piece	0.001g

Specifications

Inductance	270nH ±5%
Inductance test frequency	100MHz
Rated current (Itemp) (Based on Temperature rise)	420mA
Max. of DC resistance	0.52Ω
Self resonance frequency (min.)	830MHz
Operating temperature range (Self-temperature rise is not included)	-40~125°C
Class of magnetic shield	No Shield
Series	LQW15CN_1Z

Attention

- 1.This datasheet is downloaded from the website of Murata Manufacturing Co., Ltd. Therefore, it's specifications are subject to change or our products in it may be discontinued without advance notice. Please check with our sales representatives or product engineers before ordering.
- 2.This datasheet has only typical specifications because there is no space for detailed specifications. Therefore, please review our product specifications or consult the approval sheet for product specifications before ordering.

Chart of characteristic data (The charts below may show another part number which shares its characteristics.)

▪ Inductance-Frequency characteristics (Typ.)

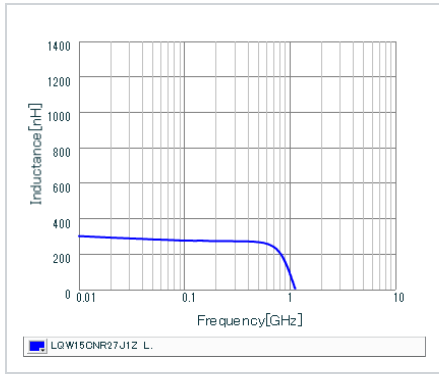

▪ Q-Frequency characteristics (Typ.)

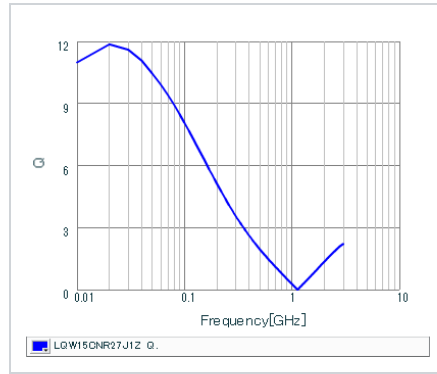

▪ Notice (Rating)

In operating temperature exceeding +85°C, derating of current is necessary for LQW15C series. Please apply the derating curve shown in chart according to the operating temperature.

Derating of Rated Current

Operating Temperature (°C)	Rated Derating (%)
0	100
85	100
125	50

⚠ Attention

- 1.This datasheet is downloaded from the website of Murata Manufacturing Co., Ltd. Therefore, it's specifications are subject to change or our products in it may be discontinued without advance notice. Please check with our sales representatives or product engineers before ordering.
- 2.This datasheet has only typical specifications because there is no space for detailed specifications. Therefore, please review our product specifications or consult the approval sheet for product specifications before ordering.