

NOTES: VALID UNLESS OTHERWISE SPECIFIED

1. GENERAL:
  - a. APPLICATION SPECIFICATION SEE: AS-34791-020
  - b. PRODUCT SPECIFICATION SEE: PS-34791-020
  - c. PACKAGING SPECIFICATION PER MOLEX DRAWING: SEE CHART
  - d. PARTS MUST BE IN COMPLIANCE TO MOLEX CHEMICAL SUBSTANCES FOR PRODUCTS AND PACKAGING SPECIFICATION: PS-40000-5015
  - e. DATA MUST BE SUBMITTED UNDER THE MOLEX PART NUMBER TO IMDS (COMPANY ID#13255)
  - f. FLAMMABILITY REQUIREMENT: PER ISO3795 OR GM3191
    1. BURN RATE 100 mm/MIN MAXIMUM
    2. MATERIAL MUST BE SELF EXTINGUISHING
  - g. VISUAL DEFECTS SHALL MEET COSMETIC STANDARD PS-45499-002 (Class B)
2. DESIGN - MATERIALS:
  - a. MATERIAL: UNFILLED PBT
3. DESIGN - GEOMETRY:
  - a. THIS IS A 100% CAD GENERATED PART. THE CAD MATHEMATICAL DATA IS THE MASTER FOR THIS PART. FOR DIMENSIONAL OR ANY INFORMATION NOT SHOWN ON THIS DRAWING, ANALYZE THE CAD MODEL.
  - b. GEOMETRIC DIMENSIONS AND TOLERANCES PER ASME Y14.5 - 2009
  - c. GENERAL TOLERANCES:
    - LINEAR: PER DIN 16901 CODE B FOR PRECISION ENGINEERING (SEE TABLE)
    - ANGULAR: +3°
  - d. EDGES AND UNDIMENSIONED DETAILS PER ISO13715
  - e. CORNERS SHOWN AS SHARP TO BE R 0.2 MAX
  - f. LETTERING SHALL BE 0.1 MAX RAISED IN 0.15 MAX RECESS PAD AND NOT PROTRUDE THE SURFACE. THIS INCLUDES RECYCLING CODE, PLANT ID, CAVITY ID, VENDOR ID, CIRCUIT ID, AND PART SERIES NUMBER.
  - g. DIMENSION APPLIES ONLY TO RECEPTACLES WITH LOCK BRIDGE OPTION.
4. DESIGN - FUNCTIONALITY:
  - a. HINGE DOES NOT AFFECT FUNCTION OF THE PART.

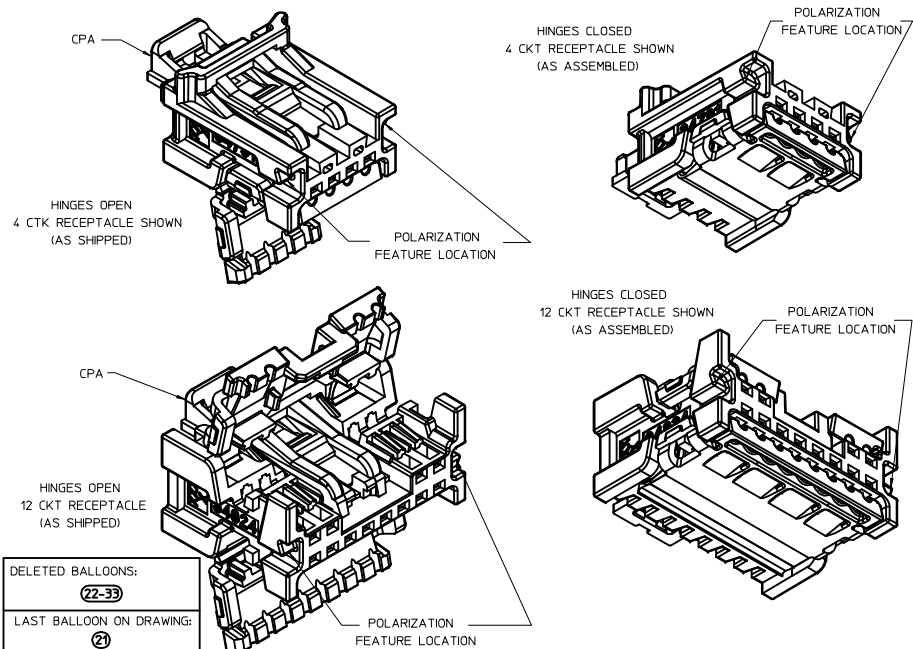

DELETED BALLOONS:  
~~(22-33)~~

LAST BALLOON ON DRAWING:  
(2)

UPDATED 4.8.12 P/N ELC NO: UA02016-0125 DRAWN BY: DRANKREHMT CHKD: APPR:RBAUMAN 2015/07/28	QUALITY SYMBOLS	GENERAL TOLERANCES (UNLESS SPECIFIED)	DIMENSION STYLE	SCALE	DESIGN UNITS	THIRD ANGLE PROJECTION
	▽=0	mm INCH	MM ONLY	5:1	METRIC	☐
	▽=0.10	4 PLACES ± --- ± ---	DRAWN BY DATE			TITLE
	▽=0.20	3 PLACES ± --- ± ---	CHECKED BY DATE	MYOUNG01 2013/01/31		MINI 50 SINGLE/DUAL ROW CPA-RECEPTACLE ASSEMBLY SALES DRAWING
▽=0	2 PLACES ± 0.10 ± ---	APPROVED BY DATE	RBAUMAN 2013/11/13		<b>molex</b>	SHEET NO.
	1 PLACE ± 0.20 ± ---	MATERIAL NO.	SEE TABLE		DOCUMENT NO.	SD-34824-003
	0 PLACE ± --- ± ---	ANGULAR ± 1°				1 OF 5
		DRAFT WHERE APPLICABLE MUST REMAIN WITHIN DIMENSIONS	SIZE 1	THIS DRAWING CONTAINS INFORMATION THAT IS PROPRIETARY TO MOLEX INCORPORATED AND SHOULD NOT BE USED WITHOUT WRITTEN PERMISSION		

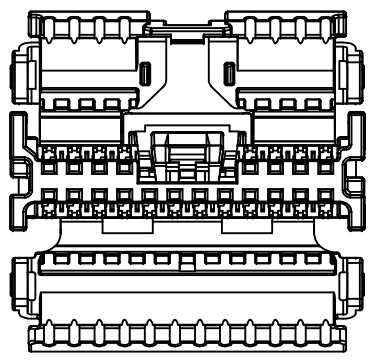

20 CKT BRIDGED RECEPTACLE W/CPA  
POLARIZATION OPTION A

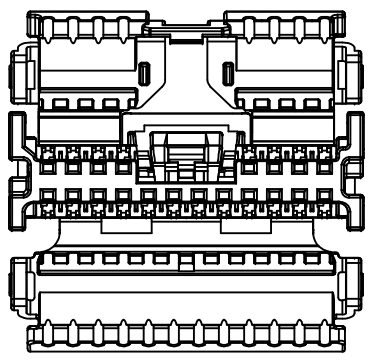

20 CKT BRIDGED RECEPTACLE W/CPA  
POLARIZATION OPTION B

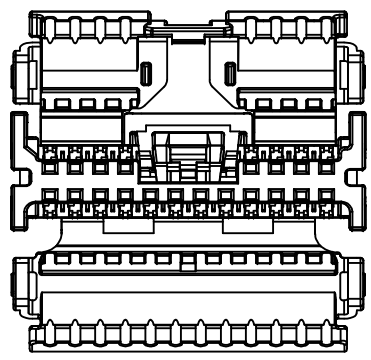

20 CKT BRIDGED RECEPTACLE W/CPA  
POLARIZATION OPTION C

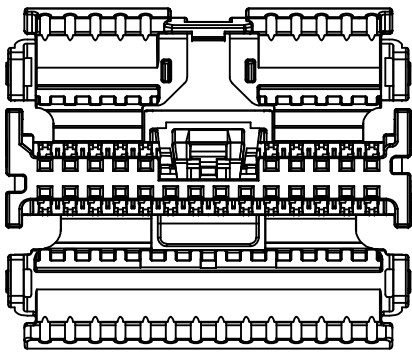

24 CKT BRIDGED RECEPTACLE W/CPA  
POLARIZATION OPTION A

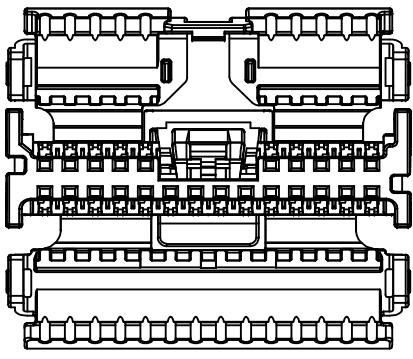

24 CKT BRIDGED RECEPTACLE W/CPA  
POLARIZATION OPTION B

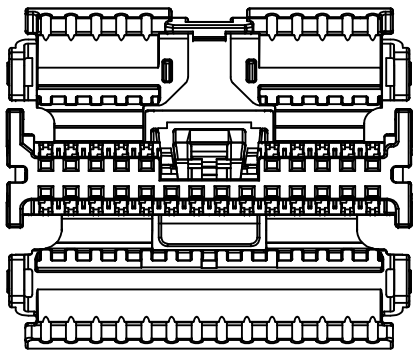

24 CKT BRIDGED RECEPTACLE W/CPA  
POLARIZATION OPTION C

UPDATED 4.8.12 P/N EC NO: UAU2016-0125 DRWNR: KHEMITT CHKD: APPR: RBAUMAN 2015/07/27	QUALITY SYMBOLS	GENERAL TOLERANCES (UNLESS SPECIFIED)	DIMENSION STYLE	SCALE	DESIGN UNITS	THIRD ANGLE PROJECTION	
	▽=0	mm INCH	MM ONLY	5:1	METRIC		
	▽=0	4 PLACES ± --- ± ---	DRAWN BY DATE			TITLE	
	▽=0	3 PLACES ± --- ± ---	MYOUNG01 2013/01/31	CHECKED BY DATE		MINI 50 SINGLE/DUAL ROW CPA-RECEPTACLE ASSEMBLY SALES DRAWING	
▽=0	2 PLACES ± 0.10 ± ---	APPROVED BY DATE				DOCUMENT NO.	
▽=0	1 PLACE ± 0.20 ± ---	RBAUMAN 2013/11/13	SEE TABLE			SD-34824-003	
	0 PLACE ± --- ± ---	ANGULAR ± 1°				SHEET NO.	
		DRAFT WHERE APPLICABLE MUST REMAIN WITHIN DIMENSIONS				2 OF 5	
						THIS DRAWING CONTAINS INFORMATION THAT IS PROPRIETARY TO MOLEX INCORPORATED AND SHOULD NOT BE USED WITHOUT WRITTEN PERMISSION	

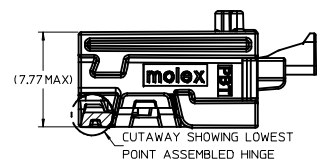
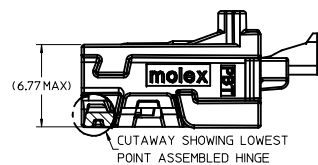
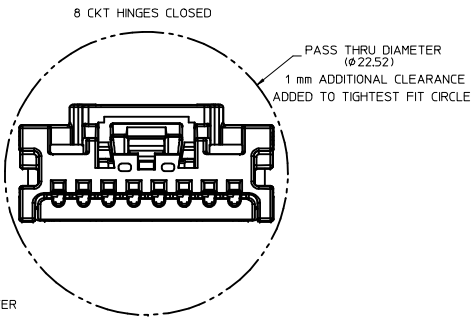
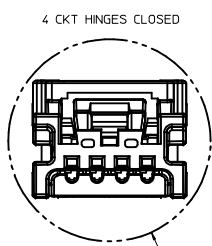
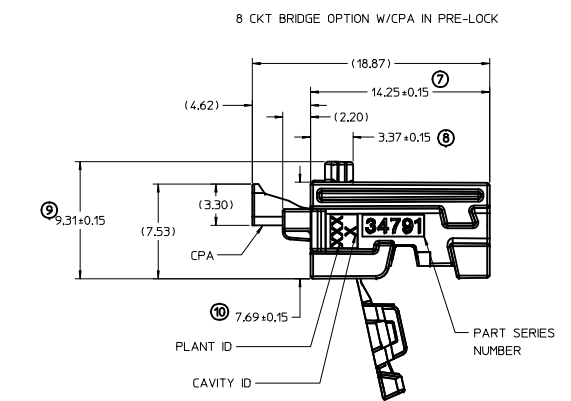
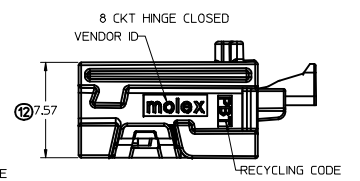
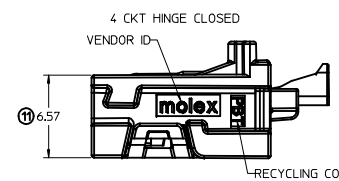
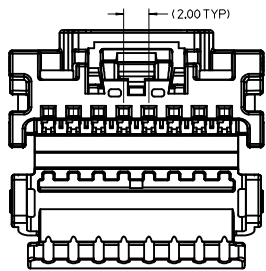
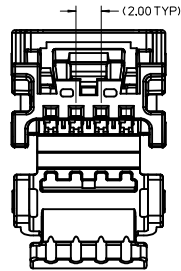
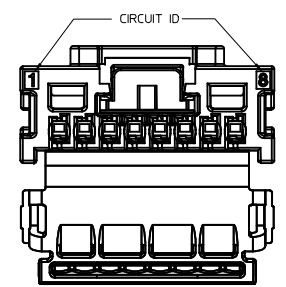
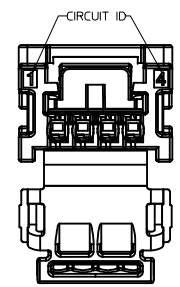
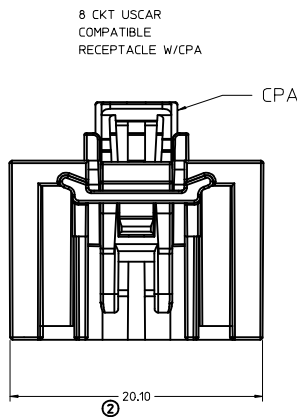
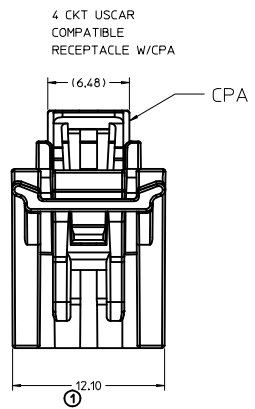
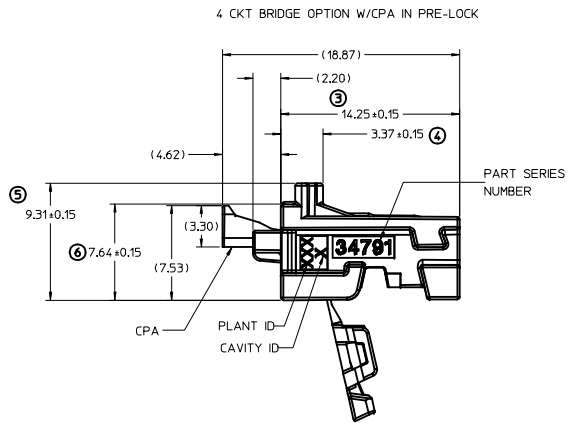

UPDATED 4.8.12 P/N EEC NO: UAU2016-0125 DRAWN BY: DRW:KHEMITT CHKD: APPR:RBAUMAN 2015/07/28	QUALITY SYMBOLS	GENERAL TOLERANCES (UNLESS SPECIFIED)	DIMENSION STYLE	SCALE	DESIGN UNITS	THIRD ANGLE PROJECTION
	▽=0	mm INCH	MM ONLY	5:1	METRIC	
	▽=0	4 PLACES ± --- ± ---	DRAWN BY DATE			TITLE
	▽=0	3 PLACES ± --- ± ---	MYOUNG01 2013/01/31	CHECKED BY DATE		
▽=0	2 PLACES ± 0.10 ± ---	APPROVED BY DATE				molex DOCUMENT NO. SD-34824-003 SHEET NO. 3 OF 5
▽=0	1 PLACE ± 0.20 ± ---	RBAUMAN 2013/11/13				
	0 PLACE ± --- ± ---	ANGULAR ± 1°	MATERIAL NO.			
		DRAFT WHERE APPLICABLE MUST REMAIN WITHIN DIMENSIONS	SEE TABLE			
			SIZE 1	THIS DRAWING CONTAINS INFORMATION THAT IS PROPRIETARY TO MOLEX INCORPORATED AND SHOULD NOT BE USED WITHOUT WRITTEN PERMISSION		

12 CKT USCAR COMPATIBLE RECEPTACLE W/CPA

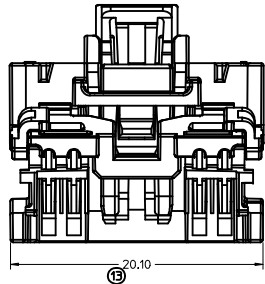

16 CKT RECEPTACLE W/CPA

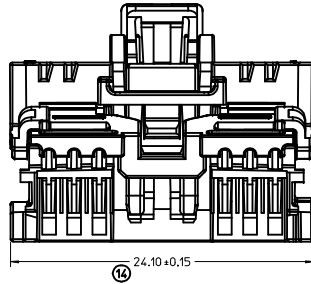

20 CKT RECEPTACLE W/CPA

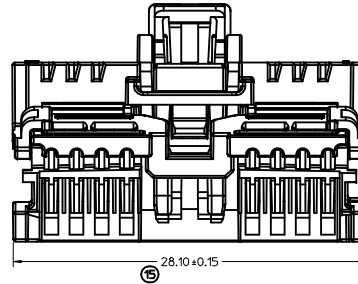

24 CKT RECEPTACLE W/CPA

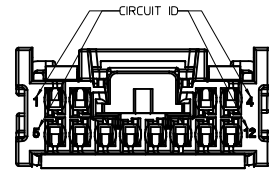
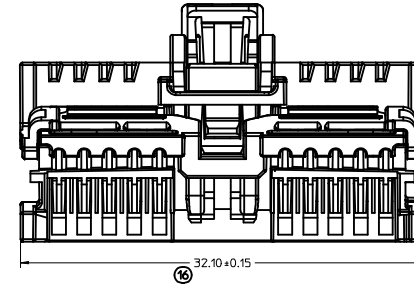

DUAL ROW LOCK BRIDGE OPTION

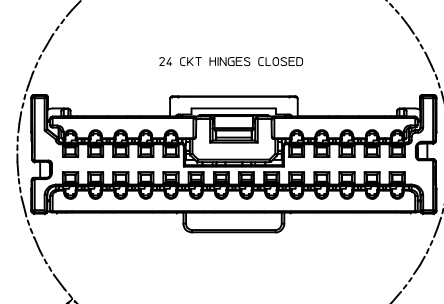
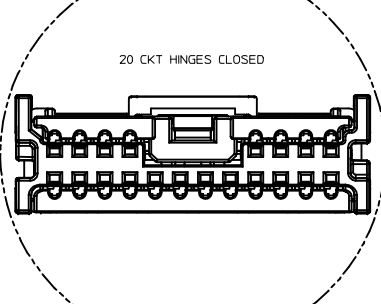
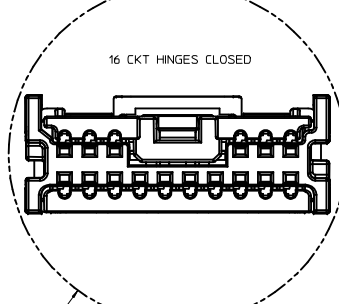
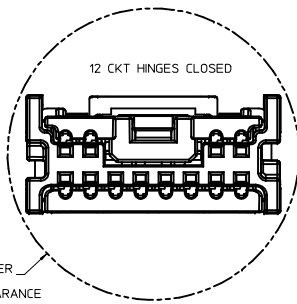
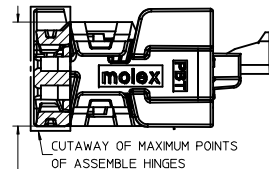
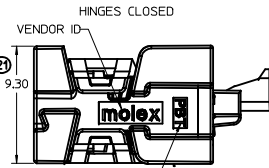
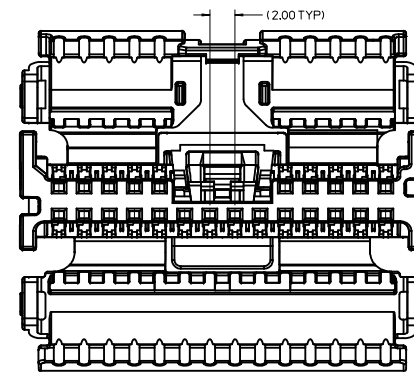
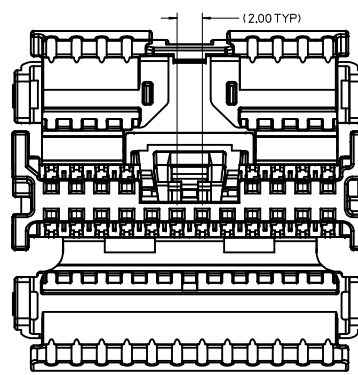
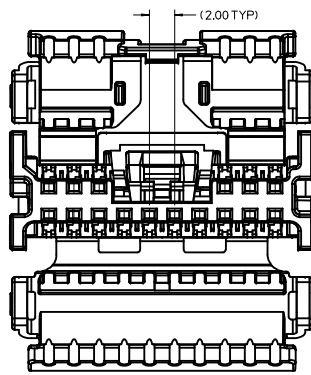
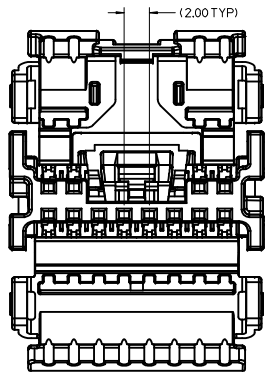
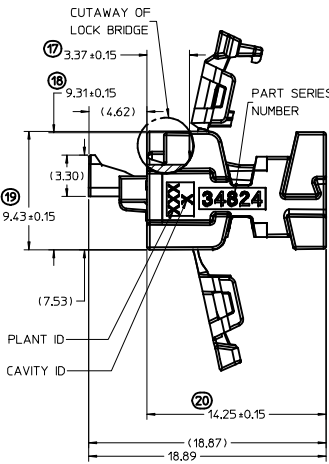

PASS THRU DIAMETER (Ø23.16)  
1 mm ADDITIONAL CLEARANCE ADDED TO TIGHTEST FIT CIRCLE

PASS THRU DIAMETER (Ø26.87)  
1 mm ADDITIONAL CLEARANCE ADDED TO TIGHTEST FIT CIRCLE

PASS THRU DIAMETER (Ø30.65)  
1 mm ADDITIONAL CLEARANCE ADDED TO TIGHTEST FIT CIRCLE

PASS THRU DIAMETER (Ø34.47)  
1 mm ADDITIONAL CLEARANCE ADDED TO TIGHTEST FIT CIRCLE

UPDATED 4.8.12 P/N EC NO: UAU2016-0125 DRAWN BY: DRWINKHEMITT CHKD: APPR:RBAUMAN 2015/07/28	QUALITY SYMBOLS	GENERAL TOLERANCES (UNLESS SPECIFIED)	DIMENSION STYLE	SCALE	DESIGN UNITS	THIRD ANGLE PROJECTION
	▽=0	mm INCH	MM ONLY	5:1	METRIC	
	▽=0	4 PLACES ± --- ± ---	DRAWN BY DATE			
	▽=0	3 PLACES ± --- ± ---	MYOUNG01 2013/01/31			
	2 PLACES ± 0.10 ± ---	CHECKED BY DATE				TITLE
	1 PLACE ± 0.20 ± ---	APPROVED BY DATE				MINI 50 SINGLE/DUAL ROW CPA-RECEPTACLE ASSEMBLY SALES DRAWING
	0 PLACE ± --- ± ---	RBAUMAN 2013/11/13				<b>molex</b>
	ANGULAR ± 1°	MATERIAL NO.	SEE TABLE	DOCUMENT NO.	SD-34824-003	SHEET NO. 4 OF 5
	DRAFT WHERE APPLICABLE MUST REMAIN WITHIN DIMENSIONS	SIZE	THIS DRAWING CONTAINS INFORMATION THAT IS PROPRIETARY TO MOLEX INCORPORATED AND SHOULD NOT BE USED WITHOUT WRITTEN PERMISSION			

SINGLE ROW ASSEMBLY  
(RECEPTACLE WITH CPA)

MOLEX MATERIAL NUMBER BULK PACKAGING PK-31301-538	GENERAL MOTORS PART NUMBER	CONFIGURATION	CIRCUIT	POL	COLOR	MATING COMPONENT					
						SURFACE MOUNT TECHNOLOGY (SMT) HEADER		VERTICAL THRU HOLE HEADER		RIGHT ANGLE THRU HOLE HEADERS	
						TAPE AND REEL PACKAGING PK-31301-786	TUBE PACKAGING PK-31301-688	TRAY PACKAGING PK-31301-440	TUBE PACKAGING PK-31301-688	TRAY PACKAGING PK-31301-440	TUBE PACKAGING PK-31301-688
34791-5140	13507113	USCAR COMPATIBLE	4	A	BLACK	34912-8040	34912-9040	34792-0040	34792-9040	34793-0040	34793-9040
34791-5141	13507115	USCAR COMPATIBLE	4	B	LIGHT GRAY	34912-8041	34912-9041	34792-0041	34792-9041	34793-0041	34793-9041
34791-5142	13507116	USCAR COMPATIBLE	4	C	DARK GRAY	34912-8042	34912-9042	34792-0042	34792-9042	34793-0042	34793-9042
34791-5143	13507117	USCAR COMPATIBLE	4	D	GREEN	34912-8043	34912-9043	34792-0043	34792-9043	34793-0043	34793-9043
34791-5180	13507118	USCAR COMPATIBLE	8	A	BLACK	34912-8080	34912-9080	34792-0080	34792-9080	34793-0080	34793-9080
34791-5181	13507119	USCAR COMPATIBLE	8	B	LIGHT GRAY	34912-8081	34912-9081	34792-0081	34792-9081	34793-0081	34793-9081
34791-5182	13507120	USCAR COMPATIBLE	8	C	DARK GRAY	34912-8082	34912-9082	34792-0082	34792-9082	34793-0082	34793-9082

DUAL ROW ASSEMBLY  
(RECEPTACLE WITH CPA)

MOLEX MATERIAL NUMBER BULK PACKAGING PK-31301-538	GENERAL MOTORS PART NUMBER	CONFIGURATION	CIRCUIT	POL	COLOR	MATING COMPONENT					
						SURFACE MOUNT TECHNOLOGY (SMT) HEADER		VERTICAL THRU HOLE HEADER		RIGHT ANGLE THRU HOLE HEADER	
						TAPE AND REEL PACKAGING PK-31301-786	TUBE PACKAGING PK-31301-688	TRAY PACKAGING PK-31301-440	TUBE PACKAGING PK-31301-688	TRAY PACKAGING PK-31301-440	TUBE PACKAGING PK-31301-688
34824-5124	13507121	USCAR COMPATIBLE	12	A	BLACK	34897-8120	34897-9120	34825-0124	34825-9124	34826-0124	34826-9124
34824-5125	13507122	USCAR COMPATIBLE	12	B	LIGHT GRAY	34897-8121	34897-9121	34825-0125	34825-9125	34826-0125	34826-9125
34824-5126	13507114	USCAR COMPATIBLE	12	C	DARK GRAY	34897-8122	34897-9122	34825-0126	34825-9126	34826-0126	34826-9126
34824-2160	N/A	MOLEX	16	A	BLACK	34897-8160	34897-9160	34825-0160	34825-9160	34826-0160	34826-9160
34824-2161	N/A	MOLEX	16	B	LIGHT GRAY	34897-8161	34897-9161	34825-0161	34825-9161	34826-0161	34826-9161
34824-2162	N/A	MOLEX	16	C	DARK GRAY	34897-8162	34897-9162	34825-0162	34825-9162	34826-0162	34826-9162
34824-2200	13596105	MOLEX	20	A	BLACK	34897-8200	34897-9200	34825-0200	34825-9200	34826-0200	34826-9200
34824-2201	13596106	MOLEX	20	B	LIGHT GRAY	34897-8201	34897-9201	34825-0201	34825-9201	34826-0201	34826-9201
34824-2202	13596107	MOLEX	20	C	DARK GRAY	34897-8202	34897-9202	34825-0202	34825-9202	34826-0202	34826-9202
34824-2240	N/A	MOLEX	24	A	BLACK	34897-8240	34897-9240	34825-0240	34825-9240	34826-0240	34826-9240
34824-2241	N/A	MOLEX	24	B	LIGHT GRAY	34897-8241	34897-9241	34825-0241	34825-9241	34826-0241	34826-9241
34824-2242	N/A	MOLEX	24	C	DARK GRAY	34897-8242	34897-9242	34825-0242	34825-9242	34826-0242	34826-9242

\*NOTE: MOLEX CONFIGURATION CONSISTS OF AN EXPANSION OF THE 12CKT USCAR-COMPATIBLE CONFIGURATION TO ALLOW FOR 16, 20, AND 24 CIRCUITS

MINI50 CPA (APPLIES TO SINGLE AND DUAL ROW BRIDGED RECEPTACLE CONNECTORS)

MATERIAL NUMBER	COLOR	MATING COMPONENT
34824-7000	NATURAL	SEE CHARTS ABOVE

CTX50 UNSEALED RECEPTACLE TERMINALS

PART NUMBER		MATERIAL	WIRE GAGE (mm <sup>2</sup> )	GRIP
D-WIND (LEFT PAYOFF)	B-WIND (RIGHT PAYOFF)			
560023-0448	560023-0450	COPPER ALLOY	0.35	LARGE
560023-0421	560023-0423	COPPER ALLOY	0.22	MEDIUM
560023-0422	560023-0424	COPPER ALLOY	0.13	SMALL

UPDATED 4.8.12 P/N ELEC NO: UAU2016-0125 DRAWN BY: DRANKHEMIT CHKD: APPR:RBAUMAN 2015/07/28	QUALITY SYMBOLS	GENERAL TOLERANCES (UNLESS SPECIFIED)	DIMENSION STYLE	SCALE	DESIGN UNITS	THIRD ANGLE PROJECTION
	▽=0	mm INCH	MM ONLY	5:1	METRIC	
	▽=0	4 PLACES ± --- ± ---	DRAWN BY DATE			
	▽=0	3 PLACES ± --- ± ---	CHECKED BY DATE	MYOUNGO1 2013/01/31		
	2 PLACES ± 0.10 ± ---	APPROVED BY DATE				MINI 50 SINGLE/DUAL ROW CPA-RECEPTACLE ASSEMBLY SALES DRAWING <b>molex</b>
	1 PLACE ± 0.20 ± ---	RBAUMAN 2013/11/13				
	0 PLACE ± --- ± ---	ANGULAR ± 1°	MATERIAL NO.	DOCUMENT NO.	SHEET NO.	
	DRAFT WHERE APPLICABLE MUST REMAIN WITHIN DIMENSIONS	SEE TABLE		SD-34824-003	5 OF 5	
		THIS DRAWING CONTAINS INFORMATION THAT IS PROPRIETARY TO MOLEX INCORPORATED AND SHOULD NOT BE USED WITHOUT WRITTEN PERMISSION				