

## FEATURES

- Physical layer CAN transceiver
- 5 V operation on  $V_{CC}$
- Complies with ISO 11898 standard
- High speed data rates up to 1 Mbps
- Short-circuit protection on CANH and CANL against shorts to power/ground in 24 V systems
- Unpowered nodes do not disturb the bus
- Connect 110 or more nodes on the bus
- Slope control for reduced EMI
- Thermal shutdown protection
- Low current standby mode
- Industrial operating temperature range ( $-40^{\circ}\text{C}$  to  $+125^{\circ}\text{C}$ )
- Available in 8-lead SOIC package

## APPLICATIONS

- CAN data buses
- Industrial field networks
- DeviceNet applications
- CanOpen, CanKingdom

## GENERAL DESCRIPTION

The [ADM3051](#) is a controller area network (CAN) physical layer transceiver allowing a protocol layer CAN controller to access the physical layer bus. The [ADM3051](#) complies with the ISO 11898 standard. It is capable of running at data rates up to 1 Mbps.

The device has current-limiting and thermal shutdown features to protect against output short circuits and situations where the bus may be shorted to ground or power terminals in 24 V bus power systems. The part is fully specified over the industrial temperature range of  $-40^{\circ}\text{C}$  to  $+125^{\circ}\text{C}$  and is available in an 8-lead SOIC package.

## FUNCTIONAL BLOCK DIAGRAM

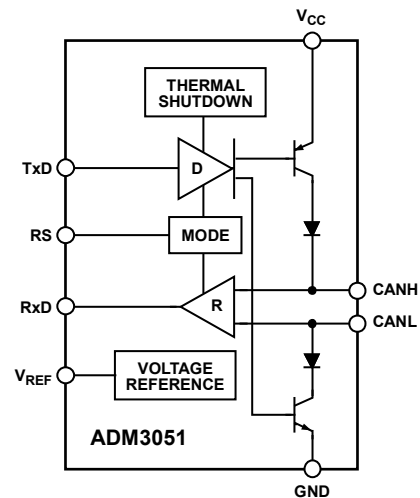

Figure 1.

10028-001

Three operating modes are available: high speed, slope control, and standby. Pin 8 (RS) is used to select the operating mode. The low current standby mode can be selected by applying a logic high to RS.

The device can be set to operate with slope control to limit EMI by connecting RS with a resistor to ground to modify the rise and fall of slopes. This mode facilitates the use of unshielded cables. Alternatively, disabling slope control by connecting RS to ground allows high speed operation. Shielded cables or other measures to control EMI are necessary in this mode.

# ADM3051\* PRODUCT PAGE QUICK LINKS

Last Content Update: 02/23/2017

---

## COMPARABLE PARTS

View a parametric search of comparable parts.

## EVALUATION KITS

- ADM3051 Evaluation Board

## DOCUMENTATION

### Application Notes

- AN-1123: Controller Area Network (CAN) Implementation Guide
- AN-1176: Component Footprints and Symbols in the Binary .Bxl File Format
- AN-1179: Junction Temperature Calculation for Analog Devices RS-485/RS-422, CAN, and LVDS/M-LVDS Transceivers

### Data Sheet

- ADM3051: High Speed Industrial CAN Transceiverwith Bus Protection for 24 V Systems

### User Guides

- UG-330: Evaluation Board for the ADM3051 CAN Transceiver

## TOOLS AND SIMULATIONS

- ADM3051 IBIS Model

## DESIGN RESOURCES

- ADM3051 Material Declaration
- PCN-PDN Information
- Quality And Reliability
- Symbols and Footprints

## DISCUSSIONS

View all ADM3051 EngineerZone Discussions.

## SAMPLE AND BUY

Visit the product page to see pricing options.

## TECHNICAL SUPPORT

Submit a technical question or find your regional support number.

## DOCUMENT FEEDBACK

Submit feedback for this data sheet.

---

**TABLE OF CONTENTS**

Features .....	1	Typical Performance Characteristics .....	7
Applications.....	1	Test Circuits and Switching Characteristics.....	11
Functional Block Diagram .....	1	Circuit Description.....	13
General Description .....	1	CAN Transceiver Operation .....	13
Revision History .....	2	Operational Modes .....	13
Specifications.....	3	Truth Tables.....	13
Timing Specifications .....	4	Thermal Shutdown .....	13
Absolute Maximum Ratings.....	5	Applications Information .....	14
ESD Caution.....	5	Outline Dimensions .....	15
Pin Configuration and Function Descriptions.....	6	Ordering Guide .....	15

**REVISION HISTORY**

**5/2016—Rev.0 to Rev. A**

Changes to Ordering Guide .....	15
---------------------------------	----

**9/2011—Revision 0: Initial Version**

## SPECIFICATIONS

All voltages relative to ground (Pin 2);  $4.5\text{ V} \leq V_{CC} \leq 5.5\text{ V}$ .  $T_A = -40^\circ\text{C}$  to  $+125^\circ\text{C}$ ,  $R_L = 60\ \Omega$ ,  $I_{RS} > -10\ \mu\text{A}$ , unless otherwise noted. All typical specifications are at  $T_A = 25^\circ\text{C}$ ,  $V_{CC} = 5\text{ V}$ , unless otherwise noted.

Table 1.

Parameter	Symbol	Min	Typ	Max	Unit	Test Conditions/Comments
<b>SUPPLY CURRENT</b>						
Dominant State	$I_{CC}$			78	mA	$V_{TXD} = 1\text{ V}$
Recessive State				10	mA	$V_{TXD} = 4\text{ V}$ ; $R_{SLOPE} = 47\text{ k}\Omega$
Standby State			275		$\mu\text{A}$	$V_{RS} = V_{CC}$ , $I_{TXD} = I_{RXD} = I_{VREF} = 0\text{ mA}$ , $T_A < 90^\circ\text{C}$
<b>DRIVER</b>						
Logic Inputs						
Input Voltage High	$V_{IH}$	$0.7 V_{CC}$		$V_{CC} + 0.3$	V	Output recessive
Input Voltage Low	$V_{IL}$	-0.3		$+0.3 V_{CC}$	V	Output dominant
CMOS Logic Input Current High	$I_{IH}$	-200		+30	$\mu\text{A}$	$V_{TXD} = 4\text{ V}$
CMOS Logic Input Current Low	$I_{IL}$	-100		-600	$\mu\text{A}$	$V_{TXD} = 1\text{ V}$
Differential Outputs						
Recessive Bus Voltage	$V_{CANH}, V_{CANL}$	2.0		3.0	V	$V_{TXD} = 4\text{ V}$ , $R_L = \infty$ , see Figure 23
Off-State Output Leakage Current	$I_{LO}$	-2		+2	mA	$-2\text{ V} < (V_{CANL}, V_{CANH}) < 7\text{ V}$
	$I_{LO}$	-10		+10	mA	$-5\text{ V} < (V_{CANL}, V_{CANH}) < 36\text{ V}$
CANH Output Voltage	$V_{CANH}$	3.0		4.5	V	$V_{TXD} = 1\text{ V}$ , see Figure 23
CANL Output Voltage	$V_{CANL}$	0.5		2.0	V	$V_{TXD} = 1\text{ V}$ , see Figure 23
Differential Output Voltage	$V_{OD}$	1.5		3.0	V	$V_{TXD} = 1\text{ V}$ , see Figure 23
	$V_{OD}$	1.5			V	$V_{TXD} = 1\text{ V}$ , $R_L = 45\ \Omega$ , see Figure 23
Short-Circuit Current, CANH	$I_{SCCANH}$	-500		+50	mV	$V_{TXD} = 4\text{ V}$ , $R_L = \infty$ , see Figure 23
	$I_{SCCANH}$		-100		mA	$V_{CANH} = -5\text{ V}$
Short-Circuit Current, CANL	$I_{SCCANL}$			200	mA	$V_{CANL} = -36\text{ V}$
	$I_{SCCANL}$				mA	$V_{CANL} = 36\text{ V}$
<b>RECEIVER</b>						
Differential Inputs						
Voltage Recessive	$V_{IDR}$	-1.0		+0.5	V	$-2\text{ V} < V_{CANL}, V_{CANH} < 7\text{ V}$ , see Figure 25, $V_{CC} = 4.75\text{ V}$ to $5.25\text{ V}$ , $C_L = 30\text{ pF}$
		-1.0		+0.4	V	$-7\text{ V} < V_{CANL}, V_{CANH} < 12\text{ V}$ , see Figure 25, $C_L = 30\text{ pF}$
Voltage Dominant	$V_{IDD}$	0.9		5.0	V	$-2\text{ V} < V_{CANL}, V_{CANH} < 7\text{ V}$ , see Figure 25, $V_{CC} = 4.75\text{ V}$ to $5.25\text{ V}$ , $C_L = 30\text{ pF}$
		1.0		5.0	V	$-7\text{ V} < V_{CANL}, V_{CANH} < 12\text{ V}$ , see Figure 25, $C_L = 30\text{ pF}$ <sup>1</sup>
Input Voltage Hysteresis	$V_{HYS}$		150		mV	See Figure 26
CANH, CANL Input Resistance	$R_{IN}$	5		25	k $\Omega$	
Differential Input Resistance	$R_{DIFF}$	20		100	k $\Omega$	
Logic Outputs						
Output Voltage High	$V_{OH}$	$0.8 V_{CC}$		$V_{CC}$	V	$I_{OUT} = -100\ \mu\text{A}$
Output Voltage Low	$V_{OL}$	0		$0.2 V_{CC}$	V	$I_{OUT} = 1\text{ mA}$
	$V_{OL}$	0		1.5	V	$I_{OUT} = 10\text{ mA}$
Short-Circuit Current	$ I_{OS} $			120	mA	$V_{OUT} = \text{GND or } V_{CC}$
<b>VOLTAGE REFERENCE</b>						
Reference Output Voltage	$V_{REF}$	2.025		3.025	V	$V_{RS} = 1\text{ V}$ , $ I_{REF}  = 50\ \mu\text{A}$
	$V_{REF}$	$0.4 V_{CC}$		$0.6 V_{CC}$	V	$V_{RS} = 4\text{ V}$ , $ I_{REF}  = 5\ \mu\text{A}$
<b>STANDBY/SLOPE CONTROL</b>						
Input Voltage for Standby Mode	$V_{STB}$	$0.75 V_{CC}$			V	
Current for Slope Control Mode	$I_{SLOPE}$	-10		-200	$\mu\text{A}$	
Slope Control Mode Voltage	$V_{SLOPE}$	$0.4 V_{CC}$		$0.6 V_{CC}$	V	

<sup>1</sup> In standby,  $V_{CC} = 4.75\text{ V}$  to  $5.25\text{ V}$ .

**TIMING SPECIFICATIONS**

All voltages are relative to ground (Pin 2);  $4.5\text{ V} \leq V_{CC} \leq 5.5\text{ V}$ .  $T_A = -40^\circ\text{C}$  to  $+125^\circ\text{C}$ , unless otherwise noted.

Table 2.

Parameter	Symbol	Min	Typ	Max	Unit	Test Conditions/Comments
<b>DRIVER</b>						
Maximum Data Rate		1			Mbps	$V_{RS} = 1\text{ V}$
Propagation Delay from TxD On to Bus Active	$t_{onTxD}$			50	ns	$V_{RS} = 1\text{ V}$ , $R_L = 60\ \Omega$ , $C_L = 100\text{ pF}$ , see Figure 24, Figure 27
Propagation Delay from TxD Off to Bus Inactive	$t_{offTxD}$		40	80	ns	$V_{RS} = 1\text{ V}$ , $R_L = 60\ \Omega$ , $C_L = 100\text{ pF}$ , see Figure 24, Figure 27
<b>RECEIVER</b>						
Propagation Delay from TxD On to Receiver Active	$t_{onRxD}$		55	120	ns	$V_{RS} = 1\text{ V}$ , $R_L = 60\ \Omega$ , $C_L = 100\text{ pF}$ , see Figure 24, Figure 27
			440	600	ns	$R_{SLOPE} = 47\text{ k}\Omega$ , $R_L = 60\ \Omega$ , $C_L = 100\text{ pF}$ , see Figure 24, Figure 27
Propagation Delay from TxD Off to Receiver Inactive	$t_{offRxD}$		90	190	ns	$R_{SLOPE} = 0\ \Omega$ , $R_L = 60\ \Omega$ , $C_L = 100\text{ pF}$ , see Figure 24, Figure 27
			290	400	ns	$R_{SLOPE} = 47\text{ k}\Omega$ , $R_L = 60\ \Omega$ , $C_L = 100\text{ pF}$ , see Figure 24, Figure 27
Bus Dominant to RxD Low	$t_{dRxDL}$			3	$\mu\text{s}$	$V_{RS} = 4\text{ V}$ , $V_{TxD} = 4\text{ V}$ , $R_L = 60\ \Omega$ , $C_L = 100\text{ pF}$ , see Figure 24, Figure 29
CANH, CANL Slew Rate	$ SR $		7		$\text{V}/\mu\text{s}$	$R_{SLOPE} = 47\text{ k}\Omega$ , $R_L = 60\ \Omega$ , $C_L = 100\text{ pF}$ , see Figure 24, Figure 27
TIME TO WAKE-UP FROM STANDBY	$t_{WAKE}$			20	$\mu\text{s}$	$V_{TxD} = 1\text{ V}$ , see Figure 28

## ABSOLUTE MAXIMUM RATINGS

Table 3.

Parameter	Rating
$V_{CC}$	-0.3 V to +7 V
Digital Input Voltage TxD	-0.3 V to $V_{CC} + 0.3$ V
Digital Output Voltage RxD	-0.3 V to $V_{CC} + 0.3$ V
CANH, CANL	-36 V to +36 V
$V_{REF}$	-0.3 V to $V_{CC} + 0.3$ V
RS	-0.3 V to $V_{CC} + 0.3$ V
Operating Temperature Range	-40°C to +125°C
Storage Temperature Range	-55°C to +150°C
ESD (Human Body Model) on All Pins	4 kV
Lead Temperature	
Soldering (10 sec)	300°C
Vapor Phase (60 sec)	215°C
Infrared (15 sec)	220°C
$\theta_{JA}$ Thermal Impedance	110°C/W
$T_J$ Junction Temperature	150°C

Stresses at or above those listed under Absolute Maximum Ratings may cause permanent damage to the product. This is a stress rating only; functional operation of the product at these or any other conditions above those indicated in the operational section of this specification is not implied. Operation beyond the maximum operating conditions for extended periods may affect product reliability.

### ESD CAUTION



#### ESD (electrostatic discharge) sensitive device.

Charged devices and circuit boards can discharge without detection. Although this product features patented or proprietary protection circuitry, damage may occur on devices subjected to high energy ESD. Therefore, proper ESD precautions should be taken to avoid performance degradation or loss of functionality.

## PIN CONFIGURATION AND FUNCTION DESCRIPTIONS

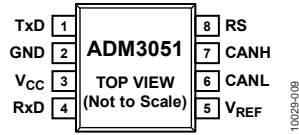

Figure 2. Pin Configuration

Table 4. Pin Function Descriptions

Pin No.	Mnemonic	Description
1	TxD	Driver Input Data.
2	GND	Ground.
3	V <sub>CC</sub>	Power Supply. This pin requires a decoupling capacitor to GND of 100 nF.
4	RxD	Receiver Output Data.
5	V <sub>REF</sub>	Reference Voltage Output.
6	CANL	Low Level CAN Voltage Input/Output.
7	CANH	High Level CAN Voltage Input/Output.
8	RS	Slope Resistor Input.

### TYPICAL PERFORMANCE CHARACTERISTICS

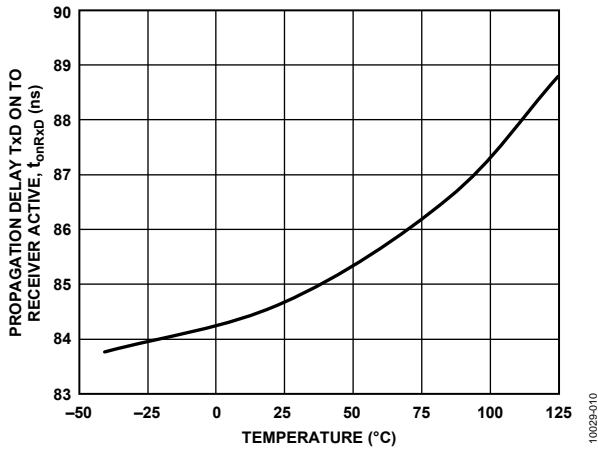

Figure 3. Propagation Delay from TxD On to Receiver Active vs. Temperature

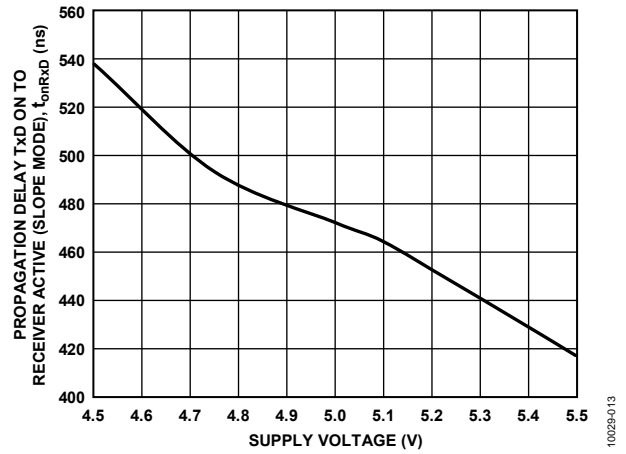

Figure 6. Propagation Delay (Slope Control Mode,  $R_{SLOPE} = 47\text{ k}\Omega$ ) from TxD On to Receiver Active vs. Supply Voltage

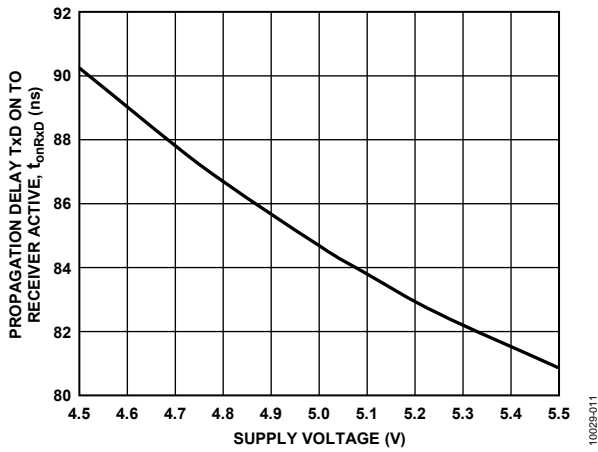

Figure 4. Propagation Delay from TxD On to Receiver Active vs. Supply Voltage

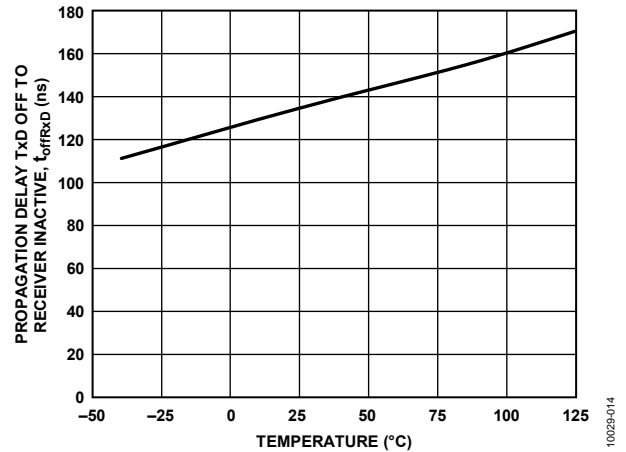

Figure 7. Propagation Delay from TxD Off to Receiver Inactive vs. Temperature

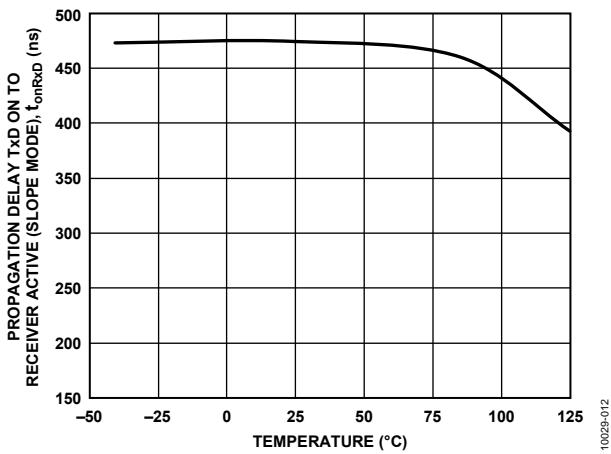

Figure 5. Propagation Delay (Slope Control Mode,  $R_{SLOPE} = 47\text{ k}\Omega$ ) from TxD On to Receiver Active vs. Temperature

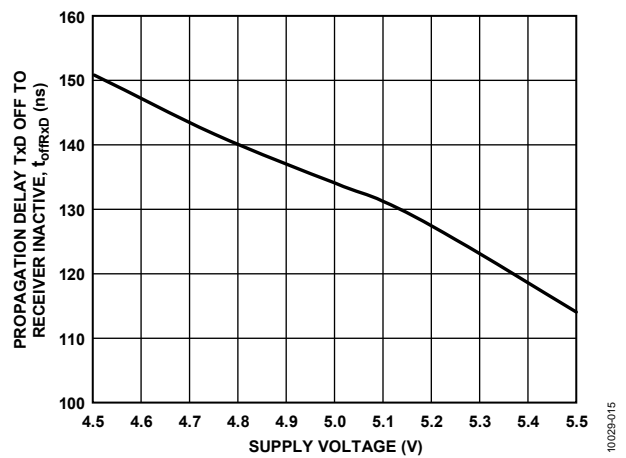

Figure 8. Propagation Delay from TxD Off to Receiver Inactive vs. Supply Voltage



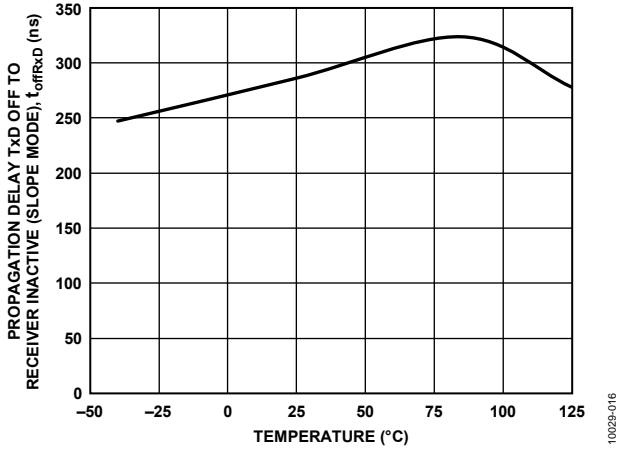

Figure 9. Propagation Delay (Slope Control Mode,  $R_{SLOPE} = 47\text{ k}\Omega$ ) from TxD Off to Receiver Inactive vs. Temperature

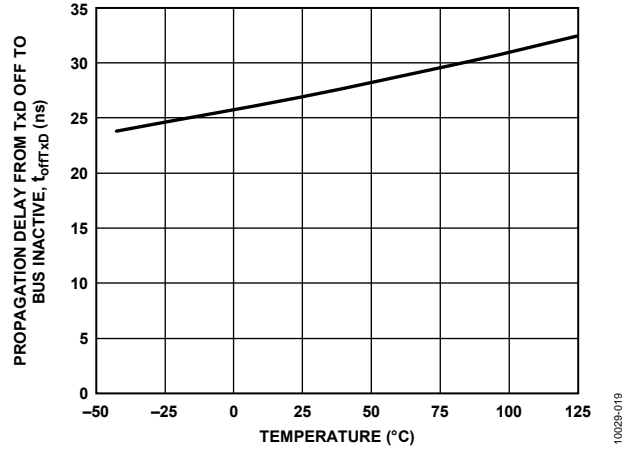

Figure 12. Propagation Delay from TxD Off to Bus Inactive vs. Temperature

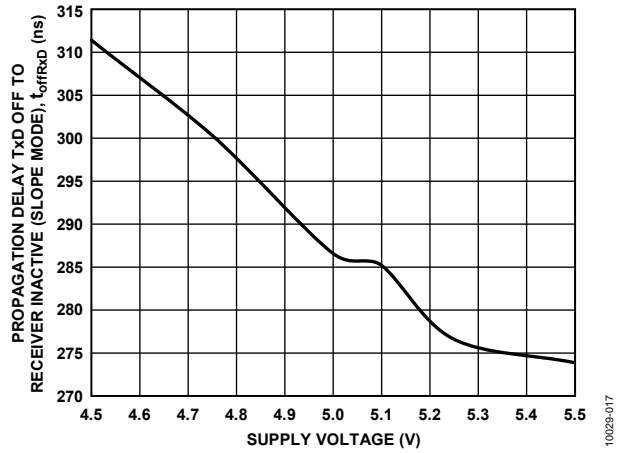

Figure 10. Propagation Delay (Slope Control Mode,  $R_{SLOPE} = 47\text{ k}\Omega$ ) from TxD Off to Receiver Inactive vs. Supply Voltage

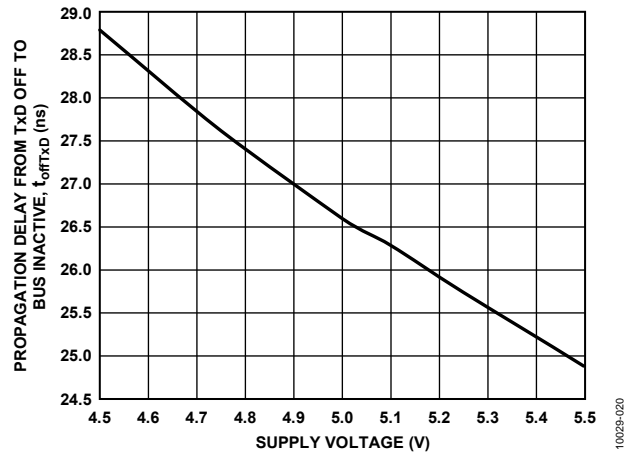

Figure 13. Propagation Delay from TxD Off to Bus Inactive vs. Supply Voltage

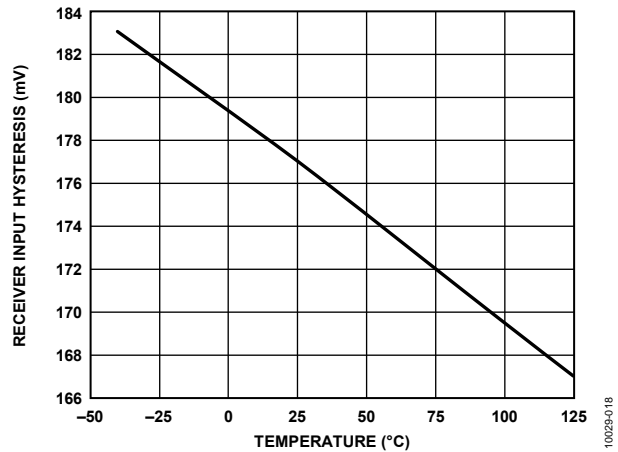

Figure 11. Receiver Input Hysteresis vs. Temperature

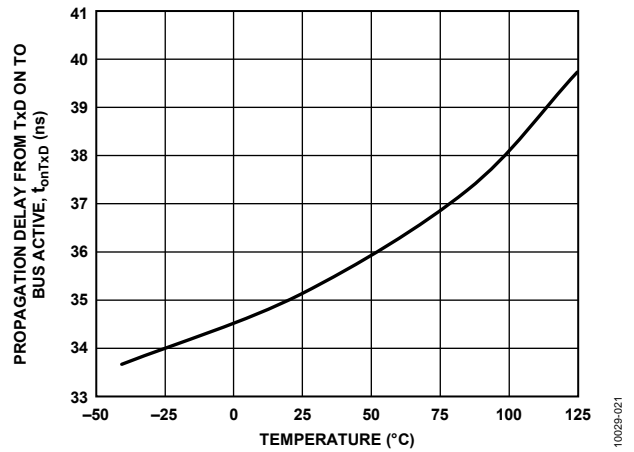

Figure 14. Propagation Delay from TxD On to Bus Active vs. Temperature

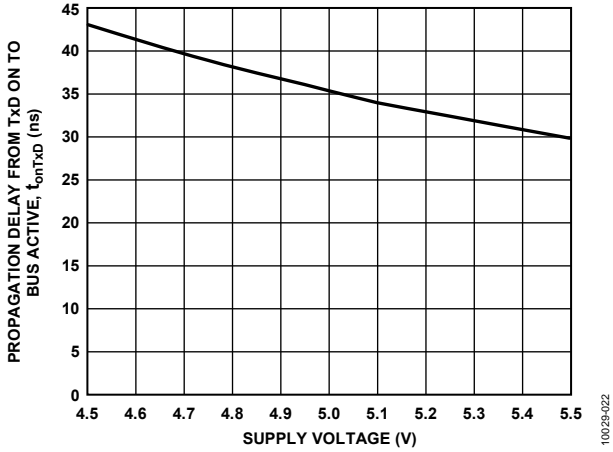

Figure 15. Propagation Delay from TxD On to Bus Active vs. Supply Voltage

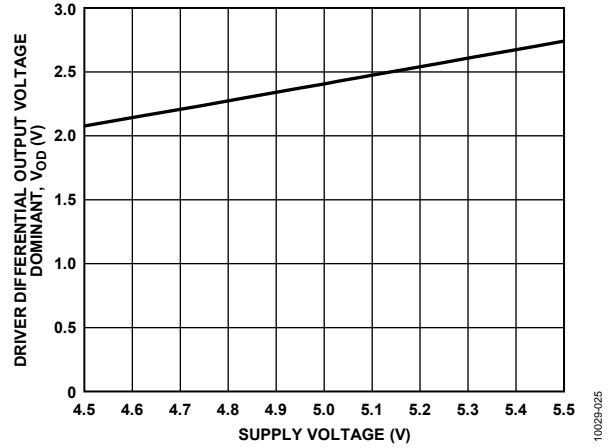

Figure 18. Driver Differential Output Voltage Dominant vs. Supply Voltage

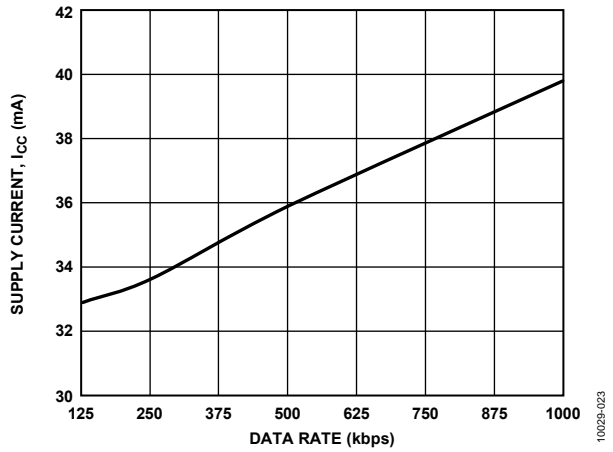

Figure 16. Supply Current ( $I_{CC}$ ) vs. Data Rate

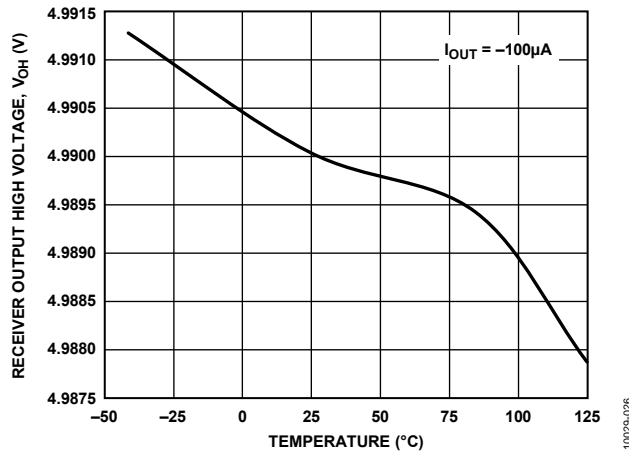

Figure 19. Receiver Output High Voltage vs. Temperature

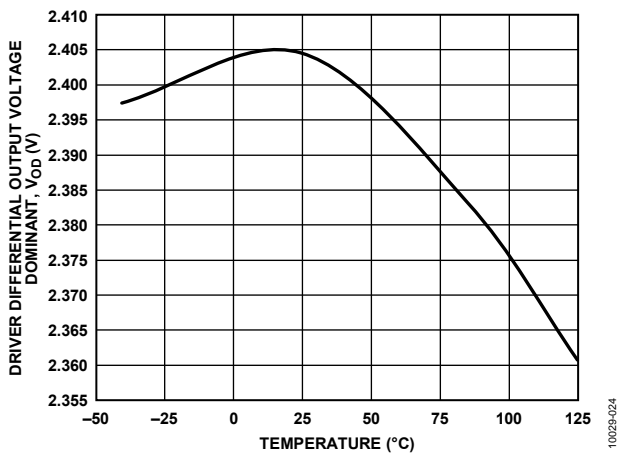

Figure 17. Driver Differential Output Voltage Dominant vs. Temperature

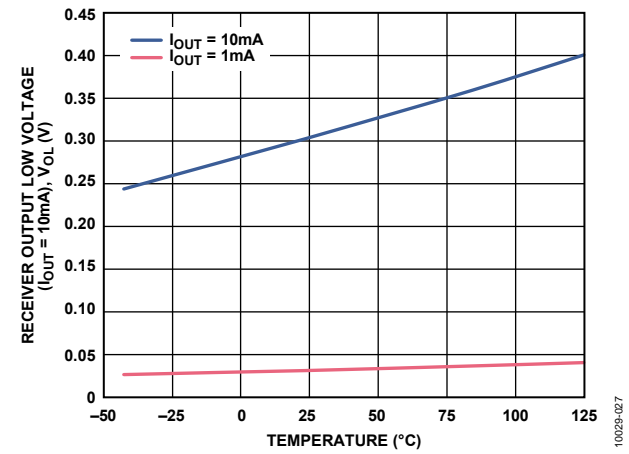

Figure 20. Receiver Output Low Voltage vs. Temperature

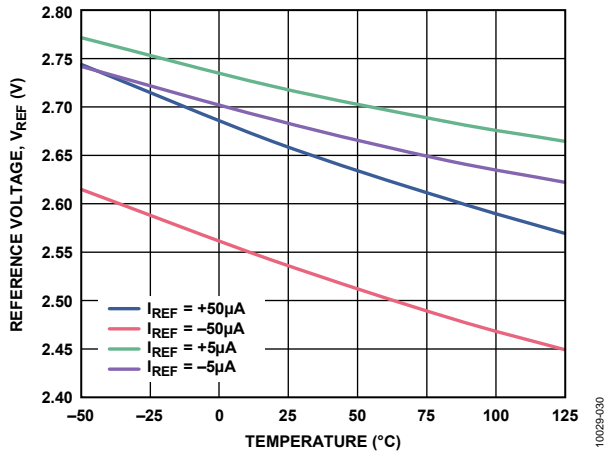

Figure 21.  $V_{REF}$  vs. Temperature

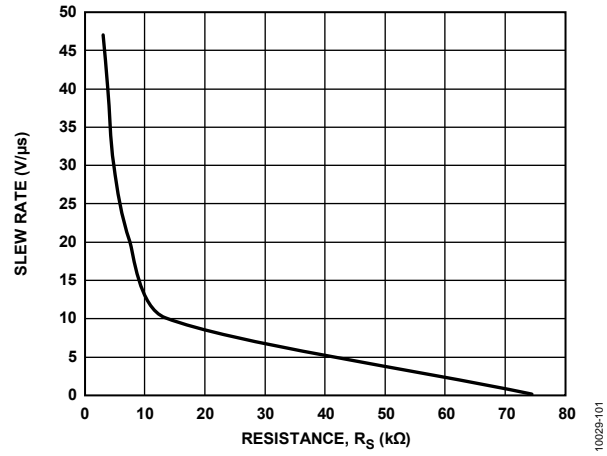

Figure 22. Driver Slew Rate vs. Resistance,  $R_{SLOPE}$

# TEST CIRCUITS AND SWITCHING CHARACTERISTICS

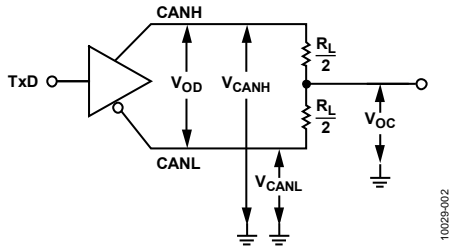

Figure 23. Driver Voltage Measurements

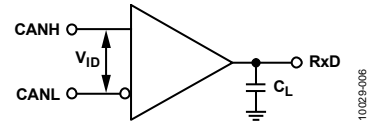

Figure 25. Receiver Voltage Measurements

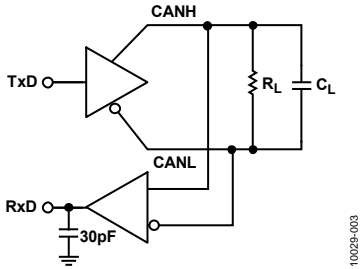

Figure 24. Switching Characteristics Measurements

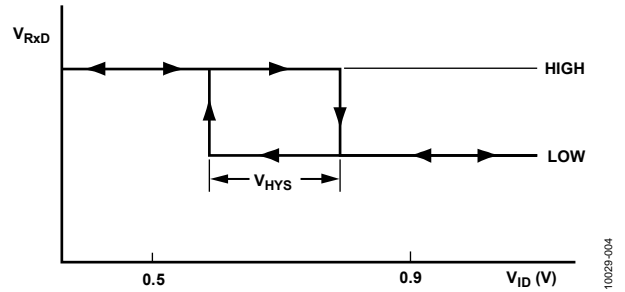

Figure 26. Receiver Input Hysteresis

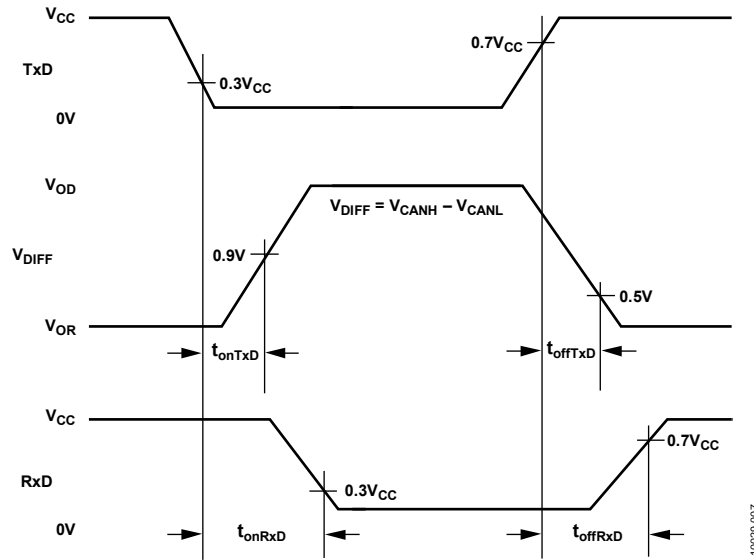
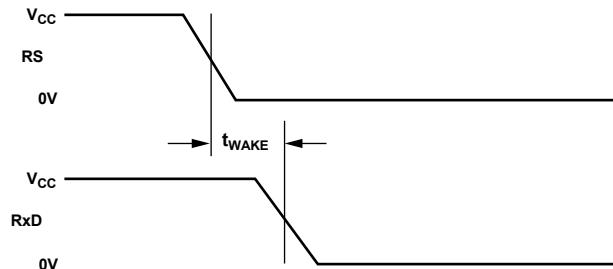
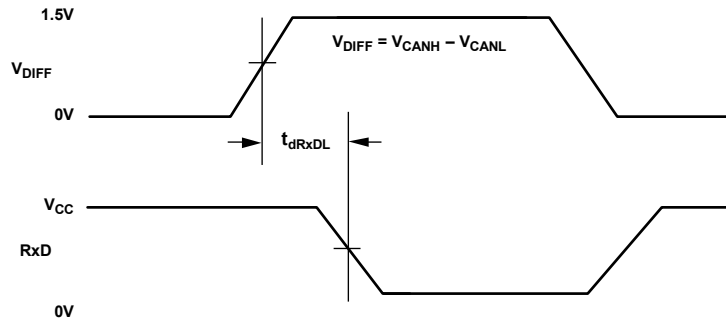

Figure 27. Driver and Receiver Propagation Delay



NOTES:  
1. TxD = 0V

Figure 28. Wake-Up Delay Returning from Standby Mode



NOTES:  
1.  $R_S = 4V$  (STANDBY MODE)  
2.  $T_{xD} = 4V$

10029-005

Figure 29. Bus Dominant to RxD Low (Standby Mode)

## CIRCUIT DESCRIPTION

### CAN TRANSCEIVER OPERATION

A CAN bus has two states: dominant and recessive. A dominant state is present on the bus when the differential voltage between CANH and CANL is greater than 0.9 V. A recessive state is present on the bus when the differential voltage between CANH and CANL is less than 0.5 V. During a dominant bus state, the CANH pin is high and the CANL pin is low. During a recessive bus state, both the CANH and CANL pins are in the high impedance state.

The driver drives CANH high and CANL low (dominant state) if a logic low is present on TxD. If a logic high is present on TxD, the driver output is placed in a high impedance state (recessive state). The driver output states are shown in Table 7.

The receiver output is low if the bus is in the dominant state and high if the bus is in the recessive state. If the differential voltage between CANH and CANL is between 0.5 V and 0.9 V, the bus state is indeterminate and the receiver output may be high or low. The receiver output states for given inputs are listed in Table 8.

### OPERATIONAL MODES

Three modes of operation are available: high speed, slope control, and standby. RS (Pin 8) allows modification of the operational mode by connecting the RS input through a resistor to ground, or directly to ground, or to a CAN controller, as shown in Figure 30.

With RS connected to ground, the output transistors switch on and off at the maximum rate possible in high speed mode, with no modification to the rise and fall slopes. EMI in this mode can be alleviated using shielded cables.

Alternatively, connecting RS to a resistor,  $R_{SLOPE}$ , allows slope control mode, with the value of the resistor modifying the rise and fall slopes. The reduced EMI allows the use of unshielded cables.

Applying a logic high to RS initiates a low current standby mode. The transmitter is disabled, and the receiver is connected to a low current. RxD goes low upon receiving dominant bits, allowing an attached microcontroller that detects this to wake the transceiver via Pin 8, which returns it to standard operation. The receiver is slower in standby mode and loses the first message at higher bit rates.

**Table 5. Mode Selection Using RS Pin (Pin 8)**

Mode	Condition to Force	Resulting Voltage/Current
Standby	$V_{RS} > 0.75 V_{CC}$	$-I_{RS} < 10 \mu A$
Slope Control	$10 \mu A < -I_{RS} < 200 \mu A$	$0.4 V_{CC} < V_{RS} < 0.6 V_{CC}$
High Speed	$V_{RS} < 0.3 V_{CC}$	$-I_{RS} < -500 \mu A$

### TRUTH TABLES

The truth tables in this section use the abbreviations found in Table 6.

**Table 6. Truth Table Abbreviations**

Letter	Description
H	High level
L	Low level
X	Don't care
I	Indeterminate
Z	High impedance (off)
NC	Disconnected

**Table 7. Transmitting**

Supply	Input	Outputs		
		State	CANH	CANL
V <sub>CC</sub>	TxD			
On	L	Dominant	H	L
On	H	Recessive	Z	Z
On	Z	Recessive	Z	Z
Off	X	Z	Z	Z

**Table 8. Receiving**

Supply	Inputs		Output
	V <sub>ID</sub> = CANH – CANL	Bus State	RxD
V <sub>CC</sub>			
On	$\geq 0.9 V$	Dominant	L
On	$\leq 0.5 V$	Recessive	H
On	$0.5 V < V_{ID} < 0.9 V$	I	I
On	Inputs open	Recessive	H
Off	X	X	I

### THERMAL SHUTDOWN

The ADM3051 contains thermal shutdown circuitry that protects the part from excessive power dissipation during fault conditions. Shorting the driver outputs to a low impedance source can result in high driver currents. The thermal sensing circuitry detects the increase in die temperature under this condition and disables the driver outputs. The design of this circuitry ensures the disabling of driver outputs upon reaching a die temperature of 150°C. As the device cools, reenabling of the drivers occurs at a temperature of 140°C.

APPLICATIONS INFORMATION

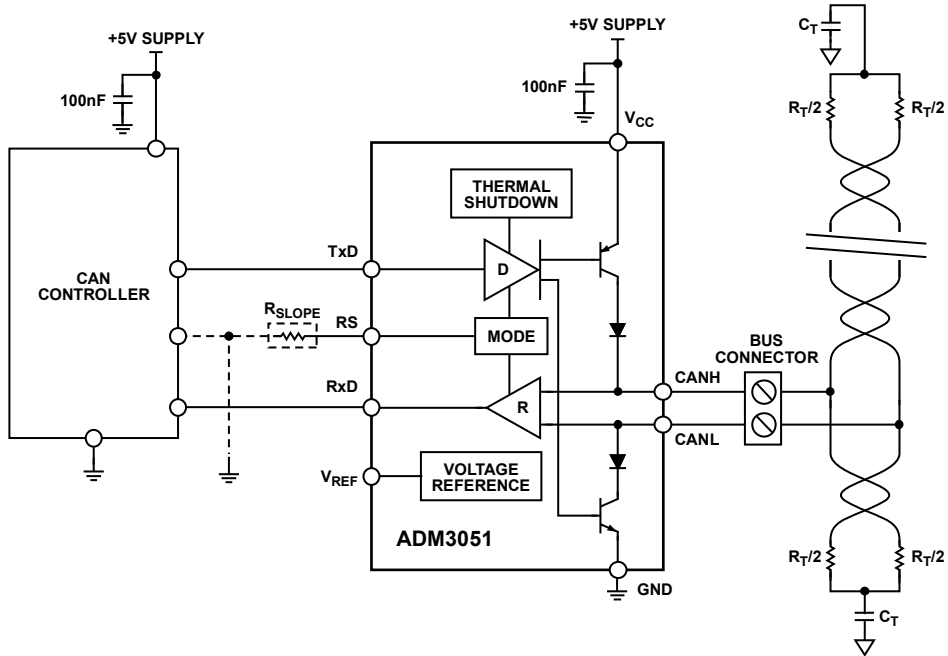

NOTES  
 1.  $R_T$  IS EQUAL TO THE CHARACTERISTIC IMPEDANCE OF THE CABLE USED.

Figure 30. Typical CAN Node Using the ADM3051

10029-028

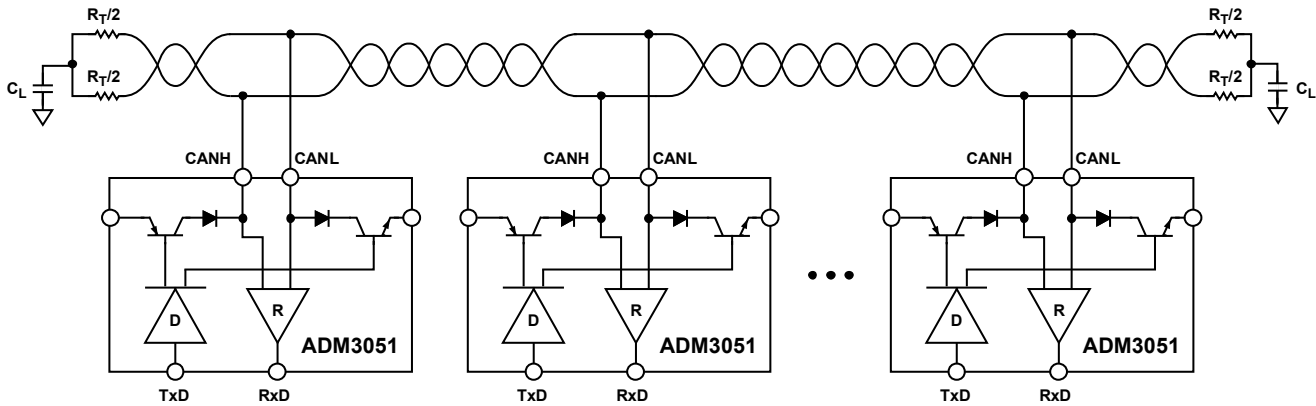

NOTES  
 1. MAXIMUM NUMBER OF NODES: 110.  
 2.  $R_T$  IS EQUAL TO THE CHARACTERISTIC IMPEDANCE OF THE CABLE USED.

Figure 31. Typical CAN Network

10029-029

### OUTLINE DIMENSIONS

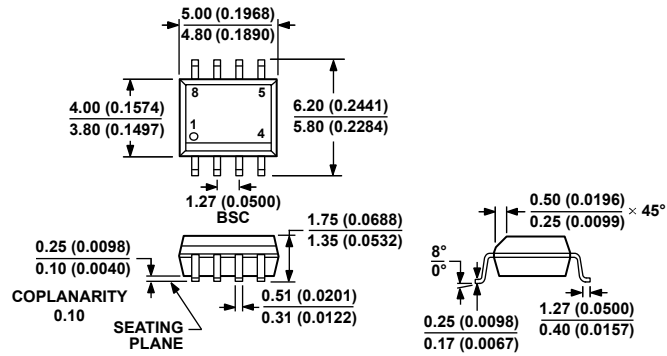

COMPLIANT TO JEDEC STANDARDS MS-012-AA  
 CONTROLLING DIMENSIONS ARE IN MILLIMETERS; INCH DIMENSIONS  
 (IN PARENTHESES) ARE ROUNDED-OFF MILLIMETER EQUIVALENTS FOR  
 REFERENCE ONLY AND ARE NOT APPROPRIATE FOR USE IN DESIGN.

Figure 32. 8-Lead Standard Small Outline Package [SOIC\_N]  
 Narrow Body  
 (R-8)

Dimensions shown in millimeters and (inches)

012A07-A

### ORDERING GUIDE

Model <sup>1</sup>	Temperature Range	Package Description	Package Option
ADM3051CRZ	-40°C to +125°C	8-Lead Standard Small Outline Package [SOIC_N]	R-8
ADM3051CRZ-REEL7	-40°C to +125°C	8-Lead Standard Small Outline Package [SOIC_N]	R-8
EVAL-ADM3051EBZ		Evaluation Board	

<sup>1</sup> Z = RoHS Compliant Part.



**NOTES**