

HIGH PERFORMANCE. POWERFUL TOOLBOX.



WaveSurfer 510 1 GHz Oscilloscope

Superior User Experience

Powerful, Deep Toolbox

Exceptional Serial Data Tools

Uncompromised Performance

The WaveSurfer 510 combines a **superior oscilloscope experience** with an **extensive toolbox** to deliver **faster time to insight.**



HIGH PERFORMANCE. POWERFUL TOOLBOX.

WaveSurfer 510

MAUI[®] with OneTouch



Deep Toolbox

Designed for Touch

Built for Simplicity

Made to Solve

OneTouch delivers a superior user experience by providing gesture control of common operations.

OBSESSED WITH TOOLS

WaveSurfer 510 has the greatest breadth and depth of tools, ensuring quick resolution of the most complicated debug tasks.

The WaveSurfer 510 combines a **superior oscilloscope experience** with an **extensive toolbox** to deliver **faster time to insight.**

1 Superior User Experience

2 Powerful, Deep Toolbox

3 Exceptional Serial Data Tools

4 Uncompromised Performance



Faster Time to Insight

Insight alone is not enough.

Markets and **technologies** change too rapidly.

The **timing** of **critical design decisions** is significant.

Time to insight is what matters.



MAUI – SUPERIOR USER EXPERIENCE



MAUI – Most Advanced User Interface was developed to put all the power and capabilities of the modern oscilloscope right at your fingertips. Designed for touch; all important oscilloscope controls are accessed through the intuitive touch screen. Built for simplicity; time saving shortcuts and intuitive dialogs simplify setup. Made to solve; a deep set of debug and analysis tools helps identify problems and find solutions quickly.

Designed for Touch

MAUI is designed for touch. Operate the oscilloscope just like a phone or tablet with the most unique touch screen features on any oscilloscope. All important controls are always one touch away. Touch the waveform to position or zoom in for more details using intuitive actions.

Built for Simplicity

MAUI is built for simplicity. Basic waveform viewing and measurement tools as well as advanced math and analysis capabilities are seamlessly integrated in a single user interface. Time saving shortcuts and intuitive dialogs simplify setup and shorten debug time.

Made to Solve

MAUI is made to solve. A deep set of integrated debug and analysis tools help identify problems and find solutions quickly. Unsurpassed integration provides critical flexibility when debugging. Solve problems fast with powerful analysis tools.

MAUI with OneTouch

MAUI with OneTouch introduces a new paradigm for oscilloscope user experience. Dramatically reduce setup time with revolutionary drag and drop actions to copy and setup channels, math functions, and measurement parameters without lifting a finger. Use common gestures like drag, drop, and flick to instinctively interact with the oscilloscope. Quickly enable a new channel, math or measurement using the “Add New” button and simply turn off any trace with a flick of the finger. These OneTouch innovations provide unsurpassed efficiency in oscilloscope operation.



- A** Channel, timebase, and trigger descriptors provide easy access to controls without navigating menus.
- B** Configure parameters by touching measurement results.
- C** Shortcuts to commonly used functions are displayed at the bottom of the channel, math and memory menus.
- D** Use the “Add New” button for one-touch trace creation.
- E** Drag to change source, copy setup, or turn on new trace.
- F** Drag to copy measurement parameters to streamline setup process.
- G** Drag to quickly position cursors on a trace.

POWERFUL, DEEP TOOLBOX

Capture		View			Measure	Math		Analyze											Document
Triggering	Acquire	Display Grids	Display Views	Zooming	Parameters	Parameter Analysis	Functions	Advanced Functions	Pass/Fail	Anomaly Detection	Serial Decode	Serial Message Analysis	Clock & Timing Jitter	Serial Data Jitter	Serial Data Analysis	Application Packages	Document		
1	2	3	4	5	6	7	8	9	10	11	12	13	14	15	16	17-22	23		
24	25	26	27	28	29	30	31	32	33	34	35	36	37	38	39	40-45	46		
47	48	49	50	51	52	53	54	55	56	57	58	59	60	61	62	63-67	68		
69	70	71	72	73	74	75	76	77	78	79	80	81	82	83	84	85-89	90		
91	92	93	94	95	96	97	98	99	100	101	102	103	104	105	106	107-114	115		
117	118	119	120	121	122	123	124	125	126	127	128	129	130	131	132	133	134		
140	141	142	143	144	145	146	147	148	149	150	151	152	153	154	155	156	157		

KEY

Element: 106 ▲ Invented by LeCroy ★ Unique to LeCroy

Category: Crosstalk Analysis MAUI Icon

Number: 106

Name: Crosstalk Analysis

Our Heritage

Teledyne LeCroy's 50+ year heritage has its origins in the high-speed collection of data in the field of high-energy physics, and the processing of long records to extract meaningful insight. We didn't invent the oscilloscope, but we did invent the digital oscilloscope, which can take full advantage of advanced digital signal processing and waveshape analysis tools to provide unparalleled insight.

Our Obsession

Our developers are true to our heritage – they are more obsessed with making better and smarter tools than anybody else. Our tools and operating philosophy are standardized across much of our product line for a consistent user experience. Our mission is to help you use these tools to understand problems, including the ones you don't even know you have. Our deep toolbox inspires insight; and your moment of insight is our reward.

Our Invitation

Our Periodic Table of Oscilloscope Tools provides a framework to understand the toolsets that Teledyne LeCroy has created and deployed in our oscilloscopes. Visit our interactive website to learn more about what we offer and how we can help you develop and debug more efficiently.

teledynelecroy.com/tools

WAVESURFER 510 AT A GLANCE

The WaveSurfer 510 combines the MAUI with OneTouch user interface with powerful waveform processing, in addition to advanced math, measurement, and debug tools, to quickly analyze and find the root cause of problems. The 12.1" touch-screen display of the WaveSurfer 510 is the largest in its class and makes viewing waveform abnormalities fast and easy.

Key Features

1 GHz, 10 GS/s, up to 16 Mpts/ch

MAUI with OneTouch

- Designed for touch
- Built for simplicity
- Made to solve

WaveScan - Advanced Search and Find

LabNotebook Documentation and Report Generation

History Mode - Waveform Playback

Sequence Mode Segmented Memory

Spectrum Analyzer Mode

Power Analysis Software

Serial Trigger and Decode

- I²C, SPI, UART
- CAN, LIN, FlexRay, SENT
- Ethernet 10/100BaseT, USB 1.0/1.1/2.0, USB2.0-HSIC
- Audio (I²S, LJ, RJ, TDM)
- MIL-STD-1553, ARINC 429
- MIPI D-PHY, DigRF 3G, DigRF v4
- Manchester, NRZ



Superior User Experience

The WaveSurfer 510 with MAUI OneTouch sets the standard for oscilloscope user experience by providing the most unique touch features on any oscilloscope. Common gestures are used to instinctively interact with the oscilloscope and dramatically reduce setup time. Convenience and efficiency are optimized - all common operations can be performed with one touch and do not require opening and closing of pop-up dialogs or menus.

Uncompromised Performance

Many 1 GHz oscilloscopes are available at attractive entry-point prices, however, they are often limited in sample rate, memory or features. The WaveSurfer 510 provides uncompromised 1 GHz performance with up to 10 GS/s per channel and 32 Mpts of memory.

Advanced Debug Tools

Advanced debug tools make the WaveSurfer 510 an unparalleled debug and analysis machine providing 10 GS/s sample rate on 4 channels, 32 Mpts of memory, sequence mode, history mode, advanced math functions, and 2 simultaneous math traces.

Capture Debug, Analyze, Document

Easily accessible measurement, math and debug tools, plus a wide variety of serial data protocol decoders, and active probes ensure the WaveSurfer 510 can capture and analyze any type of waveform and simplify the debug process. The LabNotebook tool provides a fast way to save waveforms, save setups and screen images, report results, and view offline.



Key Attributes

- 1 12.1" Widescreen (16x9) high resolution WXGA color touch screen display
- 2 MAUI with OneTouch optimized for convenience and efficiency
- 3 "Add New" button for fast waveform creation
- 4 "Push" Knobs – All knobs have push functionality that provide shortcuts to common actions such as Set to Variable, Find Trigger Level, Zero Offset, and Zero Delay
- 5 Waveform Control Knobs – Control channel, zoom, math and memory traces with the multiplexed vertical and horizontal knobs
- 6 Dedicated Cursor Knob – Select type of cursor, position them on your signal, and read values without ever opening a menu
- 7 Dedicated buttons to quickly access popular debug tools.
- 8 L-Bus connectivity allow for the addition of the MS-250 or MS-500 mixed signal options.
- 9 Easy connectivity with four USB 3.1 ports and three USB 2.0 ports



ADVANCED TOOLS FOR WAVEFORM ANALYSIS



Embedded Controller Design and Debug

Save time when working with embedded controllers by adding high-performance mixed signal capability with the WaveSurfer 510. Capture digital signals up to 250 MHz with up to 10 Mpts/Ch memory, 1 GS/s and 18 channels. Quickly and easily isolate specific serial data events with I²C, SPI, UART, RS-232, USB 1.0/1.1/2.0, USB2-HSIC, 10/100Base T ENET, Audio (I²S, LJ, RJ, TDM), MIL-STD-1553, ARINC 429, MIPI D-PHY, DigRF, CAN, CAN FD, LIN, FlexRay, SENT, Manchester, and NRZ trigger and decode options.



WaveScan Advanced Search and Find Tool

Quickly search waveforms for runs, glitches or other anomalies with WaveScan.

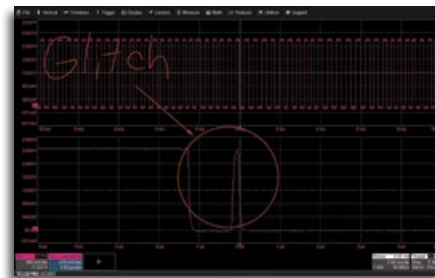

LabNotebook Documentation and Report Generation Tool

Save all results and data with a single button press and create custom reports with LabNotebook.



Pass/Fail Mask Testing

Built-in masking testing quickly identifies problems and marks the location. A history of the pass/fail results can be displayed on the screen.

Enhanced Resolution

The enhanced resolution (ERES) feature improves vertical resolution of the oscilloscope resulting in cleaner traces and the ability to see more signal details. Up to 3 bits of ERES can be applied.

Advanced Math and Measure

Use automatic measurement parameters with statistics and histograms as well as math functions to understand every waveform detail.

WaveStream Fast Viewing Mode

WaveStream provides a vibrant, intensity graded (256 levels) display with a fast update to closely simulate the look and feel of an analog oscilloscope.

LabNotebook Documentation Tool

LabNotebook is a one-button tool to save and restore waveforms, measurements and settings without navigating multiple menus. Custom reports can be created and easily shared; saved waveforms can be measured and analyzed later both on the oscilloscope or offline using the WaveStudio PC Utility.

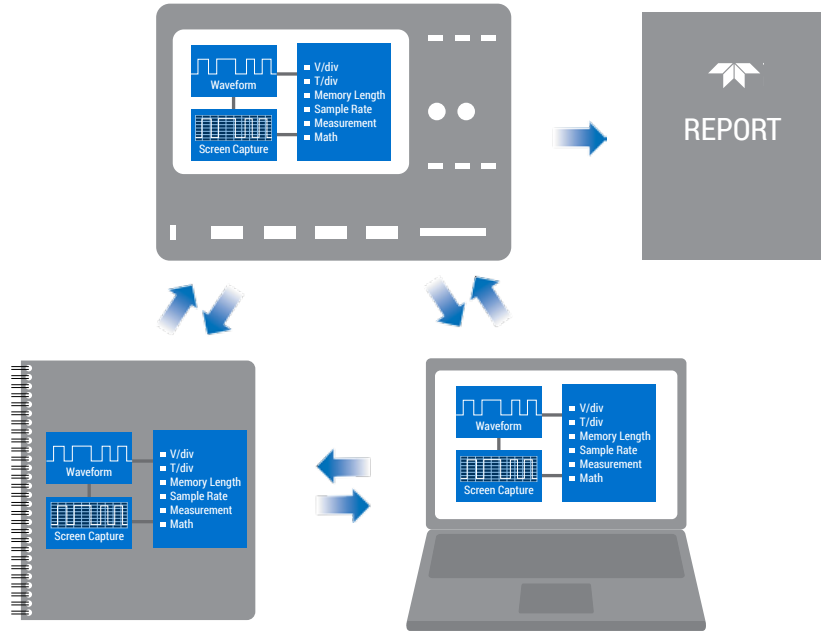

WaveStudio Offline Analysis Tool

WaveStudio is a fast and easy way to analyze acquired waveforms offline. Offline tools include x and y axis cursors for quick measurements and 21 built-in automatic measurements for more precise and accurate results. WaveStudio can also connect to the oscilloscope for direct data transfer to the PC. Data saved with LabNotebook can be shared with others using WaveStudio for easy collaboration.

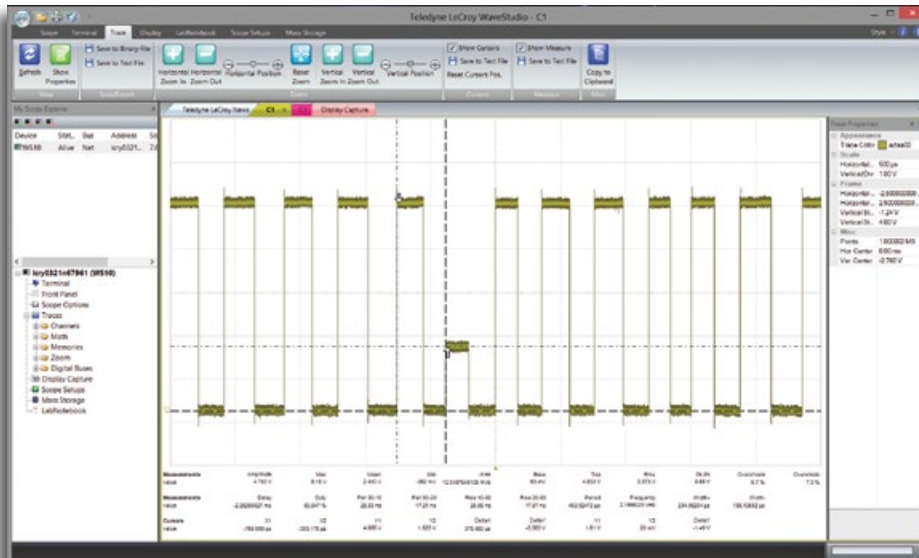

Advanced Probe Interface

The advanced active probe interface gives tremendous flexibility for measuring high voltages, high frequencies, currents, or differential signals.

High Impedance Active Probes



High Bandwidth Differential Probes



High Voltage Differential Probes



High Voltage Passive Probes



Current Probes



ADVANCED DEBUG TOOLS

The WaveSurfer 510 includes the advanced debug tools which makes it an unparalleled debug and analysis machine. The high sample rate of 10 GS/s on all 4 channels, 32 Mpts of memory, sequence mode segmented memory, history mode waveform playback, 13 additional math functions, and 2 simultaneous math traces, all included in this powerful debug package, enable the WaveSurfer 510 to perform advanced analysis on long captures with 10x oversampling to find the root cause of problems.



A With 10 GS/s and 16 Mpts per channel every detail of a signal will be captured and displayed. In 4 channel operation 1.6ms of data can be captured at full sample rate, in 2 channel mode, 3.2ms, to ensure no detail or anomaly is missed.

B Configure and view 2 simultaneous math traces, each math trace can perform dual math operation enabling complex analysis and faster troubleshooting.

C Advanced math and measurements capabilities allow deeper analysis. Included functions are absolute value, average (summed or continuous), derivative, difference, envelope, enhanced resolution, exp (base e), exp (base 10), FFT, floor, integral, invert, log (base e), log (base 10), product, ratio, reciprocal, rescale, roof, square, square root, sum, trend and zoom.

D Display up to 6 measurement parameters together with statistics, including mean, minimum, maximum, standard deviation, and total number. Each occurrence of each parameter is measured and added to the statistics table. Histograms provide a fast, dynamic view of parameters and wavelshape characteristics. Parameter gates define the location for measurement on the source waveform.

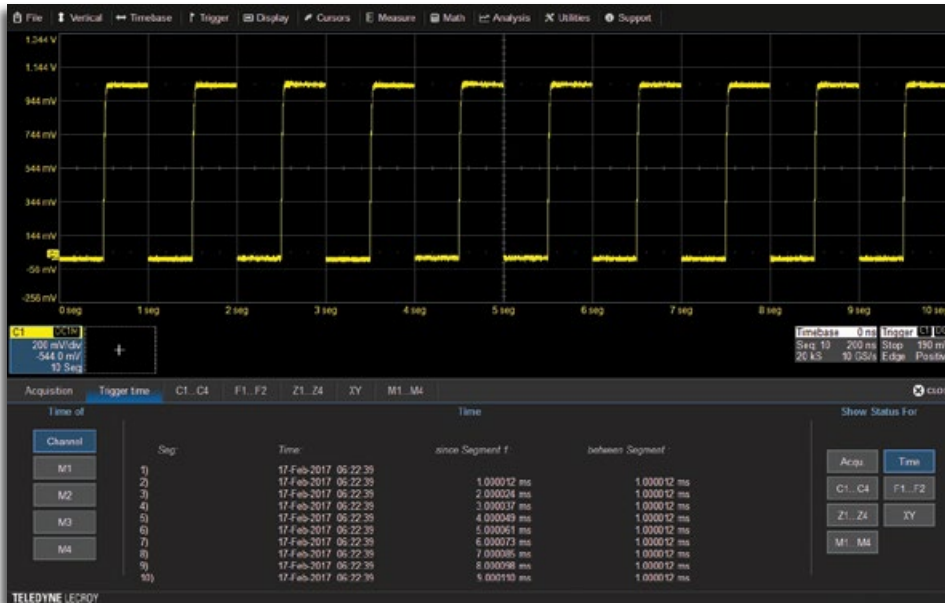

Advanced Waveform Capture with Sequence Mode

Use Sequence mode to store up to 5,000 triggered events as “segments” into memory. This can be ideal when capturing many fast pulses in quick succession or when capturing events separated by long time periods. Sequence mode provides timestamps for each acquisition and minimizes dead-time between triggers to less than 1 μ s. Combine Sequence mode with advanced triggers to isolate rare events over time and analyze afterwards.

History Mode Waveform Playback

Scroll back in time using History Mode to view previous waveforms and isolate anomalies. Use cursors and measurement parameters to quickly find the source of problems. History mode is always available with a single button press, no need to enable this mode and never miss a waveform.

Go Back in Time to Identify the Source of a Problem

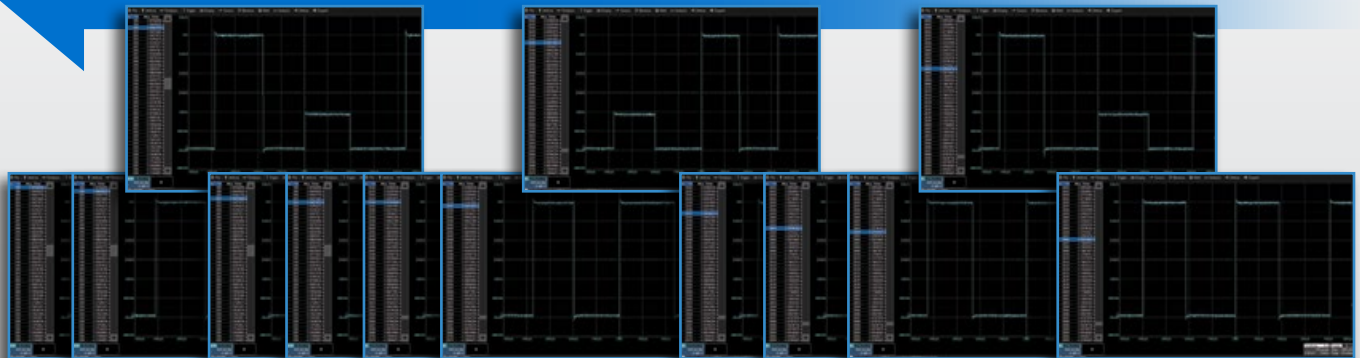

SERIAL TRIGGER AND DECODE OPTIONS

The HDO4000A features the widest range and most complete serial data debug and validation solutions.

- Triggering
- Decoding

WaveSurfer 510 Serial Data Protocol Support

		Trigger	Decode
Embedded Computing	I ² C	•	•
	SPI	•	•
	UART-RS232	•	•
	USB2-HSIC		•
Automotive + Industrial	CAN	•	•
	CAN FD	•	•
	FlexRay	•	•
	LIN	•	•
	SENT		•
Avionics	ARINC429		•
	MIL-STD-1553	•	•
	SPACEWIRE		•
Computing + Peripherals	Ethernet (10/100Base-T)		•
	MDIO		•
	USB 1.1/2.0	•	•
	8b/10b	•	•
	D-PHY/CSI-2/DSI		•
MIPI	DigRF3G		•
	DigRFv4		•
	SPMI		•
Other	Audio (I ² S, LJ, RJ, TDM)	•	•
	Manchester		•
	NRZ	•	•

T D

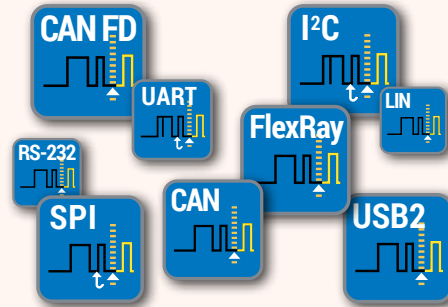

Trigger

Powerful, flexible triggers designed by people who know the standards, with the unique capabilities you want to isolate unusual events. Conditional data triggering permits maximum flexibility and highly adaptable error frame triggering is available to isolate error conditions. Efficiently acquire bursted data using Sequence Mode to maximize the oscilloscope's memory usage. Sequence Mode enables the oscilloscope to ignore idle time and acquire only data of interest.

Decode

Decoded protocol information is color-coded to specific portions of the serial data waveform and transparently overlaid for an intuitive, easy-to-understand visual record. All decoded protocols are displayed in a single time-interleaved table. Touch a row in the interactive table to quickly zoom to a packet of interest and select a column header to create filter criteria, as is commonly done in spreadsheets. Easily search through long records for specific protocol events using the built-in search feature.

Teledyne LeCroy's versatile WaveSurfer 510 mixed signal oscilloscope combines the powerful WaveSurfer 510 with the flexibility of digital inputs using the MS-250. In addition, the many triggering and decoding options turn the WaveSurfer 510 into an all-in-one analog, digital, and serial data trigger, acquisition, and debug machine.

High-performance Mixed Signal Capabilities

Embedded controller design and debug involves capturing and viewing a number of different types of signals. These signals are typically a mix of analog, digital, and serial data waveforms from a combination of analog sensors, microcontrollers and peripheral devices. With the ability to capture digital signals with speeds up to 250 MHz and long memory of 10 Mpts/Ch the WaveSurfer 510 provides unmatched mixed signal performance. The WaveSurfer 510 is the ideal tool for testing embedded systems with 8-bit microcontrollers or slower digital signals. With 18 digital inputs each with 250 MHz maximum input frequency and 10 Mpts/Ch memory, the WaveSurfer 510 is an outstanding value and provides a complete set of tools for embedded system testing.

Extensive Triggering

The WaveSurfer 510 has extensive digital trigger capabilities. Normal oscilloscope triggers will operate on digital inputs. Cross-pattern triggering allows for simple or complex trigger patterns to be setup with any combination of analog and digital channels. Event triggering can be configured to arm on an analog signal and trigger on a digital pattern.

Quick Mixed Signal Setup, Easy-to-use

Unlike a traditional Logic Analyzer, the WaveSurfer 510 is easy to use. A simple connection links the oscilloscope with the digital inputs so users can start viewing signals and begin debugging quickly. In addition, all standard oscilloscope tools are readily accessible. Signal debug is simple, using standard oscilloscope tools, such as cursors, measurement parameters, and zooming.



SPECTRUM AND POWER ANALYZER

Simple Frequency Domain Analysis

Get better insight to the frequency content of any signal with use of the Spectrum Analyzer mode on the WaveSurfer 510. This mode provides a spectrum analyzer style user interface with controls for start/stop frequency or center frequency and span. The unique peak search automatically labels spectral components and presents frequency and level in an interactive table. Utilize up to 20 markers to automatically identify harmonics and monitor how the spectrum changes over time using the spectrogram which can display a 2D or 3D history of the frequency content.

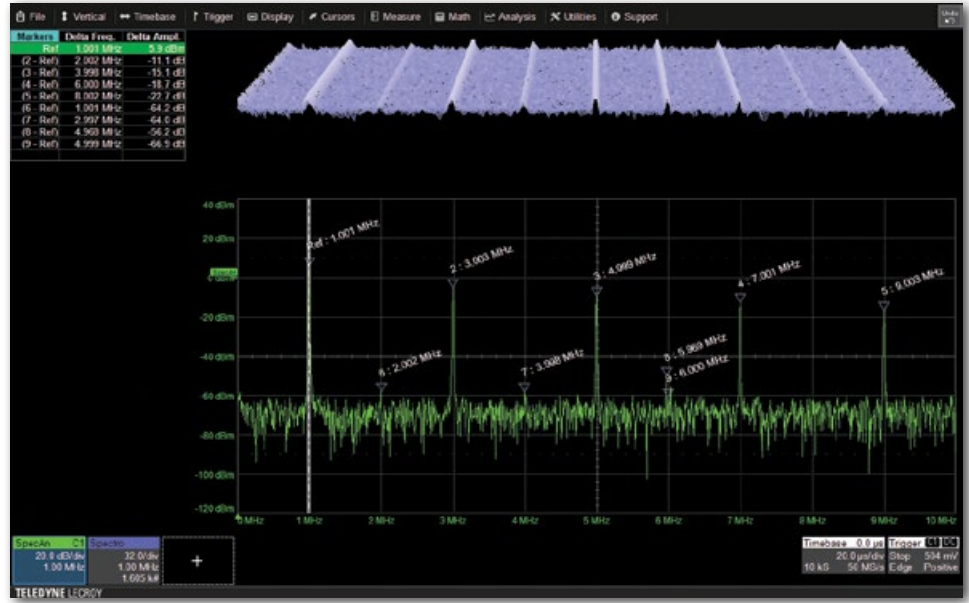

Power Analyzer Automates Switching Device Loss Measurements

Quickly measure and analyze the operating characteristics of power conversion devices and circuits with the Power Analyzer option. Critical power switching device measurements, control loop modulation analysis, and line power harmonic testing are all simplified with a dedicated user interface and automatic measurements. Areas of turn-on, turn-off, and conduction loss are all identified with color-coded waveform overlays for faster analysis. Power Analyzer provides quick and easy setup of voltage and current inputs and makes measurements as simple as the push of a button. Tools are provided to help reduce sources of measurement



errors and the measurement parameters provide details of single cycle or average device power losses. Beyond the advanced power loss measurement capabilities, the Power Analyzer modulation analysis capabilities provide insight to

understand control loop response to critical events such as a power supply's soft start performance or step response to line and load changes. The Line Power Analysis tool allows simple and quick pre-compliance testing to EN 61000-3-2.

SPECIFICATIONS

WaveSurfer 510

Vertical System

Analog Bandwidth @ 50 Ω (-3 dB)	1 GHz (≥ 2 mV/div)
Analog Bandwidth @ 1 M Ω (-3 dB)	500 MHz (typical)
Rise Time (10–90%, 50 Ω)	415 ps (typical)
Input Channels	4
Vertical Resolution	8-bits; up to 11-bits with enhanced resolution (ERES)
Sensitivity	50 Ω : 1 mV/div–1 V/div, fully variable; 1 MΩ : 1 mV/div–10 V/div, fully variable
DC Vertical Gain Accuracy (Gain Component of DC Accuracy)	$\pm 1\%$ F.S. (typical), offset at 0 V
Channel-Channel Isolation	DC up to rated BW: 40 dB ($>100:1$), (For any two ProBus input channels, same v/div settings, typical)
Offset Range	50 Ω : ± 1.6 V @ 1 mV–4.95 mV/div, ± 4 V @ 5 mV–9.9 mV/div, ± 8 V @ 10 mV–19.8 mV/div, ± 10 V @ 20 mV–1 V/div 1 MΩ : ± 1.6 V @ 1 mV–4.95 mV/div, ± 4 V @ 5 mV–9.9 mV/div, ± 8 V @ 10 mV–19.8 mV/div, ± 16 V @ 20 mV–100 mV/div, ± 80 V @ 102 mV–1.0 V/div, ± 160 V @ 1.02 V–10 V/div
DC Vertical Offset Accuracy	$\pm(1.5\%$ of offset setting $+1\%$ of full scale $+ 1$ mV) (test limit)
Maximum Input Voltage	50 Ω : 5 V _{rms} ± 10 V peak; 1 MΩ : 400 V max. (DC + peak AC < 10 kHz)
Input Coupling	1 MΩ : AC, DC, GND; 50 Ω : DC, GND
Input Impedance	50 Ω $\pm 2\%$ or 1 M Ω 17pF, 10 M Ω 9.5 pF with supplied Probe
Bandwidth Limiters	20 MHz, 200 MHz

Horizontal System

Timebases	Internal timebase common to 4 input channels; an external clock may be applied at the EXT input
Acquisition Modes	Real-time, Roll, Random Interleaved Sampling (RIS), Sequence
Time/Division Range	200 ps/div - 1000 s/div RIS available at ≤ 10 ns/div; Roll Mode available at ≥ 100 ms/div and ≤ 5 MS/s
Clock Accuracy	≤ 1.5 ppm +(aging of 0.5 ppm/yr from last calibration)
Sample Clock Jitter	Up to 10 μ s Acquired Time Range: 100fsrms (Internal Timebase Reference) Up to 10ms Acquired Time Range: 360fsrms (Internal Timebase Reference)
Delta Time Measurement Accuracy	$\sqrt{2} * \sqrt{\left(\frac{\text{Noise}}{\text{SlewRate}}\right)^2 + (\text{Sample Clock Jitter})^2 \text{ (RMS)} + (\text{clock accuracy} * \text{reading}) \text{ (seconds)}}$
Jitter Measurement Floor	$\sqrt{\left(\frac{\text{Noise}}{\text{SlewRate}}\right)^2 + (\text{Sample Clock Jitter})^2 \text{ (RMS, seconds, TIE)}}$
Channel-Channel Deskew Range	± 9 x time/div. setting, 100 ms max., each channel

Acquisition System

Sample Rate (Single-Shot)	10 GS/s on 4 Ch
Sample Rate (Repetitive)	50 GS/s for repetitive signals (20 ps/div to 10 ns/div)
Memory Length (# of Segments in Sequence Mode)	16 Mpts/ch for all channels, 32 Mpts (interleaved) (5,000 segments)
Intersegment Time	1 μ s
Averaging	Summed averaging to 1 million sweeps; continuous averaging to 1 million sweeps
Enhanced Resolution (ERES)	From 8.5 to 11 bits vertical resolution
Envelope (Extrema)	Envelope, floor, or roof for up to 1 million sweeps
Interpolation	Linear or Sin x/x

SPECIFICATIONS

WaveSurfer 510

Triggering System

Modes	Normal, Auto, Single, and Stop
Sources	Any input channel, Ext, Ext/10, or line; slope and level unique to each source (except line trigger)
Coupling Mode	DC, AC, HFRej, LFRaj
Pre-trigger Delay	0 - 100% of memory size (adjustable in 1% increments or 100 ns)
Post-trigger Delay	0 - 10,000 divisions in real time mode, limited at slower time/div settings or in roll mode
Hold-off	From 2 ns up to 20 s or from 1 to 99,999,999 events
Trigger and Interpolator Jitter	≤ 3.5 ps RMS (typical)
Internal Trigger Level Range	±4.1 div from center (typical)
External Trigger Level Range	Ext (±0.4 V); Ext/10 (±4 V)
Maximum Trigger Rate	1,000,000 waveforms/second (in Sequence Mode, up to 4 channels)
Trigger Sensitivity with Edge Trigger (Ch 1-4)	2 div @ < 1 GHz 1.5 div @ < 500 MHz 1 div @ < 200 MHz 0.9 div @ < 10 MHz (DC, AC, and LFRaj coupling, ≥ 10 mV/div, 50 Ω)
Trigger Sensitivity with Edge Trigger (External Input)	2 div @ < 1 GHz 1.5 div @ < 500 MHz 1 div @ < 200 MHz 0.9 div @ < 10 MHz (DC, AC, and LFRaj coupling)
Max. Trigger Frequency, SMART Trigger	1.0 GHz @ ≥ 10 mV/div (minimum triggerable width 750 ps)

Basic Triggers

Edge	Triggers when signal meets slope (positive, negative, or either) and level condition
Width	Triggers on positive or negative glitches with selectable widths.
Glitch	Triggers on positive or negative glitches with selectable widths. Minimum width 200 ps, maximum width: 20 s
Window	Triggers when signal exits a window defined by adjustable thresholds
Pattern	Logic combination (AND, NAND, OR, NOR) of 5 inputs (4 channels and external trigger input). Each source can be high, low, or don't care. The High and Low level can be selected independently. Triggers at start or end of the pattern.
TV-Composite Video	Triggers NTSC or PAL with selectable line and field; HDTV (720p, 1080i, 1080p) with selectable frame rate (50 or 60 Hz) and Line; or CUSTOM with selectable Fields (1-8), Lines (up to 2000), Frame Rates (25, 30, 50, or 60 Hz), Interlacing (1:1, 2:1, 4:1, 8:1), or Synch Pulse Slope (Positive or Negative)
Runt	Trigger on positive or negative runts defined by two voltage limits and two time limits. Select between 1 ns and 20 ns.
Slew Rate	Trigger on edge rates. Select limits for dV, dt, and slope. Select edge limits between 1 ns and 20 ns.
Interval	Triggers on intervals selectable between 1 ns and 20 s.
Dropout	Triggers if signal drops out for longer than selected time between 1 ns and 20 s.
Triggers with Exclusion Technology Qualified (Timeout or State/Edge Qualified)	Trigger on intermittent faults by specifying the expected behavior and triggering when that condition is not met
Low Speed Serial Protocol Trigger (Optional)	I2C, SPI (SPI, SSPI, SIOP), UART-RS232, CAN1.1, CAN2.0, CAN FD, LIN, FlexRay, MIL-STD-1553, AudioBus (I2S, LJ, RJ, TDM), USB1.x/2.0, SATA

Measurement Tools

Measurement Functionality	Display up to 6 measurement parameters together with statistics, including mean, minimum, maximum, standard deviation, and total number. Each occurrence of each parameter is measured and added to the statistics table. Parameter gates define the location for measurement on the source waveform.
Measurement Parameters - Horizontal + Jitter	Delay (from trigger, 50%), Duty Cycle, Edges, Fall Time (90-10, 80-20), Frequency, Period, Δ Period, Phase, Rise Time (10-90, 20-80), Skew, Width+, Width-
Measurement Parameters - Vertical	Amplitude, Base, Maximum, Mean, Minimum, Peak-to-Peak, RMS, Std. Deviation, Top.
Measurement Parameters - Pulse	Area, Base, Fall Time (90-10, 80-20), Overshoot (positive, negative), Rise Time (10-90, 80-20), Top, Width+, Width-

Math Tools

Math Functionality	Display up to 2 math functions traces (F1-F2). The easy-to-use graphical interface simplifies setup of up to two operations on each function trace, and function traces can be chained together to perform math-on-math.
Math Operators - Basic Math	Average (summed), Average (continuous), Difference (-), Envelope, Exp (base e, base 10), Floor, Invert (negate), Log (base e, base 10), Product (x), Ratio (/), Reciprocal, Rescale (with units), Roof, Sum (+).
Holdoff	Holdoff between A and B, B and C, C and D is selectable by time (1ns to 20s) or number of events. Measurement trigger selection as the last stage in a Cascade precludes a holdoff setting between the prior stage and the last stage.
Math Operators - Filters	Enhanced resolution (to 11 bits vertical)
Math Operators - Frequency Analysis	FFT (power spectrum, magnitude), up to full record length. Select from Rectangular, VonHann, Hamming, FlatTop and Blackman Harris windows.
Math Operators - Functions	Absolute value, Derivative, Integral, Invert (negate), Reciprocal, Rescale (with units), Square, Square root, Zoom (identity).

Measurement and Math Integration

Trend (datalog) of up to 1 million measurement parameters

SPECIFICATIONS

WaveSurfer 510

Pass/Fail Testing

Mask Test (pre-defined or user-defined mask, waveform All In, All Out, Any In, or Any Out conditions) with following THEN Save (waveforms), Stop, Alarm, (send) Pulse, Hardcopy (send email, save screen image, save to clipboard, send to printer), or (save) LabNotebook.

Display System

Display Size	Color 12.1" widescreen flat panel TFT-Active Matrix with high resolution touch screen
Display Resolution	WXGA; 1280 x 800 pixels
Number of Traces	Display a maximum of 16 traces. Simultaneously display channel, zoom, memory and math traces.
Grid Styles	Auto, Single,X-Y, Single+X-Y
Waveform Representation	Sample dots joined, or sample dots only

Processor/CPU

Type	Intel® Core™ i3-6100 Dual, 3.7 GHz (or better)
Processor Memory	8 GB standard
Operating System	Microsoft Windows® 7 For Embedded Systems 64Bits
Oscilloscope Operating Software	Teledyne LeCroy MAUI™
Real Time Clock	Date and time displayed with waveform in hardcopy files. SNTP support to synchronize to precision internal clocks

Connectivity

Ethernet Port	Supports 2 10/100/1000BaseT Ethernet interface (RJ45 ports)
USB	4 side USB 3.1 Gen1 ports, and 1 front USB 3.1 port support Windows compatible devices
GPIB Port (optional)	Supports IEEE – 488.2 (External)
External Monitor Port	DisplayPort 1.1 and HDMI to support customer-supplied external monitor. Includes support for extended desktop operation with UHD (3840 x 2160) pixel resolution and split-grid capability on external monitor. Supports touch screen integration of external monitor (Note: external display can not use a Fujitsu touch-screen driver).
Remote Control	Via Windows Automation, or via Teledyne LeCroy Remote Command Set
Network Communication Standard	VXI-11 or VICP, LXI Class C (v1.2) Compliant

Probes

Standard Probes	Qty. (4) ±10 Passive Probes
Probing System	ProBus. Automatically detects and supports a variety of compatible probes

Power Requirements

Voltage	100-240 VAC ±10% at 50/60 Hz ±5%; 110-120 VAC ±10% at 400 Hz ±5%; Automatic AC Voltage Selection
Power Consumption (Nominal)	285 W / 285 VA
Max Power Consumption	375 W / 375 VA (with all PC peripherals and active probes connected to 4 channels)

Environmental

Temperature (Operating)	+5 °C to +40 °C
Temperature (Non-Operating)	-20 °C to +60 °C
Humidity (Operating)	5% to 90% relative humidity (non-condensing) up to +31 °C. Upper limit derates to 50% relative humidity (non-condensing) at +40 °C.
Humidity (Non-Operating)	5% to 95% relative humidity (non-condensing) as tested per MIL-PRF-28800F
Altitude (Operating)	Up to 10,000 ft. (3048 m) at or below +30 °C
Altitude (Non-Operating)	Up to 40,000 ft. (12,192 m)
Random Vibration (Operating)	0.31 grms 5 Hz to 500 Hz, 15 minutes in each of three orthogonal axes
Random Vibration (Non-Operating)	2.4 grms 5 Hz to 500 Hz, 15 minutes in each of three orthogonal axes
Functional Shock	30 g peak, half sine, 11 ms pulse, 3 shocks (positive and negative) in each of three orthogonal axes, 18 shocks total

Physical Dimensions

Dimensions (HWD)	12.44"H x 16.42"W x 9.37"D (316 x 417 x 238 mm)
Weight	22.8 lbs. (10.3 kg)

Certifications

CE Compliant, UL and cUL listed; conforms to UL 61010-1 (3rd Edition), UL 61010-2-030 (1st Edition) CAN/CSA C22.2 No. 61010-1-12

Warranty and Service

3-year warranty; calibration recommended annually. Optional service programs include extended warranty, upgrades, and calibration services.

ORDERING INFORMATION

Product Description

WaveSurfer 510 Oscilloscopes

1 GHz, 10 GS/s, 4 Ch, 16 Mpts/Ch DSO with 12.1" Touch Screen Display, 10 GS/s, 32 Mpts Interleaved	WaveSurfer 510
--	----------------

Included with Standard Configurations

±10 Passive Probe (Total of 1 Per Channel), Protective Front Cover, Getting Started Guide, Commercial NIST Traceable Calibration with Certificate, Power Cable for the Destination Country, 3-year Warranty

General Accessories

External GPIB Accessory	USB2-GPIB
Instrument Cart	OC1021-A
Hard Carrying Case	WS510-HARDCASE
Rack Mount Accessory	WS510-RACK

Local Language Overlays

German Front Panel Overlay	WS510-FP-GERMAN
French Front Panel Overlay	WS510-FP-FRENCH
Italian Front Panel Overlay	WS510-FP-ITALIAN
Spanish Front Panel Overlay	WS510-FP-SPANISH
Japanese Front Panel Overlay	WS510-FP-JAPANESE
Korean Front Panel Overlay	WS510-FP-KOREAN
Chinese (Tr) Front Panel Overlay	WS510-FP-CHNES-TR
Chinese (Simp) Front Panel Overlay	WS510-FP-CHNES-SI
Russian Front Panel Overlay	WS510-FP-RUSSIAN

Mixed Signal Solutions

500 MHz, 18 Channels, 2 GS/s, 50 Mpts/ch Mixed Signal Oscilloscope Option	MS-500
250 MHz, 36 Ch, 1 GS/s, 25 Mpts/ch (500 MHz, 18 Ch, 2 GS/s, 50 Mpts/ch Interleaved) Mixed Signal Option	MS-500-36
250 MHz, 18 Channels, 1 GS/s, 10 Mpts/ch Mixed Signal Oscilloscope Option	MS-250

Mixed Signal Accessories

Extra Large Gripper Probe Set, Includes 22 probes	PK400-0
Large Gripper Probe Set for 0.10 Inch (2.54 mm) Pin Pitch. Includes 10 Probes with Color-coded Leads	PK400-1
Medium Gripper Probe Set for 0.04 Inch (1.0 mm) Pin Pitch. Includes 10 Probes with Color-coded Leads	PK400-2
Small Gripper Probe Set for 0.008 Inch (0.2 mm) Pin Pitch. Includes 10 Probes with Color-coded Leads	PK400-3
18-pin 3M Interface Cable MSO-3M (Mates with 3M Part Number 2520-6002)	MSO-3M
36 Channel Mictor Connector (Includes 1 MSO-MICTOR-SHROUD)	MSO-Mictor
16" Digital Lead Set, D0-D17	MSO-DLS-18
16" Digital Lead Set, D18-D35	MSO-DLS-36

Product Code

Product Description

Serial Data Options

ARINC 429 Symbolic Decode Option	WS510-ARINC429bus DSymbolic
Audiobus Trigger and Decode Option for I ² S, LJ, RJ, and TDM	WS510-Audiobus TD
CAN Trigger and Decode Option	WS510-CANbus TD
CAN FD Trigger and Decode Option	WS510-CAN FDbus TD
D-PHY Decode Option	WS510-DPHYbus D
DigRF 3G Decode Option	WS510-DigRF3Gbus D
DigRF v4 Decode Option	WS510-DigRFv4bus D
ENET Decode Option	WS510-ENETbus D
FlexRay Trigger and Decode Option	WS510-FlexRaybus TD
I ² C, SPI and UART Trigger and Decode Option	WS510-EMB
I ² C Bus Trigger and Decode Option	WS510-I2Cbus TD
LIN Trigger and Decode Option	WS510-LINbus TD
Manchester Decode Option	WS510-Manchesterbus D
MDIO Decode Option	WS510-MDIObus D
MIL-STD-1553 Trigger and Decode Option	WS510-1553 TD
NRZ Decode Option	WS510-NRZbus D
SENT Decode Option	WS510-SENTbus D
SpaceWire Decode Option	WS510-SENTbus D
SPI Bus Trigger and Decode Option	WS510-SPIbus TD
SPMI Decode Option	WS510-SPMIbus D
UART and RS-232 Trigger and Decode Option	WS510-UART-RS232bus TD
USB 2.0 Decode Option	WS510-USB2bus D
USB2-HSIC Decode Option	WS510-USB2-HSICbus D

Probes

500 MHz Passive Probe, 2.5mm, 10:1, 10 M Ω	PP008
500 MHz Passive Probe 10:1, 10 M Ω	PP011
500 MHz Passive Probe, 2.5mm, 10:1, 10 M Ω	PP021
500 MHz Passive Probe, 5mm, 10:1, 10 M Ω	PP025
700 V, 15 MHz High-Voltage Differential Probe	AP031
200 MHz, 3.5 pF, 1 M Ω Active Differential Probe	ZD200
500 MHz, 1.0 pF Active Differential Probe, ±8 V	ZD500
1 GHz, 1.0 pF, 1 M Ω Active Differential Probe	ZD1000
1.5 GHz, 1.0 pF Active Differential Probe, ±8 V	ZD1500
Deskew Calibration Source for CP031 and CP030	DCS015
30 A; 50 MHz Current Probe – AC/DC; 30 A _{rms} ; 50 A _{peak} Pulse	CP030
30 A; 50 MHz High Sensitivity Current Probe – AC/DC; 30 A _{rms} ; 50 A _{peak} Pulse	CP030A
30 A; 100 MHz Current Probe – AC/DC; 30 A _{rms} ; 50 A _{peak} Pulse	CP031
30 A; 100 MHz High Sensitivity Current Probe – AC/DC; 30 A _{rms} ; 50 A _{peak} Pulse	CP031A
150 A; 10 MHz Current Probe – AC/DC; 150 A _{rms} ; 500 A _{peak} Pulse	CP150
500 A; 2 MHz Current Probe – AC/DC; 500 A _{rms} ; 700 A _{peak} Pulse	CP500
1,400 V, 100 MHz High-Voltage Differential Probe	ADP305
1,400 V, 20 MHz High-Voltage Differential Probe	ADP300
1 Ch, 100 MHz Differential Amplifier with Precision Voltage Source	DA1855A
1.5 GHz, 0.9 pF, 1 M Ω High Impedance Active Probe	ZS1500
Set of 4 ZS1500, 1.5 GHz, 0.9 pF, 1 M Ω High Impedance Active Probe	ZS1500-QUADPAK
1 GHz, 0.9 pF, 1 M Ω High Impedance Active Probe	ZS1000
Set of 4 ZS1000, 1 GHz, 0.9 pF, 1 M Ω High Impedance Active Probe	ZS1000-QUADPAK

Product Description**Product Code****Probes (cont'd)**

25 MHz High Voltage Differential Probe	HVD3102
1kV, 25 MHz High Voltage Differential Probe without tip Accessories	HVD3102-NOACC
80 MHz High Voltage Differential Probe with 6m cable	HVD3106-6M
120 MHz High Voltage Differential Probe	HVD3106
1kV, 120 MHz High Voltage Differential Probe without tip Accessories	HVD3106-NOACC
2kV, 120 MHz High Voltage Differential Probe	HVD3206
2kV, 80 MHz High Voltage Differential Probe with 6m cable	HVD3206-6M
6kV, 100 MHz High Voltage Differential Probe	HVD3605
100:1 400 MHz 50 M Ω 1 kV High-voltage Probe	HVP120
100:1 400 MHz 50 M Ω 4 kV High-voltage Probe	PPE4KV
1000:1 400 MHz 50 M Ω 5 kV High-voltage Probe	PPE5KV
1000:1 400 MHz 50 M Ω 6 kV High-voltage Probe	PPE6KV
TekProbe to ProBus Probe Adapter	TPA10
Set of 4 TPA10 TekProbe to ProBus Probe Adapters. Includes soft carrying case.	TPA10-QUADPAK

Customer Service

Teledyne LeCroy oscilloscopes and probes are designed, built, and tested to ensure high reliability. In the unlikely event you experience difficulties, our digital oscilloscopes are fully warranted for three years and our probes are warranted for one year. This warranty includes:

- No charge for return shipping
- Long-term 7-year support
- Upgrade to latest software at no charge



1-800-5-LeCroy
teledynelecroy.com

**Local sales offices are located throughout the world.
Visit our website to find the most convenient location.**