

# Optocoupler, Photodarlington Output, AC Input, Internal R<sub>BE</sub>

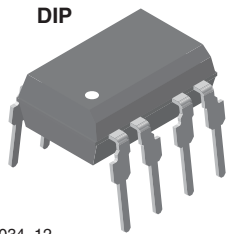

i179034\_12

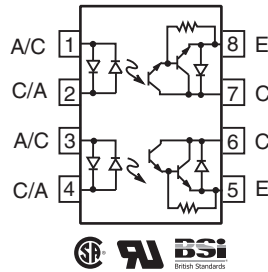

## FEATURES

- Internal R<sub>BE</sub> for better stability
- BV<sub>CEO</sub> > 60 V
- AC or polarity insensitive inputs
- Built-in reverse polarity input protection
- Industry standard DIP package
- Compliant to RoHS Directive 2002/95/EC and in accordance to WEEE 2002/96/EC

**RoHS**  
COMPLIANT

## APPLICATIONS

- Designed for applications requiring detection or monitoring of AC signals

## AGENCY APPROVALS

- UL1577, file no. E52744 system code H or J, double protection
- CSA 93751
- BSI IEC 60950; IEC 60065

ORDERING INFORMATION			
<div style="display: flex; justify-content: space-around; align-items: center;"> <div style="border: 1px solid black; padding: 2px 5px;">I</div> <div style="border: 1px solid black; padding: 2px 5px;">L</div> <div style="border: 1px solid black; padding: 2px 5px;">D</div> <div style="border: 1px solid black; padding: 2px 5px;">7</div> <div style="border: 1px solid black; padding: 2px 5px;">6</div> <div style="border: 1px solid black; padding: 2px 5px;">6</div> <div style="margin: 0 10px;">-</div> <div style="border: 1px solid black; padding: 2px 5px;">#</div> </div> <p style="text-align: center; margin-top: 5px;">PART NUMBER <span style="margin-left: 150px;">CTR BIN</span></p>			
AGENCY CERTIFIED/PACKAGE	CTR (%)		
	2 mA	1 mA	
UL, CSA, BSI	≥ 500	≥ 500	
DIP-8	ILD766-1	ILD766-2	

### Note

- Additional options may be possible, please contact sales office.

ABSOLUTE MAXIMUM RATINGS (T <sub>amb</sub> = 25 °C, unless otherwise specified)				
PARAMETER	TEST CONDITION	SYMBOL	VALUE	UNIT
<b>INPUT</b>				
Forward current		I <sub>F</sub>	60	mA
Power dissipation		P <sub>diss</sub>	90	mW
Derate linearly	from 25 °C		1.2	mW/°C
<b>OUTPUT</b>				
Collector emitter breakdown voltage		BV <sub>CEO</sub>	60	V
Collector base breakdown voltage		BV <sub>CBO</sub>	70	V
Power dissipation		P <sub>diss</sub>	100	mW
Derate linearly	from 25 °C		1.33	mW/°C



ABSOLUTE MAXIMUM RATINGS ( $T_{amb} = 25\text{ }^{\circ}\text{C}$ , unless otherwise specified)				
PARAMETER	TEST CONDITION	SYMBOL	VALUE	UNIT
<b>COUPLER</b>				
Total dissipation		$P_{tot}$	400	mW
Derate linearly	from 25 °C		5.3	mW/°C
Isolation test voltage	$t = 1\text{ s}$	$V_{ISO}$	5300	$V_{RMS}$
Isolation resistance	$T_{amb} = 25\text{ }^{\circ}\text{C}$	$R_{IO}$	$\geq 10^{12}$	$\Omega$
	$T_{amb} = 100\text{ }^{\circ}\text{C}$	$R_{IO}$	$\geq 10^{11}$	$\Omega$
Creepage distance			$\geq 7.0$	mm
Clearance distance			$\geq 7.0$	mm
Comparative tracking index per DIN IEC 112/VDE 0303, part 1		CTI	175	
Storage temperature		$T_{stg}$	- 55 to + 150	°C
Operating temperature		$T_{amb}$	- 55 to + 100	°C
Lead soldering time	at 260 °C		10	s

**Note**

- Stresses in excess of the absolute maximum ratings can cause permanent damage to the device. Functional operation of the device is not implied at these or any other conditions in excess of those given in the operational sections of this document. Exposure to absolute maximum ratings for extended periods of the time can adversely affect reliability.

ELECTRICAL CHARACTERISTICS ( $T_{amb} = 25\text{ }^{\circ}\text{C}$ , unless otherwise specified)						
PARAMETER	TEST CONDITION	SYMBOL	MIN.	TYP.	MAX.	UNIT
<b>INPUT</b>						
Forward voltage	$I_F = \pm 10\text{ mA}$	$V_F$		1.2	1.5	V
<b>OUTPUT</b>						
Collector emitter breakdown voltage	$I_C = 1.0\text{ mA}$	$BV_{CEO}$	60	75		V
Collector base breakdown voltage	$I_C = 10\text{ }\mu\text{A}$	$BV_{CBO}$	60	90		V
Collector emitter leakage current	$V_{CE} = 10\text{ V}$	$I_{CEO}$		10	100	nA
<b>COUPLER</b>						
Collector emitter saturation voltage	$I_F = \pm 10\text{ mA}, I_C = 10\text{ mA}$	$V_{CEsat}$			1.0	V

**Note**

- Minimum and maximum values are testing requirements. Typical values are characteristics of the device and are the result of engineering evaluation. Typical values are for information only and are not part of the testing requirements.

CURRENT TRANSFER RATIO ( $T_{amb} = 25\text{ }^{\circ}\text{C}$ , unless otherwise specified)						
PARAMETER	TEST CONDITION	SYMBOL	MIN.	TYP.	MAX.	UNIT
DC current transfer ratio	$V_{CE} = 5.0\text{ V}, I_F = \pm 2\text{ mA}$	$CTR_{DC}$	500			%

SWITCHING CHARACTERISTICS ( $T_{amb} = 25\text{ }^{\circ}\text{C}$ , unless otherwise specified)						
PARAMETER	TEST CONDITION	SYMBOL	MIN.	TYP.	MAX.	UNIT
Rise time	$V_{CC} = 10\text{ V}, I_F = \pm 2.0\text{ mA}, R_L = 100\text{ }\Omega$	$t_r$		100		$\mu\text{s}$
Fall time		$t_f$		100		

**TYPICAL CHARACTERISTICS** ( $T_{amb} = 25\text{ }^{\circ}\text{C}$ , unless otherwise specified)

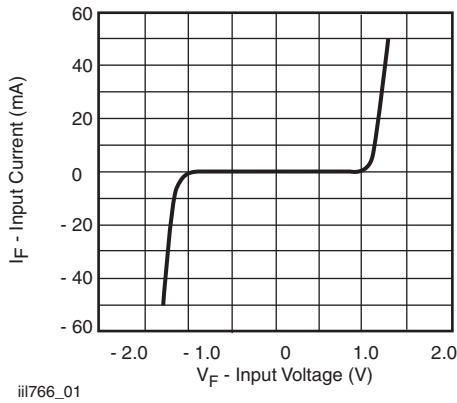

Fig. 1 - Input Characteristics

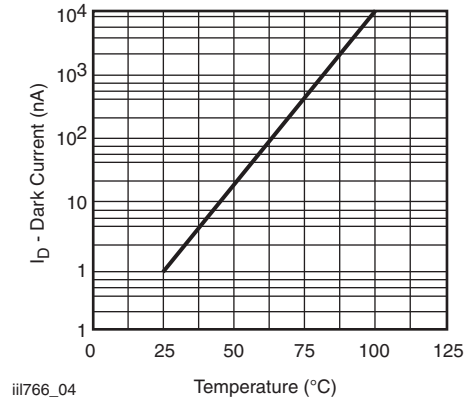

Fig. 4 -  $I_{CEO}$  at  $V_{CE} = 10\text{ V}$  vs. Temperature

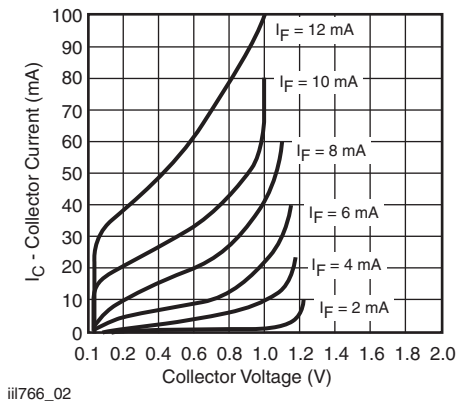

Fig. 2 - Transistor Current vs. Voltage

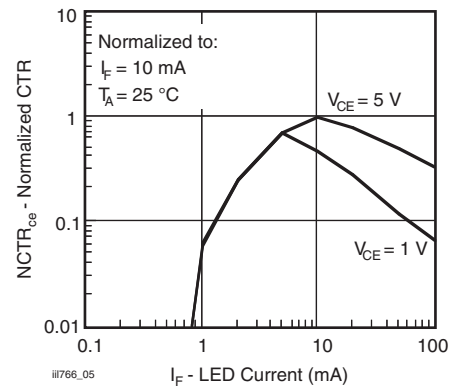

Fig. 5 - Normalized CTR vs. Forward Current

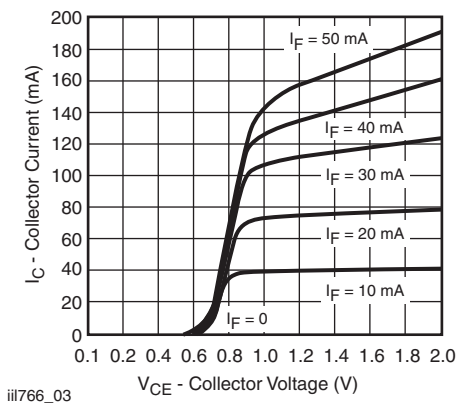

Fig. 3 - Transistor Output Current vs. Voltage

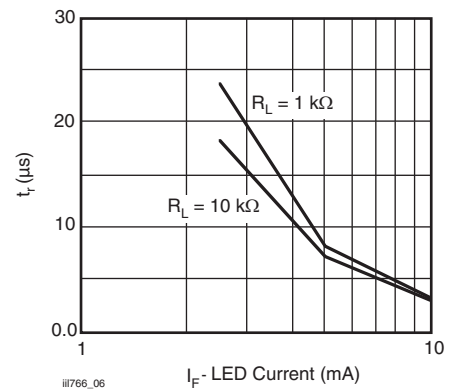
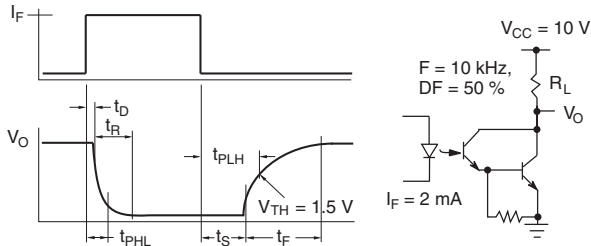
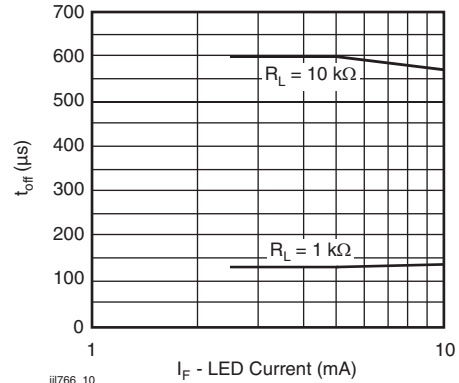

Fig. 6 -  $t_r$  vs. Forward Current



iii766\_07

Fig. 7 - Saturated Switching Characteristics Measurements-Schematic and Waveform



iii766\_10

Fig. 10 -  $t_{off}$  vs. Forward Current

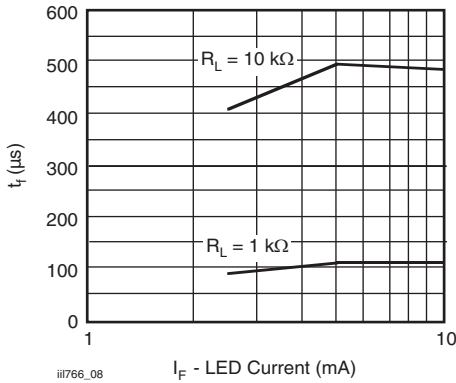

iii766\_08

Fig. 8 -  $t_{fall}$  vs. Forward Current

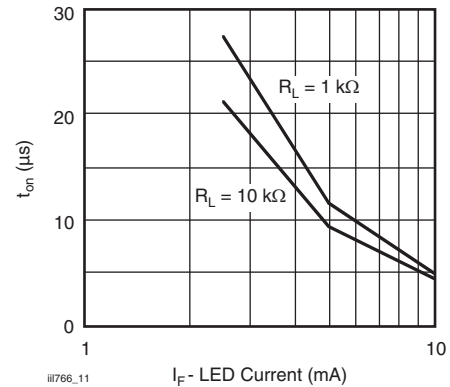

iii766\_11

Fig. 11 -  $t_{on}$  vs. Forward Current

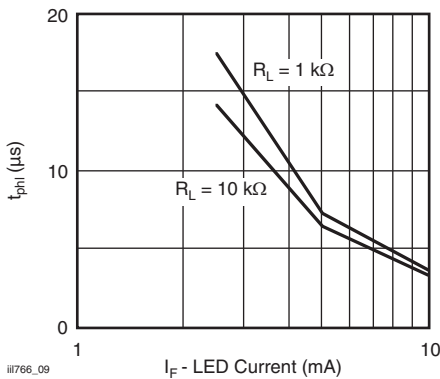

iii766\_09

Fig. 9 -  $t_{phl}$  vs. Forward Current

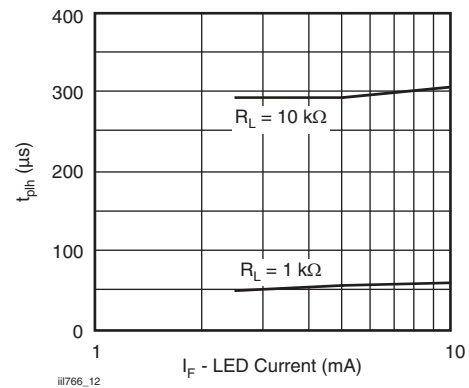

iii766\_12

Fig. 12 -  $t_{plh}$  vs. Forward Current



PACKAGE DIMENSIONS in millimeters

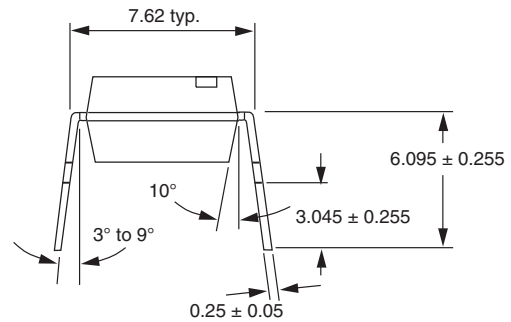
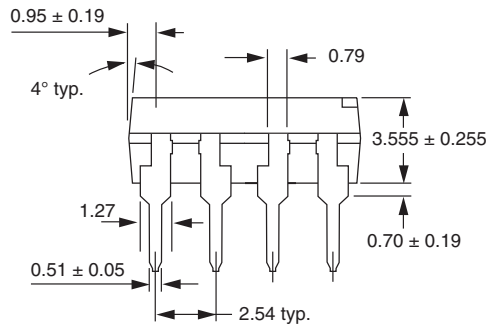
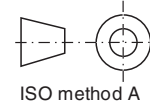
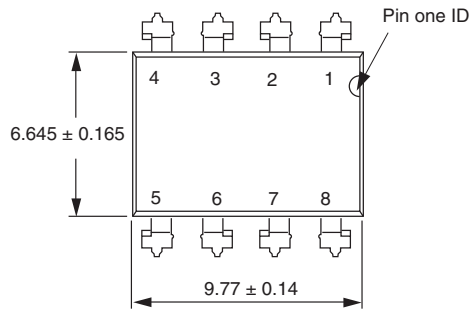

i178006

Option 7

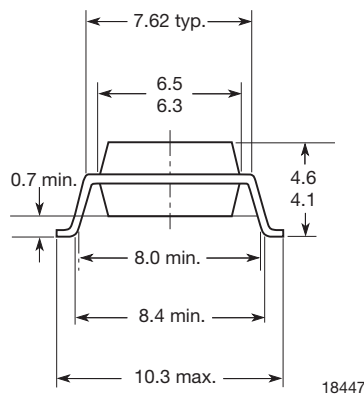

18447



## **Disclaimer**

ALL PRODUCT, PRODUCT SPECIFICATIONS AND DATA ARE SUBJECT TO CHANGE WITHOUT NOTICE TO IMPROVE RELIABILITY, FUNCTION OR DESIGN OR OTHERWISE.

Vishay Intertechnology, Inc., its affiliates, agents, and employees, and all persons acting on its or their behalf (collectively, "Vishay"), disclaim any and all liability for any errors, inaccuracies or incompleteness contained in any datasheet or in any other disclosure relating to any product.

Vishay makes no warranty, representation or guarantee regarding the suitability of the products for any particular purpose or the continuing production of any product. To the maximum extent permitted by applicable law, Vishay disclaims (i) any and all liability arising out of the application or use of any product, (ii) any and all liability, including without limitation special, consequential or incidental damages, and (iii) any and all implied warranties, including warranties of fitness for particular purpose, non-infringement and merchantability.

Statements regarding the suitability of products for certain types of applications are based on Vishay's knowledge of typical requirements that are often placed on Vishay products in generic applications. Such statements are not binding statements about the suitability of products for a particular application. It is the customer's responsibility to validate that a particular product with the properties described in the product specification is suitable for use in a particular application. Parameters provided in datasheets and / or specifications may vary in different applications and performance may vary over time. All operating parameters, including typical parameters, must be validated for each customer application by the customer's technical experts. Product specifications do not expand or otherwise modify Vishay's terms and conditions of purchase, including but not limited to the warranty expressed therein.

Except as expressly indicated in writing, Vishay products are not designed for use in medical, life-saving, or life-sustaining applications or for any other application in which the failure of the Vishay product could result in personal injury or death. Customers using or selling Vishay products not expressly indicated for use in such applications do so at their own risk. Please contact authorized Vishay personnel to obtain written terms and conditions regarding products designed for such applications.

No license, express or implied, by estoppel or otherwise, to any intellectual property rights is granted by this document or by any conduct of Vishay. Product names and markings noted herein may be trademarks of their respective owners.