

# High Performance IEC Inlet Filter



- Rated currents up to 20 A
- Optional medical versions (B type)
- Rear mounting
- Excellent attenuation in the lower frequency range



### Performance indicators

Attenuation performance



Rated current [A]



### Approvals



The FN 9246 IEC inlet filter combines an IEC inlet and mains filter with excellent filter attenuation in a small form factor. Choosing the FN 9246 product line brings you the rapid availability of a standard filter associated with the necessary safety acceptances. Standard IEC connector filters are a practical solution helping you to pass EMI system approval in a short time. A wide selection on current ratings and low leakage versions for medical applications are designed to offer you the desired solution.

### Features and benefits

- Excellent conducted attenuation performance, based on chokes with high saturation resistance and excellent thermal behavior
- Rear mounting
- Optional low leakage current versions for medical applications
- Rated currents up to 20 A
- Custom-specific versions are available on request

### Technical specifications

<b>Maximum continuous operating voltage</b>	250 VAC, 50/60 Hz
<b>Operating frequency</b>	DC to 400 Hz
<b>Rated currents</b>	1 to 20 A @ 50°C
<b>Approvals by rated current</b>	1 to 10 A (Semko) 16 A (Semko) for 16 and 20 A types 1 to 20 A (UL, CSA)
<b>High potential test voltage</b>	P → PE 2000 VAC for 2 sec (standard types) P → PE 2500 VAC for 2 sec (B types) P → N 1100 VAC for 2 sec (1 to 10 A types) P → N 1100 VDC for 2 sec (16 and 20 A types)
<b>Protection category</b>	IP 40 according to IEC 60529
<b>Temperature range (operation and storage)</b>	-25°C to +85°C (25/85/21)
<b>Design corresponding to</b>	UL 1283, CSA 22.2 No. 8 1986, IEC/EN 60939
<b>Flammability corresponding to</b>	UL 94 V-2 or better
<b>MTBF @ 40°C/230 V (Mil-HB-217F)</b>	1,600,000 hours

### Typical applications

- Electrical and electronic equipment
- Small to medium-sized machines and household equipment
- Single-phase power supplies, switch-mode power supplies
- Test and measurement equipment
- Building automation
- Medical equipment
- Lighting application

### Typical electrical schematic

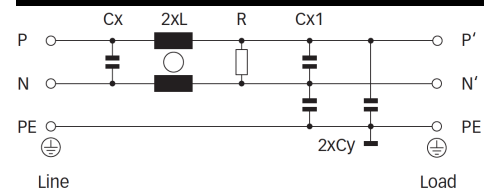

### Filter selection table

Filter	Rated current @ 40°C (25°C) [A]	Leakage current* @ 250 VAC/50 Hz (@ 120 VAC/60 Hz) [mA]	Inductance L [mH]	Capacitance		Resistance R [kΩ]	Output connections 	Weight [g]
				Cx [μF]	Cy [nF]			
FN 9246-1-06	1 (1.2)	0.31 (0.18)	50	1.22	2.2	470	-06	140
FN 9246-3-06	3 (3.5)	0.31 (0.18)	14	1.22	2.2	470	-06	140
FN 9246-6-06	6 (7.2)	0.31 (0.18)	7	1.22	2.2	470	-06	140
FN 9246-10-06	10 (12)	0.31 (0.18)	3	1.22	2.2	470	-06	140
FN 9246-12-06	12 (14)	0.31 (0.18)	1.85	1.22	2.2	470	-06	140
FN 9246-15-06	15 (18)	0.31 (0.18)	0.89	1.22	2.2	470	-06	140
FN 9246-16-06	16 (18.5)	0.66 (0.38)	2.5	1.22	4.7	470	-06	275
FN 9246-20-06	20 (23)	0.66 (0.38)	1.5	1.22	4.7	470	-06	275
FN 9246 B-1-06	1 (1.2)	0.00	50	1.22		470	-06	140
FN 9246 B-3-06	3 (3.5)	0.00	14	1.22		470	-06	140
FN 9246 B-6-06	6 (7.2)	0.00	7	1.22		470	-06	140
FN 9246 B-10-06	10 (11.6)	0.00	3	1.22		470	-06	140
FN 9246 B-12-06	12 (14)	0.00	1.85	1.22		470	-06	140
FN 9246 B-15-06	15 (18)	0.00	0.89	1.22		470	-06	140
FN 9246 B-16-06	16 (18.5)	0.00	2.5	1.22		470	-06	275
FN 9246 B-20-06	20 (23)	0.00	1.5	1.22		470	-06	275

\* Maximum leakage under normal operating conditions (acc. to IEC60939-3). Note: if the neutral line is interrupted, worst case leakage could reach twice this level.

### Typical filter attenuation

Per CISPR 17; A=50 Ω/50 Ω sym; B=50 Ω/50 Ω asym; C=0.1 Ω/100 Ω sym; D=100 Ω/0.1 Ω sym

1 A types

3 to 10 A types

12 and 15 A types

16 and 20 A types

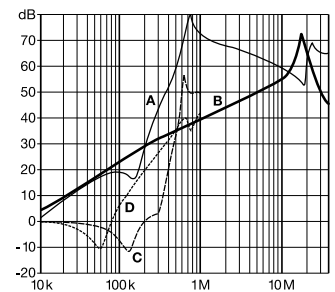
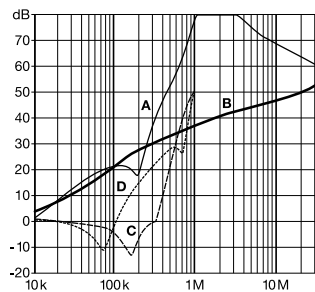
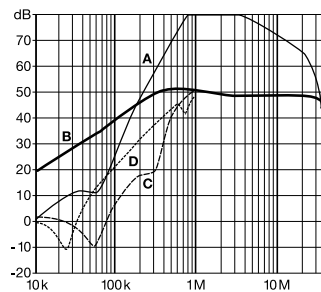
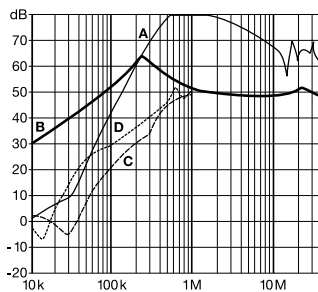

### Product selector

FN 9246x-yy--

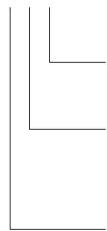

- 06: Faston 6.3 x 0.8mm (spade/soldering)
- 1 to 20: Rated current  
Standard IEC inlet type C14 (1 to 15A types), C20 (16 and 20A types)
- Blank: Standard version
- B: Medical version (with bleed resistor and without Y2-capacitor)

For example: FN 9246-6-06, FN 9246 B-10-06

**Mechanical data**

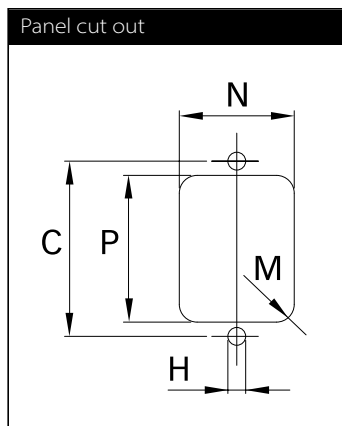
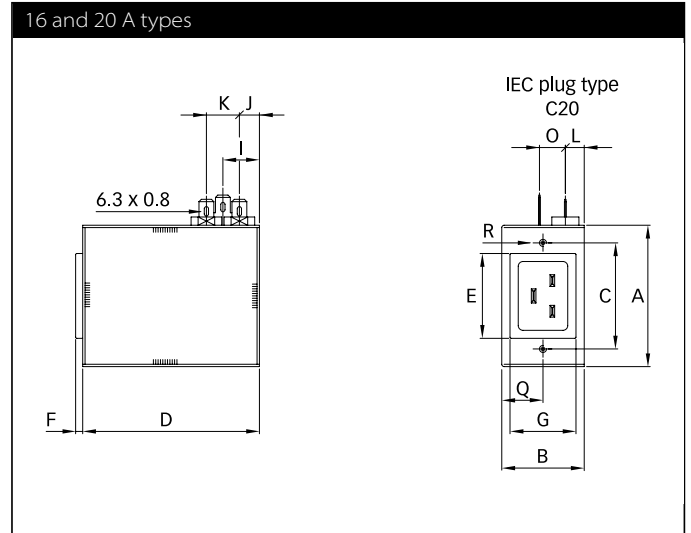
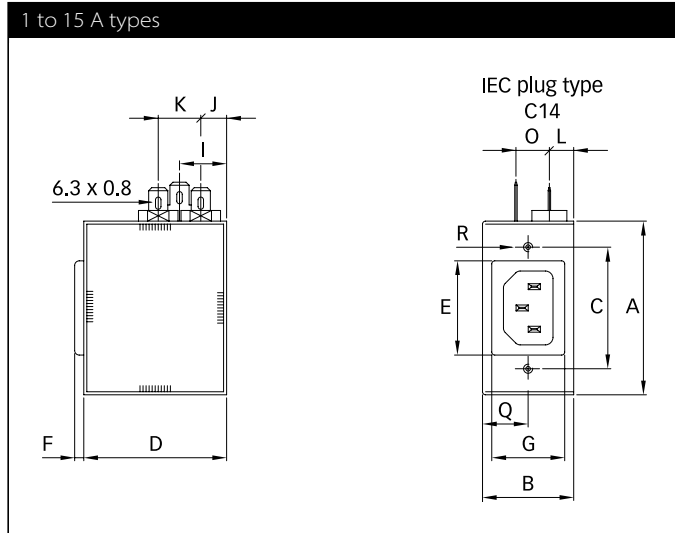

	1 A	3 A	6 A	10 A	12 A	15 A	16 A	20 A
<b>A</b>	57.15	57.15	57.15	57.15	57.15	57.15	60	60
<b>B</b>	30	30	30	30	30	30	35	35
<b>C</b>	40	40	40	40	40	40	45	45
<b>D</b>	47	47	47	47	47	47	75	75
<b>E</b>	31	31	31	31	31	31	36	36
<b>F</b>	3	3	3	3	3	3	3	3
<b>G</b>	24	24	24	24	24	24	28	28
<b>H</b>	Ø3.5	Ø3.5	Ø3.5	Ø3.5	Ø3.5	Ø3.5	Ø3.5	Ø3.5
<b>I</b>	15.5	15.5	15.5	15.5	15.5	15.5	15.5	15.5
<b>J</b>	8.5	8.5	8.5	8.5	8.5	8.5	8.5	8.5
<b>K</b>	14	14	14	14	14	14	14	14
<b>L</b>	8	8	8	8	8	8	8	8
<b>M</b>	R ≤1.5	R ≤1.5	R ≤1.5	R ≤1.5	R ≤1.5	R ≤1.5	R ≤1.5	R ≤1.5
<b>N</b>	25	25	25	25	25	25	29	29
<b>O</b>	11	11	11	11	11	11	11	11
<b>P</b>	32	32	32	32	32	32	37	37
<b>Q</b>	15	15	15	15	15	15	17.5	17.5
<b>R</b>				M3 x 10 max.				

All dimensions in mm; 1 inch = 25.4 mm  
Tolerances according: ISO 2768-m/EN 22768-m



## Headquarters, global innovation and development

### Switzerland

#### Schaffner Group

Nordstrasse 11  
4542 Luterbach  
T +41 32 681 66 26  
[info@schaffner.com](mailto:info@schaffner.com)  
<http://www.schaffner.com>



## Sales and application centers

### China

#### Schaffner EMC Ltd. Shanghai

T20-3 C, No 565 Chuangye Road,  
Pudong district  
201201 Shanghai  
T +86 21 3813 9500  
[cschina@schaffner.com](mailto:cschina@schaffner.com)  
<http://www.schaffner.com.cn>

### Finland

#### Schaffner Oy

Sauvonrinne 19 H  
08500 Lohja  
T +358 50 468 7284  
[finlandsales@schaffner.com](mailto:finlandsales@schaffner.com)

### France

#### Schaffner EMC S.A.S.

16-20 Rue Louis Rameau  
95875 Bezons  
T +33 1 34 34 30 60  
F +33 1 39 47 02 28  
[francesales@schaffner.com](mailto:francesales@schaffner.com)

### Germany

#### Schaffner Deutschland GmbH

Schoemperlenstrasse 12B  
76185 Karlsruhe  
T +49 721 56910  
F +49 721 569110  
[germanysales@schaffner.com](mailto:germanysales@schaffner.com)

### India

#### Schaffner India Pvt. Ltd

Unit 59, Level, Mfar Greenheart 7  
Manyata Tech Park, Hebbal Outer Ring Road  
560045 Bangalore  
T +91 80 6781 9805  
F +91 80 6781 9998  
[indiasales@schaffner.com](mailto:indiasales@schaffner.com)

### Italy

#### Schaffner EMC S.r.l.

Via Ticino, 30  
20900 Monza (MB)  
T +39 039 21 41 070  
[italysales@schaffner.com](mailto:italysales@schaffner.com)

### Japan

#### Schaffner EMC K.K.

1-32-12, Kamiyama, Setagaya-ku  
7F Mitsui-seimei Sengenjaya Bldg.  
154-0011 Tokyo  
T +81 3 5712 3650  
F +81 3 5712 3651  
[japansales@schaffner.com](mailto:japansales@schaffner.com)  
<http://www.schaffner.jp>

### Singapore

#### Schaffner EMC Pte Ltd.

#05-09, Kg Ubi Ind. Estate  
408705 Singapore  
T +65 6377 3283  
F +65 6377 3281  
[singaporesales@schaffner.com](mailto:singaporesales@schaffner.com)

### Spain

#### Schaffner EMC España

Calle Caléndula 93, Miniparc III, Edificio E  
El Soto de Moraleja, Alcobendas  
28109 Madrid  
T +34 917 912 900  
F +34 917 912 901  
[spainsales@schaffner.com](mailto:spainsales@schaffner.com)

### Sweden

#### Schaffner EMC AB

Tegeluddsvägen 76, 2tr  
115 28 Stockholm  
T +46 8 5050 2425  
[swedensales@schaffner.com](mailto:swedensales@schaffner.com)  
<http://www.schaffner.com>

### Switzerland

#### Schaffner EMV AG

Nordstrasse 11  
4542 Luterbach  
T +41 32 681 66 26  
[switzerlandsales@schaffner.com](mailto:switzerlandsales@schaffner.com)

### Taiwan R.O.C.

#### Schaffner EMV Ltd.

20 Floor-2, No 97, Section 1, XinTai 5th Road  
22175 XiZhi District New Taipei City 22175  
T +886 2 2697 5500  
F +886 2 2697 5533  
[taiwansales@schaffner.com](mailto:taiwansales@schaffner.com)  
<http://www.schaffner.com.tw>

### Thailand

#### Schaffner EMC Co. Ltd.

Northern Region Industrial Estate  
67 Moo 4 Tambon Ban Klang  
Amphur Muangng P.O. Box 14  
51000 Lamphun  
T +66 53 58 11 04  
F +66 53 58 10 19  
[thailandsales@schaffner.com](mailto:thailandsales@schaffner.com)

### United Kingdom

#### Schaffner Ltd.

5 Ashville Way, Molly Millars Lane  
Wokingham  
RG41 2PL Berkshire  
T +44 118 9770070  
F +44 118 9792969  
[uksales@schaffner.com](mailto:uksales@schaffner.com)

### USA

#### Schaffner EMC Inc.

52 Mayfield Avenue  
08837 Edison, New Jersey  
T +1 800 367 5566  
T +1 732 225 9533  
F +1 732 225 4789  
[usasales@schaffner.com](mailto:usasales@schaffner.com)  
<http://www.schaffnerusa.com>

#### Schaffner North America

6722 Thirlane Road  
24019 Roanoke, Virginia  
T +1 276 228 7943  
F +1 276 228 7953

#### Schaffner North America

823 Fairview Road  
24382 Wytheville, Virginia  
T +1 276 228 7943  
F +1 276 228 7258

To find your local partner within Schaffner's global network: [www.schaffner.com](http://www.schaffner.com)

© 2017 Schaffner Group

The content of this document has been carefully checked and understood. However, neither Schaffner nor its subsidiaries assume any liability whatsoever for any errors or inaccuracies of this document and the consequences thereof. Published specifications are subject to change without notice. Product suitability for any area of application must ultimately be determined by the customer. In all cases, products must never be operated outside their published specifications. Schaffner does not guarantee the availability of all published products. This disclaimer shall be governed by substantive Swiss law and resulting disputes shall be settled by the courts at the place of business of Schaffner Holding AG. Latest publications and a complete disclaimer can be downloaded from the Schaffner website. All trademarks recognized.