

Not Recommended for New Designs

This product was manufactured for Maxim by an outside wafer foundry using a process that is no longer available. It is not recommended for new designs. The data sheet remains available for existing users.

A Maxim replacement or an industry second-source may be available. Please see the QuickView data sheet for this part or contact technical support for assistance.

For further information, [contact Maxim's Applications Tech Support](#).



Single/Dual/Quad, 10MHz Single-Supply Op Amps

MAX473/MAX474/MAX475

General Description

The single MAX473, dual MAX474, and quad MAX475 are single-supply (2.7V to 5.25V), unity-gain-stable op amps with rail-to-rail output swing. Each op amp guarantees a 10MHz unity-gain bandwidth, 15V/μs slew rate, and 600Ω drive capability while typically consuming only 2mA supply current. In addition, the input range includes the negative supply rail and the output swings to within 50mV of each supply rail.

Single-supply operation makes these devices ideal for low-power and low-voltage portable applications. With their fast slew rate and settling time, they can replace higher-current op amps in large-signal applications. The MAX473/MAX474/MAX475 are available in DIP and SO packages in the industry-standard op-amp pin configurations. The MAX473 and MAX474 are also offered in the μMAX package, the smallest 8-pin SO.

Applications

- Portable Equipment
- Battery-Powered Instruments
- Signal Processing
- Discrete Filters
- Signal Conditioning
- Servo-Loops

Typical Operating Circuit

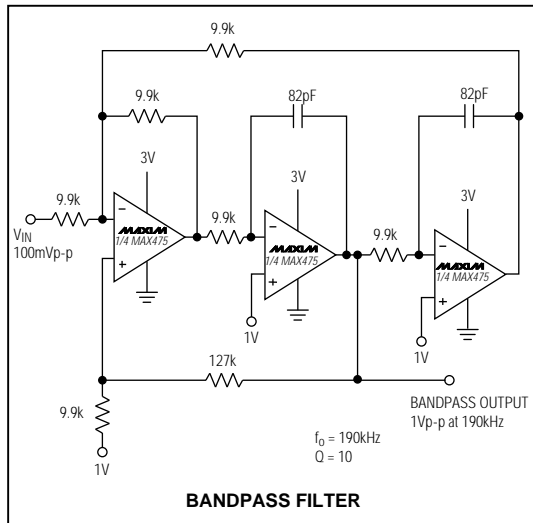

Features

- ♦ 15V/μs Min Slew Rate
- ♦ +3V Single-Supply Operation
- ♦ Guaranteed 10MHz Unity-Gain Bandwidth
- ♦ 2mA Supply Current per Amplifier
- ♦ Input Range Includes Negative Rail
- ♦ Outputs Short-Circuit Protected
- ♦ Rail-to-Rail Output Swing (to within ±50mV)
- ♦ μMAX Package (the smallest 8-pin SO)

Ordering Information

PART	TEMP. RANGE	PIN-PACKAGE
MAX473CPA	0°C to +70°C	8 Plastic DIP
MAX473CSA	0°C to +70°C	8 SO
MAX473CUA	0°C to +70°C	8 μMAX
MAX473C/D	0°C to +70°C	Dice*
MAX473EPA	-40°C to +85°C	8 Plastic DIP
MAX473ESA	-40°C to +85°C	8 SO
MAX473MJA	-55°C to +125°C	8 CERDIP

Ordering Information continued on last page.

* Dice are specified at TA = +25°C, DC parameters only.

Pin Configurations

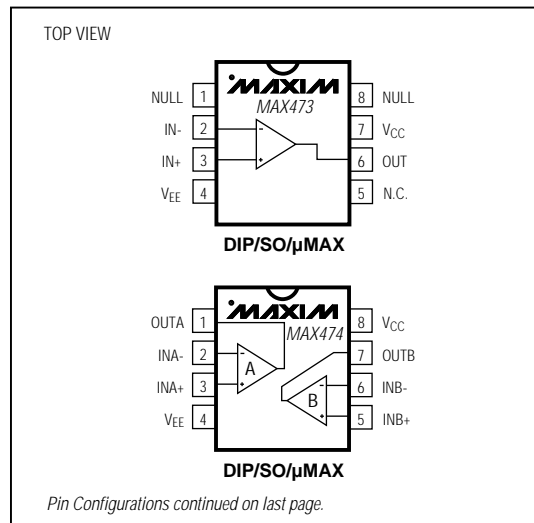

Pin Configurations continued on last page.



Single/Dual/Quad, 10MHz Single-Supply Op Amps

ABSOLUTE MAXIMUM RATINGS

Supply Voltage ($V_{CC} - V_{EE}$).....7V	14-Pin SO (derate 8.33mW/°C above +70°C).....667mW
Input Voltage (IN_+ , IN_- , IN_+ , IN_-).....($V_{CC} + 0.3V$) to ($V_{EE} - 0.3V$)	14-Pin CERDIP (derate 9.09mW/°C above +70°C).....727mW
Output Short-Circuit Duration.....Continuous	Operating Temperature Ranges
Continuous Power Dissipation ($T_A = +70^\circ C$)	MAX47_C_ _0°C to +70°C
8-Pin Plastic DIP (derate 9.09mW/°C above +70°C) ...727mW	MAX47_E_ _-40°C to +85°C
8-Pin SO (derate 5.88mW/°C above +70°C).....471mW	MAX47_MJ_-55°C to +125°C
8-Pin μ MAX (derate 4.1mW/°C above +70°C).....330mW	Junction Temperatures
8-Pin CERDIP (derate 8.00mW/°C above +70°C).....640mW	MAX47_C_ _/E_ _ +150°C
14-Pin Plastic DIP (derate 10.00mW/°C above +70°C)....800mW	MAX47_MJ_ +175°C
	Storage Temperature Range-65°C to +160°C
	Lead Temperature (soldering, 10sec)+300°C

Stresses beyond those listed under "Absolute Maximum Ratings" may cause permanent damage to the device. These are stress ratings only, and functional operation of the device at these or any other conditions beyond those indicated in the operational sections of the specifications is not implied. Exposure to absolute maximum rating conditions for extended periods may affect device reliability.

ELECTRICAL CHARACTERISTICS

(+3V $\leq V_{CC} \leq$ +5V, $V_{EE} = 0V$, $V_{CM} = 0.5V$, $V_{OUT} = 0.5V$, $T_A = +25^\circ C$, unless otherwise noted.)

PARAMETER	SYMBOL	CONDITIONS	MIN	TYP	MAX	UNITS
Input Offset Voltage	V _{OS}	MAX473		±0.70	±2.0	mV
		MAX474		±0.70	±2.0	
		MAX475		±0.80	±2.5	
Input Bias Current	I _B	Current flows out of terminals	0	80	150	nA
Input Offset Current	I _{OS}			±10	±30	nA
Common-Mode Voltage	V _{CM}	High	$V_{CC} - 1.9$	$V_{CC} - 1.7$		V
		Low		$V_{EE} - 0.1$	V_{EE}	
Common-Mode Rejection Ratio	CMRR	$V_{EE} \leq V_{CM} \leq (V_{CC} - 1.9V)$	80	90		dB
Power-Supply Rejection Ratio	PSRR	$V_{CC} = 2.7V$ to $6.0V$	80	90		dB
Input Noise-Voltage Density	e _n	f = 10kHz		40		nV/√Hz
Large-Signal Gain (Note 1)	A _{VOL}	$0.3V \leq V_{OUT} \leq (V_{CC} - 0.5V)$	R _L = no load		110	dB
			R _L = 10kΩ	94	105	
			R _L = 600Ω	82	90	
		Sinking 5mA	V _{CC} = 5V		76	
			V _{CC} = 3V		100	
			Sourcing 5mA	V _{CC} = 5V		
V _{CC} = 3V		90				
Output Voltage	V _{OH}	$V_{IN+} - V_{IN-} = +1V$, R _L = no load	$V_{CC} - 0.05$			V
	V _{OL}	$V_{IN+} - V_{IN-} = -1V$, R _L = no load			$V_{EE} + 0.05$	
Slew Rate	SR	$V_{CC} = 5V$, R _L = 10kΩ, C _L = 20pF, $V_{IN+} - V_{IN-} = +1V$ step	15	17		V/μs
Unity-Gain Bandwidth (Note 2)	GBW	$3V \leq V_{CC} \leq 5V$	10	12		MHz
		$V_{CC} = 2.7V$		10		

Single/Dual/Quad, 10MHz Single-Supply Op Amps

MAX473/MAX474/MAX475

ELECTRICAL CHARACTERISTICS (continued)

(+3V ≤ V_{CC} ≤ +5V, V_{EE} = 0V, V_{CM} = 0.5V, V_{OUT} = 0.5V, T_A = +25°C, unless otherwise noted.)

PARAMETER	SYMBOL	CONDITIONS	MIN	TYP	MAX	UNITS
Settling Time	t _S	To 0.1%, C _L = 20pF		400		ns
Power-Up Time	t _{PU}	A _v = +1, V _{IN} = 1/2 V _{CC} step, see <i>Typical Operating Characteristics</i>		700		ns
Overshoot		C _L = 150pF		10		%
		C _L = 20pF		5		
Phase Margin		R _L = 10kΩ, C _L = 20pF	V _{CC} = 5V	63		degrees
			V _{CC} = 3V	58		
Gain Margin		R _L = 10kΩ, C _L = 20pF	V _{CC} = 5V	10		dB
			V _{CC} = 3V	12		
Supply Current	I _S	Per amplifier		2.0	3.0	mA
Operating Supply-Voltage Range		Single supply	2.7		5.25	V
		Dual supplies	±1.35		±2.625	

ELECTRICAL CHARACTERISTICS

(+3V ≤ V_{CC} ≤ +5V, V_{EE} = 0V, V_{CM} = 0.5V, V_{OUT} = 0.5V, T_A = 0°C to +70°C, unless otherwise noted.)

PARAMETER	SYMBOL	CONDITIONS	MIN	TYP	MAX	UNITS
Input Offset Voltage	V _{OS}	MAX473			±2.0	mV
		MAX474			±2.0	
		MAX475			±3.0	
Input Bias Current	I _B	Current flows out of terminals	0		175	nA
Input Offset Current	I _{OS}				±35	nA
Common-Mode Rejection Ratio	CMRR	V _{EE} ≤ V _{CM} ≤ (V _{CC} - 1.9V)	78			dB
Power-Supply Rejection Ratio	PSRR	V _{CC} = 2.7V to 6.0V	78			dB
Large-Signal Gain (Note 1)	A _{VOL}	0.4V ≤ V _{OUT} ≤ (V _{CC} - 0.6V)	R _L = 10kΩ	94		dB
			R _L = 600Ω	80		
Output Voltage	V _{OH}	V _{IN+} - V _{IN-} = +1V, R _L = no load	V _{CC} - 0.07			V
	V _{OL}	V _{IN+} - V _{IN-} = -1V, R _L = no load		V _{EE} + 0.07		
Slew Rate	SR	V _{CC} = 5V, R _L = 10kΩ, C _L = 20pF, V _{IN+} - V _{IN-} = +1V step	12			V/μs
Supply Current	I _S	Per amplifier			3.3	mA
Operating Supply-Voltage Range		Single supply	2.7		5.25	V
		Dual supplies	±1.35		±2.625	

Single/Dual/Quad, 10MHz Single-Supply Op Amps

MAX473/MAX474/MAX475

ELECTRICAL CHARACTERISTICS

(+3V ≤ V_{CC} ≤ +5V, V_{EE} = 0V, V_{CM} = 0.5V, V_{OUT} = 0.5V, T_A = -40°C to +85°C, unless otherwise noted.)

PARAMETER	SYMBOL	CONDITIONS	MIN	TYP	MAX	UNITS
Input Offset Voltage	V _{OS}	MAX473			±2.3	mV
		MAX474			±2.3	
		MAX475			±3.3	
Input Bias Current	I _B	Current flows out of terminals	0		200	nA
Input Offset Current	I _{OS}				±50	nA
Common-Mode Rejection Ratio	CMRR	V _{EE} ≤ V _{CM} ≤ (V _{CC} - 2.0V)		72		dB
Power-Supply Rejection Ratio	PSRR	V _{CC} = 2.7V to 6.0V		72		dB
Large-Signal Gain (Note 1)	A _{VOL}	0.4V ≤ V _{OUT} ≤ (V _{CC} - 0.6V)	R _L = 10kΩ	94		dB
			R _L = 600Ω	72		
Output Voltage	V _{OH}	V _{IN+} - V _{IN-} = +1V, R _L = no load	V _{CC} - 0.08			V
	V _{OL}	V _{IN+} - V _{IN-} = -1V, R _L = no load	V _{EE} + 0.08			
Slew Rate	SR	V _{CC} = 5V, R _L = 10kΩ, C _L = 20pF, V _{IN+} - V _{IN-} = +1V step	10			V/μs
Supply Current	I _S	Per amplifier			3.4	mA
Operating Supply-Voltage Range		Single supply	2.7		5.25	V
		Dual supplies	±1.35		±2.625	

ELECTRICAL CHARACTERISTICS

(+3V ≤ V_{CC} ≤ +5V, V_{EE} = 0V, V_{CM} = 0.5V, V_{OUT} = 0.5V, T_A = -55°C to +125°C, unless otherwise noted.)

PARAMETER	SYMBOL	CONDITIONS	MIN	TYP	MAX	UNITS
Input Offset Voltage	V _{OS}	MAX473			±2.8	mV
		MAX474			±2.8	
		MAX475			±4.0	
Input Bias Current	I _B	Current flows out of terminals	0		225	nA
Input Offset Current	I _{OS}				±60	nA
Common-Mode Rejection Ratio	CMRR	V _{EE} ≤ V _{CM} ≤ (V _{CC} - 2.15V)		70		dB
Power-Supply Rejection Ratio	PSRR	V _{CC} = 2.7V to 6.0V		70		dB
Large-Signal Gain (Note 1)	A _{VOL}	0.5V ≤ V _{OUT} ≤ (V _{CC} - 0.6V)	R _L = 10kΩ	90		dB
			R _L = 600Ω	70		
Output Voltage	V _{OH}	V _{IN+} - V _{IN-} = +1V, R _L = no load	V _{CC} - 0.1			V
	V _{OL}	V _{IN+} - V _{IN-} = -1V, R _L = no load	V _{EE} + 0.1			
Slew Rate	SR	V _{CC} = 5V, R _L = 10kΩ, C _L = 20pF, V _{IN+} - V _{IN-} = +1V step	9			V/μs
Supply Current	I _S	Per amplifier			3.6	mA
Operating Supply-Voltage Range		Single supply	2.7		5.25	V
		Dual supplies	±1.35		±2.625	

Note 1: Gain decreases to zero as the output swings beyond the specified limits.

Note 2: Guaranteed by correlation to slew rate.

Single/Dual/Quad, 10MHz Single-Supply Op Amps

Typical Operating Characteristics

($V_{CC} = 5V$, $V_{EE} = 0V$, $T_A = +25^\circ C$, unless otherwise noted.)

MAX473/MAX474/MAX475

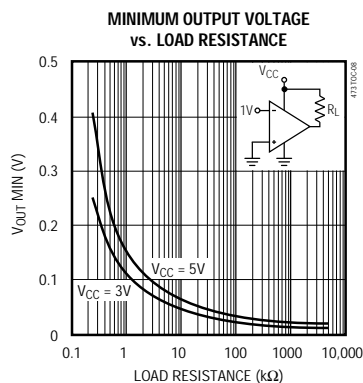
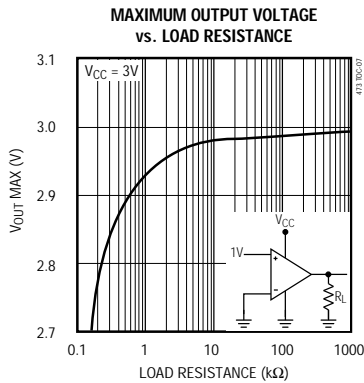
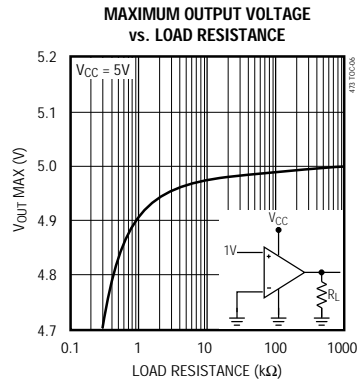
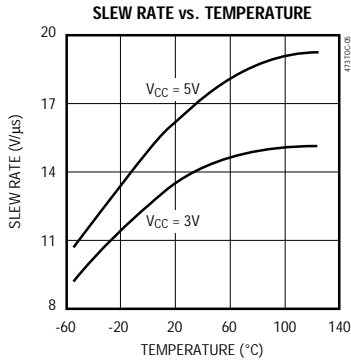
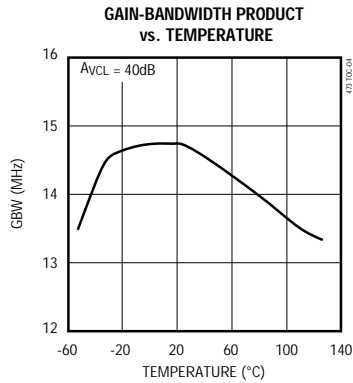
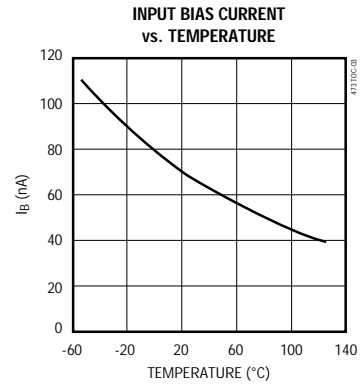
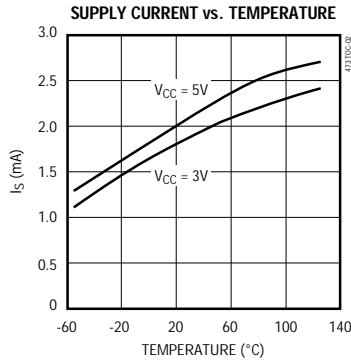
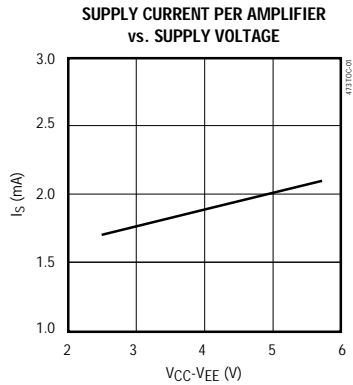

Single/Dual/Quad, 10MHz Single-Supply Op Amps

Typical Operating Characteristics (continued)
($V_{CC} = 5V$, $V_{EE} = 0V$, $T_A = +25^\circ C$, unless otherwise noted.)

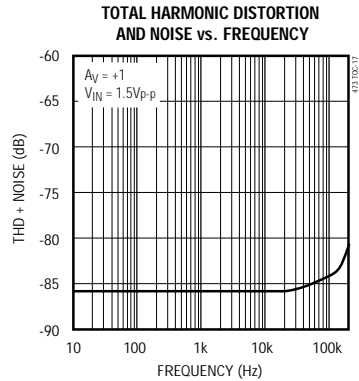
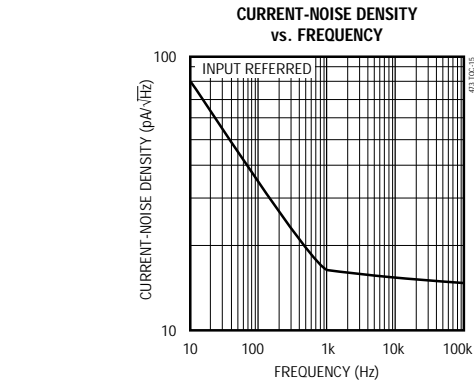
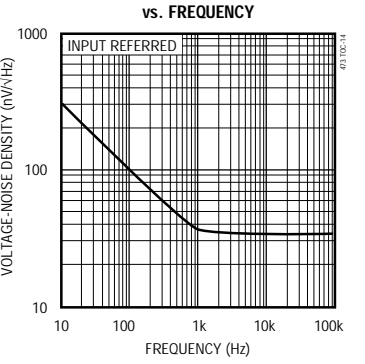
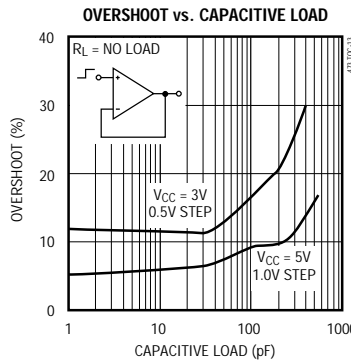
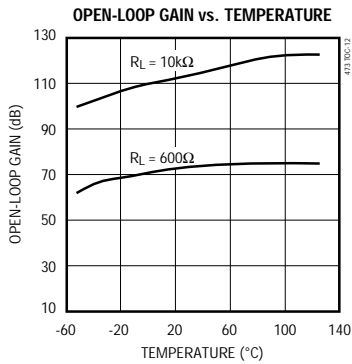
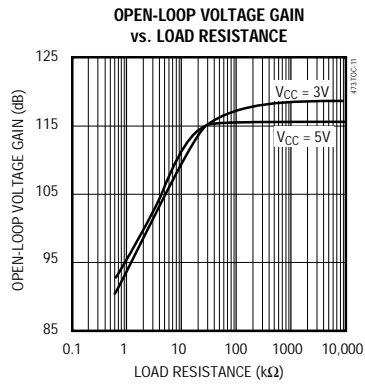
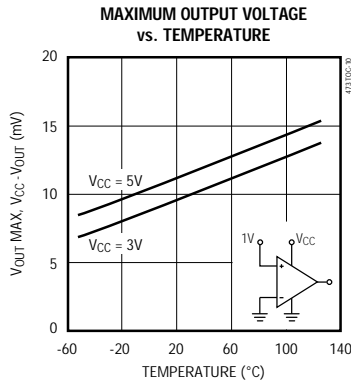
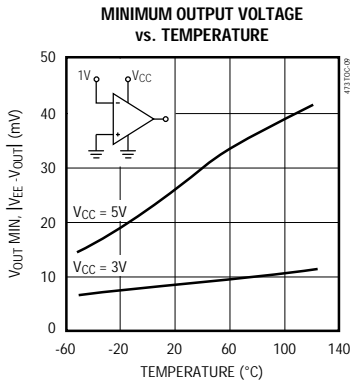

Single/Dual/Quad, 10MHz Single-Supply Op Amps

Typical Operating Characteristics (continued)

($V_{CC} = 5V$, $V_{EE} = 0V$, $T_A = +25^\circ C$, unless otherwise noted.)

MAX473/MAX474/MAX475

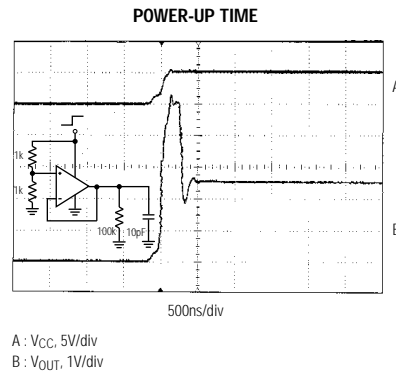
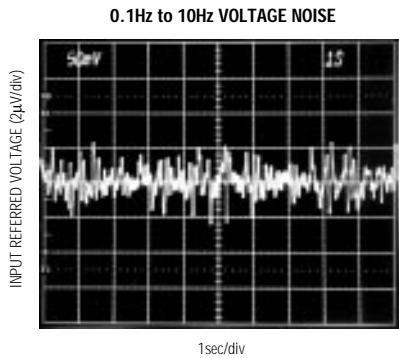
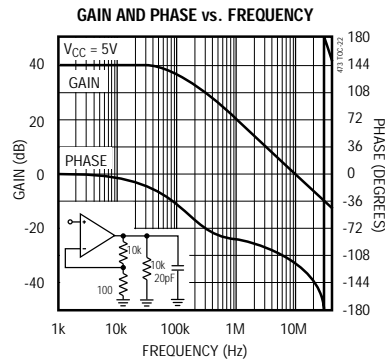
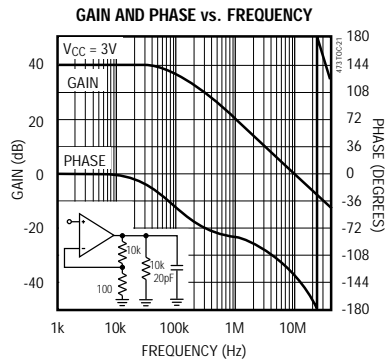
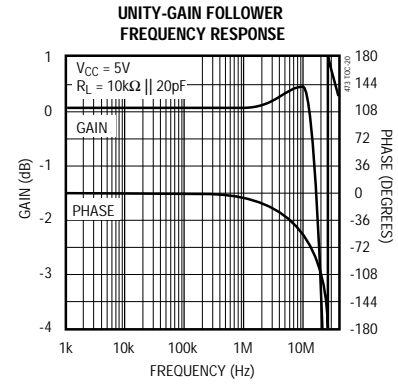
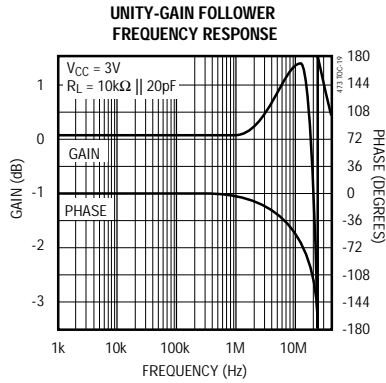
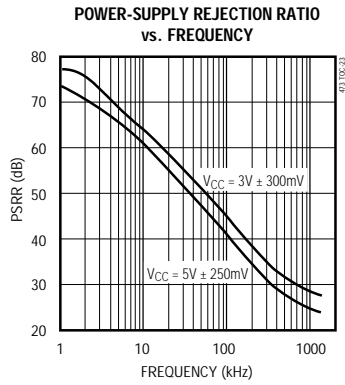

Single/Dual/Quad, 10MHz Single-Supply Op Amps

Typical Operating Characteristics (continued)
 (V_{CC} = 5V, V_{EE} = 0V, T_A = +25°C, unless otherwise noted.)

SMALL-SIGNAL TRANSIENT RESPONSE
 (V_{CC} = 5V)

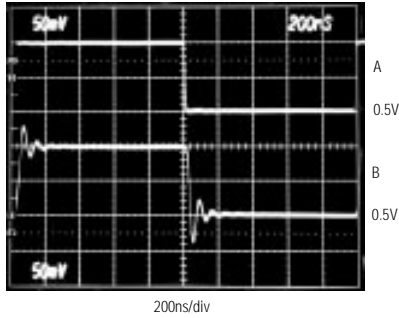

V_{CC} = 5V, A_v = +1, R_L = 10kΩ, C_L = 220pF
 A : V_{IN}, 50mV/div
 B : V_{OUT}, 50mV/div

SMALL-SIGNAL TRANSIENT RESPONSE
 (V_{CC} = 3V)

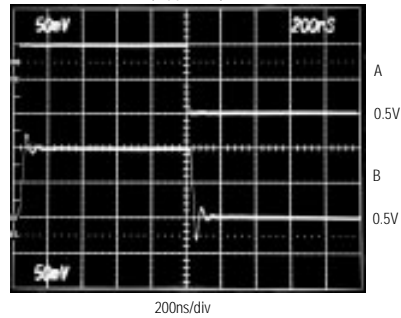

V_{CC} = 3V, A_v = +1, R_L = 10kΩ, C_L = 100pF
 A : V_{IN}, 50mV/div
 B : V_{OUT}, 50mV/div

LARGE-SIGNAL TRANSIENT RESPONSE

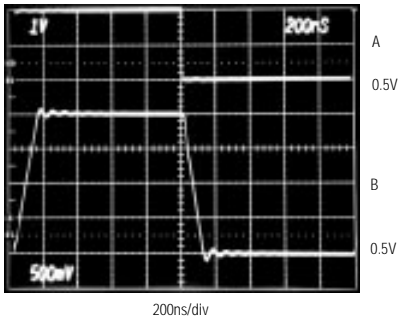

V_{CC} = 5V, A_v = +1, R_L = 10kΩ, C_L = 220pF
 A : V_{IN}, 1V/div
 B : V_{OUT}, 500mV/div

OVERDRIVING THE OUTPUT

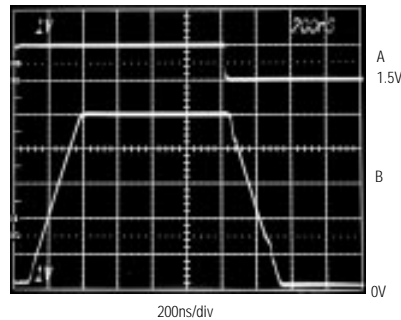

V_{CC} = 5V, V_{IN-} = 2.0V, R_L = 10kΩ, C_L = 33pF
 A : V_{IN+}, 1V/div
 B : V_{OUT}, 1V/div

Single/Dual/Quad, 10MHz Single-Supply Op Amps

Pin Description

MAX473/MAX474/MAX475

PIN			NAME	FUNCTION
MAX473	MAX474	MAX475		
1, 8	—	—	NULL	Offset Null Input. Connect to one end of 2k Ω potentiometer for offset voltage trimming. Connect wiper to V _{EE} . See Figure 1.
—	1	1	OUTA	Amplifier A Output
2	—	—	IN-	Inverting Input
—	2	2	INA-	Amplifier A Inverting Input
3	—	—	IN+	Noninverting Input
—	3	3	INA+	Amplifier A Noninverting Input
4	4	11	V _{EE}	Negative Power-Supply Pin. Connect to ground or a negative voltage.
5	—	—	N.C.	No Connect—not internally connected
—	5	5	INB+	Amplifier B Noninverting Input
6	—	—	OUT	Amplifier Output
—	6	6	INB-	Amplifier B Inverting Input
—	7	7	OUTB	Amplifier B Output
7	8	4	V _{CC}	Positive Power-Supply Pin. Connect to (+) terminal of power supply.
—	—	8	OUTC	Amplifier C Output
—	—	9	INC-	Amplifier C Inverting Input
—	—	10	INC+	Amplifier C Noninverting Input
—	—	12	IND+	Amplifier D Noninverting Input
—	—	13	IND-	Amplifier D Inverting Input
—	—	14	OUTD	Amplifier D Output

Applications Information

Power Supplies

The MAX473/MAX474/MAX475 operate from a single 2.7V to 5.25V power supply, or from dual supplies of $\pm 1.35V$ to $\pm 2.625V$. For single-supply operation, bypass the power supply with 0.1 μF . If operating from dual supplies, bypass each supply to ground. With 0.1 μF bypass capacitance, channel separation (MAX474/MAX475) is typically better than 120dB with signal frequencies up to 300kHz. Increasing the bypass capacitance (e.g. 10 μF || 0.1 μF) maintains channel separation at higher frequencies.

Minimizing Offsets

The MAX473's maximum offset voltage is $\pm 2mV$ (T_A = +25°C). If additional offset adjustment is required, connect a 2k Ω trim potentiometer between pins 1, 8, and 4 (Figure 1). Input offset voltage for the dual MAX474 and quad MAX475 cannot be externally trimmed.

The MAX473/MAX474/MAX475 are bipolar op amps with low input bias currents. The bias currents at both inputs flow out of the device. Matching the resistance at the op amp's inputs significantly reduces the offset error caused by the bias currents. Place a resistor (R3) from the noninverting input to ground when using the inverting configuration (Figure 2a); place R3 in series with the noninverting input when using the noninverting configuration (Figure 2b). Select R3 such that the parallel combination of R2 and R1 equals R3. Adding R3 will slightly increase the op amp's voltage noise.

Output Loading and Stability

The MAX473/MAX474/MAX475 op amps are unity-gain stable. Any op amp's stability depends on the configuration, closed-loop gain, and load capacitance. The unity-gain, noninverting buffer is the most sensitive gain configuration, and driving capacitive loads decreases stability.

Single/Dual/Quad, 10MHz Single-Supply Op Amps

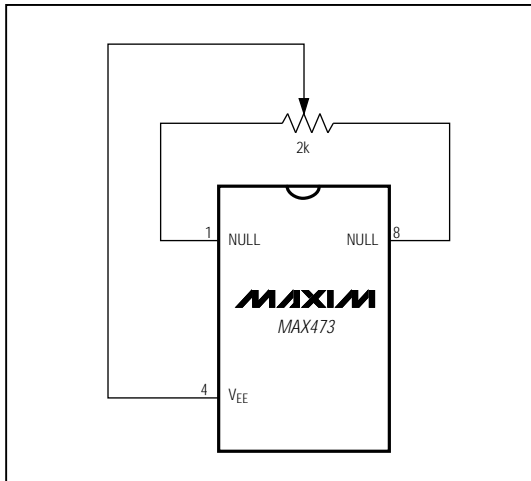

Figure 1. Offset Null Circuit

The MAX473/MAX474/MAX475 have excellent phase margin (the difference between 180° and the unity-gain phase angle). It is typically 63° with a load of 10kΩ in parallel with 20pF. Generally, higher phase margins indicate greater stability.

Capacitive loads form an RC network with the op amp's output resistance, causing additional phase shift that reduces the phase margin. Figure 3 shows the MAX473/MAX474/MAX475 output response when driving a 390pF load in parallel with 10kΩ.

When driving large capacitive loads, add an output isolation resistor, as shown in Figure 4. This resistor improves the phase margin by isolating the load capacitance from the amplifier output. Figure 5 shows the MAX473/MAX474/MAX475 driving a capacitive load of 1000pF using the circuit of Figure 4.

Feedback Resistors

The feedback resistors appear as a resistance network to the op amp's feedback input (Figure 2). This resistance, combined with the op amp's input and stray capacitance (total input capacitance), forms a pole that adds unwanted phase shift when either the total input capacitance or feedback resistance is too large. For example, using the noninverting configuration with a gain of 10, if the total capacitance at the negative input is 10pF and the effective resistance ($R1 \parallel R2$) is 9kΩ, this RC network introduces a pole at $f_0 = 1.8\text{MHz}$. At

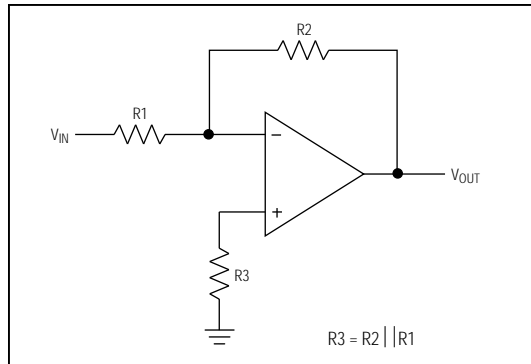

Figure 2a. Reducing Offset Error Due to Bias Current: Inverting Configuration

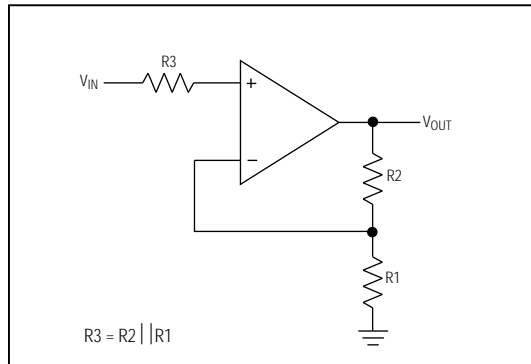

Figure 2b. Reducing Offset Error Due to Bias Current: Noninverting Configuration

input frequencies above f_0 , the pole introduces additional phase shift, which reduces the overall bandwidth and adversely affects stability. Choose feedback resistors small enough so they do not adversely affect the op amp's operation at the frequencies of interest.

Overdriving the Outputs

The output voltage swing for specified operation is from ($V_{EE} + 0.3\text{V}$) to ($V_{CC} - 0.5\text{V}$) (see *Electrical Characteristics*). Exercising the outputs beyond these limits drives the output transistors toward saturation, resulting in bandwidth degradation, response-time increase, and gain decrease (which affects linearity). Operation in this region causes a slight distortion in the output waveform, but does not adversely affect the op amp.

Single/Dual/Quad, 10MHz Single-Supply Op Amps

MAX473/MAX474/MAX475

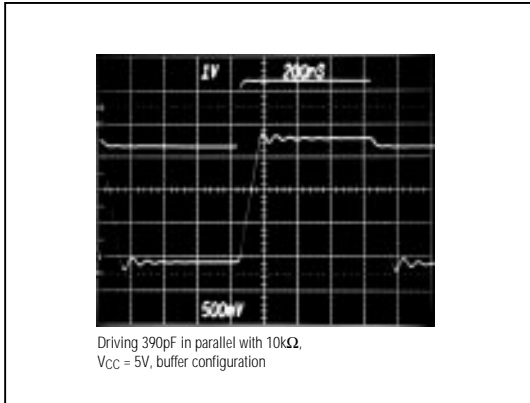

Figure 3. MAX474 Driving 390pF

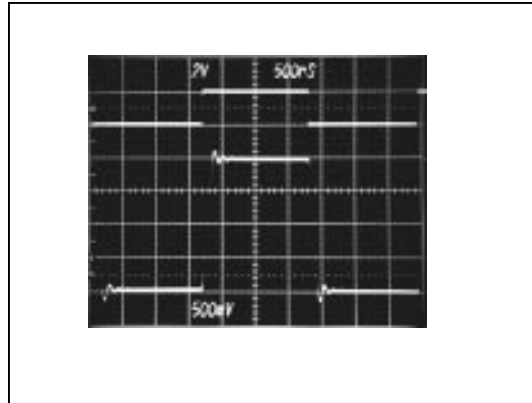

Figure 5. The MAX473 easily drives 1000pF using the Capacitive-Load Driving Circuit (Figure 4).

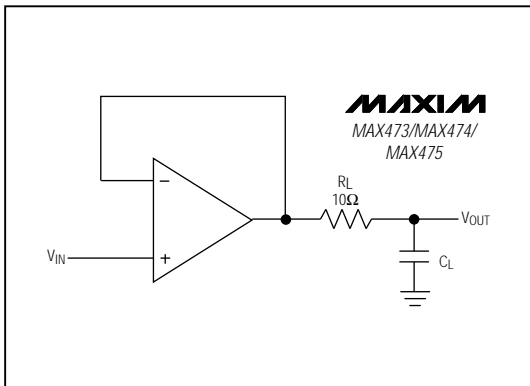

Figure 4. Capacitive-Load Driving Circuit

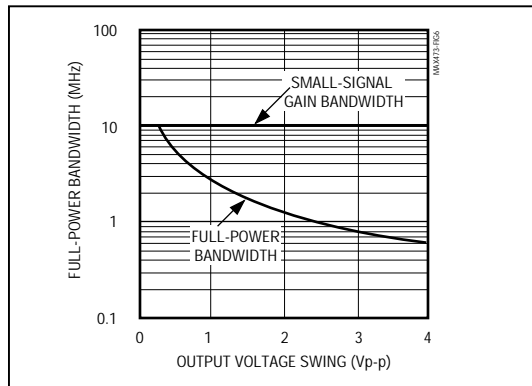

Figure 6. Full-Power Bandwidth vs. Peak-to-Peak AC Voltage

Full-Power Bandwidth

The MAX473/MAX474/MAX475's fast 15V/μs slew rate maximizes full-power bandwidth (FPBW). The FPBW is given by:

$$\text{FPBW (Hz)} = \frac{\text{SR}}{\pi [\text{V}_{\text{OUT peak-to-peak(max)}}]}$$

where the slew rate (SR) is 15V/μs min. Figure 6 shows the full-power bandwidth as a function of the peak-to-peak AC output voltage.

Layout

A good layout improves performance by decreasing the amount of stray capacitance at the amplifier's inputs and output. Since stray capacitance might be unavoidable, minimize trace lengths and resistor leads, and place external components as close to the pins as possible.

Single/Dual/Quad, 10MHz Single-Supply Op Amps

Ordering Information (continued)

PART	TEMP. RANGE	PIN-PACKAGE
MAX474 CPA	0°C to +70°C	8 Plastic DIP
MAX474CSA	0°C to +70°C	8 SO
MAX474CUA	0°C to +70°C	8 μ MAX
MAX474C/D	0°C to +70°C	Dice*
MAX474EPA	-40°C to +85°C	8 Plastic DIP
MAX474ESA	-40°C to +85°C	8 SO
MAX474MJA	-55°C to +125°C	8 CERDIP
MAX475 CPD	0°C to +70°C	14 Plastic DIP
MAX475CSD	0°C to +70°C	14 SO
MAX475EPD	-40°C to +85°C	14 Plastic DIP
MAX475ESD	-40°C to +85°C	14 SO
MAX475MJD	-55°C to +125°C	14 CERDIP

* Dice are specified at $T_A = +25^\circ\text{C}$, DC parameters only.

Pin Configurations (continued)

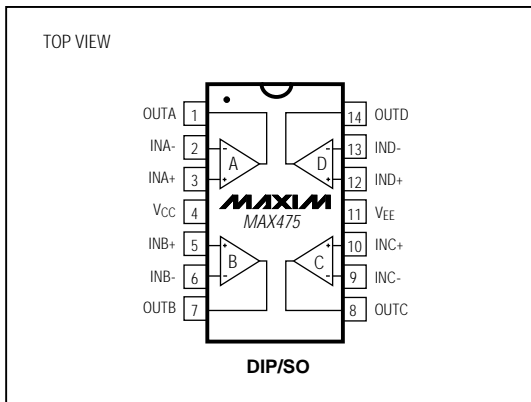

Chip Topographies

MAX473

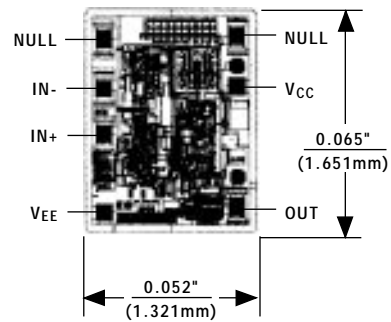

TRANSISTOR COUNT: 185
SUBSTRATE CONNECTED TO VEE

MAX474

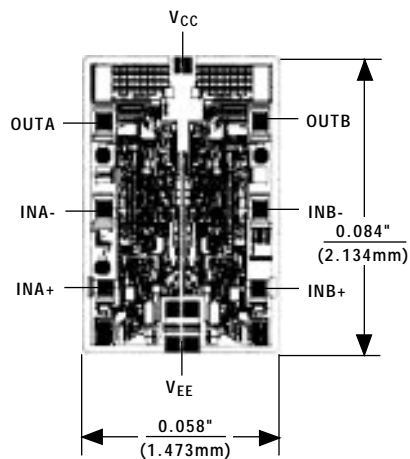

TRANSISTOR COUNT: 355
SUBSTRATE CONNECTED TO VEE

Maxim cannot assume responsibility for use of any circuitry other than circuitry entirely embodied in a Maxim product. No circuit patent licenses are implied. Maxim reserves the right to change the circuitry and specifications without notice at any time.

12 Maxim Integrated Products, 120 San Gabriel Drive, Sunnyvale, CA 94086 (408) 737-7600