

THE INFORMATION CONTAIN HEREIN IS PROPRIETARY TO HIROSE ELECTRIC (USA), INC.. ALL RIGHTS THEREIN ARE RESERVED AND SHALL NOT BE USED, DUPLICATED, OR FURTHER DISSEMINATED FOR ANY PURPOSE WITHOUT THE CONSENT OF HIROSE ELECTRIC (USA), INC.

M3 SOCKET HEAD CAP SCREW, 12 mm LONG, SHOWN FOR REFERENCE ONLY, NOT INSTALLED

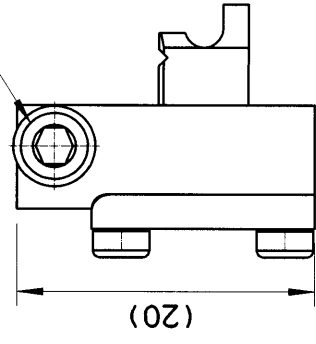

M3 FLAT HEAD PHILLIPS MACHINE SCREW, 6 mm LONG, SHOWN FOR REFERENCE ONLY, NOT INSTALLED

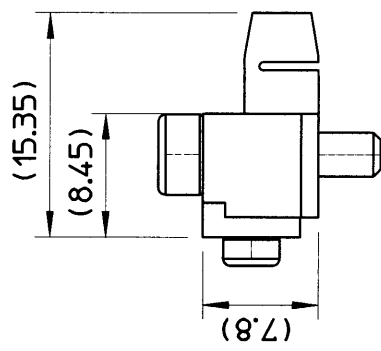
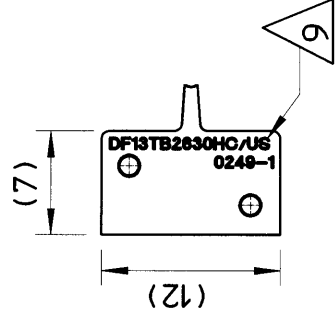

CUT PUNCH ASSY

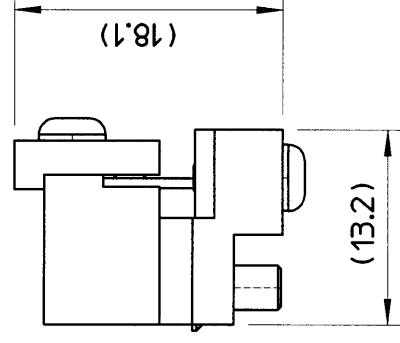

CONTACT FEEDER ASSY

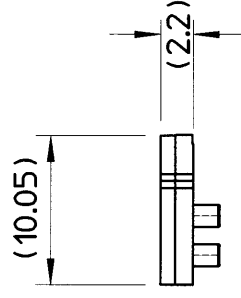

ANVIL ASSY

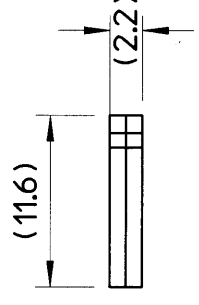

CRIMPER ASSY

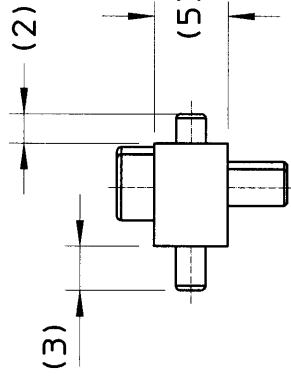

PUNCH STOPPER ASSY

M2.5 SOCKET HEAD CAP SCREW, 10 mm LONG, SHOWN FOR REFERENCE ONLY, NOT INSTALLED

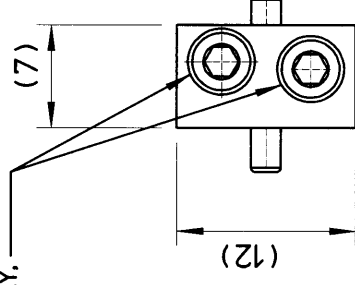
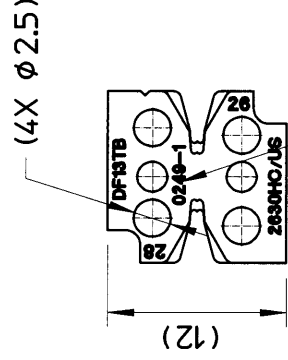
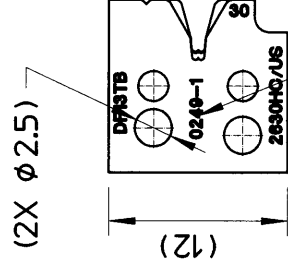

DATE CODE EXPLANATION:

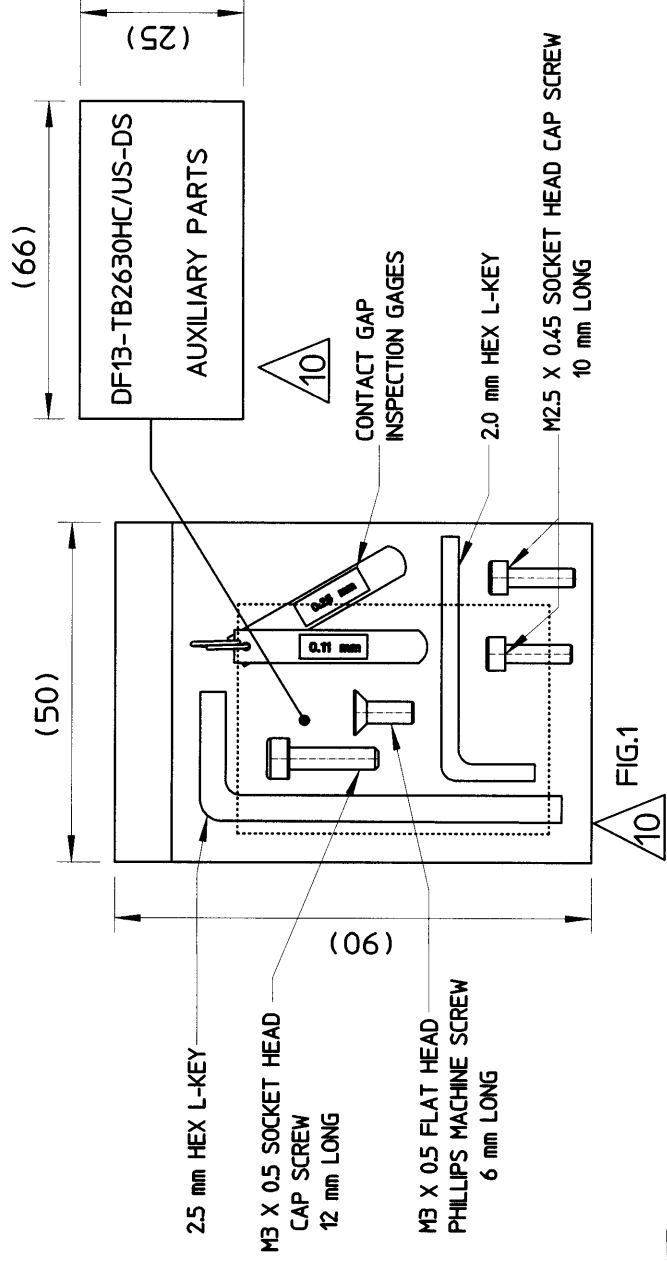
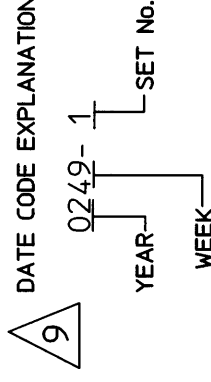

FIG.1

REVISIONS				
ZONE	REV.	DESCRIPTION	DATE	APPROVED
	A	REVISED PER DCN# 0896		
	B	REVISED PER DCN# 0913	11/26/03	A.S.
	C	REVISED PER DCN# 0923	2/2/04	M.N.

FORM NO. 0AG18

UNLESS OTHERWISE SPECIFIED DIMENSIONS ARE IN MILLIMETERS TOLERANCES ARE:
 X = ±0.1
 .XX = ±0.05
 .XXX = ±0.03
 ANGLE = ±1°

PROJECT NO.	DATE
XXXXXXXXXX	05/05/03
DESIGNED BY	APPROVALS
Luis Lostanaou	
CHECKED BY	CL NUMBER
XXXXXXXXXX	5920-8502-5
USED ON	SIZE
DF13-TB2630HC/US-DS	B
APPLICATION	DWG NUMBER
	DF13-TB2630HC/US-DS
	SCALE
	N/A
	SHEET
	2 OF 2
	REV.
	C

CUSTOMER USE DRAWING

HRS
 HIROSE ELECTRIC (U.S.A), INC
 SIMI VALLEY, CALIFORNIA 93065

PART NUMBER
DF13-TB2630HC/US-DS

CL NUMBER
5920-8502-5

SCALE
 N/A

SHEET
 2 OF 2

REV.
 C

DWG NO.
 DF13-TB2630HC/US-DS

SHT.
 2

REV.
 C

DATE
 11/26/03

APPROVED
 A.S.

DATE
 2/2/04

APPROVED
 M.N.

SCALE
 N/A

SHEET
 2 OF 2

REV.
 C

DWG NUMBER
 DF13-TB2630HC/US-DS

SCALE
 N/A

SHEET
 2 OF 2

REV.
 C

DWG NUMBER
 DF13-TB2630HC/US-DS

SCALE
 N/A

SHEET
 2 OF 2

REV.
 C

DWG NUMBER
 DF13-TB2630HC/US-DS

SCALE
 N/A

SHEET
 2 OF 2

REV.
 C

DWG NUMBER
 DF13-TB2630HC/US-DS

SCALE
 N/A

SHEET
 2 OF 2

REV.
 C

DWG NUMBER
 DF13-TB2630HC/US-DS

SCALE
 N/A

SHEET
 2 OF 2

REV.
 C

DWG NUMBER
 DF13-TB2630HC/US-DS

SCALE
 N/A

SHEET
 2 OF 2

REV.
 C

DWG NUMBER
 DF13-TB2630HC/US-DS

SCALE
 N/A

SHEET
 2 OF 2

REV.
 C

DWG NUMBER
 DF13-TB2630HC/US-DS

SCALE
 N/A

SHEET
 2 OF 2

REV.
 C

DWG NUMBER
 DF13-TB2630HC/US-DS

SCALE
 N/A

SHEET
 2 OF 2

REV.
 C

DWG NUMBER
 DF13-TB2630HC/US-DS

SCALE
 N/A

SHEET
 2 OF 2

REV.
 C

DWG NUMBER
 DF13-TB2630HC/US-DS

SCALE
 N/A

SHEET
 2 OF 2

REV.
 C

DWG NUMBER
 DF13-TB2630HC/US-DS

SCALE
 N/A

SHEET
 2 OF 2

REV.
 C

DWG NUMBER
 DF13-TB2630HC/US-DS

SCALE
 N/A

SHEET
 2 OF 2

REV.
 C

DWG NUMBER
 DF13-TB2630HC/US-DS

SCALE
 N/A

SHEET
 2 OF 2

REV.
 C

DWG NUMBER
 DF13-TB2630HC/US-DS

SCALE
 N/A

SHEET
 2 OF 2

REV.
 C

DWG NUMBER
 DF13-TB2630HC/US-DS

SCALE
 N/A

SHEET
 2 OF 2

REV.
 C

DWG NUMBER
 DF13-TB2630HC/US-DS

SCALE
 N/A

SHEET
 2 OF 2

REV.
 C

DWG NUMBER
 DF13-TB2630HC/US-DS

SCALE
 N/A

SHEET
 2 OF 2

REV.
 C

DWG NUMBER
 DF13-TB2630HC/US-DS

SCALE
 N/A

SHEET
 2 OF 2

REV.
 C

DWG NUMBER
 DF13-TB2630HC/US-DS

SCALE
 N/A

SHEET
 2 OF 2

REV.
 C

DWG NUMBER
 DF13-TB2630HC/US-DS

SCALE
 N/A

SHEET
 2 OF 2

REV.
 C

DWG NUMBER
 DF13-TB2630HC/US-DS

SCALE
 N/A

SHEET
 2 OF 2

REV.
 C

DWG NUMBER
 DF13-TB2630HC/US-DS

SCALE
 N/A

SHEET
 2 OF 2

REV.
 C

DWG NUMBER
 DF13-TB2630HC/US-DS

SCALE
 N/A

SHEET
 2 OF 2

REV.
 C

DWG NUMBER
 DF13-TB2630HC/US-DS

SCALE
 N/A

SHEET
 2 OF 2

REV.
 C

DWG NUMBER
 DF13-TB2630HC/US-DS

SCALE
 N/A

SHEET
 2 OF 2

REV.
 C

DWG NUMBER
 DF13-TB2630HC/US-DS

SCALE
 N/A

SHEET
 2 OF 2

REV.
 C

DWG NUMBER
 DF13-TB2630HC/US-DS

SCALE
 N/A

SHEET
 2 OF 2

REV.
 C

DWG NUMBER
 DF13-TB2630HC/US-DS

SCALE
 N/A

SHEET
 2 OF 2

REV.
 C

DWG NUMBER
 DF13-TB2630HC/US-DS

SCALE
 N/A

SHEET
 2 OF 2

REV.
 C

DWG NUMBER
 DF13-TB2630HC/US-DS

SCALE
 N/A

SHEET
 2 OF 2

REV.
 C

DWG NUMBER
 DF13-TB2630HC/US-DS

SCALE
 N/A

SHEET
 2 OF 2

REV.
 C

DWG NUMBER
 DF13-TB2630HC/US-DS

SCALE
 N/A

SHEET
 2 OF 2

REV.
 C

DWG NUMBER
 DF13-TB2630HC/US-DS

SCALE
 N/A

SHEET
 2 OF 2

REV.
 C

DWG NUMBER
 DF13-TB2630HC/US-DS

SCALE
 N/A

SHEET
 2 OF 2

REV.
 C

DWG NUMBER
 DF13-TB2630HC/US-DS

SCALE
 N/A

SHEET
 2 OF 2

REV.
 C

DWG NUMBER
 DF13-TB2630HC/US-DS

SCALE
 N/A

SHEET
 2 OF 2

REV.
 C

DWG NUMBER
 DF13-TB2630HC/US-DS

SCALE
 N/A

SHEET
 2 OF 2

REV.
 C

DWG NUMBER
 DF13-TB2630HC/US-DS

SCALE
 N/A

SHEET
 2 OF 2

REV.
 C

DWG NUMBER
 DF13-TB2630HC/US-DS

SCALE
 N/A

SHEET
 2 OF 2

REV.
 C

DWG NUMBER
 DF13-TB2630HC/US-DS

SCALE
 N/A

SHEET
 2 OF 2

REV.
 C

DWG NUMBER
 DF13-TB2630HC/US-DS

SCALE
 N/A

SHEET
 2 OF 2

REV.
 C

DWG NUMBER
 DF13-TB2630HC/US-DS

SCALE
 N/A

SHEET
 2 OF 2

REV.
 C

DWG NUMBER
 DF13-TB2630HC/US-DS

SCALE
 N/A

SHEET
 2 OF 2

REV.
 C

DWG NUMBER
 DF13-TB2630HC/US-DS

SCALE
 N/A

SHEET
 2 OF 2

REV.
 C

DWG NUMBER
 DF13-TB2630HC/US-DS

SCALE
 N/A

SHEET
 2 OF 2

REV.
 C

DWG NUMBER
 DF13-TB2630HC/US-DS

SCALE
 N/A

SHEET
 2 OF 2

REV.
 C

DWG NUMBER
 DF13-TB2630HC/US-DS

SCALE
 N/A