

GIGA-TRIM

Giga-Trims® are tiny trimmer capacitors which provide a straight-forward technique for fine RF and microwave circuits by eliminating time consuming methods of abrasive trimming, cut and try adjustment techniques, and interchange of fixed capacitors.

The design evolved from the need for a virtually indestructible miniature trimmer with superior electrical characteristics. Giga-Trim® capacitors withstand the rigors of soldering heat, excessive tuning and rough handling. As a result of the excellent dielectric and insulation properties of the sapphire housing, high breakdown voltage is achieved. Incorporating the patented self-locking constant torque drive mechanism* which eliminates the need for external bushing slots, the new Giga-Trim® offers many improvements: a fixed length, increased Q, essentially zero tuning noise and reduced susceptibility to solder flux intrusion during installation.

A variety of mounting styles is available for vertical, printed circuit, panel, cavity and strip-line applications.

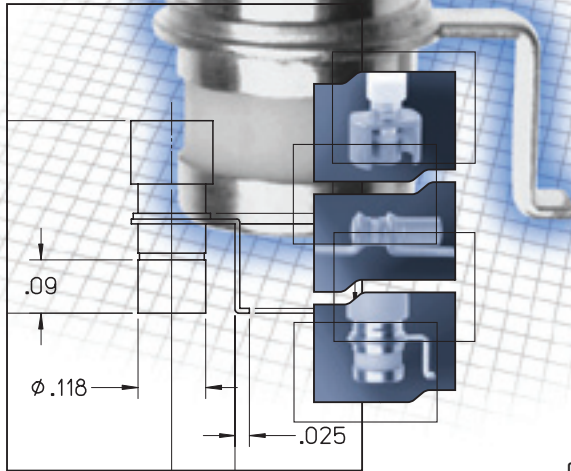

APPLICATIONS

- RF amplifier
- Impedance matching
- Crystal trimming
- Interstage coupling
- Filter tuning

CHARACTERISTICS

- Working Voltage: 500 VDC (1000 VDC Test)
- Long rotational life
- Insulation resistance: > 10⁶ MΩ
- Temperature range: -65°C to +125°C
- RoHS compliant

CAPACITANCE RANGE	SERIES	Q @ 250 MHZ	PAGE
0.3 TO 1.2 pF	27260	> 5000	2
0.4 TO 2.5 pF	27280	> 4000	2
	47280	> 4000	3
0.3 TO 2.3 pF	47480	> 2000	3
0.6 TO 4.5 pF	17270	> 2000	3
	27270	> 3000	3
	47270	> 3000	3
	57280	> 1000**	3
0.8 TO 8.0 pF	27290	> 3000*	4
	57270	> 1000*	4
2.0 TO 6.0 pF	47470	> 1500**	4

* @ 100MHz ** @ 200 MHz

TERMINAL CONFIGURATION



0.3 to 1.2 pF

- Capacitance Range: 0.3 to 1.2 pF (>5 turns)
- Working Voltage: 500 VDC (1000 VDC Test)
- Torque: 0.1 to 1 oz. In.
- Tuning Tool: 8762 or 8762-1
- Optional Seal Cap: P4445-1 or P4446-1
- RoHS Compliant

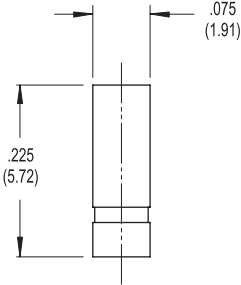
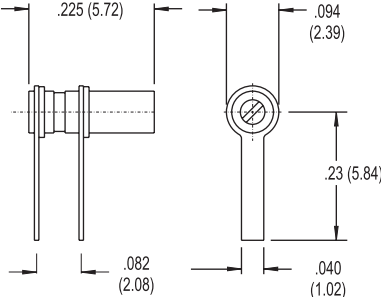
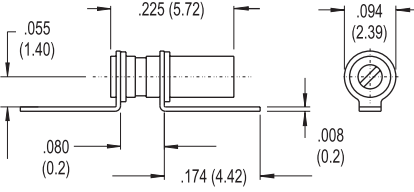
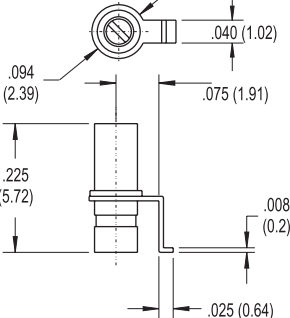
<p>27260 Q @ 250 MHz >5000 Sapphire</p>	
<p>27261 Q @ 250 MHz >5000 Sapphire</p>	
<p>27261SL Q @ 250 MHz >5000 Sapphire</p>	
<p>27263 Q @ 250 MHz >5000 Sapphire</p> <p>Available in Tape/Reel 27263-2R2 1000 pcs/Reel</p>	

0.4 to 2.5 pF

- Capacitance Range: 0.4 to 2.5 pF (>4 turns)
- Working Voltage: 500 VDC (1000 VDC Test)
- Torque: 0.2 to 2 oz. In.
- Tuning Tool: 8766 or 8766-1
- Optional Seal Cap: P4445 or P4446
- RoHS Compliant

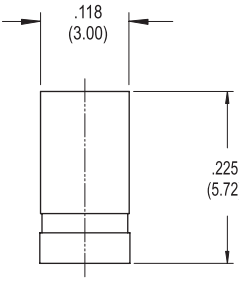
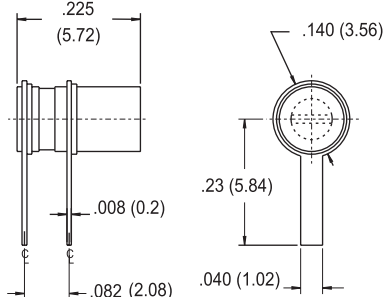
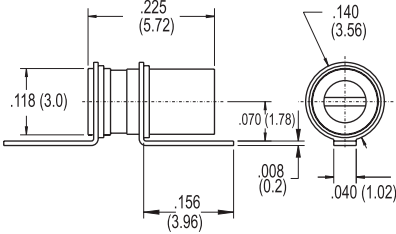
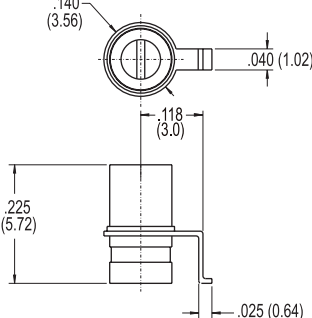
<p>27280 Q @ 250 MHz >4000 Sapphire</p>	
<p>27281 Q @ 250 MHz >4000 Sapphire</p>	
<p>27281SL Q @ 250 MHz >4000 Sapphire</p>	
<p>27283 Q @ 250 MHz >4000 Sapphire</p> <p>Available in Tape/Reel 27283-3R10 750 pcs/Reel</p>	

0.4 TO 2.5 pF

<p>47283</p> <p>Q @ 250 MHz >4000 Alumina</p> <p>Available in Tape/Reel 47283-R10 750 pcs/Reel</p>	
<p>47483</p> <p>(0.3 to 2.3 pF) Q @ 237 MHz >2000 Alumina</p> <p>Available in Tape/Reel 47483-R10 750 pcs/Reel</p>	

0.6 TO 4.5 pF

<p>27271SL</p> <p>Q @ 250 MHz >3000 Sapphire</p>	
<p>27273</p> <p>Q @ 250 MHz >3000 Sapphire</p> <p>Available in Tape/Reel 27273-3R5 400 pcs/Reel</p>	

0.6 TO 4.5 pF

- Capacitance Range: 0.6 to 4.5 pF (>8 turns)
- Working Voltage: 500 VDC (1000 VDC Test)
- Torque: 0.2 to 2 oz. In.
- Tuning Tool: 8766 or 8766-1
- Optional Seal Cap: P4445 or P4446
- RoHS Compliant

<p>27270</p> <p>Q @ 250 MHz >3000 Sapphire</p>	
<p>27271</p> <p>Q @ 250 MHz >3000 Sapphire</p>	

<p>17273</p> <p>Q @ 250 MHz >2000 Alumina</p> <p>Available in Tape/Reel 17273R5 400 pcs/Reel</p>	
<p>47273</p> <p>Q @ 250 MHz >3000 Alumina</p> <p>Available in Tape/Reel 47273R5 400 pcs/Reel</p>	
<p>57283-1</p> <p>Q @ 200 MHz >1000 Zirconia</p> <p>Available in Tape/Reel 57283-1R10 750 pcs/Reel</p>	

0.8 TO 8.0 pF

- Capacitance Range: 0.8 to 8.0 pF (>16 turns)
- Working Voltage: 500 VDC (1000 VDC Test)
- Torque: 0.2 to 2 oz. In.
- Tuning Tool: 8766 or 8766-1
- Optional Seal Cap: P4445 or P4446
- RoHS Compliant

<p>27290 Q @ 100 MHz >3000 Sapphire</p>	
<p>27291 Q @ 100 MHz >3000 Sapphire</p>	

<p>27291SL Q @ 100 MHz >3000 Sapphire</p>	
<p>27293 Q @ 100 MHz >3000 Sapphire</p>	
<p>57273-1 Q @ 100 MHz >2000 Zirconia</p> <p>Available in Tape/Reel 57273-1R5 400 pcs/Reel</p>	

2.0 TO 6.0 pF

- Capacitance Range: 2.0 to 6.0 pF (>6 turns)
- Working Voltage: 500 VDC (1000 VDC Test)
- Torque: 0.2 to 2 oz. In.
- Tuning Tool: 8766 or 8766-1
- RoHS Compliant

<p>47473 Q @ 213 MHz >1500 Alumina</p> <p>Available in Tape/Reel 47473R5 400 pcs/Reel</p>	
--	--

