



THIS INFORMATION IS CONFIDENTIAL AND PROPRIETARY TO CW INDUSTRIES INCORPORATED AND ITS AFFILIATES. IT MAY NOT BE DISCLOSED TO ANYONE, OTHER THAN CW INDUSTRIES PERSONNEL, WITHOUT WRITTEN AUTHORIZATION FROM CW INDUSTRIES INCORPORATED, SOUTHAMPTON, PENNSYLVANIA USA.

Rating	12(4)A 250V ac   cUL US	Mounting Hole		Circuit Diagram	
Contact Resistance	50m ohm Max.				
Insulation Resistance	DC 500V 100M ohm Min.				
Dielectric Strength	AC 1500V 1 minute				
Switch Function	6P DPDT ON-ON				
Operation Temperature	0°0~85°C				

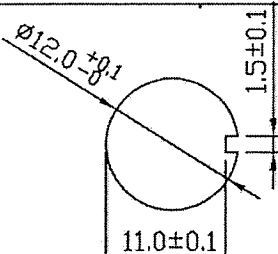
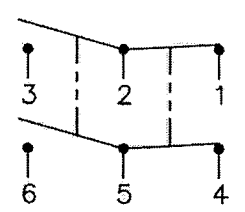
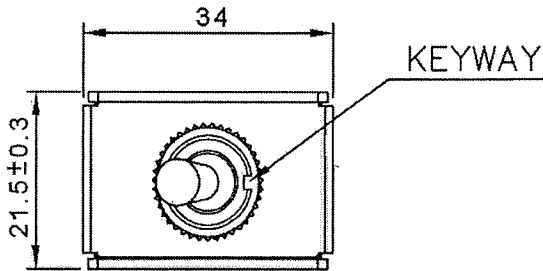

**MATERIAL:**

Frame: Nylon 6/6, Black  
 UL Flame: 94-V0  
 Lever: Metal  
 Terminal: Copper Alloy

Water proof and Dust Proof  
 to fit IP-56

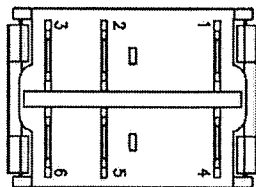
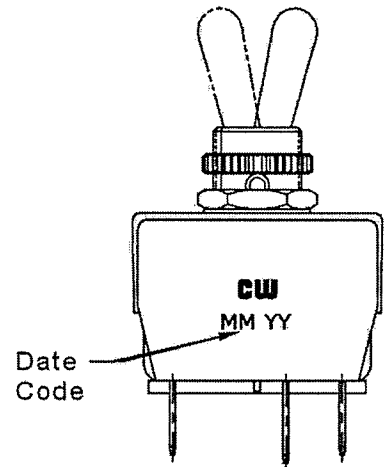
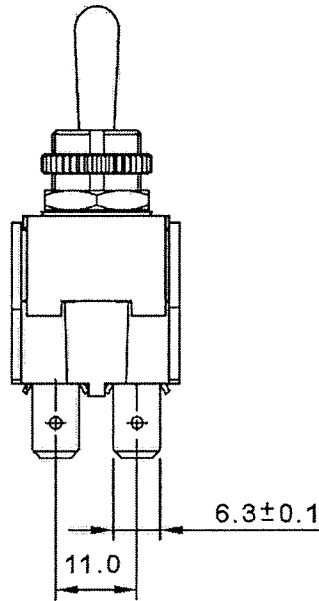
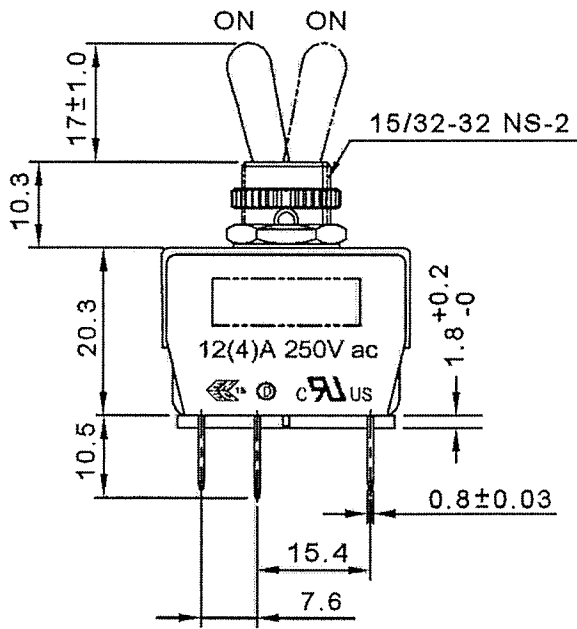

Tolerances Unless Otherwise Specified +/-0.5.

RoHS Compliant

5 Updated views, Materials & dimensions. 3-06-13.

**CW INDUSTRIES**  
 Southampton, Pa. 18966  
 Tel 215.355.7080/www.cwind.com

Date Drawn: 1/28/11

Rev. 5

Unit: mm

Checked By: *G. Guld*

Title:  
**TOGGLE SWITCH**

CW P/N:  
**GTS448B101A1HR**