

PLEASE CHECK WWW.MOLEX.COM FOR LATEST PART INFORMATION

Part Number: [63813-4200](#)
Status: **Active**
Description: Extractor Tool for 5-Way Male Housing

Documents:
[RoHS Certificate of Compliance \(PDF\)](#)

General

Product Family	Application Tooling
Series	T0201
Comments	See Tooling Specification (PDF) Above
Function	Extraction
Geographic Area	Global
Level of Automation	Manual
More Detailed Tech Information	applicationtooling@molex.com
Product Name	N/A
Survey	www.molex.com//review/apptool_survey.html
Tool Type	Handtool
UPC	884982002944

Material Info

Reference - Drawing Numbers

Application Tooling Documents	ATS-638134200
-------------------------------	---------------

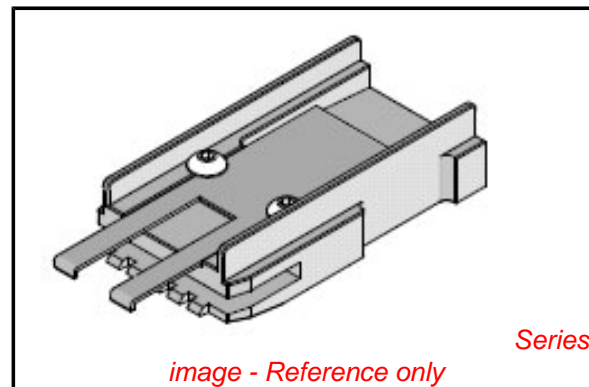

EU RoHS

**ELV and RoHS
Compliant**

REACH SVHC

Not Reviewed

Low-Halogen Status

Not Reviewed

China RoHS



**Need more information on product
environmental compliance?**

Email productcompliance@molex.com
For a multiple part number RoHS Certificate of
Compliance, [click here](#)

Please visit the [Contact Us](#) section for any
non-product compliance questions.

Search Parts in this Series

T0201Series

Use With

98781 5-Way Shunt Male Housing (5
Circuits)