

## Intelligent MP Series

Up to 1500 Watts

### Data Sheet

**Total Power:** Up to 1500 W  
**Input Voltage:** 85 - 264 Vac  
 120 - 300 Vdc  
**# of Outputs:** Up to 21

### SPECIAL FEATURES

- Full medical EN60601 approval
- Intelligent I<sup>2</sup>C control
- Voltage adjustment on all outputs (manual or I<sup>2</sup>C)
- Configurable input and output OK signals and indicators
- Configurable inhibit/enable
- Configurable output UP/DOWN sequencing
- Configurable current limit (foldback or constant current)
- High power density (8.8 W/cu-in)
- Intelligent fan (speed control/fault status)
- Downloadable GUI from website
- Customer provided air option
- uP controlled PFC input with active inrush protection
- I<sup>2</sup>C monitor of voltage, current, and temp
- Programmable voltage, current limit, inhibit/enable through I<sup>2</sup>C
- Optional extended hold-up module (SEMI F47 compliance)
- Increased power density to 50% over standard MP
- External switching frequency sync input
- Optional conformal coating
- Industrial temp range (-40 °C to 70 °C)
- No preload required
- Industrial shock/vibration (> 50G's)

### SAFETY

- UL UL60950/UL2601\*\*
- CSA CSA22.2 No. 234 Level 5
- UV EN60950/EN60601-1\*\*
- BABT Compliance to EN60950/EN60601 BS7002
- CB Certificate and report
- CE Mark to LVD

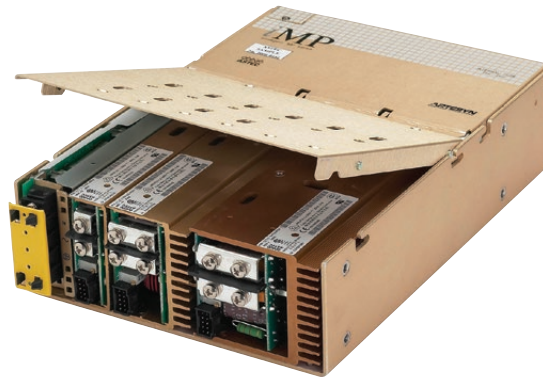

iMP™

PMBus®  
 Power Management.  
 Defined.

### Electrical Specifications

Input	
Input range	85 - 264 Vac; 120 - 300 Vdc (limited to 300 Vdc in medical applications)
Frequency	47 - 440 Hz
Inrush current	40 A peak maximum (soft start)
Efficiency	Up to 85% @ full case load
Power Factor	0.99 typ. meets EN61000-3-2 (n/a @ 440 Hz)
Turn-on time	AC on 2.0 sec typ., inhibit/enable 150 ms typical Programmable delay; 50 ms internal turn-on delay (Dual Output only)
EMI filter	CISPR 22/EN55022 Level "B"***
Leakage current	300 µA max. @ 240 Vac; 47 - 63 Hz
Radiated EMI	CISPR 22/EN55022 Level "B"***
Holdover storage	20 ms minimum (independent of input Vac) additional 34 ms holdover storage with optional HUP module (SEMI F47 compatible). For iMP4 15 ms (low-line), 10 ms (high-line)
AC OK	> 5 ms early warning min. before outputs lose regulation Full cycle ride thru (50 Hz) (n/a on iMP4 > 750 W @ 90 Vac)
Harmonic distortion	Meets EN61000-3-2
Isolation	Meets EN60950 and EN60601 Input to output, input to ground: 2000 Vac; output to ground: 400 Vdc
Global inhibit / enable	TTL, Logic "1" and Logic "0"; configurable
Input fuse (internal)	iMP4: 16 A; iMP8: 20 A; iMP1: 25 A (both lines fused)
Warranty	2 years

## Electrical Specifications

Output	
<b>Adjustment range*</b>	± 10% minimum all outputs (manual) (full module adjustment range using I <sup>2</sup> C)
Factory set point accuracy	1%
I <sup>2</sup> C output program accuracy	± 5%
Margining	± 4 - 6% nominal analog (single output module only)
Overall regulation	0.4% or 20 mV max. (1500 W modules 1% max.) (36 W modules 4% maximum)
Ripple	RMS: 0.1% or 10 mV, whichever is greater Pk-Pk: 1.0% or 50 mV, whichever is greater Bandwidth limited to 20 MHz
Dynamic response	< 2% or 100 mV, with 25% load step
Recovery time	To within 1% in < 300 µsec
<b>Overcurrent protection**</b>	Configurable through I <sup>2</sup> C (calibration required). Single output module and main output of the dual output module 105 - 120% of rated output current. Aux output of dual output module 105 - 140% of rated output current
Short-circuit protection	Protected for continuous short-circuit. Recovery is automatic upon removal of short
<b>Overvoltage protection*</b>	Configurable through I <sup>2</sup> C
	Single output module: 2 - 5.5 V 122 - 134%; 6 - 60 V 110 - 120%
	Dual output module: 2 - 6 V 122 - 134%; 8 - 28 V 110 - 120%
	Triple output module: 110 - 120% of highest voltage rating

Output (cont.)	
Reverse voltage protection	100% of rated output current
<b>Thermal protection* (OTP and OTW)</b>	Configurable through I <sup>2</sup> C All outputs disabled when internal temp exceeds safe operating range. > 5 ms warning (AC OK signal) before shutdown
Remote sense	Up to 0.5 V total drop (not available on triple output module)
Single wire parallel	Current share to within 2% of total rated current
DC OK*	± 5% of nominal. Configurable through I <sup>2</sup> C
Minimum load	Not required
Housekeeping bias voltage	5 Vdc @ 1.0 A max. present whenever AC input is applied (Optional 2.0 A available)
<b>Module inhibit*</b>	Configured and controlled through I <sup>2</sup> C
Switching frequency	250k Hz accepts external sync signal
Output/Output isolation	> 1 Megohm, 500 V
External sync	TTL clock input signal used to adjust switching frequency. Frequency 500 kHz ± 20%; Duty cycle 40 - 55%

\* Can be controlled via I<sup>2</sup>C

\*\* Controlled via I<sup>2</sup>C but requires load calibration

## Internal Part Number Reference Table

Part #	Where X =	Description	Module Code
73-580-0001i	N/A	iMP8 Case	iMP8
73-690-0001i	N/A	iMP1 Case	iMP1

## Environmental Specifications

<b>Operating temperature</b>	-40 ° to 70 °C ambient. Derate each output 2.5% per degree from 50 ° to 70 °C. (-20 °C start up)
<b>Storage temperature</b>	-40 °C to +85 °C
<b>Electromagnetic susceptibility</b>	Designed to meet EN61000-4; -2, -3, -4, -5, -6, -8, -11 Level 3
<b>Humidity</b>	Operating; non-condensing 10% to 95% RH
<b>Vibratio</b>	IEC68-2-6 to the levels of IEC721-3-2
<b>MTBF demonstrated</b>	> 550,000 hours at full load, 220 Vac and 25 °C ambient conditions

## Output Module Line-up

Module Code	1	2	3	5	4	—
Module Type	Single	Single	Single	Single	Dual	Triple
Max output power	210 W	360 W	750 W	1500 W	144 W	36 W
Max output current	35 A	60 A	150 A	140 A	10 A	2 A
Output voltages available*	2 - 60 V	2 - 60 V	2 - 60 V	6 - 60 V	8 - 15*, 24 - 28; 8 - 15*, 8 - 15*; 8 - 15*, 2 - 6; 2 - 6, 2 - 6; 24 - 28, 24 - 28; 24 - 28, 2 - 6	8-15, 8-15, 2-6; 8-15, 8-15, 8-15; 8-15, 8-15, 18-28; 8-15, 18-28, 2-6
Standard voltage increments	25	25	25	18	16	18
Remote sense	Yes	Yes	Yes	Yes	Yes	No
Remote margin	Yes	Yes	Yes	Yes	No	No
V-Program - I <sup>2</sup> C Control	Yes	Yes	Yes	Yes	Yes	No
Active Current Share	Yes	Yes	Yes	Yes	Yes	No
Module Inhibit - I <sup>2</sup> C Control	Yes	Yes	Yes	Yes	Yes	Yes
Module Inhibit - Analog	Yes	Yes	Yes	Yes	Yes	No
Overvoltage/Overcurrent protection	Yes	Yes	Yes	Yes	Yes	Yes
Minimum load required	No	No	No	No	No	No
Slots occupied in any iVS case	1	2	3	4	1	1

\* Note: Contact Factory for extended range down to 6V

## Output Module Voltage/Current\*

Voltage	Voltage Code	Single Output Module Code				Dual Output***		Triple Output			I <sup>2</sup> C Adjustment Ranges****
		1	2	3	5	4	4	-	-	-	
2 V	A	35 A	60 A	150 A	300 A	10 A	10 A	-	-	2 A	1.8 - 2.2
2.2 V	B	35 A	60 A	150 A	300 A	10 A	10 A	-	-	2 A	2.0 - 2.4
3 V	C	35 A	60 A	150 A	300 A	10 A	10 A	-	-	2 A	2.7 - 3.3
3.3 V	D	35 A	60 A	150 A	300 A	10 A	10 A	-	-	2 A	3.0 - 3.6
5 V	E	35 A	60 A	150 A	300 A	10 A	10 A	-	-	2 A	4.5 - 5.5
5.2 V	F	35 A	60 A	144 A	288 A	10 A	10 A	-	-	2 A	4.7 - 5.7
5.5 V	G	34 A	58 A	136 A	273 A	10 A	10 A	-	-	2 A	5.0 - 6.1
6.0 V	H	23 A	42 A	97.5 A	250 A	10 A*	10 A*	-	-	2 A	5.4 - 6.6
8.0 V	I	20 A	36 A	84.4 A	187.5 A	10 A	4 A	1 A	1 A	1 A	7.2 - 8.8
10 V	J	18 A	32 A	75 A	140 A	10 A	4 A	1 A	1 A	1 A	9.0 - 11.0
11 V	K	17 A	31 A	68 A	136.3 A	10 A	4 A	1 A	1 A	1 A	9.9 - 12.1
12 V	L	17 A	30 A	62.5 A	125 A	10 A	4 A	1 A	1 A	1 A	10.8 - 13.2
14 V	M	14 A	21 A	53.5 A	107 A	9 A	4 A	1 A	1 A	1 A	12.6 - 15.4
15 V	N	14 A	20 A	50 A	100 A	8 A	4 A	1 A	1 A	1 A	13.5 - 16.5
18 V	O	11 A	19 A	41.6 A	83.3 A	-	-	-	0.5 A	0.5 A	16.2 - 19.8
20 V	P	10.5 A	18 A	37.5 A	75 A	-	-	-	0.5 A	0.5 A	18.0 - 22.0
24 V	Q	8.5 A	15 A	30 A	62.5 A	4 A	2 A	-	0.5 A	0.5 A	21.6 - 26.4
28 V	R	6.7 A	11 A	26.8 A	53.5 A	3 A	2 A	-	0.5 A	0.5 A	25.2 - 30.8
30 V	S	6.5 A	11 A	25 A	50 A	-	-	-	-	-	27.0 - 33.0
33 V	T	6.2 A	10.9 A	22.7 A	35.8 A	-	-	-	-	-	29.7 - 36.3
36 V	U	5.8 A	10 A	20.8 A	35.8 A	-	-	-	-	-	32.4 - 39.6
42 V	V	4.2 A	7.5 A	16 A	35.7 A	-	-	-	-	-	37.8 - 46.2
48 V	W	4.0 A	7.5 A	15.6 A	31.2 A	-	-	-	-	-	43.2 - 52.8
54 V	X	3.7 A	6.0 A	13.9 A	27.7 A	-	-	-	-	-	48.6 - 59.4
60 V	Y	3.5 A	6.0 A	12.5 A	25 A	-	-	-	-	-	54.0 - 66.0

Contact Factory											
Special*	Z	35 A	60 A	150 A	300 A	-	10 A				2.3 - 2.6
Special*	Z	35 A	60 A	150 A	300 A	-	10 A				3.7 - 4.4
Special*	Z	20 A	36 A	80 A	140 A	-	8 A				6.7 - 7.1

\* Note: Contact Factory for extended range down to 6 V.  
 \*\* Increments of current not shown can be achieved by paralleling modules (add currents of each module selected).  
 \*\*\* Total output power on dual model must not exceed 144 W.  
 \*\*\*\* For single output modules only.  
 Green reference lines indicate physical module groupings

### Ordering Notes:

- The cases and modules of both MP and iMP series can be interchanged to allow more flexibility. If intelligent modules are used with non-intelligent cases, a numeric code "4" is placed at the end of the module code (ex. 4LL0 becomes 4LL4).
- USB to I<sup>2</sup>C module order code 73-769-001

**Parallel Codes**

Slot 7 Slot 6 Slot 5 Slot 4 Slot 3 Slot 2 Slot 1

iMP4 available slots  
iMP8 available slots  
iMP1 available slots

0 = no parallel  
1 = 1 & 2  
2 = 2 & 3  
3 = 3 & 4  
4 = 4 & 5  
5 = 3 & 4 & 5  
6 = 5 & 6  
7 = 4 & 5 & 6  
8 = 6 & 7  
9 = 3 & 4, 6 & 7  
A = 1 & 2, 3 & 4, 5 & 6  
C = 2 & 3, 4 & 5  
E = 3 & 4, 5 & 6  
F = 2 & 3, 4 & 5, 6 & 7

## Ordering Information

Case Size	Module/Voltage/Option Codes	Case Option Codes	Software Code	Hardware Code
<b>iMP1*</b>	<b>3L0 - 2E2 - 1Q1 - 4LL0</b>	<b>00</b>	<b>A</b>	<b>###</b>
<p><b>Case Size (mm)</b>                      4 = 2.5" x 5" x 10"; 750 W - 1158 W, 5 Slots (63.5 x 127 x 254 mm)                      8 = 2.5" x 7" x 10"; 1000 W - 1200 W, 6 Slots (63.5 x 177.8 x 254 mm)                      1 = 2.5" x 8" x 11"; 1200 W - 1500 W, 7 Slots (63.5 x 203.2 x 279.4 mm)</p>	<p><b>Module Codes</b>                      Module/voltage/option codes                      Module codes:                      (None) = 36 W triple O/P (1 slot)                      1 = 210 W single O/P (1 slot)                      2 = 360 W single O/P (2 slot)                      3 = 750 W single O/P (3 slot)                      4 = 144 W dual O/P (1 slot)                      5 = 1500 W single O/P (4 slot)                      6 - 9 = future  <b>Voltage Codes:</b>                      See Output Module Voltage/Current table above  <b>Option Codes:</b>                      0 = Standard                      1 = Module enable                      2 = Constant current                      3 = 1 &amp; 2 combined                      4 = Set for use in standard (non-intelligent case)                      5 = Shutdown mode for 1500 W                      6 = 1 &amp; 5 combined                      7 - 9 = future</p>	<p><b>Case Option Codes</b>                      First digit                      0 - 9, A - Z parallel code (See Parallel Codes table above)                      Second digit                      0 = No options                      1 = Reverse air                      3 = Global enable                      4 = Fan idle with inhibit                      5 = Opt 1 + Opt 3                      6 = Opt 1 + Opt 4                      7 = Opt 3 + Opt 4                      8 = Opt 1 + 3 + 4                      9 = RS485 73-544-002                      A = RS485 73-544-002 + Reverse air                      C = Opt 3 + Opt 9                      D = CAN BUS 73-544-003                      E = Opt 3 + Opt D</p>	<p>Software code used for configuration change. "A" is standard</p>	<p>Factory assembled for hardware of firmware mods.</p>

\* Note: Add "E" after iMP4 to denote IEC input option. e.g. iMP4E (Not available on iMP8 or iMP1)

## Single

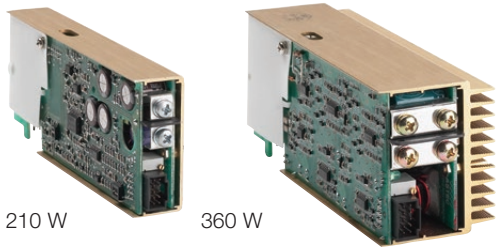

210 W

360 W

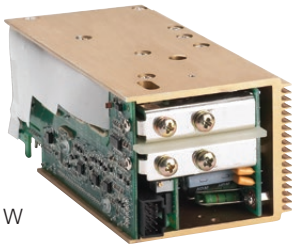

750 W

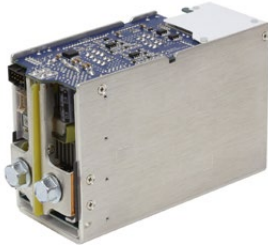

1500 W ( 2.0 - 8.0 V)



1500 W ( 10 - 60 V)

1500 W with Bus Bar Adapter Option (used with the 10 - 60 V module)



## Dual



144 W

## Triple



36 W

## iMP4 (AC input on opposite side)

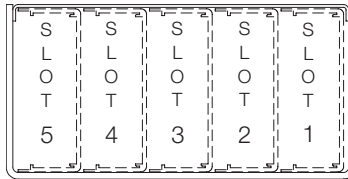

iMP4 = 2.5" x 5" x 10" 5 available slots (63.5 x 127 x 254 mm)

Input  
 90 - 264 Vac 750 W max.  
 180 - 264 Vac 1158 W max.

## iMP8 and iMP1

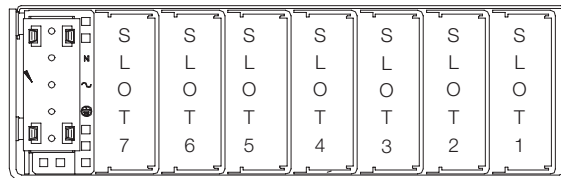

iMP8 = 2.5" x 7" x 10" 6 available slots (63.5 x 177.8 x 254 mm)  
 iMP1 = 2.5" x 8" x 11" 7 available slots (63.5 x 203.2 x 279.4 mm)

Input  
 85 - 264 Vac 1000 W max.  
 180 - 264 Vac 1200 W max.

1200 W max. 1500 W max.

## Pin Connectors

Figure 1. AC Input

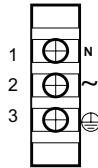
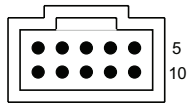

Figure 2. Connector J1



Mates with  
 Molex 90142-0010 Housing  
 90119-2110 Pin

Connector Kit Part No.:  
 70-841-004

Figure 3. Connector J2



Mates with  
 Landwin 2050S1000 Housing  
 2053T011V Pin

or  
 JST PHDR-10VS Housing  
 JST SPHD-002T-P0.5 (28-24)  
 JST SPHD-001T-P0.5 (26-22)

Connector Kit Part No.:  
 70-841-023

AC Input	
Pin No.	Function
1	AC neutral
2	AC line (hot)
3	Chassis (earth) ground
PFC Input Connector (control and signals)	
Pin No.	Function
1	Input AC OK - "emitter"
2	Input AC OK - "collector"
3	Global DC OK - "emitter"
4	Global DC OK - "collector"
5	External Sync
6	Global inhibit/optional enable logic "0"
7	Global inhibit/optional enable logic "1"
8	Global inhibit/optional enable return
9	+5 VSB housekeeping
10	+5 VSB housekeeping return
I <sup>2</sup> C Bus Output Connector	
Pin No.	Function
1	No connection
2	No connection
3	No connection
4	Serial clock signal (SCL)
5	Serial data signal (SDA)
6	Address bit 0 (A0)
7	Address bit 1 (A1)
8	Address bit 2 (A2)
9	Secondary return (GND)
10	5 Vcc external bus (5 VCC. Bus)

## Mechanical Drawings

### iMP Modules

#### DC-DC Converter Output Modules

Control Signal Information, J1 Control Connector

Pin No.	Function	
1	+ Remote Sense	single or dual o/p main
2	Remote Margin / V. Program	single o/p
3	Margin High	single o/p
4	- Remote Sense / Margin Low	single or dual o/p main
5	Spare	
6	Module, Isolated Inhibit	single or dual o/p
7	Module Inhibit Return	single or dual o/p
8	Current Share (SWP)	single or dual o/p main
9	+ Remote Sense V2	dual o/p, single is spare
10	- Remote Sense V2	dual o/p, single is spare

\* Note: All iMP modules have a green DCOK LED. (except for 36 W module)

Figure 4. Connector J1

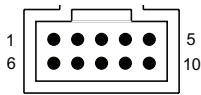

Mates with  
Molex 90142-0010 Housing  
90119-2110 Pin

#### Single 210 Watt

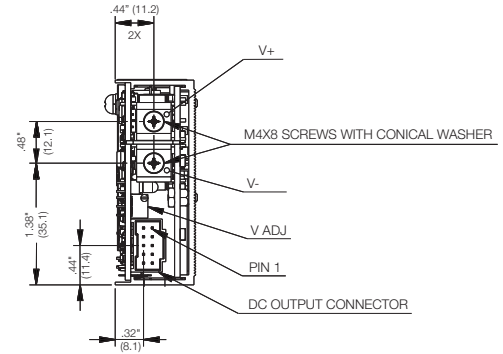

#### Single 360 Watt

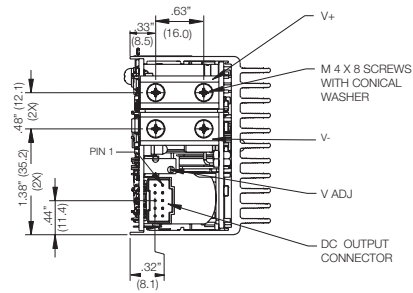

#### Single 750 Watt

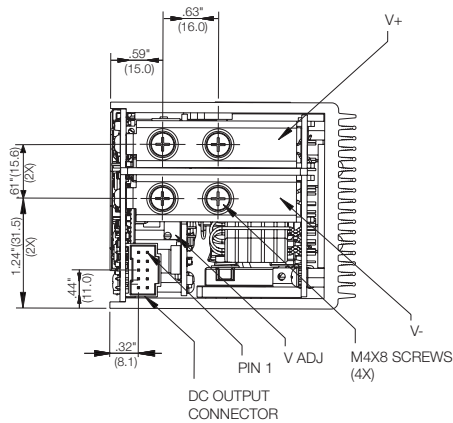

#### Single 1500 Watt 2-8 V

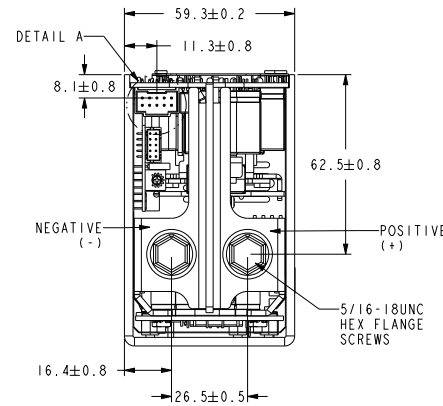

#### Single 1500 Watt 10-60 V

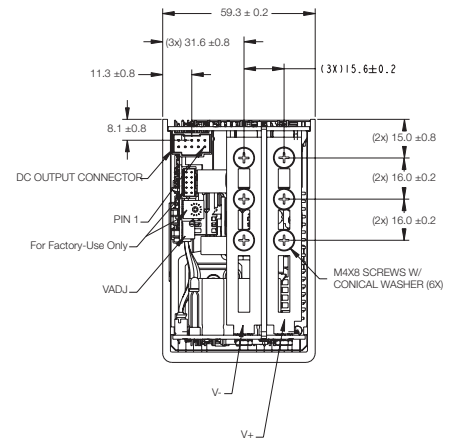

#### Dual 144 Watt

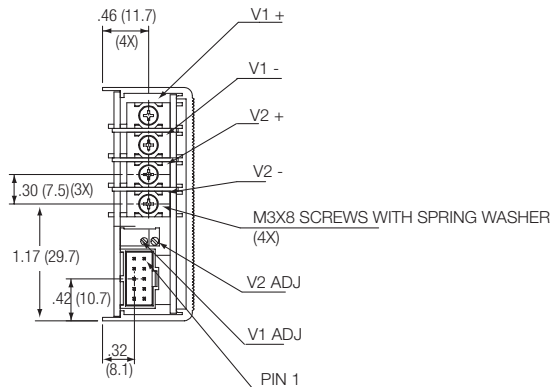

#### Triple 36 Watt

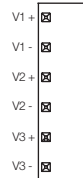
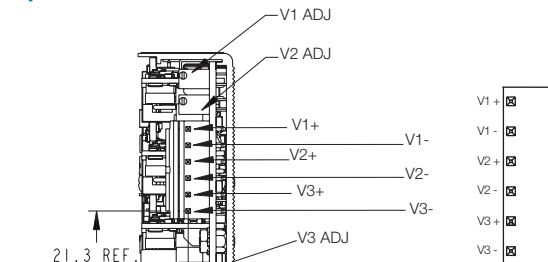

Mates with  
Molex 09-91-0600 Housing  
26-60-5060 Pin

iMP Series

iMP4 (750/1158 Watts Max)

5-Inch Case Size: iMP4: 2.5" x 5" x 10" (63.5 mm x 127 mm x 254 mm)

Weight: iMP4 Case: 3 lbs. • 360 W Single 1.0 lb. • 750 W Single: 1.6 lbs. 144 W Dual: 0.6 lb.

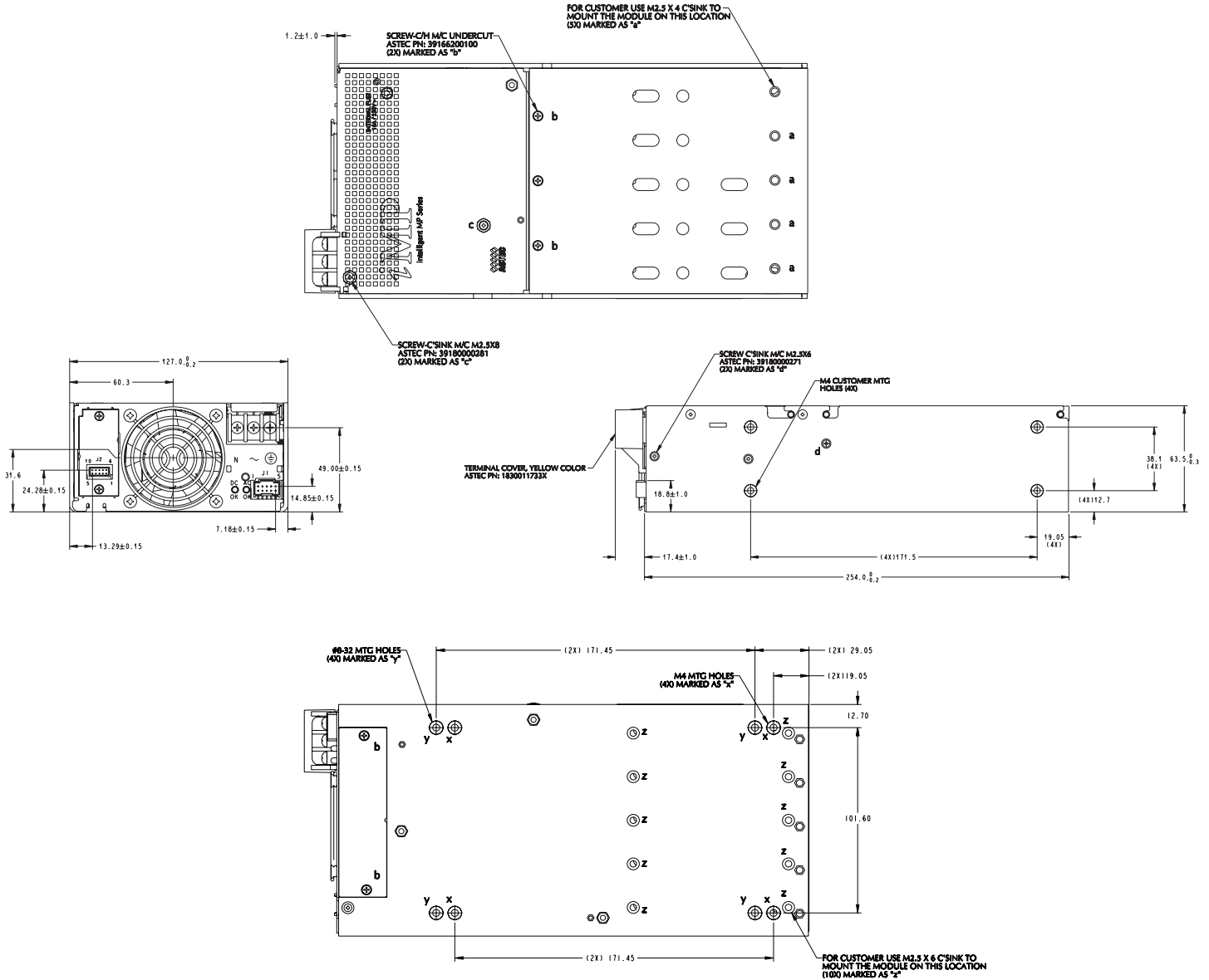

Notes:

- Input: Barrier type. Three No. 6-32 B.H. screws (0.375" centers). Max torque: 6 in-lbs. (0.67 N-m). (Optional IEC input connector)
- Control connectors: (J1) 10 position housing, gold plated contacts. Mates with Molex 90142-0010 housing with 90119-2110 crimp contacts (Molex C - Grid III Series). Connector kit includes mating connector and 10 pins, Astec part #70-841-004. (J2) 10 position housing (Landwin 2051P1000T). Mates with housing 2050S1000 (Landwin) with 2053T011P (Landwin) pins or JST PHDR-IOVS Housing and JST SPHD-002T-PO.5 pins.
- Chassis material: aluminum with chemical film coating (conductive).
- All dimensions are in millimeters and inches, and are typical.
- Customer mounting -3 sides M4, bottom also includes 8-32 mounting holes. Max. penetration is 0.150" (3.8 mm). Max. torque: 5 in-lbs. (0.57 N-m).
- Output module connections: All single O/P modules are M4 x 8 mm screws. Max. torque: 10 in-lbs. (1.13 N-m). Dual O/P module is M3 x 8 mm screws. Max. torque: 5 in-lbs. (0.57 N-m).

iMP Series

iMP8 (1000/1200 Watts Max)

7-Inch Case Size: iMP8: 2.5" x 7" x 10" (63.5 mm x 177.8 mm x 254 mm)  
 Weight: iMP8 Case: 4.1 lbs. • 210 W Single: 0.6 lb. • 360 W Single: 1.0 lb.  
 • 750 W Single: 1.6 lbs. 144 W Dual: 0.6 lb.

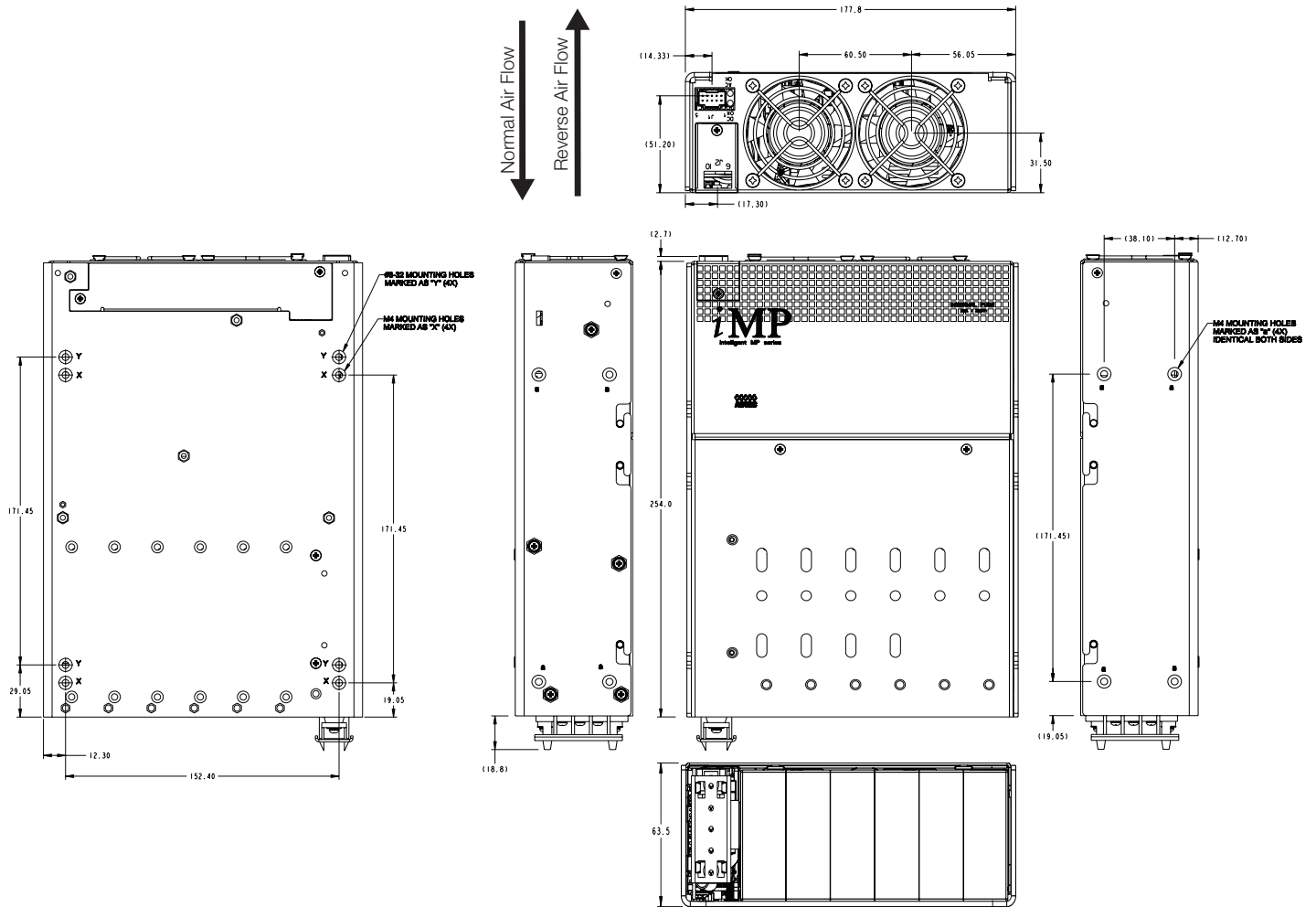

Notes:

1. Input: Barrier type. Three No. 6-32 B.H. screws (0.375" centers). Max torque: 6 in-lbs. (0.67 N-m).
2. Control connectors: (J1) 10 position housing, gold plated contacts. Mates with Molex 90142-0010 housing with 90119-2110 crimp contacts (Molex C - Grid III Series) Connector kit includes mating connector and 10 pins, Astec part #70-841-004. (J2) 10 position housing (Landwin 2051P1000T). Mates with housing 2050S1000 (Landwin) with 2053T011P (Landwin) pins or JST PHDR-IOVS Housing and JST SPHD-002T-PO.5 pins.
3. Chassis material: aluminum with chemical film coating (conductive).
4. All dimensions are in millimeters and inches, and are typical.
5. Customer mounting -3 sides M4, bottom also includes 8-32 mounting holes. Max. penetration is 0.150" (3.8 mm). Max. torque: 5 in-lbs. (0.57 N-m).
6. Output module connections: All single O/P modules are M4 x 8 mm screws. Max. torque: 10 in-lbs. (1.13 N-m). Dual O/P module is M3 x 8 mm screws. Max. torque: 5 in-lbs. (0.57 N-m).

iMP Series

iMP1 (1200/1500 Watts Max)

8-Inch Case Size: iMP1: 2.5" x 8" x 11" (63.5 mm x 203.2 mm x 279.4 mm)

Weight: iMP1 Case: 5.0 lb. • 210 W Single: 0.6 lb. • 360 W Single: 1.0 lb.

• 750 W Single: 1.6 lb. • 144 W Dual: 0.6 lb.

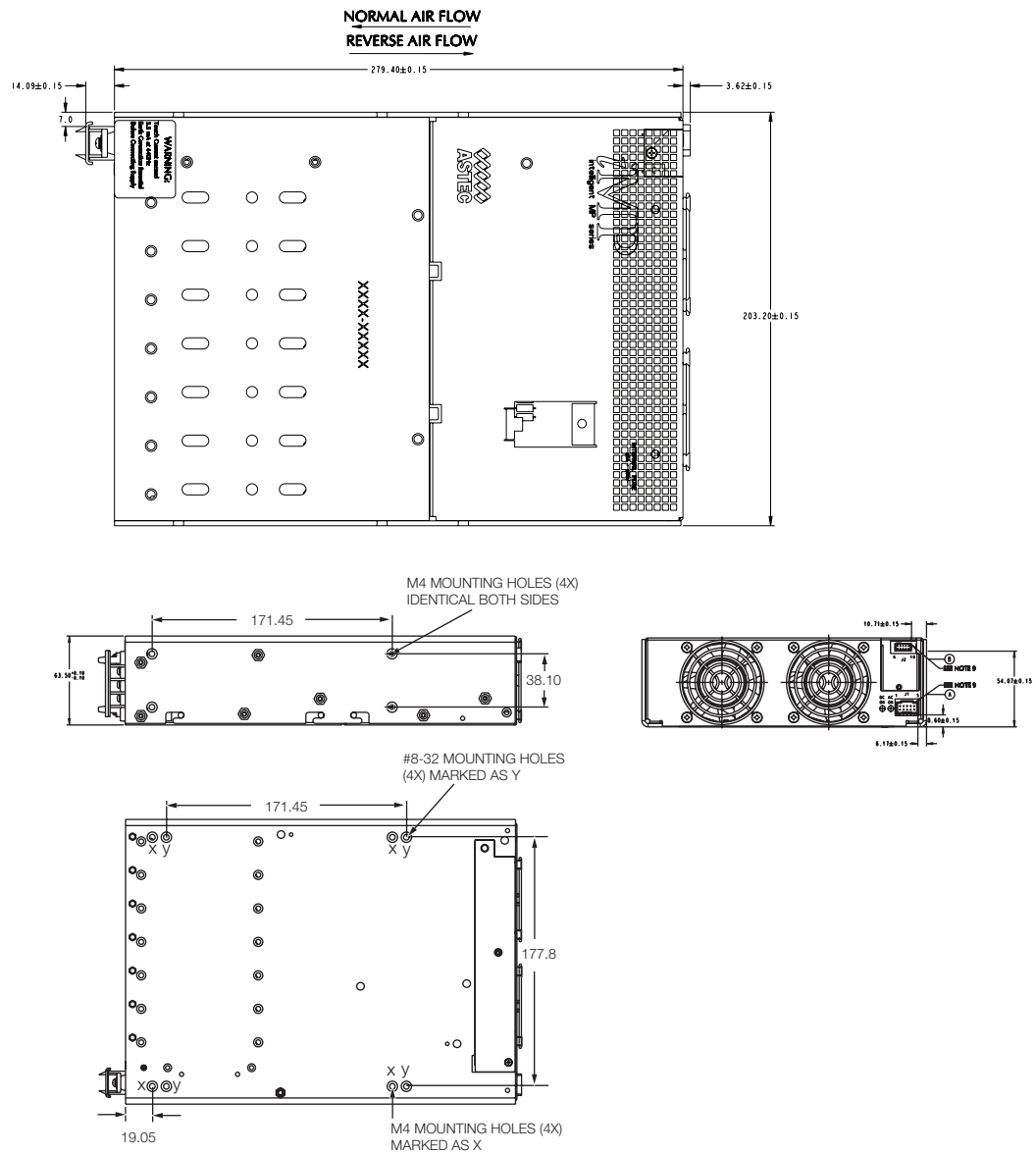

Notes:

1. Input: Barrier type. Three No. 6-32 B.H. screws (0.375" centers). Max torque: 6 in-lbs (0.67 N-m).
2. Control connectors: (J1) 10 position housing, gold plated contacts. Mates with Molex 90142-0010 housing with 90119-2110 crimp contacts (Molex C - Grid III Series). Connector kit includes mating connector and 10 pins, Astec part #70-841-004. (J2) 10 position housing (Landwin 2051P1000T). Mates with housing 2050S1000 (Landwin) with 2053T011P (Landwin) pins or JST PHDR-IOVS Housing and JST SPHD-002T-PO.5 pins.
3. Chassis material: aluminum with chemical film coating (conductive).
4. All dimensions are in millimeters and inches, and are typical.
5. Customer mounting -3 sides M4, bottom also includes 8-32 mounting holes. Max. penetration is 0.150" (3.8 mm). Max. torque: 5 in-lbs. (0.57 N-m).
6. Output module connections: All single O/P modules are M4 x 8 mm screws. Max. torque: 10 in-lbs. (1.13 N-m). Dual O/P module is M3 x 8 mm screws. Max. torque: 5 in-lbs. (0.57 N-m).



## Optional CANBUS or RS485 Interface

The RS485/CAN-to-I<sup>2</sup>C uses 2 Input Protocols and 1 Output Protocol.

The Input Protocols used are RS485 using Modbus (Command Index: 0x01), and CAN using modified Modbus (Command Index: 0x02).

The Output Protocol use is: I<sup>2</sup>C with SMBus support (Command Index: 0x80).

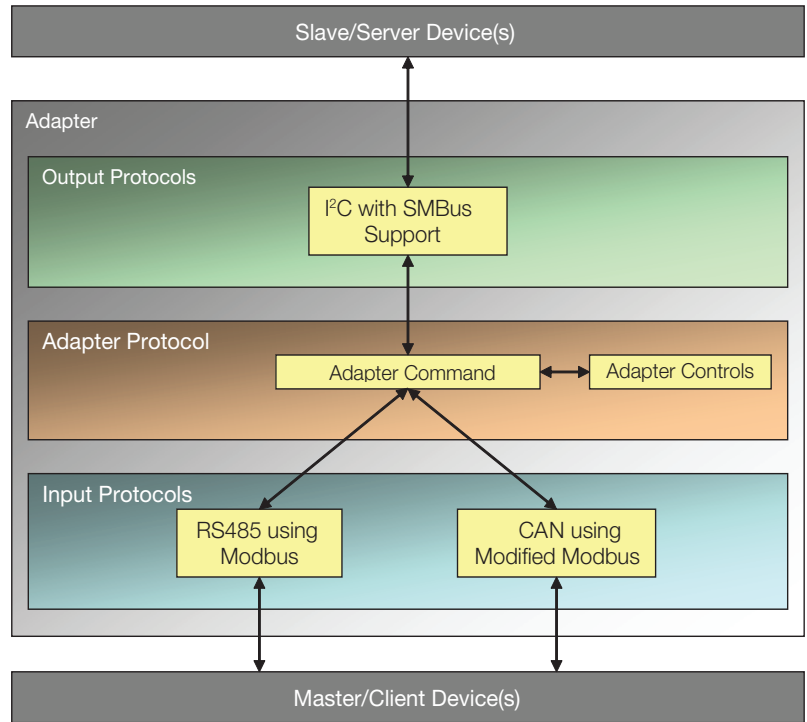

iMP CAN RS485

### RS485/CAN - to - I<sup>2</sup>C

For detailed info, download the Software Requirements Specification (SRS) from <http://www.artesyn.com/power/power-supplies/cat/101/Configurable-Power-Supplies-iMP-Series>

## WORLDWIDE OFFICES

### Americas

2900 S.Diablo Way  
Tempe, AZ 85282  
USA  
+1 888 412 7832

### Europe (UK)

Waterfront Business Park  
Merry Hill, Dudley  
West Midlands, DY5 1LX  
United Kingdom  
+44 (0) 1384 842 211

### Asia (HK)

14/F, Lu Plaza  
2 Wing Yip Street  
Kwun Tong, Kowloon  
Hong Kong  
+852 2176 3333

**ARTESYN**  
EMBEDDED TECHNOLOGIES

[www.artesyn.com](http://www.artesyn.com)