

MODEL PXU - TEMPERATURE/PROCESS CONTROLLERS



- PID CONTROL
- ACCEPTS TC and RTD
- ACCEPTS 0-10 V, 0/4-20 mA or 0-50 mV SIGNALS
- FUNCTIONS AS A DIGITAL POT
- ON DEMAND AUTO-TUNING OF PID SETTINGS
- DC ANALOG CONTROL OUTPUT (OPTIONAL)
- 2 USER PROGRAMMABLE FUNCTION BUTTONS
- PC (MODELS WITH RS 485) OR FRONT PANEL PROGRAMMING
- 1/16, 1/8 or 1/4 DIN
- CONTROLLERS MEET IP65 REQUIREMENTS



GENERAL DESCRIPTION

The PXU controller accepts signals from a variety of temperature sensors including thermocouple or RTD. The controller can also be configured for process inputs including 0 to 5/10 VDC, 0/4 to 20 mA DC, or 0 to 50 mV DC. The PXU can provide an accurate output control signal (time proportional or DC Analog Output) to maintain a process at a determined setpoint value. Dual 4-digit display readings allow viewing of the temperature/process and setpoint value simultaneously. Front panel indicators inform the operator of alarm and control output status. Comprehensive programming features allow this controller to meet a wide variety of application requirements.

MAIN CONTROL

The PXU allows the user to select between PID, On/Off and Manual control mode. The PXU has the ability to provide 2 control outputs. The control outputs can be individually configured for Reverse or Direct (heating or cooling) applications. The PID tuning constants can be established via on-demand auto-tune. The PID constants can also be programmed, or fine-tuned, through the front panel or a PC and then locked out from further modification.

ALARMS

Alarm(s) can be configured independently for absolute high or low acting with balanced or unbalanced hysteresis. They can also be configured for deviation and band alarm. In these modes, the alarm trigger values track the setpoint value. Adjustable alarm hysteresis can be used for delaying output response. The alarms can be programmed for Automatic or Latching operation. A selectable standby feature suppresses the alarm during power-up until the temperature stabilizes outside the alarm region.

CONSTRUCTION

The PXU is constructed of a lightweight, high impact, black plastic textured case with a clear display window. Modern surface-mount technology, extensive testing, plus high immunity to noise interference makes the controller extremely reliable in industrial environments.

SAFETY SUMMARY

All safety related regulations, local codes and instructions that appear in the manual or on equipment must be observed to ensure personal safety and to prevent damage to either the instrument or equipment connected to it. If equipment is used in a manner not specified by the manufacturer, the protection provided by the equipment may be impaired.

Do not use this unit to directly command motors, valves, or other actuators not equipped with safeguards. To do so can be potentially harmful to persons or equipment in the event of a fault to the controller. If redundant safeguards are not in place, an independent and redundant temperature limit indicator with alarm outputs is strongly recommended.



CAUTION: Risk of Danger.
 Read complete instructions prior to installation and operation of the unit.



CAUTION: Risk of electric shock.
 When the power is on, DO NOT touch the AC terminals, an electric shock may occur. Make sure the power is disconnected when you check the input power supply.

1. Prevent dust or metallic debris from falling into the controller and causing malfunctions. DO NOT modify the controller.
2. The PXU is an open-type device. Make sure it is installed in an enclosure free of dust and humidity in case of an electric shock.
3. Wait for one minute after the power is switched off to allow the unit to discharge. DO NOT touch the internal wiring within this period of time.

DIMENSIONS In inches (mm) - 1/16 DIN

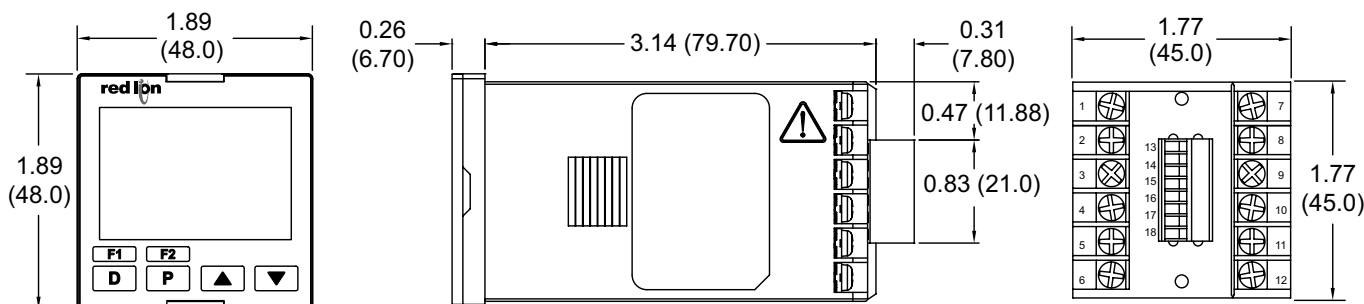

DIMENSIONS In inches (mm) - 1/8 DIN

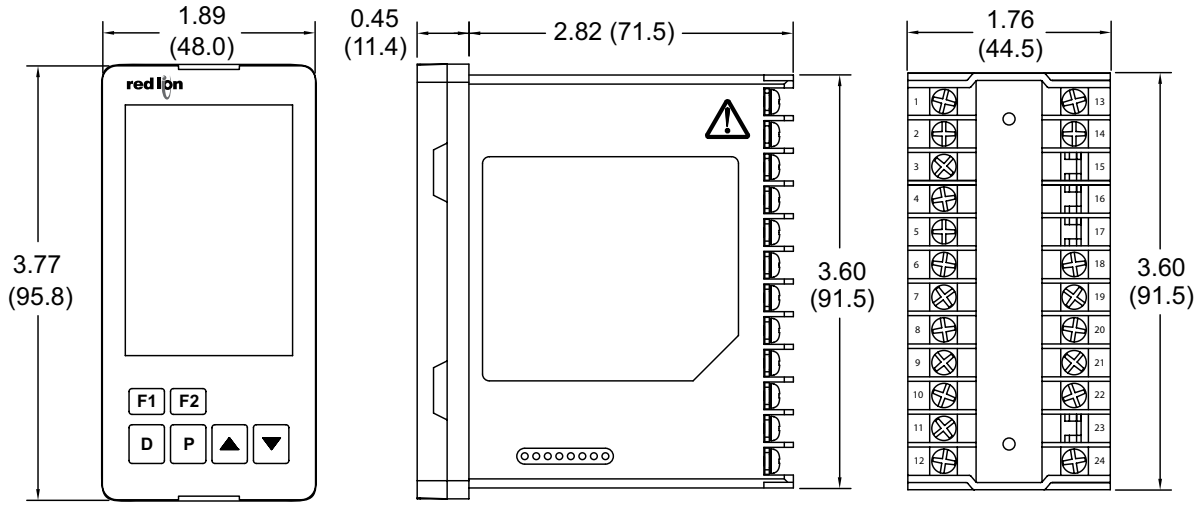

DIMENSIONS In inches (mm) - 1/4 DIN

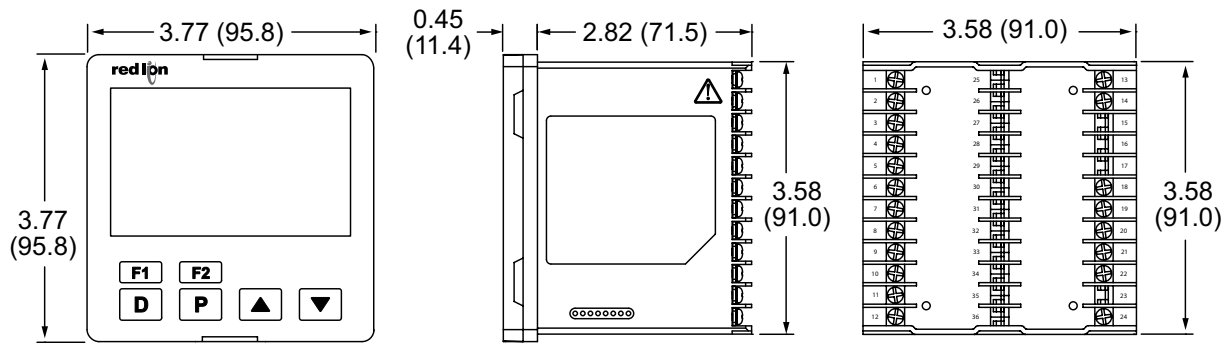

TABLE OF CONTENTS

General Specifications	3	Programming Loops	8
Ordering Information	4	Troubleshooting	21
EMC Installation Guidelines	5	Control Mode Explanations	22
Setting the Current Input Jumper	5	PID Tuning Explanations	23
Installing the Controller	6	Parameter Value Chart	25
Wiring the Controller	7	Programming Overview	26
Reviewing the Front Keys and Display	8		

GENERAL SPECIFICATIONS

- DISPLAY:** LCD negative image transmissive with backlighting. Top (process) display with orange backlighting, bottom (parameter) display with green backlighting.

Line 1 and 2: 4 digits each line

Status Annunciators:

- OUT1 - Control output 1 is active.
- OUT2 - Control output 2 is active.
- ALM1 - Alarm 1 output is active.
- ALM2 - Alarm 2 output is active.
- ALM3 - Alarm 3 output is active.
- °F, °C - Temperature units.
- MAN - Controller is in Manual Mode.
- AT - Auto-Tune active.

1/4 DIN Model Digit Size: Line 1 - 0.87" (22 mm); Line 2 - 0.55" (14 mm)

1/8 DIN Model Digit Size: Line 1 - 0.47" (12 mm); Line 2 - 0.47" (12 mm)

1/16 DIN Model Digit Size: Line 1 - 0.43" (11 mm); Line 2 - 0.27" (7.0 mm)

- POWER:**

Line Voltage Models:

100 to 240 VAC -20/+8 %, 50/60 Hz, 5 VA

Low Voltage Models:

DC Power: 24 VDC, ±10%, 5 W

- KEYPAD:** Mylar overlay with 4 program/selection keys and 2 user programmable function keys. 6 keys total.

- Display Messages:**

- UL UL** - Measurement exceeds + sensor range
- LL LL** - Measurement exceeds - sensor range
- OPEN** - Open sensor is detected (TC or RTD)
- SHRT** - Shorted sensor is detected (RTD only)
- . . . - Display value exceeds + display range
- . . - Display value exceeds - display range

- SENSOR INPUT:**

Sample Period: 100 msec (10 Hz rate)

A/D Converter: 16 bit resolution

Span Drift (maximum): 130 PPM/°C

Input Fail Response:

Main Control Output(s): Programmable preset output

Display: **OPEN**, **SHRT**

Alarms: programmable for On or Off

Normal Mode Rejection: >35 dB @ 50/60 Hz

Common Mode Rejection: >120 dB, DC to 60 Hz

- INPUT CAPABILITIES:**

Temperature/RTD Indication Accuracy:

± (0.3% of span, +1°C) at 25°C ambient after 20 minute warm up. Includes NIST conformity, cold junction effect, A/D conversion errors and linearization conformity.

THERMOCOUPLE INPUTS:

Types: T, E, J, K, R, S, B, N, L, U, and TXK

Input Impedance: Approximately 4.7 MΩ

Lead Resistance Effect: -0.3 μV/Ω

Cold Junction Compensation: Less than ±1.5°C typical (2.5°C max) error over 0 to 50°C temperature range.

Resolution: 1° for types R, S, B and 1° or 0.1° for all other types

TYPE	DISPLAY RANGE	WIRE COLOR		STANDARD
		ANSI	BS 1843	
T	-200 to +400°C -328 to +752°F	(+) Blue (-) Red	(+) White (-) Blue	ITS-90
E	0 to 600°C +32 to +1112°F	(+) Violet (-) Red	(+) Brown (-) Blue	ITS-90
J	-100 to +1200°C -148 to +2192°F	(+) White (-) Red	(+) Yellow (-) Blue	ITS-90
K	-200 to +1300°C -328 to +2372°F	(+) Yellow (-) Red	(+) Brown (-) Blue	ITS-90
R	0 to +1700°C +32 to +3092°F	No standard	(+) White (-) Blue	ITS-90
S	0 to +1700°C +32 to +3092°F	No standard	(+) White (-) Blue	ITS-90
B	+100 to +1800°C +212 to +3272°F	No standard	No standard	ITS-90
N	-200 to +1300°C -328 to +2372°F	(+) Orange (-) Red	(+) Orange (-) Blue	ITS-90
L	-200 to +850°C -328 to +1562°F	(+) Red (-) Blue	(+) Red (-) Blue	DIN 43714
U	-200 to +500°C -328 to +932°F	No standard	(+) White (-) Blue	IPTS68
TXK	-200 to +800°C -328 to +1472°F	—	—	—

RTD INPUTS:

Type: 2 or 3 wire

Excitation: 180 μA typical

Resolution: 1° or 0.1° for all types

TYPE	INPUT TYPE	RANGE	STANDARD
385	100 Ω platinum, Alpha = .00385	-200 to +850°C -328 to +1562°F	IEC 751
392	100 Ω platinum, Alpha = .003919	-20 to +400°C -32 to +752°F	No official standard
672	120 Ω Nickel alpha = .00672	-80 to +300°C -112 to +572°F	
Cu50	50 Ω Copper alpha = .00428	-50 to +150°C -58 to +302°F	

PROCESS INPUTS:

INPUT RANGE	ACCURACY *	IMPEDANCE	MAX CONTINUOUS OVERLOAD	RESOLUTION
0-5 VDC	0.3% of rdg + 0.03 V	1.8 MΩ	50 V	395 μV
0-10 VDC	0.3% of rdg + 0.03 V	1.8 MΩ	50 V	395 μV
0-20 mA	0.3% of rdg + 0.04 mA	249 Ω	30 mA	1.6 μA
4-20 mA	0.3% of rdg + 0.04 mA	249 Ω	30 mA	1.6 μA
0-50 mV	0.3% of rdg + 0.1 mV	4.7 MΩ	30 V	2.2 μV

*Accuracies are expressed as ± percentages @ 25 °C ambient range after 20 minute warm-up.

- USER INPUT:** (Optional)

Contact Input: ON Resistance 1 KΩ max.

OFF Resistance 100 KΩ min.

Response Time: 1 sec max

Functions: Programmable

- MEMORY:** Nonvolatile E²PROM retains all programmable parameters.

- OUTPUT CAPABILITIES:**

Output: Time proportioning or DC Analog

Control: PID, On/Off or user/manual

Cycle Time: Programmable

Auto-Tune: When selected, sets proportional band, integral time, derivative time, and integration default. Also sets relative gain (if applicable).

Input Fail Action: Programmable output power level

CONTROL RELAY OUTPUTS (OUT1/OUT2):

Type: Form A

Contact Rating: 5 A @ 250 VAC

Life Expectancy: 100,000 cycles at max. load rating

(Decreasing load and/or increasing cycle time, increases life expectancy)

CONTROL SSR DRIVE OUTPUT (OUT1):

Rating: 12 VDC ± 10% @ 40 mA max.

CONTROL ANALOG OUTPUT (OUT1):

Output: Time proportioning or DC Analog

Analog Types: 4 to 20 mA or 0 to 10 VDC

Isolation To Sensor & Communication Common: 500 VDC for 1 min.

Resolution: 12 bit

Compliance: 10 VDC: 1 KΩ load min., 20 mA: 500 Ω load max.

ALARMS: 2 relay alarm outputs.

Type: Form A or Form C, model and alarm dependent

Contact Rating: 3 A @ 250 VAC

Life Expectancy: 100,000 cycles at max. load rating

(Decreasing load and/or increasing cycle time, increases life expectancy)

Modes:

None

Absolute High Acting (Balanced or Unbalanced Hysteresis)

Absolute Low Acting (Balanced or Unbalanced Hysteresis)

Deviation High Acting

Deviation Low Acting

Inside Band Acting

Outside Band Acting

Reset Action: Programmable; automatic or latched

Standby Mode: Programmable; yes or no

Hysteresis: Programmable

Input Fail Response: Programmable

Annunciator: "ALM1", "ALM2", and "ALM3", programmable for normal or reverse acting

10. ISOLATION LEVEL:

AC power with respect to all other I/O: 250 V working (2300 V for 1 min.)
Sensor input to analog output: 50 V working (500 V for 1 minute)
Relay contacts to all other I/O: 250 V working (2300 V for 1 minute)
DC power with respect to sensor input and analog output: 50 V working (500 V for 1 minute)

11. CERTIFICATIONS AND COMPLIANCES:

CE Approved

EN 61326-1 Immunity to Industrial Locations
 Emission CISPR 11 Class A
 EN 61010-1
 RoHS Compliant

UL Listed: File #E179259

IP65 Enclosure rating (Face only)

Refer to EMC Installation Guidelines section of the bulletin for additional information.

12. ENVIRONMENTAL CONDITIONS:

Operating Temperature Range: 0 to 50°C

Storage Temperature Range: -20 to 65°C

Operating and Storage Humidity: 80% max relative humidity (non-condensing) from 0°C to 50°C

Vibration Resistance: Operational 10 to 55 Hz, 1 g

Shock Resistance: Operational 30 g

Altitude: Up to 2000 meters

13. **CONNECTION:** Wire-clamping screw terminals

14. **CONSTRUCTION:** Black plastic alloy case and panel latch. Black plastic textured bezel with transparent display window. Controller meets IP65 requirements for indoor use when properly installed. Installation Category II, Pollution Degree 2.

15. **WEIGHT:**

1/4 DIN: 11.0 oz (312 g)

1/8 DIN: 7.8 oz (221 g)

1/16 DIN: 5.3 oz (150 g)

ORDERING INFORMATION

MODEL NO.	DIN SIZE	MAIN CONTROL OUTPUT 1	SECONDARY CONTROL OUTPUT 2	USER INPUT(S)	RS 485	PART NUMBERS		
						100 to 240 VAC	24 VDC	
PXU	1/16	Relay	-	-	-	PXU10020	PXU100B0	
		Relay	Relay	2	Yes	PXU11A20	PXU11AB0	
		Logic/SSR	-	-	-	PXU20020	PXU200B0	
		Logic/SSR	Relay	2	Yes	PXU21A20	PXU21AB0	
		4-20 mA	-	-	-	PXU30020	PXU300B0	
		4-20 mA	Relay	2	Yes	PXU31A20	PXU31AB0	
		0-10 VDC	-	-	-	PXU40020	PXU400B0	
	0-10 VDC	Relay	2	Yes	PXU41A20	N/A		
	1/8 (vertical)	Relay	-	-	-	PXU10030	PXU100C0	
		Relay	Relay	2	Yes	PXU11A30	PXU11AC0	
		Logic/SSR	-	-	-	PXU20030	PXU200C0	
		Logic/SSR	Relay	2	Yes	PXU21A30	PXU21AC0	
		4-20 mA	Relay	2	Yes	PXU31A30	PXU31AC0	
	1/4	0-10 VDC	-	-	-	PXU40030	PXU400C0	
		Relay	Relay	2	Yes	PXU11A50	PXU11AE0	
		4-20 mA	Relay	2	Yes	PXU31A50	PXU31AE0	
			0-10 VDC	Relay	2	Yes	PXU41A50	PXU41AE0

Only stocked part numbers are listed. Contact factory for availability of non-stock models.
 In order to program the unit using Crimson, the unit must be purchased with the RS 485 option.

ACCESSORIES

MODEL NO.	DESCRIPTION	PART NUMBERS
RLY	External SSR Power Unit (for Logic/SSR models)	RLY50000
	25 A Single Phase Din Rail Mount Solid State Relay	RLY60000
	40 A Single Phase Din Rail Mount Solid State Relay	RLY6A000
	Three Phase Din Rail Mount Solid State Relay	RLY70000
PGUSB	USB to 485 Converter with Cable	PGUSB485
SFCRD ¹	Crimson PC Configuration Software	SFCRD200

¹ Crimson software is a free download from <http://www.redlion.net>



Do not dispose of unit in trash - Recycle

EMC INSTALLATION GUIDELINES

Although Red Lion Controls Products are designed with a high degree of immunity to Electromagnetic Interference (EMI), proper installation and wiring methods must be followed to ensure compatibility in each application. The type of the electrical noise, source or coupling method into a unit may be different for various installations. Cable length, routing, and shield termination are very important and can mean the difference between a successful or troublesome installation. Listed are some EMI guidelines for a successful installation in an industrial environment.

1. A unit should be mounted in a metal enclosure, which is properly connected to protective earth.
2. Use shielded cables for all Signal and Control inputs. The shield connection should be made as short as possible. The connection point for the shield depends somewhat upon the application. Listed below are the recommended methods of connecting the shield, in order of their effectiveness.
 - a. Connect the shield to earth ground (protective earth) at one end where the unit is mounted.
 - b. Connect the shield to earth ground at both ends of the cable, usually when the noise source frequency is over 1 MHz.
3. Never run Signal or Control cables in the same conduit or raceway with AC power lines, conductors, feeding motors, solenoids, SCR controls, and heaters, etc. The cables should be run through metal conduit that is properly grounded. This is especially useful in applications where cable runs are long and portable two-way radios are used in close proximity or if the installation is near a commercial radio transmitter. Also, Signal or Control cables within an enclosure should be routed as far away as possible from contactors, control relays, transformers, and other noisy components.
4. Long cable runs are more susceptible to EMI pickup than short cable runs.
5. In extremely high EMI environments, the use of external EMI suppression devices such as Ferrite Suppression Cores for signal and control cables is

effective. The following EMI suppression devices (or equivalent) are recommended:

Fair-Rite part number 0443167251 (RLC part number FCOR0000)

Line Filters for input power cables:

Schaffner # FN2010-1/07 (Red Lion Controls # LFIL0000)

6. To protect relay contacts that control inductive loads and to minimize radiated and conducted noise (EMI), some type of contact protection network is normally installed across the load, the contacts or both. The most effective location is across the load.
 - a. Using a snubber, which is a resistor-capacitor (RC) network or metal oxide varistor (MOV) across an AC inductive load is very effective at reducing EMI and increasing relay contact life.
 - b. If a DC inductive load (such as a DC relay coil) is controlled by a transistor switch, care must be taken not to exceed the breakdown voltage of the transistor when the load is switched. One of the most effective ways is to place a diode across the inductive load. Most RLC products with solid state outputs have internal zener diode protection. However external diode protection at the load is always a good design practice to limit EMI. Although the use of a snubber or varistor could be used.
RLC part numbers: Snubber: SNUB0000
Varistor: ILS11500 or ILS23000
7. Care should be taken when connecting input and output devices to the instrument. When a separate input and output common is provided, they should not be mixed. Therefore a sensor common should NOT be connected to an output common. This would cause EMI on the sensitive input common, which could affect the instrument's operation.

Visit RLC's web site at <http://www.redlion.net/emi> for more information on EMI guidelines, Safety and CE issues as they relate to Red Lion Controls products.

1.0 SETTING THE CURRENT INPUT JUMPER

When Input Type is selected as one of the two current input types (0-20 or 4-20), the current input jumper must be installed. The current input jumper is factory set for Temperature and Voltage input types. To change the jumper to configure the input for a current input type, the inside of the unit must be accessed and the jumper position changed.

To access the jumper, locate the two latches located on top and bottom of the front of the unit. Starting with the top latch, insert a small flat-blade screwdriver between the case latch and bezel while using your thumb to push out on the bezel until the latch is disengaged. Repeat this process with the bottom latch. After the latches are disengaged, using the flat-blade screwdriver, gently pry out on the bezel in several areas until the unit releases from the case.

Look for the Current Input Jumper which will be located close to the pc board area that connects to the input terminals. If a current input type is desired, position the jumper across both pins. If input type is anything other than a current input, position the jumper on only one pin.

**Thermocouple, RTD
or Voltage Input**

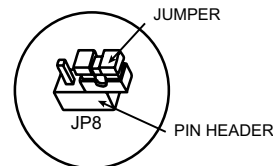

FACTORY SETTING

**Current Input
(4-20 mA or 0-20 mA)**

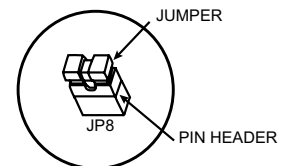

2.0 INSTALLING THE CONTROLLER

1/16 DIN Installation

The controller is designed to be mounted into an enclosed panel. The unit must be inserted in the case during installation of the controller.

Instructions:

1. Prepare the panel cutout to the proper dimensions.
2. Assemble the mounting clip by inserting the nut into the slot and then insert the screw and thread through the nut as shown (See drawing)
3. Slide the panel gasket over the rear of the controller, seating it against the lip at the front of the case.
4. Insert the controller into the panel cutout. While holding the controller in place, install the panel latch and then slide it to the farthest forward slot possible.
5. To achieve a proper seal, tighten the panel latch screws evenly until the controller is snug in the panel, torquing the screws to 13.9 to 20.8 oz-in (9.8 to 14.7 N-cm). Overtightening can result in distortion of the controller, and reduce the effectiveness of the seal.

Note: The installation location of the controller is important. Be sure to keep it away from heat sources (ovens, furnaces, etc.) and away from direct contact with caustic vapors, oils, steam, or any other process by-products in which exposure may affect proper operation.

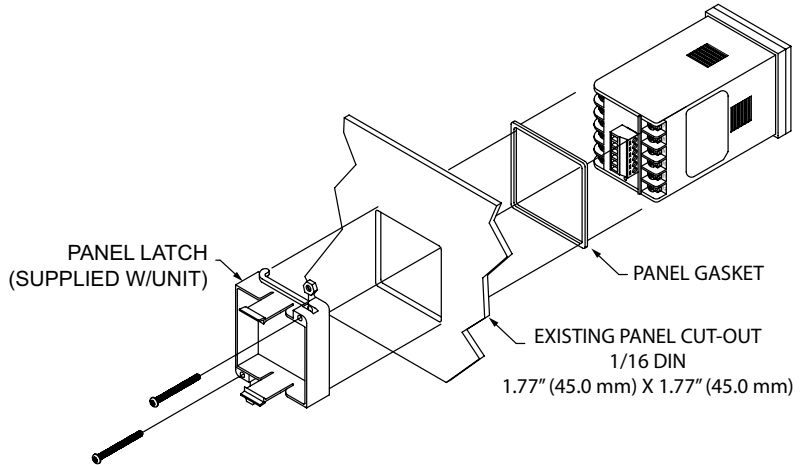

1/8 DIN Installation

The controller is designed to be mounted into an enclosed panel. The unit must be inserted in the case during installation of the controller.

Instructions:

1. Prepare the panel cutout to the proper dimensions.
2. Assemble the mounting clip by inserting the nut into the slot and then insert the screw and thread through the nut as shown (See drawing)
3. Slide the panel gasket over the rear of the controller, seating it against the lip at the front of the case.
4. Insert the controller into the panel cutout. While holding the controller in place, install the panel latches and then slide them to the farthest forward slot possible.
5. To achieve a proper seal, tighten the panel latch screws evenly until the controller is snug in the panel, torquing the screws to 13.9 to 20.8 oz-in (9.8 to 14.7 N-cm). Overtightening can result in distortion of the controller, and reduce the effectiveness of the seal.

Note: The installation location of the controller is important. Be sure to keep it away from heat sources (ovens, furnaces, etc.) and away from direct contact with caustic vapors, oils, steam, or any other process by-products in which exposure may affect proper operation.

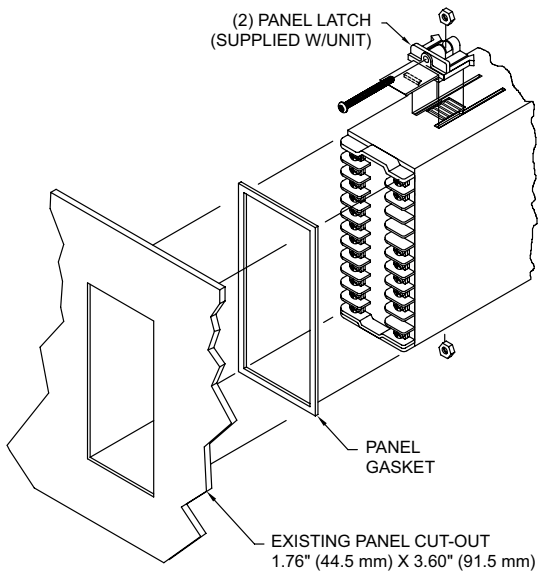

1/4 DIN Installation

The controller is designed to be mounted into an enclosed panel. The unit must be inserted in the case during installation of the controller.

Instructions:

1. Prepare the panel cutout to the proper dimensions.
2. Assemble the mounting clip by inserting the nut into the slot and then insert the screw and thread through the nut as shown (See drawing)
3. Slide the panel gasket over the rear of the controller, seating it against the lip at the front of the case.
4. Insert the controller into the panel cutout. While holding the controller in place, install the panel latches and then slide them to the farthest forward slot possible.
5. To achieve a proper seal, tighten the panel latch screws evenly until the controller is snug in the panel, torquing the screws to 13.9 to 20.8 oz-in (9.8 to 14.7 N-cm). Overtightening can result in distortion of the controller, and reduce the effectiveness of the seal.

Note: The installation location of the controller is important. Be sure to keep it away from heat sources (ovens, furnaces, etc.) and away from direct contact with caustic vapors, oils, steam, or any other process by-products in which exposure may affect proper operation.

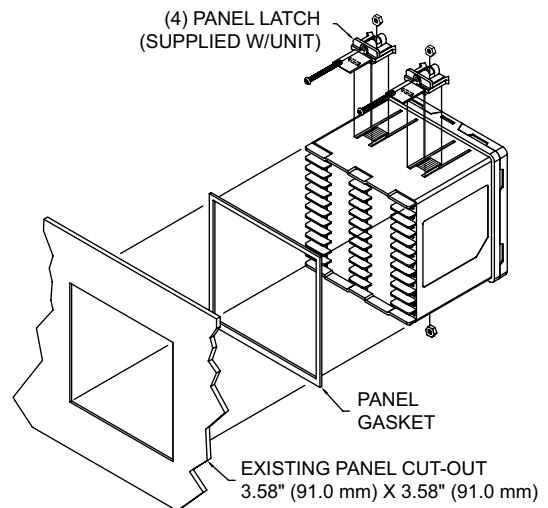

3.0 WIRING THE CONTROLLER

WIRING CONNECTIONS

All wiring connections are made to the rear screw terminals. When wiring the controller, use the numbers on the label and those embossed on the back of the case, to identify the position number with the proper function.

All conductors should meet voltage and current ratings for each terminal. Also, cabling should conform to appropriate standards of good installation, local codes and regulations. It is recommended that power (AC or DC) supplied to the controller be protected by a fuse or circuit breaker. Strip the wire, leaving approximately 1/4" (6 mm) bare wire exposed (stranded wires should be tinned with solder). Insert the wire under the clamping washer and tighten the screw until the wire is clamped tightly.

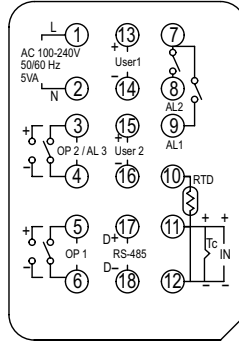

1/16 DIN

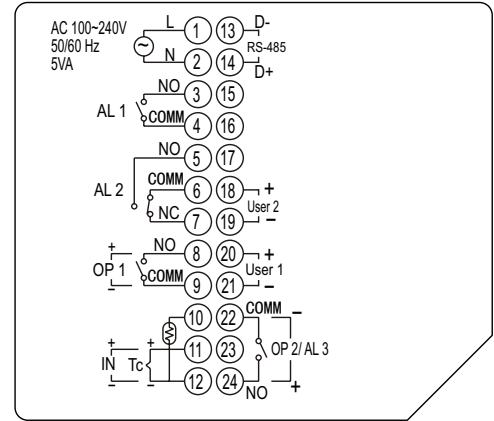

1/8 or 1/4 DIN

CONTROLLER POWER CONNECTIONS

For best results, the power should be relatively "clean" and within the specified limits. Drawing power from heavily loaded circuits or from circuits that also power loads that cycle on and off should be avoided. It is recommended that power supplied to the controller be protected by a fuse or circuit breaker.

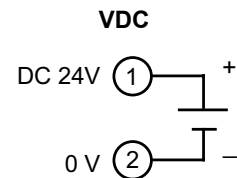
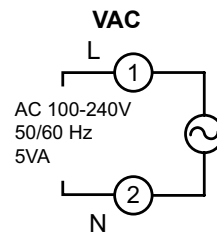

INPUT CONNECTIONS

For two wire RTDs, install a copper sense lead of the same gauge and length as the RTD leads. Attach one end of the wire at the probe and the other end to input common terminal. This is the preferred method as it provides complete

lead wire compensation. If a sense wire is not used, then use a jumper. A temperature offset error will exist. The error may be compensated by programming a temperature offset.

RTD and Resistance

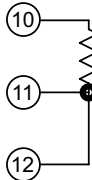

Thermocouple and Millivolt

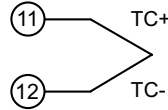

Voltage and Current

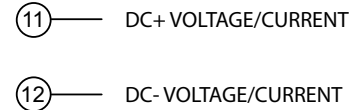

CONTROL AND ALARM OUTPUT CONNECTIONS

Alarm 1 and 2 * (1/16 DIN Shown)

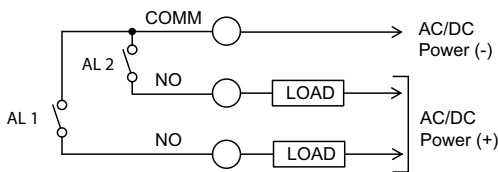

OP1/OP2 Output Control Relay *

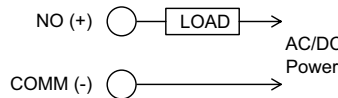

OP1 Output Control Logic/SSR *

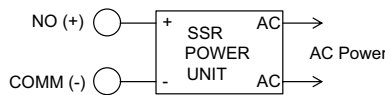

OP1 Output Control Analog *

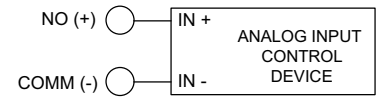

USER INPUT CONNECTIONS *

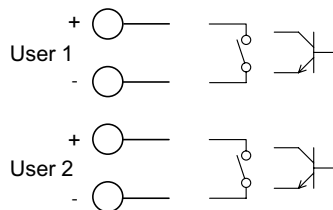

RS 485 CONNECTIONS *

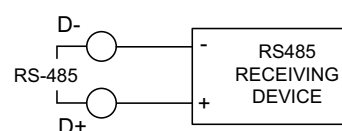

* See unit label for terminal identification.

4.0 REVIEWING THE FRONT KEYS AND DISPLAY

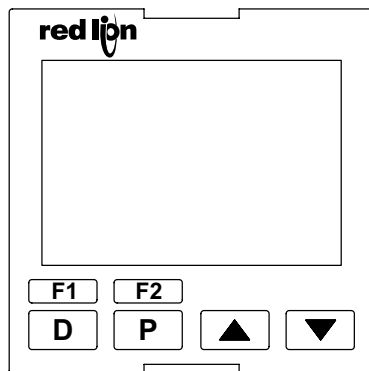

FRONT PANEL KEYS

D In the Display Loop, the D key is pressed to identify the display parameter and to advance to the next enabled display item. In all other loops, the D key is pressed to exit (or escape) directly to the first enabled Display Loop item.

P The P key is pressed to advance to the next parameter, to activate a selection/value change, and to enter the Hidden Loop when held for three seconds.



The Arrow keys are used to scroll through parameter selections/values and in the Configuration Loop they are used to scroll to the appropriate Parameter Module.



The F1/F2 keys are used to perform the function assigned to the key in Configuration Module 1.

5.0 PROGRAMMING LOOPS

DISPLAY/PARAMETER/HIDDEN LOOP REFERENCE TABLE

PARAMETER	DESCRIPTION	RANGE/UNITS	FACTORY SETTING
SPx	Active Setpoint Value	Input Range Dependent	0
OP 1	Control Output 1	0 to 100%	0.0
OP 2	Control Output 2	0 to 100%	0.0
SPrP	Setpoint Ramp Rate	0 to 999 display units/minute	0
P Id	PID Group	1 or 2	1
r - S	Controller Status	rUN or StOP	rUN
OPPF	Output Power Offset		
ProP	Proportional Band	0 to 9999 % display units	70
Intt	Integral Time	0 to 9999 seconds.	120
dEr t	Derivative Time	0 to 9999 seconds per repeat	30
d Int	Integration Default	Default Integration Value 0.0 to 100.0%	0.0
AL - 1	Alarm 1 Value	Input Range Dependent	100
AL - 2	Alarm 2 Value	Input Range Dependent	200
AL - 3	Alarm 3 Value	Input Range Dependent	300
ALrS	Alarm reset	1-2 (Resets AL1; Resets AL2)	
ALrS	Alarm Reset	3 (Resets AL3)	
SPSL	Setpoint Select	SP- 1 or SP- 2	SP- 1
tUNE	Auto-Tune Start	NO or YES	NO
Ctrl	Control Mode	OnPF or P Id	P Id
tranF	Control Mode Transfer	Auto or USER	Auto
dEu	Setpoint Deviation	Display Units	
Code	Access Code	- 125 to 125	0

DISPLAY LOOP

At power up, all display segments light, and then the programmed input type and the controller's software version will flash. Then the Temperature/Process Value is shown in the top display, and the bottom display will show the first Display Loop parameter configured as *dISP* in Configuration Module 3.

Pressing the **[D]** key will advance the bottom display to the next Display Loop parameter. After viewing the last parameter, the display will loop back to the beginning of the Display Loop. If the bottom display is blank, it is because there are no parameters enabled for display in the Display Loop.

Changes made to parameters are effective immediately. Parameters that can be displayed in the Display Loop include:

SP OP1 OP2 SPrP Pld r-5 dEu

Pressing the **[P]** key will advance the bottom display to the Parameter Loop.

PARAMETER LOOP

Pressing the **[P]** key, while in the Display Loop, will advance the bottom display to the Parameter Loop. Applicable items configured as *PRrR* in Configuration Module 3 will be displayed in the Parameter Loop. Each press of the **[P]** key will advance the bottom display to the next Parameter Loop parameter. After viewing the last parameter the display will loop back to the beginning of the Parameter Loop. Pressing the **[P]** key while parameters are not configured as *PRrR* in Module 3, will cause the bottom display to remain in the Display Loop and advance to the first Display Loop parameter.

Pressing the **[D]** key will return the display to the Display Loop. To accept a parameter change, the **[P]** key must be pressed prior to pressing the **[D]** key.

The unit will automatically exit to the Display Loop after approximately one minute of no key presses.

Parameters that can be displayed in the Parameter Loop include:

*SP OP1 OP2 SPrP Pld r-5 OPDF PraP
Inkt dErk dInk RL-1 RL-2 RL-3 RLr5 SPSL*

HIDDEN LOOP

Press and Hold the **[P]** key for 3 seconds to enter the Hidden Loop. If a lockout code 1 thru 125 has been configured in Module 3 (*Code*), the correct access code will need to be entered prior to gaining access to the Hidden Loop. If a User Input is configured for *PLOC* (program disable), the User Input will need to be de-activated prior to gaining access to the Hidden Loop. Factory programmed setting for Code = 0, and the User Inputs are not configured.

After accessing the Hidden Loop, each consecutive press of the **[P]** button will advance the bottom display through the applicable parameters selected as *HadE* in Module 3. The last item in the Hidden Loop is either *Code* or *ANFP*. If a lockout code -1 thru -125 has been configured in Module 3 (*Code*), the correct access code will need to be entered prior to gaining access to the Configuration Loop. Pressing **[P]** while *ANFP* is selected as *AD* will exit to the first parameter in the Display Loop.

To accept a parameter change, the **[P]** key must be pressed prior to pressing the **[D]** key. Pressing the **[D]** key will return the display to the Display Loop.

The unit will automatically exit to the Display Loop after approximately one minute of no key presses.

Parameters that can be displayed in the Hidden Loop include:

*SP OP1 OP2 SPrP Pld r-5 OPDF PraP Inkt dErk
dInk RL-1 RL-2 RL-3 RLr5 SPSL tUNE Ctrl brAF*

ACCESS CODE



If the Access Code is set from 1 to 125, in Lockout Module 3-11, *Code* will appear prior to gaining access to the Hidden Loop. By entering the proper code, access to the Hidden Loop is permitted. With the factory setting of 0, *Code* will not appear in the Hidden Loop.

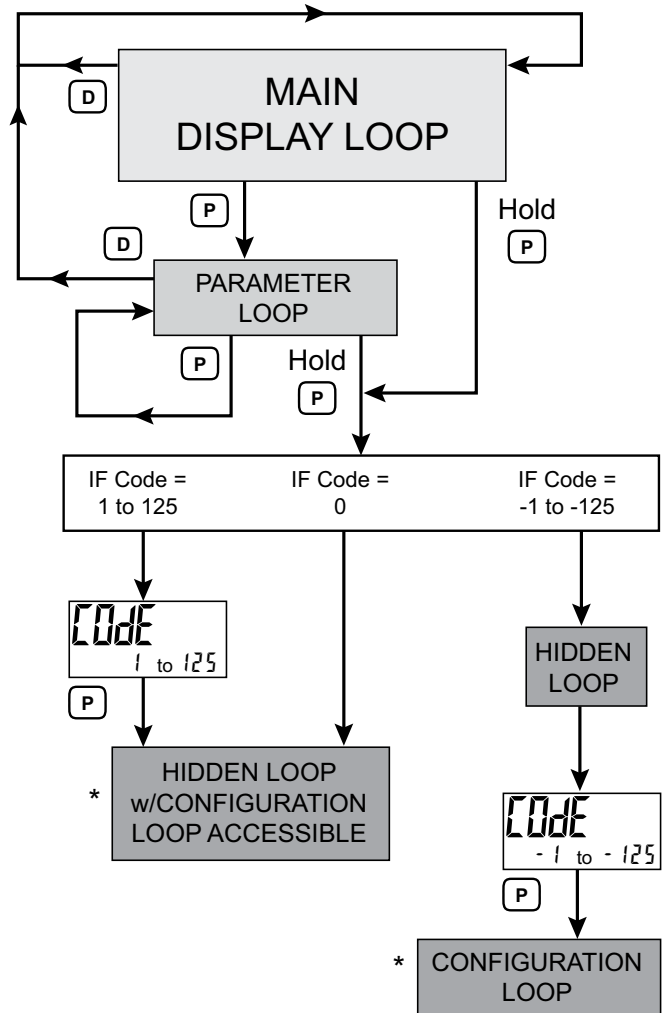

* If PLOC is active, the Configuration Loop is not accessible.

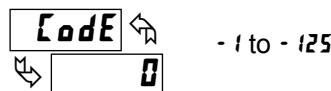

If the Access Code is set from -1 to -125, in Lockout Module 3-11, *Code* will appear as the last Hidden Loop item. By entering the proper code, access to the Configuration Loop is permitted (with a negative code value, the Hidden Loop can be accessed without the use of a code). With an active User Input configured for Program Lock (*PLOC*), *Code* will not appear. An active user input configured for Program Lock (*PLOC*) always locks out the Configuration Loop, regardless of Access Code.

DISPLAY/PARAMETER/HIDDEN LOOP PARAMETER DESCRIPTIONS

The following parameters may be locked from display or made available in either the main Display Loop, the Parameter Loop or the Hidden Loop as configured in programming module 3-L7. Values configured for *dSPr* are read only when in the main display loop, but are writable when in the Hidden Loop. The value mnemonics are shown for each parameter, as well as the factory setting for each of the values.

ACTIVE SETPOINT VALUE

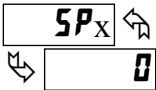

-999 to 9999 display units *

The parameter name indicates the active setpoint. The Setpoint value can be changed by pressing the arrow keys. This parameter can be configured as read only in the Display Loop, but read/write in the Hidden Loop (*dSPr*). Select the second Setpoint value by using the [F1] or [F2] key, user input, or the *SP5L* parameter. Both Setpoint values are limited by the Setpoint Low and High Limits in Input Module 1-#.

CONTROL OUTPUT 1 or 2 % OUTPUT POWER

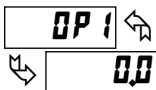

0.0 to 100.0

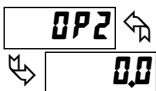

While the controller is in Automatic Mode, this value is read only. When the controller is placed in Manual Mode, the value can be changed by pressing the arrow keys. For more details on % Output Power, see Control Mode Explanations.

SETPOINT RAMP RATE



0 to 999 display units/minute *

By ramping the setpoint at a controlled rate, the setpoint ramp rate can reduce sudden shock to the process and reduce overshoot on startup or after setpoint changes. When viewing setpoint value, and the setpoint is ramping, the setpoint will alternate between *rSPx* and the target setpoint value. The ramp rate is in least-significant (display units) digits per minute. A value of 0 disables setpoint ramping. Once the ramping setpoint reaches the target setpoint, the setpoint ramp rate disengages until the setpoint is changed again. If the ramp value is changed during ramping, the new ramp rate takes effect. If the setpoint is ramping prior to starting Auto-Tune, the ramping will terminate when Auto-Tune starts. Deviation and band alarms are relative to the target setpoint, not the ramping setpoint. A slow process may not track the programmed setpoint rate. At power up, the ramping setpoint is initialized to the current temperature/process value.

PID GROUP

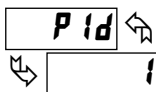

1 or 2

Select different PID parameters by choosing one of two different PID groups.

CONTROLLER STATUS

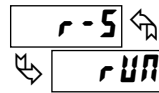

rUN *StOP*

When in *rUN* mode, the control output(s) respond based on their corresponding % output value. When in *StOP* mode, the control output(s) are disabled.

Integral wind-up can be reset by entering *StOP* and then going back to *rUN* mode.

OUTPUT POWER OFFSET



0.0 to 100.0 % power

When the Integral Time is set to zero, the power offset is used to shift the proportional band to compensate for errors in the steady state. If Integral Action is later invoked, the controller will re-calculate the internal integral value to provide “bumpless” transfer and Output Power Offset will not be necessary.

PROPORTIONAL BAND



0 to 999 display units *

The proportional band should be set to obtain the best response to a process disturbance while minimizing overshoot. For more information, see Control Mode and PID Tuning Explanations.

INTEGRAL TIME

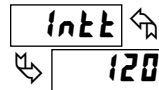

0 to 9999 seconds

Integral action shifts the center point position of the proportional band to eliminate error in the steady state. The higher the integral time, the slower the response. The optimal integral time is best determined during PID Tuning.

DERIVATIVE TIME

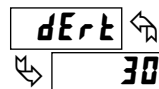

0 to 9999 seconds

Derivative time helps to stabilize the response, but too high of a derivative time, coupled with noisy signal processes, may cause the output to fluctuate too greatly, yielding poor control. Setting the time to zero disables derivative action.

INTEGRATION DEFAULT

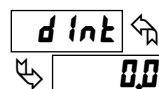

0.0 to 100.0 % output power

The Integration Default is the default integration value of integral control. When the process value enters the proportional band, the PXU will take the Integration Default as the default control output of integral control. The value is determined at Auto-Tune.

* Range/Decimal position is Programming dependent.

ALARM RESET

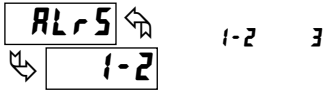

This parameter provides for the ability to individually reset active alarms from the front panel, without using [F1] or [F2] function keys. When **ALr5** is displayed with **1-2** on bottom display, pressing the ▲ key, under the 1, will reset an active Alarm 1. Pressing the ▼ key, under the 2, will reset an active Alarm 2. When **ALr5** is displayed with 3 on the bottom display, pressing the ▼ key, under the 3, will reset an active Alarm 3. All alarms may be simultaneously reset from the front panel by using User [F1] or [F2] programmed for **ALr5**.

SETPOINT SELECT



The **SP5L** function allows the operator to select setpoint 1 or setpoint 2 as the active setpoint value.

AUTO-TUNE START



The Auto-Tune procedure sets the Proportional Band, Integral Time, Derivative Time, Integration Default, and relative Gain (Heat/Cool) values appropriate to the characteristics of the process. This parameter allows front panel starting **YES** or stopping **NO** of Auto-Tune. For more information, see PID Tuning Explanations.

AUTO CONTROL MODE

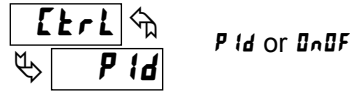

Select the desired control mode. When OnOF is selected, the PID parameters are not available.

CONTROL MODE TRANSFER



In Automatic Mode (**Auto**), the percentage of Output Power is automatically determined by the controller based on the Auto Control Mode selected. In Manual/User Mode (**USER**), the percentage of Output Power is adjusted manually by the user. The Control Mode can also be transferred through the [F1] or [F2] key or User Input. For more information, see Control Mode Explanations.

SETPOINT DEVIATION VALUE

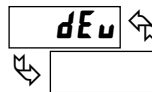

Setpoint deviation is the number of display units that the input display varies from the active setpoint value. This is a read only value.

6.0 PROGRAMMING: CONFIGURATION LOOP

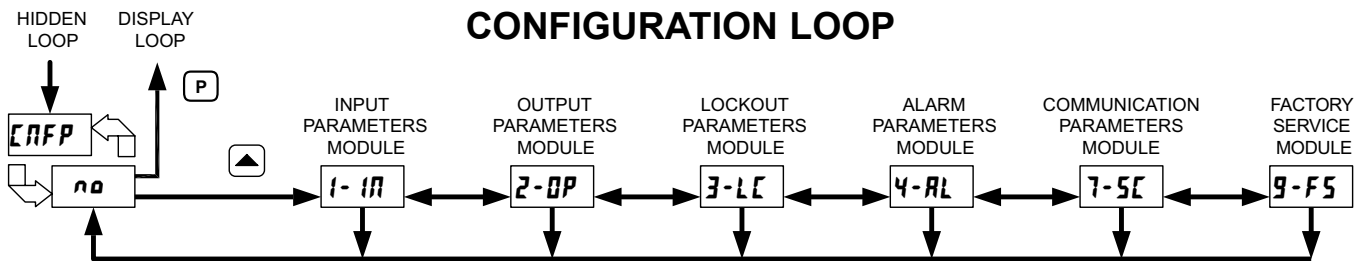

To access the Configuration Loop, press the up key when **Ctrl/NO** is displayed in the Hidden Loop. In the Configuration Loop, **Ctrl** will alternate with the parameter number in the bottom display and the Temperature/Process Value is shown on the top display. The arrow keys are used to select the parameter module (1-9). To enter a specific module press [P] while the module number is displayed. In the Configuration Loop, **Ctrl** will alternate with the parameter number in the bottom display and the Temperature/Process Value is shown on the top display.

After entering a parameter module, press [P] to advance through the parameters in the module. To change a parameter's selection/value, press the arrow keys while the parameter is displayed. In the modules, the top display shows the parameter name, and the bottom display shows the selection/value. Use [P] to enter and store the selection/value that has been changed. If a power loss occurs before returning to the Display Loop, the new values should be checked for accuracy.

At the end of each module, the controller returns to **Ctrl/NO**. At this location, pressing [P] again returns the display to the the Display Loop. Pressing the ▲ key allows re-entrance to the Configuration Loop. Whenever [D] is pressed, **End** momentarily appears, the current parameter change will be aborted, and the controller returns to the Display Loop.

7.1 MODULE 1 - INPUT PARAMETERS (1-17)

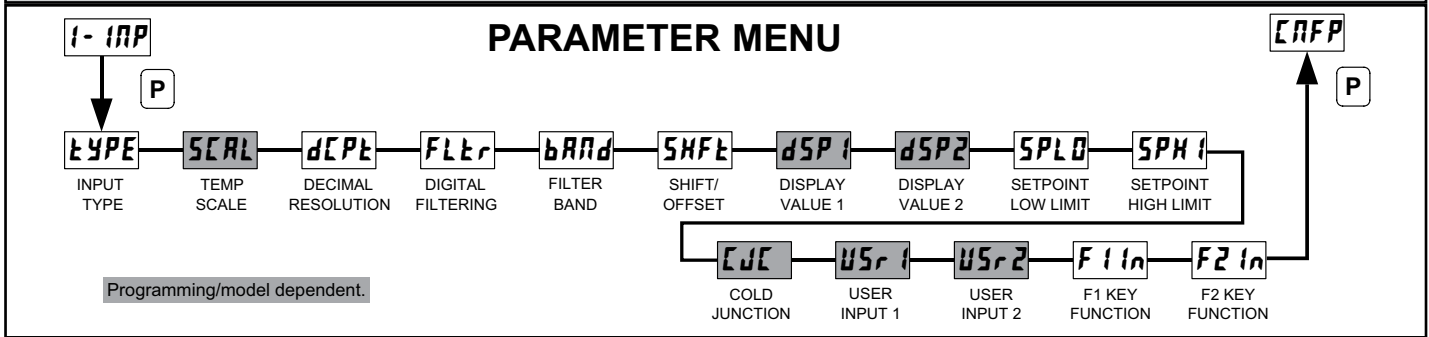

INPUT TYPE



SELECTION	TYPE	SELECTION	TYPE
tc-Y	K TC	tc-Y	TXK TC
tc-d	J TC	r392	RTD 392
tc-t	T TC	r385	RTD 385
tc-E	E TC	n1	RTD 672
tc-n	N TC	cU	Cu 50
tc-r	R TC	5u	0-5 Volt
tc-S	S TC	10u	0-10 Volt
tc-b	B TC	0-20	0-20 mA
tc-L	L TC	4-20	4-20 mA
tc-U	U TC	005u	0-50 mV

Select the input type that corresponds to the input sensor.

INPUT FILTER BAND



1 to 100 display units

The filter will adapt to variations in the input signal. When the variation exceeds the input filter band value, the digital filter disengages and a noise discrimination filter engages that rejects noise bursts. When the variation becomes less than the band value, the digital filter engages again. The value of the band is in display units.

SHIFT/OFFSET



-99 to 999 display units

This value offsets the controller's display value by the entered amount. This is useful in applications in which the sensor does not provide an accurate signal.

TEMPERATURE SCALE



°F Fahrenheit
°C Celsius

Select either degrees Fahrenheit or Celsius. If changed, check related parameter values.

* Temperature Input only.

DECIMAL RESOLUTION



0 to 00 for temperature inputs
0 to 0000 for process inputs

Select whole degrees, or tenths of degrees for Temperature display, Setpoint values, and related parameters. For thermocouple types R, S, and B, only whole degrees of resolution is available. For process inputs up to three decimal point resolution is available.

DIGITAL FILTERING



0 = least to 50 = most

The filter is an adaptive digital filter that discriminates between measurement noise and actual process changes. The equation for digital filtering is:

$$PV = \frac{\text{Last displayed PV} * n + \text{measured value}}{n + 1}$$

Where: n = Digital Filtering selection

If the signal is varying greatly due to measurement noise, increase the filter value. Decrease the filter value for quicker controller response.

DISPLAY VALUE SCALING POINT 1



-999 to 9999

Enter the first coordinate zero Display Value associated with the lower range (0V/mA, 4mA) of the input signal, by using the arrow keys.

DISPLAY VALUE SCALING POINT 2



-999 to 9999

Enter the second coordinate full scale Display Value associated with the upper range (5V, 10V, etc) of the input signal, by using the arrow keys.

* Process input only.

SETPOINT LOW LIMIT



-999 to 9999 input range dependent

The controller has a programmable low setpoint limit value to restrict the range of the setpoint. Set the limit so that the setpoint value cannot be set below the safe operating area of the process.

Shaded parameters are programming/model dependent.

SETPOINT HIGH LIMIT

SPH1 ↩
↪ **2192**

-999 to 9999 input range dependent

The controller has a programmable high setpoint limit value to restrict the range of the setpoint. Set the limit so that the setpoint value cannot be set above the safe operating area of the process.

COLD JUNCTION COMPENSATION

CJC ↩
↪ **On**

On OFF

This parameter turns the internal cold junction compensation on or off. For most applications, cold junction compensation should be enabled (**On**). This parameter does not appear if a process input type is selected.

USER INPUT FUNCTION (Model dependent)

USR1 ↩
↪ **NONE**

USR2 ↩
↪ **NONE**

The controller performs the programmed User Input selection (User Input option models), when the User terminal + is connected to User terminal -.

SELECTION	FUNCTION	DESCRIPTION
NONE	No Function	No function is performed.
r-s	Controller Status	This function can be used to start (rUA) and stop (StBP) the control function of the controller. When in StBP mode, control output 1 and 2 are disabled and output calculations are suspended.
SPSL	Setpoint 1 or 2 Select	This function selects (maintained action) Setpoint 1 (user inactive) or Setpoint 2 (user active) as the active setpoint.
trnF	Auto/Manual Select	This function selects (maintained action) Automatic (user inactive) or Manual Control (user active).
PLoC	Program Lock	The Configuration Loop is locked, as long as user input is active (maintained action).
ILoC	Integral Action Lock	The integral action of the PID computation is disabled (suspended), as long as activated (maintained action).
SPrP	Setpoint Ramp Disable	The setpoint ramping feature is disabled, as long as activated (maintained action). Any time the user input is activated with a ramp in process, ramping is aborted.
RLrS	Reset All Alarms	This function can be used to reset all of the alarms as long as activated (maintained action). Active alarms are reset until the alarm condition is cleared and triggered again (momentary action).
R1rS	Reset Alarm 1	This function can be used to reset alarm 1 as long as activated (maintained action). An active alarm is reset until the alarm condition is cleared and triggered again (momentary action).
R2rS	Reset Alarm 2	This function can be used to reset alarm 2 as long as activated (maintained action). An active alarm is reset until the alarm condition is cleared and triggered again (momentary action).
R3rS	Reset Alarm 3	This function can be used to reset alarm 3 as long as activated (maintained action). An active alarm is reset until the alarm condition is cleared and triggered again (momentary action).

F KEY FUNCTION

F1fn ↩
↪ **NONE**

F2fn ↩
↪ **NONE**

The controller performs the selected F1 Key Function, when **F1** is pressed.

SELECTION	FUNCTION	DESCRIPTION
NONE	No Function	No function is performed.
r-s	Controller Status	This function can be used to start (rUA) and stop (StBP) the control function of the controller. When in StBP mode, control output 1 and 2 are disabled and output calculations are suspended.
SPSL	Setpoint 1 or 2 Select	This function toggles (momentary action) the controller between Setpoint 1 and Setpoint 2.
trnF	Auto/Manual Select	This function toggles (momentary action) the controller between Automatic and Manual Control.
RLrS	Reset All Alarms	This function can be used to reset all of the alarms when activated (momentary action). The alarms will remain reset until the alarm condition is cleared and triggered again.
R1rS	Reset Alarm 1	This function can be used to reset alarm 1 when activated (momentary action). The alarm will remain reset until the alarm condition is cleared and triggered again.
R2rS	Reset Alarm 2	This function can be used to reset alarm 2 when activated (momentary action). The alarm will remain reset until the alarm condition is cleared and triggered again.
R3rS	Reset Alarm 3	This function can be used to reset alarm 3 when activated (momentary action). The alarm will remain reset until the alarm condition is cleared and triggered again.

Shaded parameters are programming/model dependent.

7.2 MODULE 2 - OUTPUT PARAMETERS (2-OP)

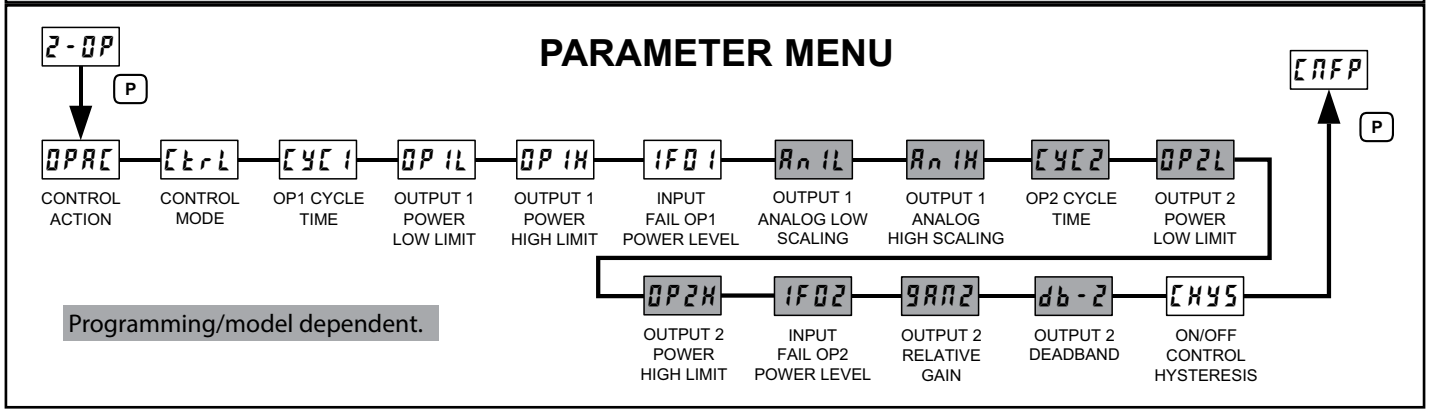

CONTROL ACTION



r = Reverse Acting
d = Direct Acting
A = Alarm 3

This determines the action for each Output. When programmed as *r1d2*, Output 1 will function in the Reverse mode (heating) and Output 2 will function in the Direct mode (Cooling). When selected as A, OP2 is configured as the alarm 3 output and the alarm 3 settings will become accessible in the Alarm module configuration menu and OP2 parameters will no longer be available.

OUTPUT 1 POWER UPPER LIMIT

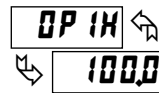

0.0 to 100.0 %

This parameter may be used to limit controller power at the upper end due to process disturbances or setpoint changes. Enter the safe output 1 power limit for the process. When the controller is in *USER* or *DNBF* Control Mode, this limit does not apply.

INPUT FAIL OP1 POWER LEVEL

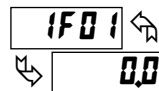

0.0 to 100.0 %

This parameter sets the power level in the event of an input failure (open TC/RTD or shorted RTD). Manual (*USER*) Control overrides the input fail preset.

CONTROL MODE



PID DNBF

Select the Control Output(s) mode of operation. This parameter can also be selected in the Hidden Loop when configured in Module 3.

OUTPUT 1 ANALOG LOW SCALING

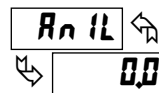

-99.9 to 99.9

The output power level that corresponds with 0 V or 4 mA analog output.

OP1 CYCLE TIME

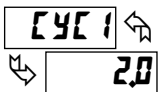

0.0 to 250.0 seconds

The Cycle Time is entered in seconds with one tenth of a second resolution. It is the total time for one on and one off period of an OP1 time proportioning control output. With time proportional control, the percentage of power is converted into an output on-time relative to the cycle time value set. (If the controller calculates that 65% power is required and a cycle time of 10.0 seconds is set, the output will be on for 6.5 seconds and off for 3.5 seconds.) For best control, a cycle time equal to one-tenth or less, of the natural period of oscillation of the process is recommended. When OP1 is an analog output, the Cycle Time is the analog output update time. A Cycle Time selection of 0.0 will disable the output.

OUTPUT 1 ANALOG HIGH SCALING



-99.9 to 99.9

The output power level that corresponds with 10 V or 20 mA analog output. An inverse action can be achieved by reversing the high and low scaling points.

OUTPUT 1 POWER LOWER LIMIT



0.0 to 100.0 %

This parameter may be used to limit controller power at the lower end due to process disturbances or setpoint changes. Enter the safe output 1 power limit for the process. When the controller is in *USER* or *DNBF* Control Mode or Auto Tune, this limit does not apply.

OP2 CYCLE TIME

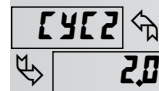

0.0 to 250.0 seconds

The Cycle Time is entered in seconds with one tenth of a second resolution. It is the total time for one on and one off period of an OP2 time proportioning control output. With time proportional control, the percentage of power is converted into an output on-time relative to the cycle time value set. (If the controller calculates that 65% power is required and a cycle time of 10.0 seconds is set, the output will be on for 6.5 seconds and off for 3.5 seconds.) For best control, a cycle time equal to one-tenth or less, of the natural period of oscillation of the process is recommended. When OP2 is an analog output, the Cycle Time is the analog output update time. A Cycle Time selection of 0.0 will disable the output.

Shaded parameters are programming/model dependent.

OUTPUT 2 POWER LOWER LIMIT

OP2L ↩️
 ↩️ **0.0**
 0.0 to 100.0 %

This parameter may be used to limit controller power at the lower end due to process disturbances or setpoint changes. Enter the safe output 2 low power limit for the process. When the controller is in **USER** or **ON/OFF** Control Mode, this limit does not apply.

OUTPUT 2 POWER UPPER LIMIT

OP2H ↩️
 ↩️ **100.0**
 0.0 to 100.0 %

This parameter may be used to limit controller power at the upper end due to process disturbances or setpoint changes. Enter the safe output 2 high power limit for the process. When the controller is in **USER** or **ON/OFF** Control Mode, this limit does not apply.

INPUT FAIL OP2 POWER LEVEL

IF02 ↩️
 ↩️ **0.0**
 0.0 to 100.0 %

This parameter sets the power level in the event of an input failure (open TC/RTD or shorted RTD). Manual (**USER**) Control overrides the input fail preset.

RELATIVE GAIN

GR02 ↩️
 ↩️ **1.00**
 0.01 to 99.99

This defines the gain of **OP2** relative to that of heating (**OP1**) or vice versa (**OP2**). This is illustrated in the Heat/Cool Relative Gain Figures below. After completion of Auto-Tune, this parameter will be changed.

DEADBAND/OVERLAP

db-2 ↩️
 ↩️ **2**
 -999 to 9999

This defines the deadband area between the bands (positive value) or the overlap area in which both heating and cooling are active (negative value). If a heat/cool overlap is specified, the percent output power is the sum of the heat power and the cool power. The function of Deadband/Overlap is illustrated in the Control Mode Explanations.

ON/OFF CONTROL HYSTERESIS

CHYS ↩️
 ↩️ **2**
 2 to 250

The On/Off Control Hysteresis (balanced around the setpoint) eliminates output chatter. The control hysteresis value affects both OP1 and OP2 control. The hysteresis band has no effect on PID control. On/Off Control Hysteresis is illustrated in the Control Mode explanations.

Shaded parameters are programming/model dependent.

HEAT/COOL RELATIVE GAIN FIGURES

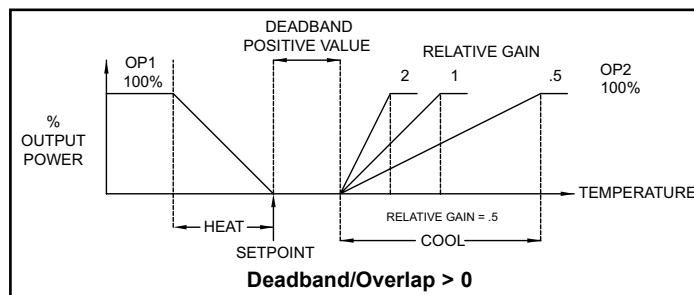
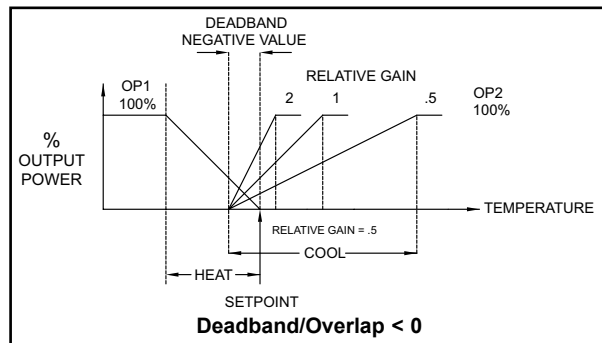
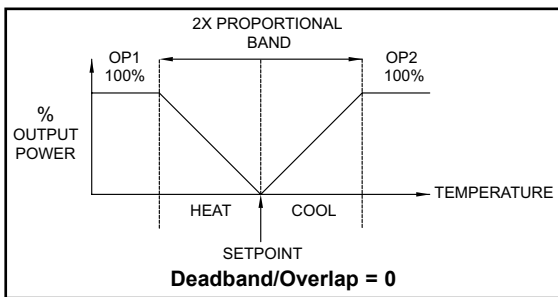

7.3 MODULE 3 - LOCKOUT PARAMETERS (3-LL)

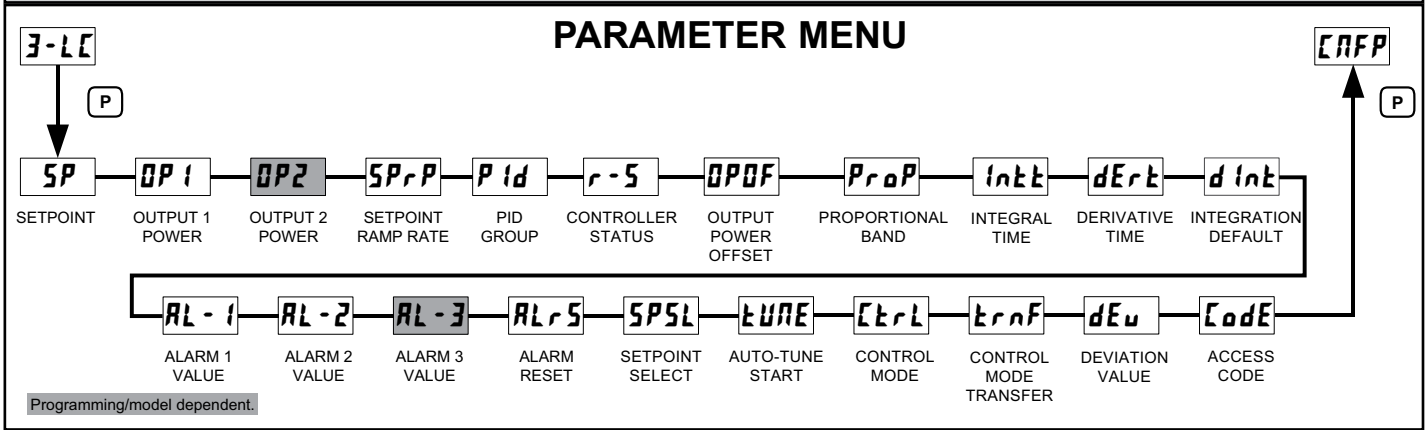

SELECTION	DESCRIPTION
d ISP	Display: accessible in Display Loop.
PR_rR	Parameter: accessible in Parameter Loop
H IdE	Hide: accessible in Hidden Loop.
LDC	Locked: not accessible in loops.
dSP_r	Display/read: read only in Display Loop, but read/write in Hidden Loop.

The following parameters can be configured for the selections described above. See Programming Loops section for a description of loops and parameters.

PARAMETER	SELECTION	FACTORY SETTING
SP	d ISP, PR_rR, H IdE, LDC, dSP_r	d ISP
OP1	d ISP, PR_rR, H IdE, LDC, dSP_r	PR_rR
OP2	d ISP, PR_rR, H IdE, LDC, dSP_r	PR_rR
SP_rP	d ISP, PR_rR, H IdE, LDC, dSP_r	PR_rR
P Id	d ISP, PR_rR, H IdE, LDC, dSP_r	PR_rR
r-S	d ISP, PR_rR, H IdE, LDC, dSP_r	d ISP
OPOF	PR_rR, H IdE, LDC	PR_rR
ProP	PR_rR, H IdE, LDC	PR_rR
Intt	PR_rR, H IdE, LDC	PR_rR
dErt	PR_rR, H IdE, LDC	PR_rR
d Int	PR_rR, H IdE, LDC	LDC
AL-1	PR_rR, H IdE, LDC	PR_rR
AL-2	PR_rR, H IdE, LDC	PR_rR
AL-3	PR_rR, H IdE, LDC	PR_rR
AL_rS	PR_rR, H IdE, LDC	PR_rR
SPSL	PR_rR, H IdE, LDC	PR_rR
tUNE	H IdE, LDC	H IdE
Ctrl	H IdE, LDC	H IdE
t_rnF	H IdE, LDC	H IdE
dEu	d ISP, LDC	d ISP

Parameters may not appear in selected loop if not applicable to current operating mode.

- Ex. 1. If **Act2 = NONE**, **AL-2** will not be displayed in selected loop.
- 2. If **Ctrl = OPOF**, PID parameters will not be displayed in selected loop.

ACCESS CODE

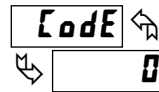

- 125 to 125

0	Full access to Display, Hidden, and Configuration Loops
-1 to -125	Code necessary to access Configuration Loop only. *
1 to 125	Code necessary to access Hidden and Configuration Loops. *

* If PLOC is active, Configuration Loop is not accessible.

Shaded parameters are programming/model dependent.

7.4 MODULE 4 - ALARM PARAMETERS (4-RL) (OPTIONAL)

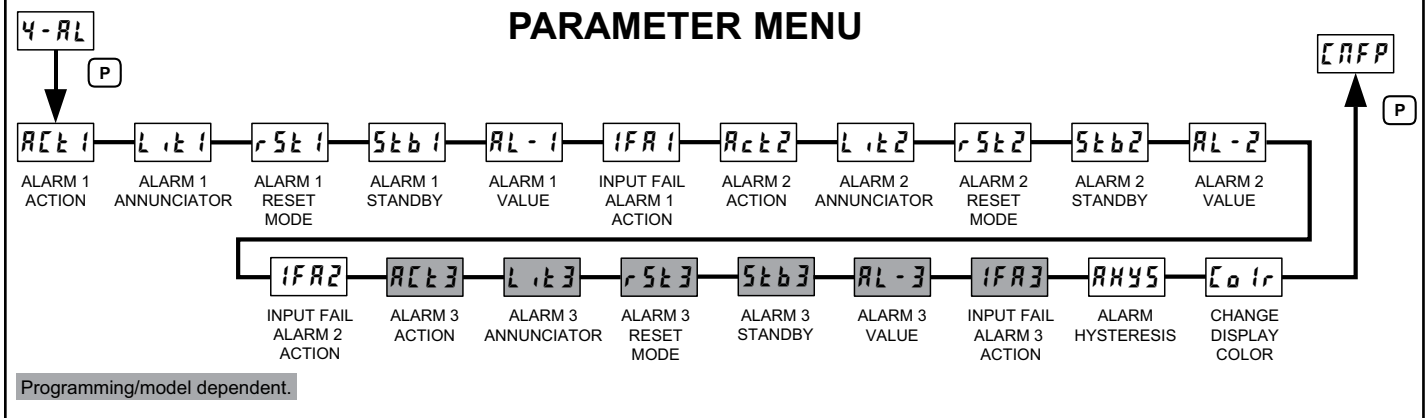

AVAILABLE ALARM ACTIONS

NONE	None	No action, the remaining Alarm parameters are not available.
RbH1	Absolute High (balanced hysteresis)	The alarm energizes when the Process Value exceeds the alarm value + 1/2 the hysteresis value.
RbL0	Absolute Low (balanced hysteresis)	The alarm energizes when the Process Value falls below the alarm value -1/2 the hysteresis value.
RuH1	Absolute High (unbalanced hysteresis)	The alarm energizes when the Process Value exceeds the alarm value.
RuL0	Absolute Low (unbalanced hysteresis)	The alarm energizes when the Process Value falls below the alarm value.

d-H1	Deviation High	The alarm value tracks the Setpoint value
d-L0	Deviation Low	The alarm value tracks the Setpoint value
b-IN	Band Acting (inside)	The alarm value tracks the Setpoint value
b-OUT	Band Acting (outside)	The alarm value tracks the Setpoint value

ALARM ACTION FIGURES

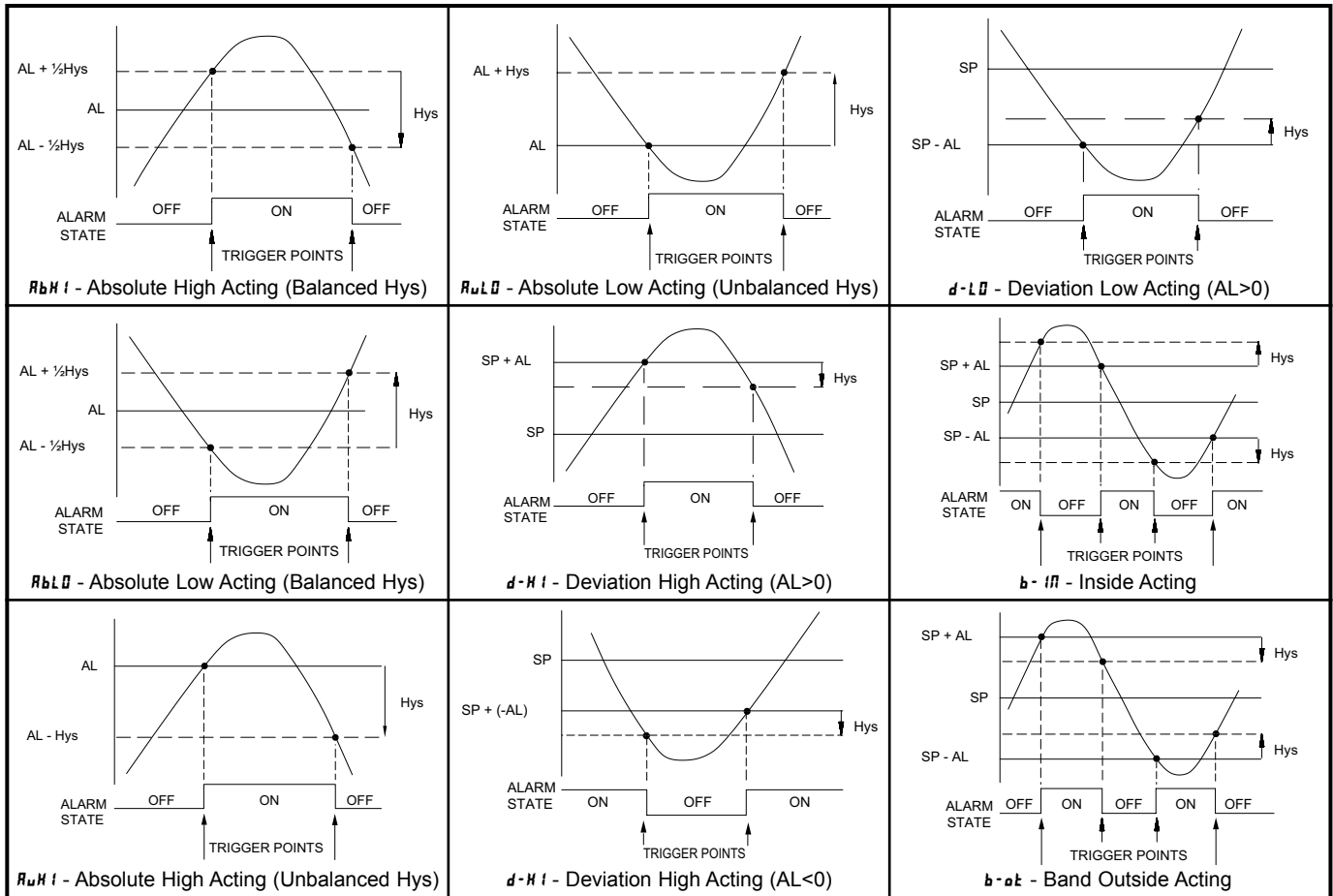

Note: Hys in the above figures refers to the Alarm Hysteresis.

ALARM 1 ACTION

ACT1 ↵
 NONE ↵

NONE *none* *AbH1* *AbLD* *AuH1* *AuLD*
d-H1 *d-LD* *b-IN* *b-ok*

Select the action for the alarm. See Alarm Action Figures at the beginning of this section for a visual explanation.

ALARM 1 ANNUNCIATOR

Lt1 ↵ *nor* Normal
 nor ↵ *rev* Reverse

With normal selection, the alarm annunciator indicates an “on” alarm output
 1. With reverse selection, the alarm annunciator indicates an “off” alarm output.

ALARM 1 RESET MODE

rSt1 ↵ *Auto* Automatic
 Auto ↵ *Latch* Latched

In Automatic mode, an energized alarm turns off automatically after the Temperature/Process value leaves the alarm region. In Latched mode, an energized alarm requires an **F1** / **F2** key or user input alarm reset to turn off. After an alarm reset, the alarm remains reset off until the trigger point is crossed again.

ALARM 1 STANDBY

Stb1 ↵ *Yes* Standby on
 NO ↵ *No* Standby off

Standby prevents nuisance (typically low level) alarms after a power up. After powering up the controller, the process must leave the alarm region (enter normal non-alarm area of operation). After this has occurred, the standby is disabled and the alarm responds normally until the next controller power up.

ALARM 1 VALUE

AL-1 ↵ *-999* to *9999*
 100 ↵

The alarm values are entered as process units or degrees. They can be entered in the Parameter or Hidden Loops, when enabled in **3-LE**. When the alarm is configured as deviation or band acting, the associated output tracks the Setpoint as it is changed. The value entered is the offset or difference from the Setpoint at which the alarm condition will occur.

INPUT FAIL ALARM 1 ACTION

IFR1 ↵ *On* *OFF*
 OFF ↵

Select the Alarm action in the event of a detected input failure (open TC/RTD or shorted RTD).

ALARM 2 ACTION

ACT2 ↵ *none* *AbH1* *AbLD* *AuH1* *AuLD*
 NONE ↵ *d-H1* *d-LD* *b-IN* *b-ok*

Select the action for the alarm. See Alarm Action Figures at the beginning of this section for a visual explanation.

ALARM 2 ANNUNCIATOR

Lt2 ↵ *nor* Normal
 nor ↵ *rev* Reverse

With normal selection, the alarm annunciator indicates an “on” alarm output
 2. With reverse selection, the alarm annunciator indicates an “off” alarm output.

ALARM 2 RESET MODE

rSt2 ↵ *Auto* Automatic
 Auto ↵ *Latch* Latched

In Automatic mode, an energized alarm turns off automatically after the Temperature/Process value leaves the alarm region. In Latched mode, an energized alarm requires an **F1** / **F2** key or user input alarm reset to turn off. After an alarm reset, the alarm remains reset off until the trigger point is crossed again.

ALARM 2 STANDBY

Stb2 ↵ *Yes* Standby on
 NO ↵ *No* Standby off

Standby prevents nuisance (typically low level) alarms after a power up. After powering up the controller, the process must leave the alarm region (enter normal non-alarm area of operation). After this has occurred, the standby is disabled and the alarm responds normally until the next controller power up.

ALARM 2 VALUE

AL-2 ↵ *-999* to *9999*
 200 ↵

The alarm values are entered as process units or degrees. They can also be entered in the Parameter or Hidden Loops. When the alarm is configured as deviation or band acting, the associated output tracks the Setpoint as it is changed. The value entered is the offset or difference from the Setpoint.

INPUT FAIL ALARM 2 ACTION

IFR2 ↵ *On* *OFF*
 OFF ↵

Select the Alarm action in the event of a detected input failure (open TC/RTD or shorted RTD).

Alarm 3 parameters in this module are programming dependent. They are available only when Output 2 control action is programmed as alarm.

ALARM 3 ACTION

ACT3 ↵ *none* *AbH1* *AbLD* *AuH1* *AuLD*
 NONE ↵ *d-H1* *d-LD* *b-IN* *b-ok*

Select the action for the alarm. See Alarm Action Figures at the beginning of this section for a visual explanation.

ALARM 3 ANNUNCIATOR

Lt3 ↵ *nor* Normal
 nor ↵ *rev* Reverse

With normal selection, the alarm annunciator indicates an “on” alarm output
 3. With reverse selection, the alarm annunciator indicates an “off” alarm output.

Shaded parameters are programming/model dependent.

ALARM 3 RESET MODE

rSt3 ↵
Auto ↵
Auto ↵
Auto Automatic
Latched Latched

In Automatic mode, an energized alarm turns off automatically after the Temperature/Process value leaves the alarm region. In Latched mode, an energized alarm requires an **F1** / **F2** key or user input alarm reset to turn off. After an alarm reset, the alarm remains reset off until the trigger point is crossed again.

ALARM 3 STANDBY

Stb3 ↵
NO ↵
NO Standby on
NO Standby off

Standby prevents nuisance (typically low level) alarms after a power up. After powering up the controller, the process must leave the alarm region (enter normal non-alarm area of operation). After this has occurred, the standby is disabled and the alarm responds normally until the next controller power up.

ALARM 3 VALUE

AL-3 ↵
300 ↵
 -999 to 9999

The alarm values are entered as process units or degrees. They can also be entered in the Parameter or Hidden Loops. When the alarm is configured as deviation or band acting, the associated output tracks the Setpoint as it is changed. The value entered is the offset or difference from the Setpoint.

INPUT FAIL ALARM 3 ACTION

IFR3 ↵
OFF ↵
On OFF

Select the Alarm action in the event of a detected input failure (open TC/RTD or shorted RTD).

ALARM HYSTERESIS

AHYS ↵
1 ↵
 0 to 250

The Hysteresis Value is either added to or subtracted from the alarm value, depending on the alarm action selected. The same value applies to both alarms. See the Alarm Action Figures at the beginning of this section for a visual explanation of how alarm actions are affected by the hysteresis.

CHANGE COLOR

Colr ↵
OFF ↵
 OFF ANY AL-1 AL-2 **AL-3**

Select alarm(s) to change Input Display color intensity when appropriate alarm(s) are triggered.

Shaded parameters are programming/model dependent.

7.5 MODULE 7 - SERIAL COMMUNICATIONS PARAMETERS (7-5E)

PARAMETER MENU

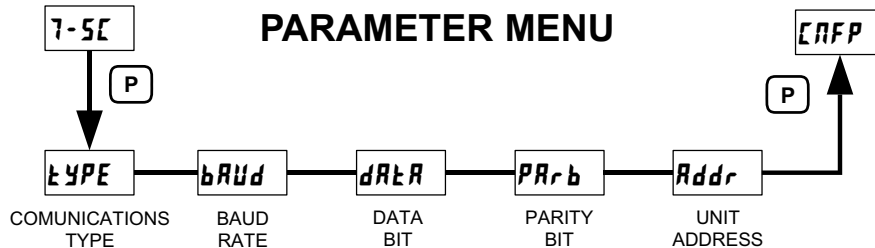

COMMUNICATIONS TYPE

tYPE ↵
rTU ↵
rTU ModBus RTU
ASC ModBus ASCII

Select the desired communications protocol.

PARITY BIT

PARb ↵
NO ↵
NO **Even** **Odd**

Set the parity bit to match that of the other serial communications equipment used.

BAUD RATE

bAUD ↵
3844 ↵
 2400 9600 3844
 4800 1920

Set the baud rate to match that of other serial communications equipment. Normally, the baud rate is set to the highest value that all of the serial communications equipment is capable of transmitting.

UNIT ADDRESS

Addr ↵
247 ↵
 1 to 247

Select a Unit Address that does not match an address number of any other device on the serial link.

DATA BIT

dAtA ↵
8 ↵
 7 8

Select either 7 or 8 bit data word lengths. Set the word length to match that of other serial communication equipment. If **rTU** is selected as the communication type, **dAtA** defaults to 8.

SERIAL COMMUNICATIONS

When using a PXU with RS485 communications option, the PXU will support Modbus communications. Unit configuration, as well as data interrogation, can be accomplished through Modbus communications. The PXU allows for 32 Read / Write registers. A complete list of Modbus registers is available at the end of this document.

CRIMSON SOFTWARE

Crimson is a Windows® based program that allows configuration of the PXU controller from a PC. Crimson offers standard drop-down menu commands to make it easy to program the PXU controller, the PXU database can then be saved in a PC file for future use. The Crimson 2.0 software is available at www.redlion.net. An RS-485 PC card or USB to RS485 converter and cabling is required. Prior to downloading or extracting the database, the PXU must be set to Modbus RTU communications type. The proper communications port, baud rate, and unit address must be configured in the Link, Options dialog and must match the baud rate and unit address configured in the PXU serial communications module (1-5).

PXU CONFIGURATION USING CRIMSON

1. Install Crimson software, available for download at www.redlion.net.
2. Connect communications cable from PXU to PC.
3. Supply power to PXU.
4. Configure serial parameters as Modbus RTU (rtu), 38,400 baud, address 247.
5. Create a new file (File, New) or open an existing PXU database within Crimson.
6. Configure Crimson 2 Link options (Link, Options) to the serial port which the communication cable is attached (in step 2).
7. Select Update (Link, Update).

PXU FREQUENTLY USED MODBUS REGISTERS

Only frequently used registers are shown below. The entire Modbus Register Table can be found at the end of this document.

The following is an example of the necessary query and corresponding response for holding register 2. In this example register 2 is the decimal value 123.

Query: 01 03 00 01 00 01 D5 CA

Response: 01 03 02 00 7B F8 67

Notes:

1. The PXU registers can be read as holding (4x) or input (3x) registers.
2. The PXU should not be powered down while parameters are being changed. Doing so may result in an in-complete write to the non-volatile memory and produce checksum errors.

REGISTER (4x)	REGISTER NAME	LOW LIMIT	HIGH LIMIT	FACTORY SETTING	ACCESS	COMMENTS
1	Process Value (PV)	N/A	N/A	N/A	Read	1 = 1 Display unit
2	Active Setpoint (SP)	-999	9999	0	Read/Write	1 = 1 Display unit
3	Setpoint 1 (SP1)	-999	9999	0	Read/Write	1 = 1 Display unit
4	Setpoint 2 (SP2)	-999	9999	0	Read/Write	1 = 1 Display unit
5	Setpoint Deviation	N/A	N/A	N/A	Read Only	1 = 1 Display unit
6	Alarm 1 Value	-999	9999	100	Read/Write	1 = 1 Display unit
7	Alarm 2 Value	-999	9999	200	Read/Write	1 = 1 Display unit
8	Alarm 3 Value	-999	9999	300	Read/Write	1 = 1 Display unit
9	Output Power 1	0	1000	0	Read/Write	1 = 0.1%; writable when in manual mode only.
10	Output Power 2	0	1000	0	Read/Write	1 = 0.1%; writable when in manual mode only.
11	PB Proportional band (Active)	1	999(.9)° or 9999 (process)	70	Read/Write	1 = 1 Display unit
12	Integral time (Active)	0	9999	120	Read/Write	1 = 1 second
13	Derivative time (Active)	0	9999	30	Read/Write	1 = 1 second
14	Integration default (Active)	0	1000	0	Read/Write	1 = 0.1 % output power
15	PID parameter set selection	0	1	0	Read/Write	0 = PID Set 1, 1 = PID Set 2
16	Auto-Tune Start	0	1	0	Read/Write	0 = No; 1 = Yes
17	Control Mode Transfer (Auto/Manual)	0	1	0	Read/Write	0 = Automatic (PID), 1 = User (Manual Mode)
18	Controller Status	0	1	1	Read/Write	0: Stop, 1: Run
19	Setpoint Select	0	1	0	Read/Write	0=SP1, 1=SP2
20	SP Ramp Rate	0	9999	0	Read/Write	1 = 1 Display unit/minute
21	LED Status	N/A	N/A	N/A	Read Only	b0: ALM3, b1: ALM2, b2: F, b3: C, b4: ALM1, b5: OUT2, b6:OUT1, b7: AT
22	Pushbutton Status	N/A	N/A	N/A	Read Only	b1: F2, b2: Down, b3: P, b5: F1, b6: Up, b7: D; 0 = Key pressed, 1 = Key not pressed
23	Alarm Reset	0	7	0	Write	b0: Reset Alm1, b1: Reset Alm2, b3: Reset Alm3
24	Setpoint Ramping Disable	0	1	0	Read/Write	0 = Enabled, 1 = Disabled
25	Integral Action Disable	0	1	0	Read/Write	0 = Enabled, 1 = Disabled

7.5 MODULE 9 FACTORY SERVICE OPERATIONS (9-F5)

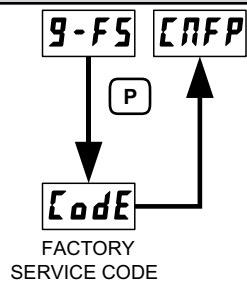

PARAMETER MENU

RESTORE FACTORY SETTINGS

Code
55

Press and hold **▲** to display **Code 55**. Press **P**. The controller will display **55E** and then return to **CONF**. Press **D** to return to the Display Loop. This will overwrite all user settings with Factory Settings.

TROUBLESHOOTING

For further technical assistance, contact technical support.

PROBLEM	CAUSE	REMEDIES
NO DISPLAY	<ol style="list-style-type: none"> 1. Power off. 2. Brown-out condition. 3. Loose connection or improperly wired. 4. Controller not fully seated into case. 	<ol style="list-style-type: none"> 1. Check power. 2. Verify power reading. 3. Check connections. 4. Check installation.
CONTROLLER NOT WORKING	<ol style="list-style-type: none"> 1. Incorrect setup parameters. 2. Stop Mode. 	<ol style="list-style-type: none"> 1. Check setup parameters. 2. Change to Run mode.
... or -... IN DISPLAY	<ol style="list-style-type: none"> 1. Display value exceeds 4 digit display range. 2. Defective or miscalibrated cold junction circuit. 3. Loss of setup parameters. 4. Internal malfunction. 	<ol style="list-style-type: none"> 1. Check input parameters (Input Type). 2. Change display resolution/scaling. 3. Recalibrate controller. (Consult Factory) 4. Consult Factory
OPEN IN DISPLAY	<ol style="list-style-type: none"> 1. Probe disconnected. 2. Broken or burned-out probe. 3. Corroded or broken terminations. 4. Excessive process temperature. 	<ol style="list-style-type: none"> 1. Check probe wire/change probe. 2. Check sensor input type selection. 3. Perform cold junction calibration. (Consult Factory) 4. Perform Input calibration. (Consult Factory)
LLLL IN TOP DISPLAY	<ol style="list-style-type: none"> 1. Input exceeds range of controller. 2. Temperature exceeds range of input probe. 3. Defective or incorrect transmitter or probe. 4. Excessive high temperature for probe. 5. Loss of setup parameters. 	<ol style="list-style-type: none"> 1. Check input parameters. 2. Change to input sensor with a higher temperature range. 3. Replace transmitter or probe. 4. Reduce temperature. 5. Perform input calibration. (Consult Factory)
LLLL IN TOP DISPLAY	<ol style="list-style-type: none"> 1. Input is below range of controller. 2. Temperature below range of input probe. 3. Defective or incorrect transmitter or probe. 4. Excessive low temperature for probe. 5. Loss of setup parameters. 	<ol style="list-style-type: none"> 1. Check input parameters. 2. Change to input sensor with a lower temperature range. 3. Replace transmitter or probe. 4. Raise temperature. 5. Perform input calibration. (Consult Factory)
SHrt IN DISPLAY	<ol style="list-style-type: none"> 1. RTD probe shorted. 	<ol style="list-style-type: none"> 1. Check wiring and/or replace RTD probe.
CONTROLLER SLUGGISH OR NOT STABLE	<ol style="list-style-type: none"> 1. Incorrect PID values. 2. Incorrect probe location. 	<ol style="list-style-type: none"> 1. See PID control. 2. Evaluate probe location.
CANNOT ACCESS PROGRAMMING	<ol style="list-style-type: none"> 1. Active User Input, programmed for PLUC. 2. Incorrect access code entered. 	<ol style="list-style-type: none"> 1. Deactivate User Input. 2. Enter proper access code at Code 0 prompt. (111 or -111 = universal access code)

CONTROL MODE EXPLANATIONS

ON/OFF CONTROL

In this control mode, the process will constantly oscillate around the setpoint value. The On/Off Control Hysteresis (balanced around the setpoint) can be used to eliminate output chatter. Output Control Action can be set to reverse for heating (output on when below the setpoint) or direct for cooling (output on when above the setpoint) applications.

ON/OFF CONTROL - REVERSE OR DIRECT ACTING FIGURES

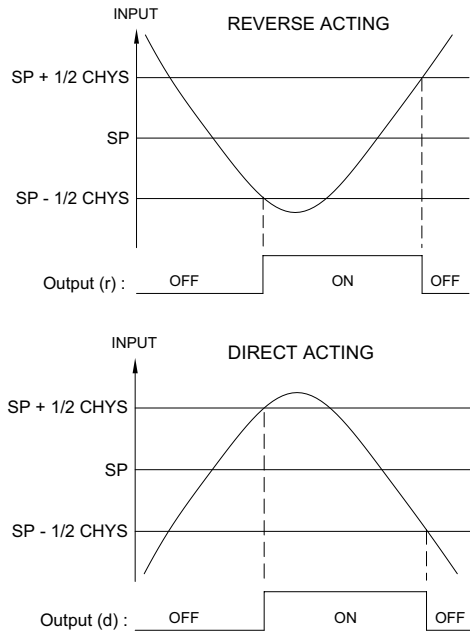

Note: CHYS in the On/Off Control Figures refers to the On/Off Control Hysteresis (CHYS) in parameter Module 2.

For heat and cool systems, Control Action parameter is used to reverse (r) for heating and direct (d) for cooling. The Deadband/Overlap in Cooling sets the amount of operational deadband or overlap between the outputs. The setpoint and the On/Off Control Hysteresis applies to both OP1 and OP2 outputs. The hysteresis is balanced in relationship to the setpoint and deadband value.

ON/OFF CONTROL - HEAT/COOL OUTPUT FIGURES

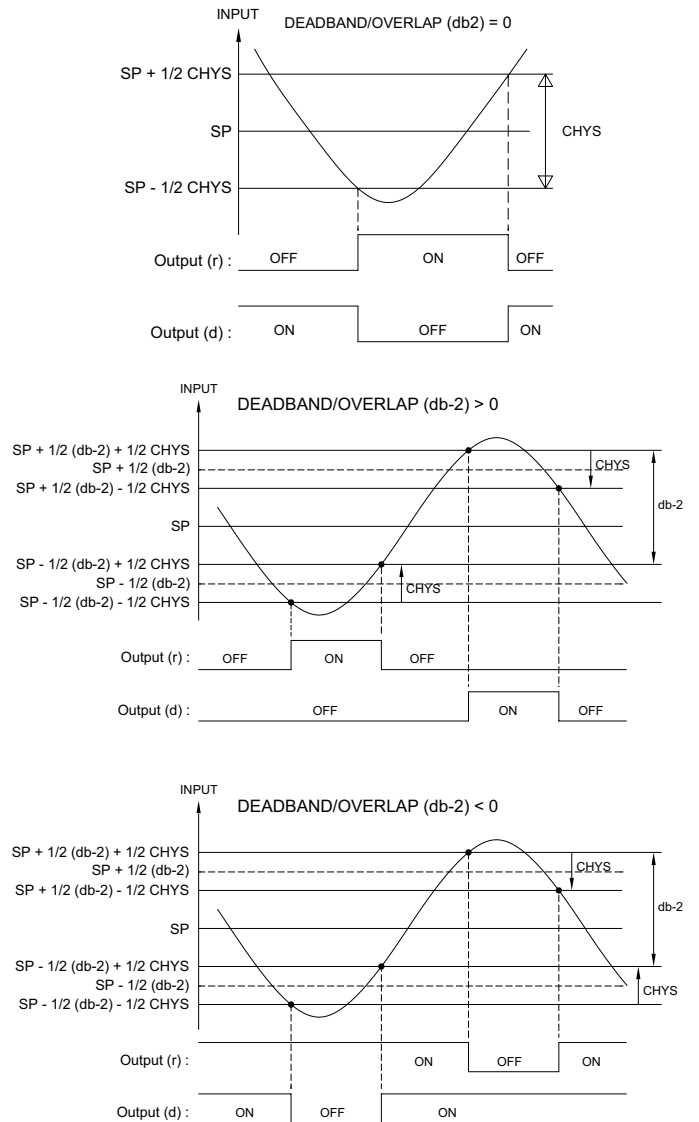

PID CONTROL

In PID Control, the controller processes the input and then calculates a control output power value by use of Proportional Band, Integral Time, and Derivative Time control algorithm. The system is controlled with the new output power value to keep the process at the setpoint. The Control Action for PID Control can be set to reverse for heating (output on when below the setpoint) or direct for cooling (output on when above the setpoint) applications. For heat and cool systems, the heat and cool outputs are both used. The PID parameters can be established by using Auto-Tune, or they can be Manually tuned to the process.

TYPICAL PID RESPONSE CURVE

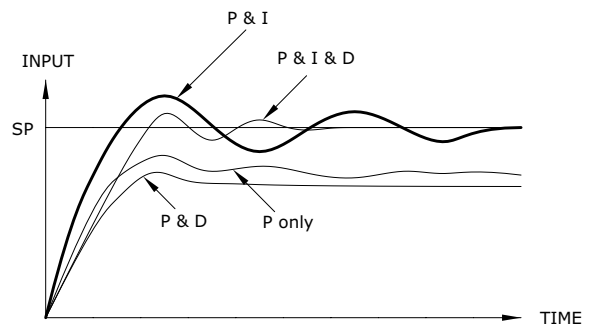

TIME PROPORTIONAL PID CONTROL

In Time Proportional applications, the output power is converted into output On time using the Cycle Time. For example, with a four second cycle time and 75% power, the output will be on for three seconds (4×0.75) and off for one second.

The Cycle Time should be no greater than 1/10 of the natural period of oscillation for the process. The natural period is the time it takes for one complete oscillation when the process is in a continuously oscillating state.

LINEAR PID CONTROL

In Linear PID Control applications, OP1 provides a linear output signal that is proportional to the calculated OP1 value (% Output Power). The PXU allows the user to program the %OP value at which the analog low (RnL) and high (RnH) output signal will be produced. The Analog Output will then be proportional to the PID calculated % output power. For example, with 0 to 10 VDC output configured as 0 (RnL) to 100 (RnH) an OP1 value of 75% provides an analog output of 7.5 VDC. Cycle Time will determine the update time of the linear output signal.

AUTOMATIC CONTROL MODE

In Automatic Control Mode, the percentage of output power is automatically determined by PID or On/Off calculations based on the setpoint and process feedback. For this reason, PID Control and On/Off Control always imply Automatic Control Mode.

MANUAL CONTROL MODE

In *USER* Control Mode, the controller operates as an open loop system, and does not use the setpoint or process feedback. The user adjusts the percentage of power through the OP1 or OP2 parameter to control the power for each Output. The Low and High Output Power limits are ignored when the controller is in Manual.

MODE TRANSFER

When transferring the controller mode between Automatic and User/Manual, the controlling outputs remain constant, exercising true “bumpless” transfer. When transferring from Manual to Automatic, the power initially remains steady, but Integral Action corrects (if necessary) the closed loop power demand at a rate proportional to the Integral Time.

PID TUNING EXPLANATIONS

AUTO-TUNE

Auto-Tune is a user-initiated function that allows the controller to automatically determine the Proportional Band, Integral Time, Derivative Time, Integration Default, and Relative Gain (Heat/Cool) values based upon the process characteristics. The Auto-Tune operation cycles the controlling output(s) at the setpoint. The nature of these oscillations determines the settings for the controller's parameters.

Prior to initiating Auto-Tune, it is important that the controller and system be first tested. This can be accomplished in On/Off Control or Manual Control Mode. If there is a wiring, system or controller problem, Auto-Tune may give incorrect tuning or may never finish. Auto-Tune may be initiated at start-up, from setpoint or at any other process point. However, ensure normal process conditions (example: minimize unusual external load disturbances) as they will have an effect on the PID calculations.

Start Auto-Tune

Below are the parameters and factory settings that affect Auto-Tune. If these settings are acceptable then Auto-Tune can be started just by performing three steps. If changes are needed, then they must be made before starting Auto-Tune.

DISPLAY	PARAMETER	FACTORY SETTING	MODULE
TYPE	Input Type	EC-J Curr	1-1A
OPAC	Output Control Action		2-OP
CHYS	On/Off Control Hysteresis	20 (temp) 20 (temp)	2-OP
ATNE	Auto-Tune Access	HiLoE	3-LC

1. Enter the Setpoint value in the Display Loop.
2. Set the On/Off Control Hysteresis (CHYS) to a value that is appropriate for the process.
3. Initiate Auto-Tune by changing ATNE to YE5 in the Hidden Loop, and then press [P].

Auto-Tune Progress

The controller will oscillate the controlling output(s) for four cycles. The **AT** annunciator will flash during this time. Parameter viewing is permitted during Auto-Tune. The time to complete the Auto-Tune cycles is process dependent.

The controller should automatically stop Auto-Tune and store the calculated values when the four cycles are complete. If the controller remains in Auto-Tune unusually long, there may be a process problem. Auto-Tune may be stopped by entering **NO** in ATNE .

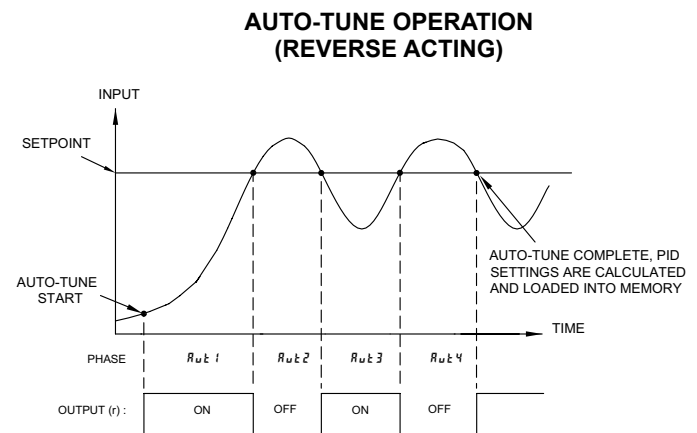

PID Adjustments

In some applications, it may be necessary to fine tune the Auto-Tune calculated PID parameters. To do this, a chart recorder or data logging device is needed to provide a visual means of analyzing the process. Compare the actual process response to the PID response figures with a step change to the process. Make changes to the PID parameters in no more than 20% increments from the starting value and allow the process sufficient time to stabilize before evaluating the effects of the new parameter settings.

In some unusual cases, the Auto-Tune function may not yield acceptable control results or induced oscillations may cause system problems. In these applications, Manual Tuning is an alternative.

PROCESS RESPONSE EXTREMES

OVERSHOOT AND OSCILLATIONS

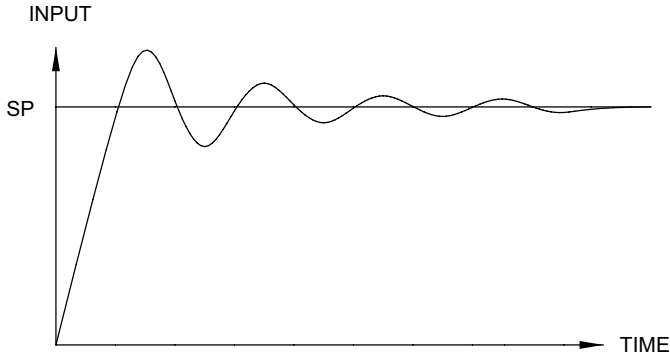

TO DAMPEN RESPONSE:

- INCREASE PROPORTIONAL BAND.
- INCREASE INTEGRAL TIME.
- USE SETPOINT RAMPING.
- USE OUTPUT POWER LIMITS.
- INCREASE DERIVATIVE TIME.
- CHECK CYCLE TIME.

SLOW RESPONSE

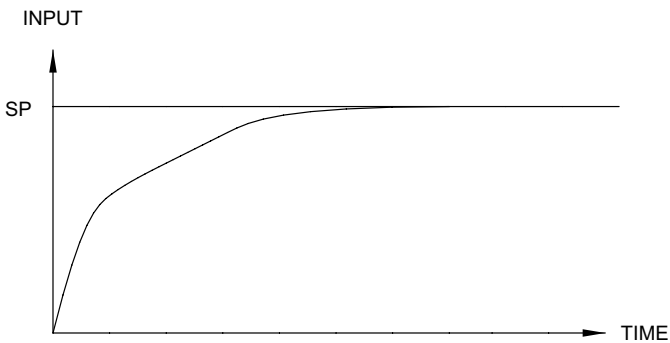

TO QUICKEN RESPONSE:

- DECREASE PROPORTIONAL BAND.
- DECREASE INTEGRAL TIME.
- INCREASE OR DEFEAT SETPOINT RAMPING.
- EXTEND OUTPUT POWER LIMITS.
- DECREASE DERIVATIVE TIME.

MANUAL TUNING

A chart recorder or data logging device is necessary to measure the time between process cycles. This procedure is an alternative to the controller's Auto-Tune function. It will not provide acceptable results if system problems exist.

1. Set the Proportional Band (*PrnP*) to 10.0% of the input range for temperature inputs and 100.0% for process inputs.
2. Set both the Integral Time (*Intk*) and Derivative Time (*derk*) to 0 seconds.
3. Set the Output Cycle Time in Output Module *Z-OP* to no higher than one-tenth of the process time constant (when applicable).
4. Place the controller in Manual (*USEr*) Control Mode (*krnF*) and adjust the % Power to drive the process value to the Setpoint value. Allow the process to stabilize after setting the % Power. Note: *krnF* must be set to *MidE* in Parameter Lockouts Module *Z-LF*.
5. Place the controller in Automatic (*Auto*) Control Mode (*krnF*). Place the value of % power into the Output Power Offset (*OPPF*). If the process will not stabilize and starts to oscillate, set the Proportional Band two times higher and go back to Step 4. Also put Output Power Offset (*OPPF*) back to zero.
6. If the process is stable, decrease Proportional Band setting by two times and change the Setpoint value a small amount to excite the process. Continue with this step until the process oscillates in a continuous nature.
7. Set the Proportional Band to three times the setting that caused the oscillation in Step 6.
8. Set the Integral Time to two times the period of the oscillation.
9. Set the Derivative Time to 1/8 (0.125) of the Integral Time.

DIGITAL POTENTIOMETER

A PXU with an analog type Control Output 1 can be used as a digital potentiometer. To use the PXU as a digital pot, configure the PXU for Manual control mode. Also configure OP1 parameter to be displayed and adjusted on display line 2. OP1 output terminals provide the analog output (digital pot) signal. The OP1 parameter displayed on line 2 is viewed in units of % output (0.0 to 100.0) only. If desired, the PXU line 1 display can be wired and configured to display the output signal level in engineering units. To do this, wire the OP1 output signal (in series for current signals and parallel for voltage signals) to the PXU's input and scale the input display for the desired Engineering units. For more detailed information regarding using a PXU as a digital potentiometer, see the "Digital Pot" Tech Note at www.redlion.net.

PARAMETER VALUE CHART

Programmer: _____ Date: _____

Controller Number: _____ Security Code: _____

INPUT MODULE (1-17)

DISPLAY	PARAMETER	FACTORY SETTING	USER SETTING
TYPE	Input Type	tc-d	_____
SEAL	Temperature Scale	OF	_____
dCPt	Decimal Resolution	0	_____
FLtr	Digital Filtering	8	_____
bAND	Input Filter Band	1	_____
SHFt	Shift/Offset	0	_____
dSP 1	Display Value Scaling Point 1	0	_____
dSP 2	Display Value Scaling Point 2	1000	_____
SPL0	Setpoint Low Limit	-148	_____
SPH 1	Setpoint High Limit	2192	_____
CJC	Cold Junction Compensation	On	_____
USr 1	User1 Function	NONE	_____
USr 2	User2 Function	NONE	_____
F1In	F1 Key Function	NONE	_____
F2In	F2 Key Function	NONE	_____

ALARM MODULE (4-RL)

DISPLAY	PARAMETER	FACTORY SETTING	USER SETTING
ACT 1	Alarm 1 Action	NONE	_____
Lkt 1	Alarm 1 Annunciator	nor	_____
rSt 1	Alarm 1 Reset Mode	RuLo	_____
Stb 1	Alarm 1 Standby	NO	_____
AL-1	Alarm 1 Value	100	_____
IFR 1	Alarm 1 Input Fail Action	OFF	_____
ACT 2	Alarm 2 Action	NONE	_____
Lkt 2	Alarm 2 Annunciator	nor	_____
rSt 2	Alarm 2 Reset Mode	RuLo	_____
Stb 2	Alarm 2 Standby	NO	_____
AL-2	Alarm 2 Value	200	_____
IFR 2	Alarm 2 Input Fail Action	OFF	_____
ACT 3	Alarm 3 Action	NONE	_____
Lkt 3	Alarm 3 Annunciator	nor	_____
rSt 3	Alarm 3 Reset	RuLo	_____
Stb 3	Alarm 3 Standby	NO	_____
AL-3	Alarm 3 Value	300	_____
IFR 3	Alarm 3 Input Fail Action	OFF	_____
RHY5	Alarm Hysteresis	1	_____
CoIr	Change Display Color	OFF	_____

OUTPUT MODULE (2-OP)

DISPLAY	PARAMETER	FACTORY SETTING	USER SETTING
OPAC	Control Action	rIr2	_____
Ctrl	Auto Control Mode	PId	_____
CYC 1	OP1 Cycle Time	20	_____
OP 1L	OP 1 Power Low Limit	00	_____
OP 1H	OP 1 Power High Limit	1000	_____
IF0 1	Input Fail OP1 Power Level	00	_____
An 1L	Analog Low	00	_____
An 1H	Analog High	1000	_____
CYC 2	OP2 Cycle Time	20	_____
OP 2L	OP 2 Power Low Limit	00	_____
OP 2H	OP 2 Power High Limit	1000	_____
IF0 2	Input Fail OP2 Power Level	00	_____
GAN 2	Relative Gain	100	_____
db-2	Deadband/Overlap	2	_____
CHY5	On/Off Control Hysteresis	2	_____

SERIAL COMMUNICATIONS MODULE (7-5E)

DISPLAY	PARAMETER	FACTORY SETTING	USER SETTING
TYPE	Communications Type	rEU	_____
bAUD	Baud Rate	3874	_____
dAR 8	Data Bit	8	_____
PAR 8	Parity Bit	NO	_____
Raddr	Unit Address	247	_____

LOCKOUT MODULE (3-LE)

DISPLAY	PARAMETER	FACTORY SETTING	USER SETTING
SP	Setpoint	dISP	_____
OP 1	Output 1 Power	PRrR	_____
OP 2	Output 2 Power	PRrR	_____
SPrP	Setpoint Ramp Rate	PRrR	_____
PId	PID Group	PRrR	_____
r-S	Controller Status	dISP	_____
OPDF	Output Power Offset	PRrR	_____
PrOP	Proportional Band	PRrR	_____
Intt	Integral Time	PRrR	_____
dErt	Derivative Time	PRrR	_____
dInt	Integration Default	LOB	_____
AL-1	Alarm 1 Value	PRrR	_____
AL-2	Alarm 2 Value	PRrR	_____
AL-3	Alarm 3 Value	PRrR	_____
ALrS	Alarm Reset	PRrR	_____
SPSL	Setpoint Select	PRrR	_____
tUNE	Auto-Tune Code	HiDE	_____
Ctrl	Auto Control Mode	HiDE	_____
trnF	Control Mode Transfer	HiDE	_____
dEv	Deviation Value	dISP	_____
Code	Access Code	0	_____

PXU PROGRAMMING QUICK OVERVIEW

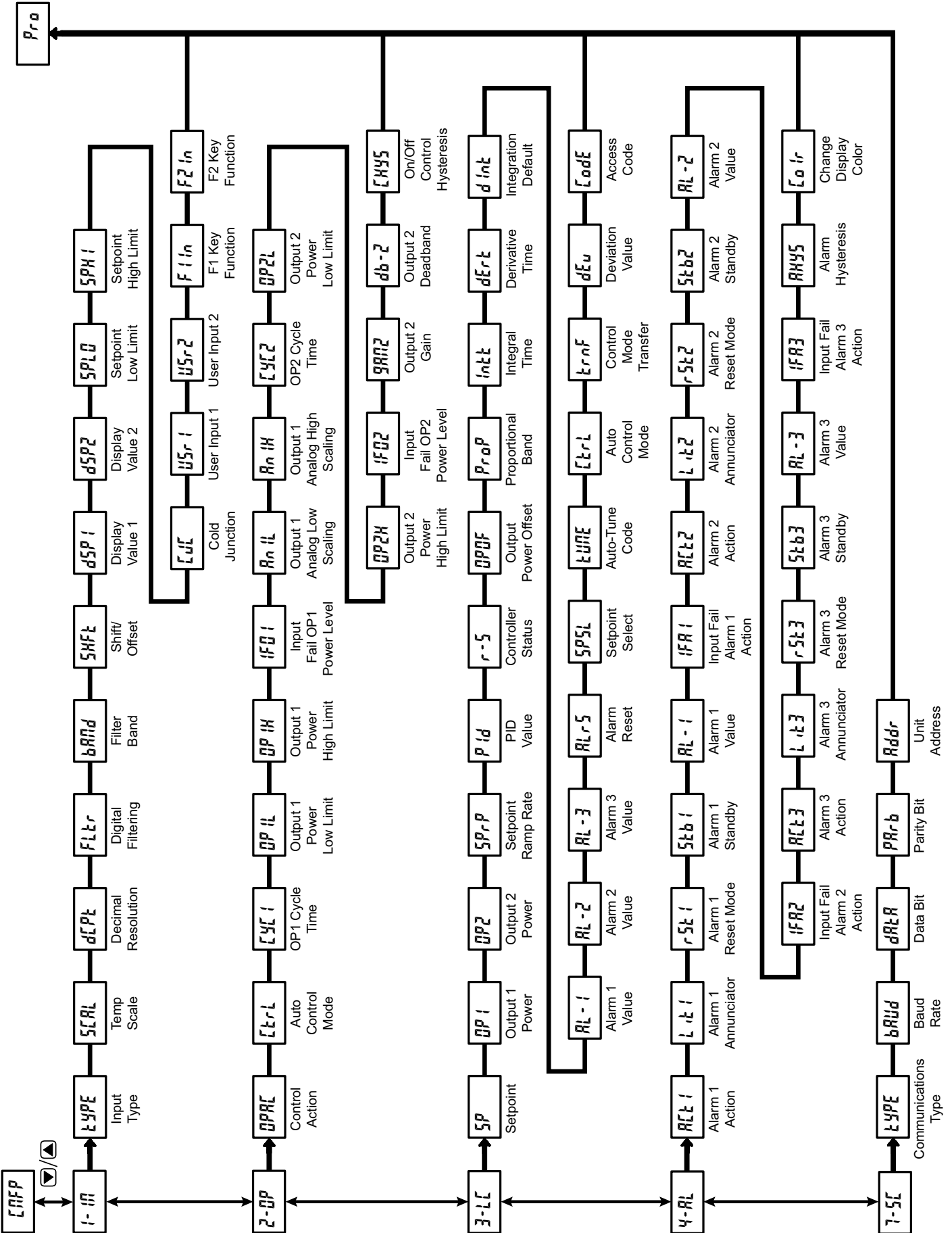

LIMITED WARRANTY

(a) Red Lion Controls Inc., Sixnet Inc., N-Tron Corporation, or Blue Tree Wireless Data, Inc. (the "Company") warrants that all Products shall be free from defects in material and workmanship under normal use for the period of time provided in "Statement of Warranty Periods" (available at www.redlion.net) current at the time of shipment of the Products (the "Warranty Period"). **EXCEPT FOR THE ABOVE-STATED WARRANTY, COMPANY MAKES NO WARRANTY WHATSOEVER WITH RESPECT TO THE PRODUCTS, INCLUDING ANY (A) WARRANTY OF MERCHANTABILITY; (B) WARRANTY OF FITNESS FOR A PARTICULAR PURPOSE; OR (C) WARRANTY AGAINST INFRINGEMENT OF INTELLECTUAL PROPERTY RIGHTS OF A THIRD PARTY; WHETHER EXPRESS OR IMPLIED BY LAW, COURSE OF DEALING, COURSE OF PERFORMANCE, USAGE OF TRADE OR OTHERWISE.** Customer shall be responsible for determining that a Product is suitable for Customer's use and that such use complies with any applicable local, state or federal law.

(b) The Company shall not be liable for a breach of the warranty set forth in paragraph (a) if (i) the defect is a result of Customer's failure to store, install, commission or maintain the Product according to specifications; (ii) Customer alters or repairs such Product without the prior written consent of Company.

(c) Subject to paragraph (b), with respect to any such Product during the Warranty Period, Company shall, in its sole discretion, either (i) repair or replace the Product; or (ii) credit or refund the price of Product provided that, if Company so requests, Customer shall, at Company's expense, return such Product to Company.

(d) **THE REMEDIES SET FORTH IN PARAGRAPH (c) SHALL BE THE CUSTOMER'S SOLE AND EXCLUSIVE REMEDY AND COMPANY'S ENTIRE LIABILITY FOR ANY BREACH OF THE LIMITED WARRANTY SET FORTH IN PARAGRAPH (a).**

Red Lion Controls
Headquarters
20 Willow Springs Circle
York PA 17406
Tel +1 (717) 767-6511
Fax +1 (717) 764-0839

Red Lion Controls
Europe
Softwareweg 9
NL - 3821 BN Amersfoort
Tel +31 (0) 334 723 225
Fax +31 (0) 334 893 793

Red Lion Controls
India
201-B, 2nd Floor, Park Centra
Opp 32 Mile Stone, Sector-30
Gurgaon-122002 Haryana, India
Tel +91 984 487 0503

Red Lion Controls
China
Unit 1102, XinMao Plaza
Building 9, No.99 Tianzhou Road
ShangHai, P.R. China 200223
Tel +86 21 6113 3688
Fax +86 21 6113 3683

PXU MODBUS REGISTER TABLE

09/04/2015

The following is an example of the necessary query and corresponding response for holding register 2. In this example register 2 is the decimal value 123.

Query: 01 03 00 01 00 01 D5 CA

Response: 01 03 02 00 7B F8 67

Notes:

1. The PXU registers can be read as holding (4x) or input (3x) registers.
2. The PXU should not be powered down while parameters are being changed. Doing so may result in an in-complete write to the non-volatile memory and produce checksum errors.

REGISTER (4x)	REGISTER NAME	LOW LIMIT	HIGH LIMIT	FACTORY SETTING	ACCESS	COMMENTS
FREQUENTLY USED REGISTERS						
1	Process Value (PV)	N/A	N/A	N/A	Read Only	1 = 1 Display unit
2	Active Setpoint (SP)	-999	9999	0	Read/Write	1 = 1 Display unit
3	Setpoint 1 (SP1)	-999	9999	0	Read/Write	1 = 1 Display unit
4	Setpoint 2 (SP2)	-999	9999	0	Read/Write	1 = 1 Display unit
5	Setpoint Deviation	N/A	N/A	N/A	Read Only	1 = 1 Display unit
6	Alarm 1 Value	-999	9999	100	Read/Write	1 = 1 Display unit
7	Alarm 2 Value	-999	9999	200	Read/Write	1 = 1 Display unit
8	Alarm 3 Value	-999	9999	300	Read/Write	1 = 1 Display unit
9	Output Power 1	0	1000	0	Read/Write	1 = 0.1%; writable when in manual mode only.
10	Output Power 2	0	1000	0	Read/Write	1 = 0.1%; writable when in manual mode only.
11	PB Proportional band (Active)	1	999(.9) ^o or 9999 (process)	70	Read/Write	1 = 1 Display unit
12	Integral time (Active)	0	9999	120	Read/Write	1 = 1 second
13	Derivative time (Active)	0	9999	30	Read/Write	1 = 1 second
14	Integration default (Active)	0	1000	0	Read/Write	1 = 0.1 % output power
15	PID parameter set selection	0	1	0	Read/Write	0 = PID Set 1, 1 = PID Set 2
16	Auto-Tune Start	0	1	0	Read/Write	0 = No; 1 = Yes
17	Control Mode Transfer (Auto/Manual)	0	1	0	Read/Write	0 = Automatic (PID), 1 = User (Manual Mode)
18	Controller Status	0	1	1	Read/Write	0: Stop, 1: Run
19	Setpoint Select	0	1	0	Read/Write	0 = SP1, 1 = SP2
20	SP Ramp Rate	0	999(.9) ^o or 9999 (process)	0	Read/Write	1 = 1 Display unit/minute; 0 = Ramping disabled
21	LED Status	N/A	N/A	N/A	Read Only	Bit State: 0 = Off, 1 = On b7: AT, b6: OUT1, b5: OUT2, b4: ALM1, b3: °C, b2: °F, b1: ALM2, b0: ALM3
22	Pushbutton Status	N/A	N/A	N/A	Read Only	Bit State: 0 = Key pressed, 1 = Key not pressed b7: D, b6: Up, b5: F1, b4: N/A, b3: P, b2: Down, b1: F2, b0: N/A
23	Alarm Reset	0	7	0	Read/Write	Bit State: 1 = reset alarm, bit is returned to zero following reset b3: Reset Alm3, b1: Reset Alm2, b0: Reset Alm1
24	Setpoint Ramping Disable	0	1	0	Read/Write	0 = Enabled, 1 = Disabled
25	Integral Action Disable	0	1	0	Read/Write	0 = Enabled, 1 = Disabled
PID PARAMETERS						
33	Proportional band 1	1	999(.9) ^o or 9999 (process)	70	Read/Write	1 = 1 Display unit
34	Integral time 1	0	9999	120	Read/Write	1 = 1 second
35	Derivative time 1	0	9999	30	Read/Write	1 = 1 second
36	Integration default 1	0	1000	0	Read/Write	1 = 0.1 %
37	Proportional band 2	1	999(.9) ^o or 9999 (process)	70	Read/Write	1 = 1 Display unit
38	Integral time 2	0	9999	120	Read/Write	1 = 1 second
39	Derivative time 2	0	9999	30	Read/Write	1 = 1 second
40	Integration default 2	0	1000	0	Read/Write	1 = 0.1 %
41	Output Power Offset	0	1000	500	Read/Write	1 = 0.1 % output power

REGISTER (4x)	REGISTER NAME	LOW LIMIT	HIGH LIMIT	FACTORY SETTING	ACCESS	COMMENTS
INPUT PARAMETERS						
51	Input Type	0	19	1	Read/Write	0 = tc-K 1 = tc-J 2 = tc-t 3 = tc-E 4 = tc-N 5 = tc-r 6 = tc-S 7 = tc-b 8 = tc-L 9 = tc-U 10 = tc-txk 11 = r392 12 = r385 13 = n1 14 = cu50 15 = 5v 16 = 10v 17 = 0-20mA 18 = 4-20mA 19 = 0.05v
52	Temperature Scale	0	1	0	Read/Write	0 = °F, 1 = °C
53	Decimal Resolution	0	3	0	Read/Write	0 = 0 (No decimal place) 1 = 0.0, 2 = 0.00, 3 = 0.000. Temperature inputs are limited to 1 decimal point except for the thermocouple B,S,R types, which display in whole units only (0)
54	Digital Filtering	0	50	8	Read/Write	0 = least, 50 = most
55	Input Filter Band	0	25(.0)° or 250 (process)	1	Read/Write	1 = 1 Display unit
56	Shift/Offset	-99(.9)° or 999 (process)	99(.9)° or 999 (process)	0	Read/Write	1 = 1 Display unit
57	Display Value Scaling Point 1	-999	9999	0	Read/Write	1 = 1 Display unit; Value associated with lower range of input signal (0V, 0mA or 4mA)
58	Display Value Scaling Point 2	-999	9999	1000	Read/Write	1 = 1 Display unit; Value associated with upper limit of input signal (50mV, 5V, 10V, or 20mA)
59	Setpoint Low Limit	depending on sensor type	Upper-limit of temperature range	-148	Read/Write	1 = 1 Display unit
60	Setpoint High Limit	Lower-limit of temperature range	Depends on sensor type	2192	Read/Write	1 = 1 Display unit
61	Cold Junction Compensation	0	1	0	Read/Write	0 = ON, 1 = OFF
62	User Input 1 Function	0	9 or 10	0	Read/Write	0 = NONE, 1 = Run/Stop, 2 = Setpoint 1/2 select, 3 = Auto/Manual control, 4 = PLOC, 5 = Integral Lock, 6 = SP Ramp Disable, 7 = Reset Alarms, 8 = Rst Alm1, 9 = Rst Alm2, 10 = Rst Alm3
63	User Input 2 Function	0	9 or 10	0	Read/Write	0 = NONE, 1 = Run/Stop, 2 = Setpoint 1/2 select, 3 = Auto/Manual control, 4 = PLOC, 5 = Integral Lock, 6 = SP Ramp Disable, 7 = Reset Alarms, 8 = Rst Alm1, 9 = Rst Alm2, 10 = Rst Alm3
64	F1 Key Function	0	6 or 7	0	Read/Write	0 = NONE, 1 = Run/Stop, 2 = Setpoint 1/2 select, 3 = Auto/Manual control, 4 = Reset Alarms, 5 = Rst Alm1, 6 = Rst Alm2, 7 = Rst Alm3
65	F2 Key Function	0	6 or 7	0	Read/Write	0 = NONE, 1 = Run/Stop, 2 = Setpoint 1/2 select, 3 = Auto/Manual control, 4 = Reset Alarms, 5 = Rst Alm1, 6 = Rst Alm2, 7 = Rst Alm3
OUTPUT PARAMETERS						
81	Output Action	0	1 or 5	0	Read/Write	Single Output Model: 0 = r1, 1 = d1; Dual Output Model: 0 = r1r2, 1 = d1r2, 2 = r1d2, 3 = d1d2, 4 = r1A2, 5 = d1A2 r = reverse acting, d = direct acting, A = Alarm 3, numeric value indicates OP1 or OP2,
82	Auto Control Mode	0	1	0	Read/Write	0 = PID, 1 = On-Off
83	Output 1 Cycle Time	0	250	20	Read/Write	1 = 0.1 sec; A setting of zero will keep output off.
84	Output 1 Power Lower Limit	0	Output 1 Power High Limit	0	Read/Write	1 = 0.1 %
85	Output 1 Power High Limit	Output 1 Power Lower Limit	1000	1000	Read/Write	1 = 0.1 %
86	Input Fail OP1 Power Level	0	1000	0	Read/Write	1 = 0.1 %
87	Analog Out 1 Low Scaling Value	-999	9999	0	Read/Write	1 = 0.1 %
88	Analog Out 1 High Scaling Value	-999	9999	1000	Read/Write	1 = 0.1 %
89	Reserved			0		
90	Reserved			0		
91	Output 2 Cycle Time	0	250	20	Read/Write	1 = 0.1 sec; A setting of zero will keep output off.
92	Output 2 Power Lower Limit	0	Output 2 Power High Limit	0	Read/Write	1 = 0.1 %
93	Output 2 Power High Limit	Output 2 Power Lower Limit	1000	1000	Read/Write	1 = 0.1 %
94	Input Fail OP2 Power Level	0	1000	0	Read/Write	1 = 0.1 %
95	Relative Gain	1	9999	100	Read/Write	1 = 0.01; In combination Reverse(r) and Direct(d) modes, this defines the gain of OP2 relative to OP1.

REGISTER (4x)	REGISTER NAME	LOW LIMIT	HIGH LIMIT	FACTORY SETTING	ACCESS	COMMENTS
96	Deadband/Overlap	-99(.9) or -999 (process)	999(.9)° or 9999 (process)	2	Read/Write	1 = 1 Display unit; In combination Reverse(r) and Direct(d) modes, this defines the overlap area in which both OP1 and OP2 are active (negative value) or the deadband area (positive value).
97	On/Off Control Hysteresis	2	250(.0)° or 2500 (process)	2	Read/Write	1 = 1 Display unit
LOCKOUT PARAMETERS						
101	Setpoint Access	0	4	0	Read/Write	0 = dISP, 1 = ParA, 2 = HIdE, 3 = LOC, 4 = dSPr
102	Output 1 Power Access	0	4	1	Read/Write	0 = dISP, 1 = ParA, 2 = HIdE, 3 = LOC, 4 = dSPr
103	Output 2 Power Access	0	4	1	Read/Write	0 = dISP, 1 = ParA, 2 = HIdE, 3 = LOC, 4 = dSPr
104	Setpoint Ramp Rate Access	0	4	1	Read/Write	0 = dISP, 1 = ParA, 2 = HIdE, 3 = LOC, 4 = dSPr
105	PID Group Access	0	4	1	Read/Write	0 = dISP, 1 = ParA, 2 = HIdE, 3 = LOC, 4 = dSPr
106	Controller Status (Run/Stop) Access	0	4	0	Read/Write	0 = dISP, 1 = ParA, 2 = HIdE, 3 = LOC, 4 = dSPr
107	Output Power Offset Access	1	3	1	Read/Write	1 = ParA, 2 = HIdE, 3 = LOC
108	Proportional band Access	1	3	1	Read/Write	1 = ParA, 2 = HIdE, 3 = LOC
109	Integral time Access	1	3	1	Read/Write	1 = ParA, 2 = HIdE, 3 = LOC
110	Derivative time Access	1	3	1	Read/Write	1 = ParA, 2 = HIdE, 3 = LOC
111	Integration Default Access	1	3	3	Read/Write	1 = ParA, 2 = HIdE, 3 = LOC
112	Alarm 1 Value Access	1	3	1	Read/Write	1 = ParA, 2 = HIdE, 3 = LOC
113	Alarm 2 Value Access	1	3	1	Read/Write	1 = ParA, 2 = HIdE, 3 = LOC
114	Alarm 3 Value Access	1	3	1	Read/Write	1 = ParA, 2 = HIdE, 3 = LOC
115	Alarm Reset Access	1	3	1	Read/Write	1 = ParA, 2 = HIdE, 3 = LOC
116	Setpoint Select Access	1	3	1	Read/Write	1 = ParA, 2 = HIdE, 3 = LOC
117	Auto-Tune Start Access	2	3	2	Read/Write	2 = HIdE, 3 = LOC
118	Auto Control Mode Access	2	3	2	Read/Write	2 = HIdE, 3 = LOC
119	Control Mode Transfer Access	2	3	2	Read/Write	2 = HIdE, 3 = LOC
120	Deviation Value Access	0	3	0	Read/Write	0 = dISP, 3 = LOC
121	Access Code	-125	125	0	Read/Write	0 = Full access to display, parameter, hidden, and configuration loops; -1 to -125 = Code necessary to access configuration loop only; 1 to 125 = Code necessary to access hidden and configuration loops
ALARM PARAMETERS						
131	Alarm 1 Action	0	18	0	Read/Write	0 = No, 1 = AbHI, 2 = AbLO, 3 = AUHI, 4 = AULO, 5 = d-HI, 6 = d-Lo, 7 = b-In, 8 = b-ot, 9 = InPt, 10 = Ct1, 11 = Ct2, 12 = SOAK, 13 = r-UP, 14 = r-dn, 15 = rUn, 16 = HoLd, 17 = StoP, 18 = End
132	Alarm 1 Annunciator	0	1	0	Read/Write	0 = Normal, 1 = Reverse
133	Alarm 1 Reset Mode	0	1	0	Read/Write	0 = Automatic, 1 = Latched
134	Alarm 1 Standby	0	1	0	Read/Write	0 = No, 1 = Yes
135	Alarm 1 Value	-999	9999	100	Read/Write	1 = 1 Display unit
136	Input Fail Alarm 1 Action	0	1	0	Read/Write	0 = Off; 1 = On
137	Alarm 2 Action	0	18	0	Read/Write	0 = No, 1 = AbHI, 2 = AbLO, 3 = AUHI, 4 = AULO, 5 = d-HI, 6 = d-Lo, 7 = b-In, 8 = b-ot, 9 = InPt, 10 = Ct1, 11 = Ct2, 12 = SOAK, 13 = r-UP, 14 = r-dn, 15 = rUn, 16 = HoLd, 17 = StoP, 18 = End
138	Alarm 2 Annunciator	0	1	0	Read/Write	0 = Normal, 1 = Reverse
139	Alarm 2 Reset Mode	0	1	0	Read/Write	0 = Automatic, 1 = Latched
140	Alarm 2 Standby	0	1	0	Read/Write	0 = No, 1 = Yes
141	Alarm 2 Value	-999	9999	200	Read/Write	1 = 1 Display unit
142	Input Fail Alarm 2 Action	0	1	0	Read/Write	0 = Off; 1 = On
143	Alarm 3 Action	0	18	0	Read/Write	0 = No, 1 = AbHI, 2 = AbLO, 3 = AUHI, 4 = AULO, 5 = d-HI, 6 = d-Lo, 7 = b-In, 8 = b-ot, 9 = InPt, 10 = Ct1, 11 = Ct2, 12 = SOAK, 13 = r-UP, 14 = r-dn, 15 = rUn, 16 = HoLd, 17 = StoP, 18 = End
144	Alarm 3 Annunciator	0	1	0	Read/Write	0 = Normal, 1 = Reverse
145	Alarm 3 Reset Mode	0	1	0	Read/Write	0 = Automatic, 1 = Latched
146	Alarm 3 Standby	0	1	0	Read/Write	0 = No, 1 = Yes
147	Alarm 3 Value	-999	9999	300	Read/Write	1 = 1 Display unit

REGISTER (4x)	REGISTER NAME	LOW LIMIT	HIGH LIMIT	FACTORY SETTING	ACCESS	COMMENTS
148	Input Fail Alarm 3 Action	0	1	0	Read/Write	0 = Off, 1 = On
149	Alarm Hysteresis	0	250(.0) ^o or 2500 (process)	0	Read/Write	1 = 1 Display unit; The same value applies to all alarms.
150	Change Color Intensity	0	4	0	Read/Write	0 = OFF, 1 = Any Alarm, 2 = AL-1, 3 = AL-2, 4 = AL-3
SERIAL COMMUNICATION PARAMETERS						
211	Communications Type	0	1	1	Read/Write	0 = ASCII, 1 = rTU
212	Baud Rate	0	4	4	Read/Write	0 = 2400, 1 = 4800, 2 = 9600, 3 = 19200, 4 = 38400
213	Data Bit	7	8	1	Read/Write	0 = 7, 1 = 8
214	Parity Bit	0	2	0	Read/Write	0 = No, 1 = Even, 2 = Odd
215	Unit Address	1	247	247	Read/Write	
216	Load Serial Settings	0	1	0	Write *	0 = No change, 1 = Load Serial Settings; * - will read 0
SLAVE ID						
1001		N/A	N/A	0x524C ("RL")	Read Only	0x524C ("RL")
1002		N/A	N/A	0x432D ("C-")	Read Only	0x432D ("C-")
1003		N/A	N/A	0x5058 ("PX")	Read Only	0x5058 ("PX")
1004		N/A	N/A	model dependent	Read Only	0x55<n> ("Un") 'n' - 1st output; '0' (0x30) = No Card installed, 'x' (0x78) = any output option card installed
1005		N/A	N/A	model dependent	Read Only	0x<c>(2nd Output): '0' (0x30) = No Card installed, 'x' (0x78) = any output option card installed <c>(Options): '9' = RS485/No User Inputs, 'A' = RS485/2 User Inputs
1006		N/A	N/A	0x2020 (" ")	Read Only	0x2020 (" ")
1007		N/A	N/A		Read Only	0x0100 = Software database version number in BCD (0x0100 = 1.00)
1008		N/A	N/A	0x10	Read Only	0x10 = 16 reads
1009		N/A	N/A	0x10	Read Only	0x10 = 16 writes
1010		N/A	N/A	0	Read Only	