

Silicon Switching Diode

- For high-speed switching applications
- Pb-free (RoHS compliant) package ¹⁾
- Qualified according AEC Q101

BAS16
BAS16W
BAS16-02L
BAS16-02V
BAS16-02W
BAS16-03W
BAS16S
BAS16U
BAS16-07L4

Type	Package	Configuration	Marking
BAS16	SOT23	single	A6s
BAS16-02L*	TSLP-2-1	single, leadless	A6
BAS16-02V	SC79	single	6
BAS16-02W	SCD80	single	A6
BAS16-03W	SOD323	single	white B
BAS16-07L4*	TSLP-4-4	parallel pair, leadless	6A
BAS16S	SOT363	parallel triple	A6s
BAS16U	SC74	parallel triple	A6s
BAS16W	SOT323	single	A6s

* Preliminary Data

¹Pb-containing package may be available upon special request

Maximum Ratings at $T_A = 25\text{ °C}$, unless otherwise specified

Parameter	Symbol	Value	Unit
Diode reverse voltage	V_R	80	V
Peak reverse voltage	V_{RM}	85	
Forward current	I_F		mA
BAS16		250	
BAS16-02L, -07L4		200	
BAS16-02V, -02W		200	
BAS16-03W		250	
BAS16S		200	
BAS16U		200	
BAS16W		250	
Non-repetitive peak surge forward current	I_{FSM}		A
$t = 1\ \mu\text{s}$, BAS16/ S/ U/ W/ -03W		4.5	
$t = 1\ \mu\text{s}$, BAS16-02L/ -02V/ -02W/ -07L4		2.5	
$t = 1\ \text{s}$		0.5	
Total power dissipation	P_{tot}		mW
BAS16, $T_S \leq 54\text{ °C}$		370	
BAS16-02L, -07L4, $T_S \leq 130\text{ °C}$		250	
BAS16-02V, -02W, $T_S \leq 120\text{ °C}$		250	
BAS16-03W, $T_S \leq 116\text{ °C}$		250	
BAS16S, $T_S \leq 85\text{ °C}$		250	
BAS16U, $T_S \leq 113\text{ °C}$		250	
BAS16W, $T_S \leq 119\text{ °C}$		250	
Junction temperature	T_j	150	°C
Storage temperature	T_{stg}	-65 ... 150	

Thermal Resistance

Parameter	Symbol	Value	Unit
Junction - soldering point ¹⁾	R_{thJS}		K/W
BAS16, BAS16S		≤ 260	
BAS16-02L, -07L4		≤ 80	
BAS16-02V, -02W		≤ 120	
BAS16-03W		≤ 135	
BAS16U		≤ 150	
BAS16W		≤ 125	

Electrical Characteristics at $T_A = 25^\circ\text{C}$, unless otherwise specified

Parameter	Symbol	Values			Unit
		min.	typ.	max.	
DC Characteristics					
Breakdown voltage $I_{(BR)} = 100 \mu\text{A}$	$V_{(BR)}$	85	-	-	V
Reverse current $V_R = 75 \text{ V}$ $V_R = 25 \text{ V}, T_A = 150^\circ\text{C}$ $V_R = 75 \text{ V}, T_A = 150^\circ\text{C}$	I_R	-	-	1 30 50	μA
Forward voltage $I_F = 1 \text{ mA}$ $I_F = 10 \text{ mA}$ $I_F = 50 \text{ mA}$ $I_F = 100 \text{ mA}$ $I_F = 150 \text{ mA}$	V_F	-	-	715 855 1000 1200 1250	mV
Forward recovery voltage $I_F = 10 \text{ mA}, t_P = 20 \text{ ns}$	V_{fr}	-	-	1.75	V

¹⁾For calculation of R_{thJA} please refer to Application Note Thermal Resistance

Electrical Characteristics at $T_A = 25^\circ\text{C}$, unless otherwise specified

Parameter	Symbol	Values			Unit
		min.	typ.	max.	
AC Characteristics					
Diode capacitance $V_R = 0\text{ V}$, $f = 1\text{ MHz}$	C_T	-	-	2	pF
Reverse recovery time $I_F = 10\text{ mA}$, $I_R = 10\text{ mA}$, measured at $I_R = 1\text{ mA}$, $R_L = 100\ \Omega$	t_{rr}	-	-	4	ns

Test circuit for reverse recovery time

Pulse generator: $t_p = 100\text{ ns}$, $D = 0.05$, $t_r = 0.6\text{ ns}$,
 $R_i = 50\ \Omega$

Oscilloscope: $R = 50\ \Omega$, $t_r = 0.35\text{ ns}$, $C = 0.05\text{ pF}$

Reverse current $I_R = f(T_A)$

$V_R =$ Parameter



Forward Voltage $V_F = f(T_A)$

$I_F =$ Parameter

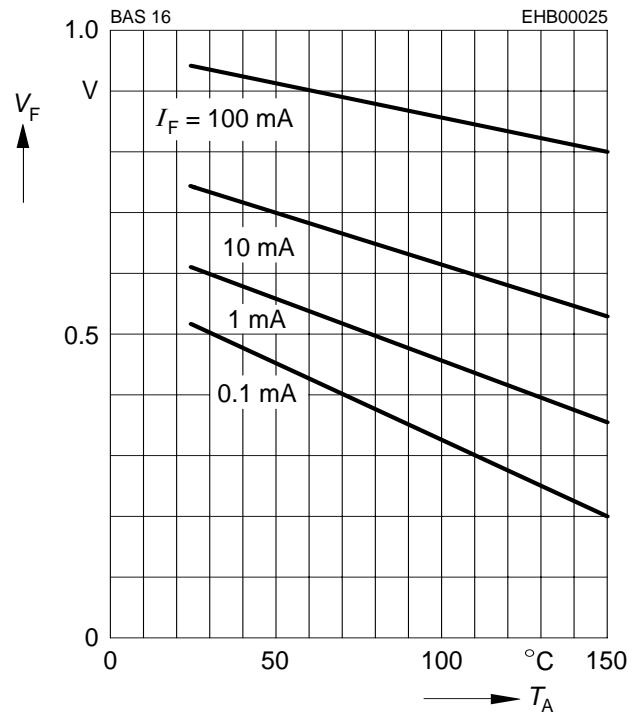

Forward current $I_F = f(V_F)$

$T_A = 25^\circ\text{C}$



Forward current $I_F = f(T_S)$

BAS16

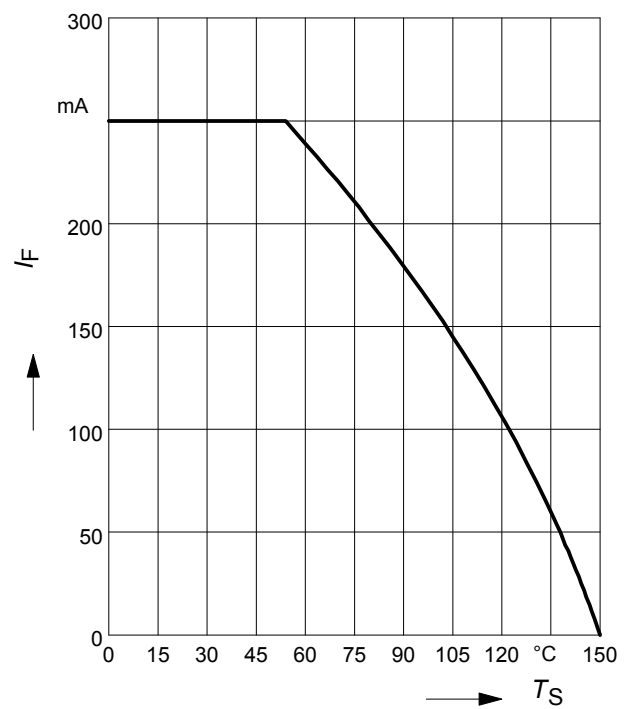

Forward current $I_F = f(T_S)$

BAS16-02L, -07L4



Forward current $I_F = f(T_S)$

BAS16-02V, -02W



Forward current $I_F = f(T_S)$

BAS16-03W



Forward current $I_F = f(T_S)$

BAS16S



Forward current $I_F = f(T_S)$

BAS16U



Forward current $I_F = f(T_S)$

BAS16W



Permissible Puls Load $R_{thJS} = f(t_p)$

BAS16



Permissible Pulse Load

$I_{Fmax} / I_{FDC} = f(t_p)$

BAS16



Permissible Puls Load $R_{thJS} = f(t_p)$

BAS16-02L, -07L4



Permissible Pulse Load

$I_{Fmax} / I_{FDC} = f(t_p)$

BAS16-02L, -07L4



Permissible Puls Load $R_{thJS} = f(t_p)$

BAS16-02V, -02W



Permissible Pulse Load

$I_{Fmax} / I_{FDC} = f(t_p)$

BAS16-02V, -02W



Permissible Puls Load $R_{thJS} = f(t_p)$

BAS16-03W



Permissible Pulse Load

$I_{Fmax} / I_{FDC} = f(t_p)$

BAS16-03W



Permissible Puls Load $R_{thJS} = f(t_p)$

BAS16S

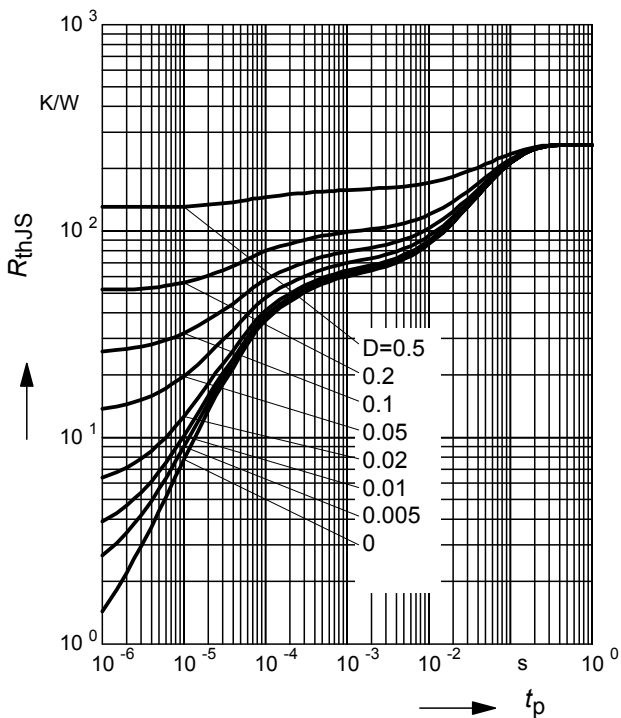

Permissible Pulse Load

$I_{Fmax} / I_{FDC} = f(t_p)$

BAS16S

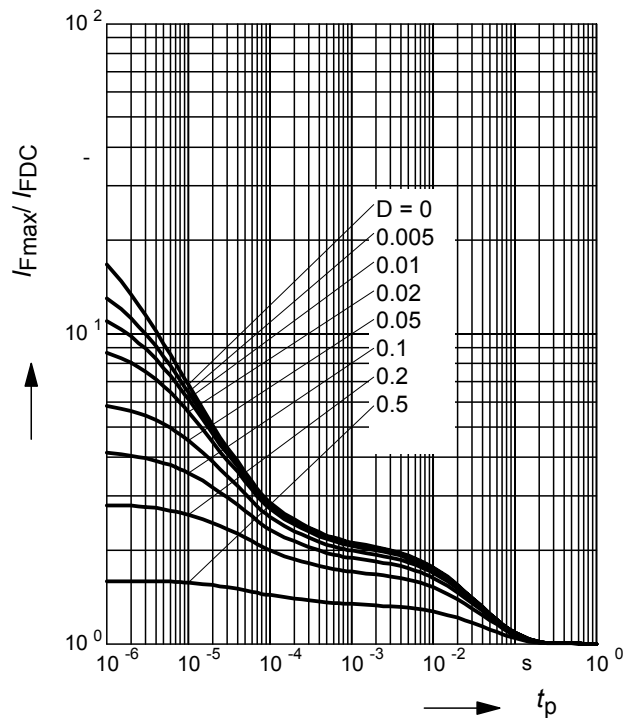

Permissible Puls Load $R_{thJS} = f(t_p)$

BAS16U

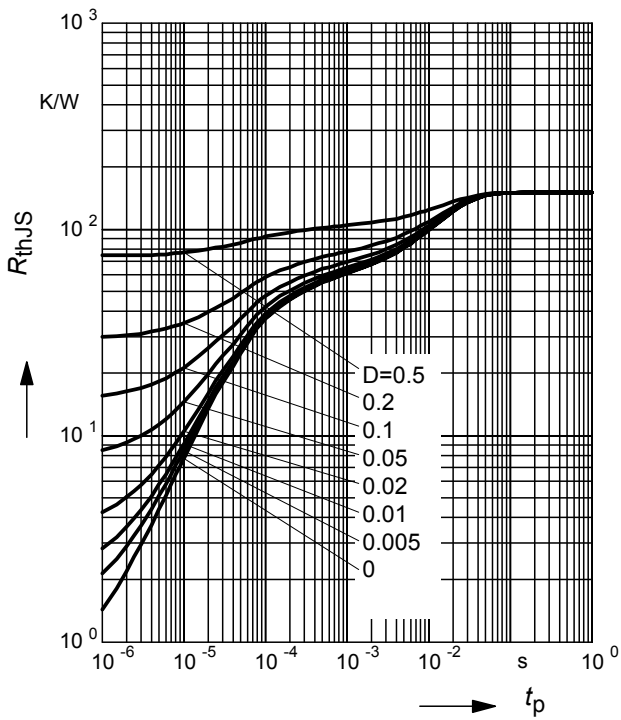

Permissible Pulse Load

$I_{Fmax} / I_{FDC} = f(t_p)$

BAS16U

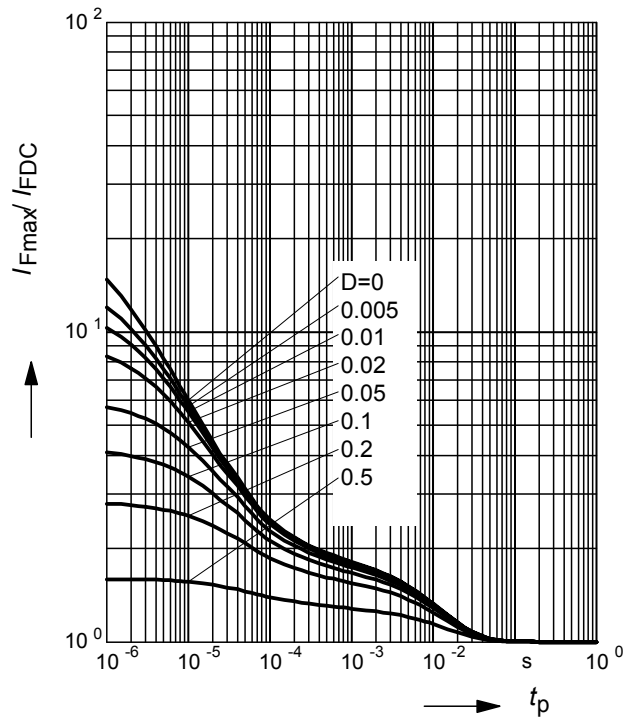

Permissible Puls Load $R_{thJS} = f(t_p)$

BAS16W



Permissible Pulse Load

$I_{Fmax} / I_{FDC} = f(t_p)$

BAS16W



Package Outline

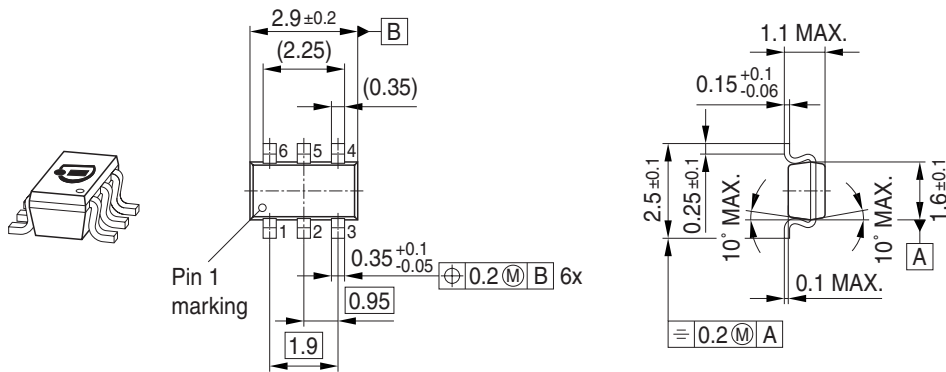

Foot Print

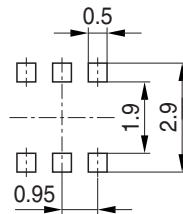

Marking Layout (Example)

Small variations in positioning of Date code, Type code and Manufacture are possible.



Standard Packing

Reel \varnothing 180 mm = 3.000 Pieces/Reel
 Reel \varnothing 330 mm = 10.000 Pieces/Reel

For symmetric types no defined Pin 1 orientation in reel.



Package Outline



Foot Print



Marking Layout (Example)

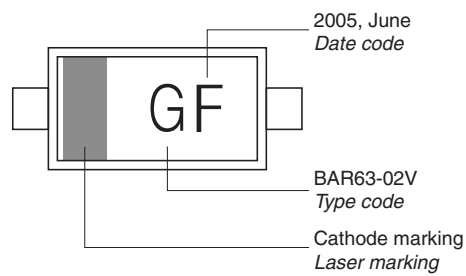

Standard Packing

Reel ø180 mm = 3.000 Pieces/Reel
 Reel ø180 mm = 8.000 Pieces/Reel (2 mm Pitch)
 Reel ø330 mm = 10.000 Pieces/Reel

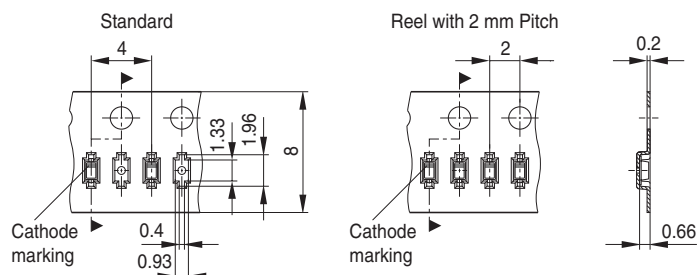

Package Outline

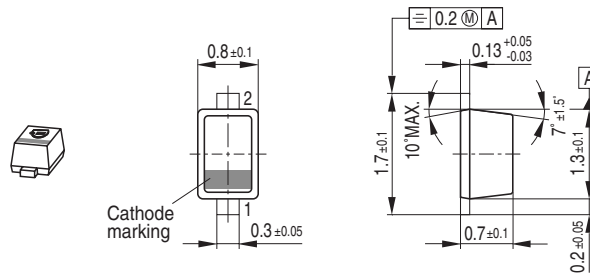

Foot Print



Marking Layout (Example)

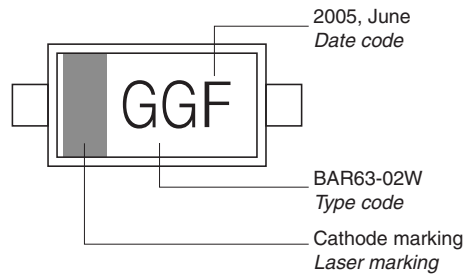

Standard Packing

Reel \varnothing 180 mm = 3.000 Pieces/Reel
 Reel \varnothing 180 mm = 8.000 Pieces/Reel (2 mm Pitch)
 Reel \varnothing 330 mm = 10.000 Pieces/Reel

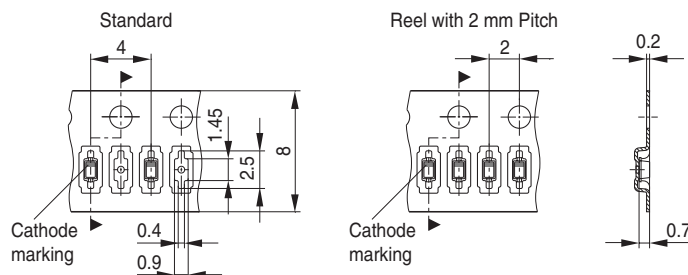

Date Code marking for discrete packages with one digit (SCD80, SC79, SC75¹⁾) CES-Code

Month	2003	2004	2005	2006	2007	2008	2009	2010	2011	2012	2013	2014
01	a	p	A	P	a	p	A	P	a	p	A	P
02	b	q	B	Q	b	q	B	Q	b	q	B	Q
03	c	r	C	R	c	r	C	R	c	r	C	R
04	d	s	D	S	d	s	D	S	d	s	D	S
05	e	t	E	T	e	t	E	T	e	t	E	T
06	f	u	F	U	f	u	F	U	f	u	F	U
07	g	v	G	V	g	v	G	V	g	v	G	V
08	h	x	H	X	h	x	H	X	h	x	H	X
09	j	y	J	Y	j	y	J	Y	j	y	J	Y
10	k	z	K	Z	k	z	K	Z	k	z	K	Z
11	l	2	L	4	l	2	L	4	l	2	L	4
12	n	3	N	5	n	3	N	5	n	3	N	5

1) New Marking Layout for SC75, implemented at October 2005.

Package Outline

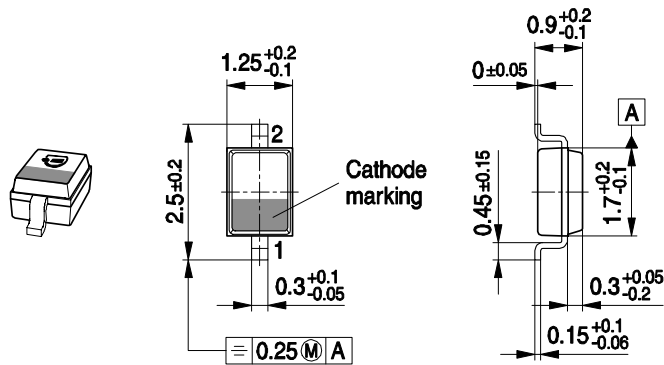

Foot Print



Marking Layout (Example)

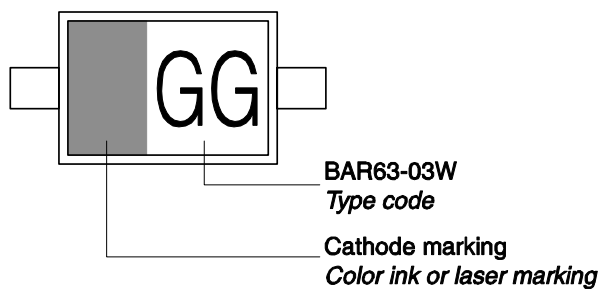

Standard Packing

Reel \varnothing 180 mm = 3.000 Pieces/Reel
 Reel \varnothing 330 mm = 10.000 Pieces/Reel

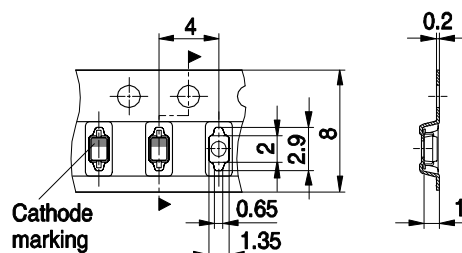

Package Outline

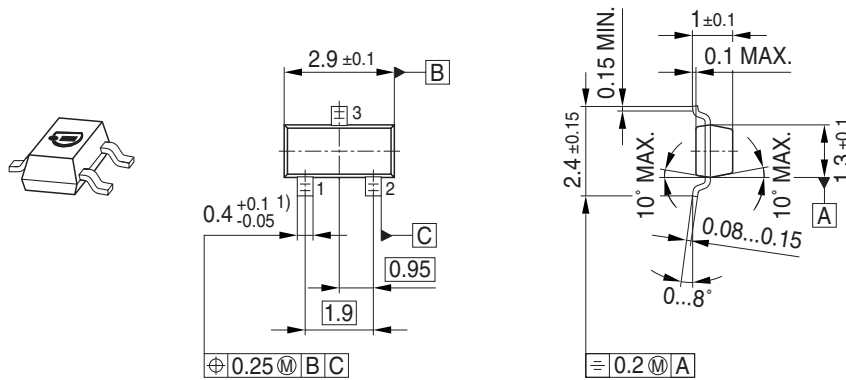

1) Lead width can be 0.6 max. in dambar area

Foot Print

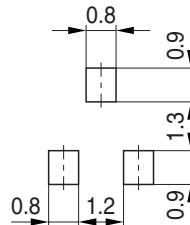

Marking Layout (Example)



Standard Packing

Reel \varnothing 180 mm = 3.000 Pieces/Reel
 Reel \varnothing 330 mm = 10.000 Pieces/Reel



Package Outline



Foot Print



Marking Layout (Example)



Standard Packing

Reel \varnothing 180 mm = 3.000 Pieces/Reel
 Reel \varnothing 330 mm = 10.000 Pieces/Reel



Package Outline



1) Dimension applies to plated terminal

Foot Print

For board assembly information please refer to Infineon website "Packages"



■ Copper □ Solder mask

▨ Stencil apertures

Marking Layout (Example)



BAS16-02L
Type code

Cathode marking
Laser marking

Standard Packing

Reel \varnothing 180 mm = 15.000 Pieces/Reel
Reel \varnothing 330 mm = 50.000 Pieces/Reel (optional)



Edition 2006-02-01

Published by

Infineon Technologies AG

81726 München, Germany

© Infineon Technologies AG 2007.

All Rights Reserved.

Attention please!

The information given in this dokument shall in no event be regarded as a guarantee of conditions or characteristics ("Beschaffenheitsgarantie"). With respect to any examples or hints given herein, any typical values stated herein and/or any information regarding the application of the device, Infineon Technologies hereby disclaims any and all warranties and liabilities of any kind, including without limitation warranties of non-infringement of intellectual property rights of any third party.

Information

For further information on technology, delivery terms and conditions and prices please contact your nearest Infineon Technologies Office (www.infineon.com).

Warnings

Due to technical requirements components may contain dangerous substances. For information on the types in question please contact your nearest Infineon Technologies Office.

Infineon Technologies Components may only be used in life-support devices or systems with the express written approval of Infineon Technologies, if a failure of such components can reasonably be expected to cause the failure of that life-support device or system, or to affect the safety or effectiveness of that device or system.

Life support devices or systems are intended to be implanted in the human body, or to support and/or maintain and sustain and/or protect human life. If they fail, it is reasonable to assume that the health of the user or other persons may be endangered.