

SWITCH FUNCTION	
POS. 1	POS. 2
ON	(ON)
1-3	1-2

(ON) = MOMENTARY

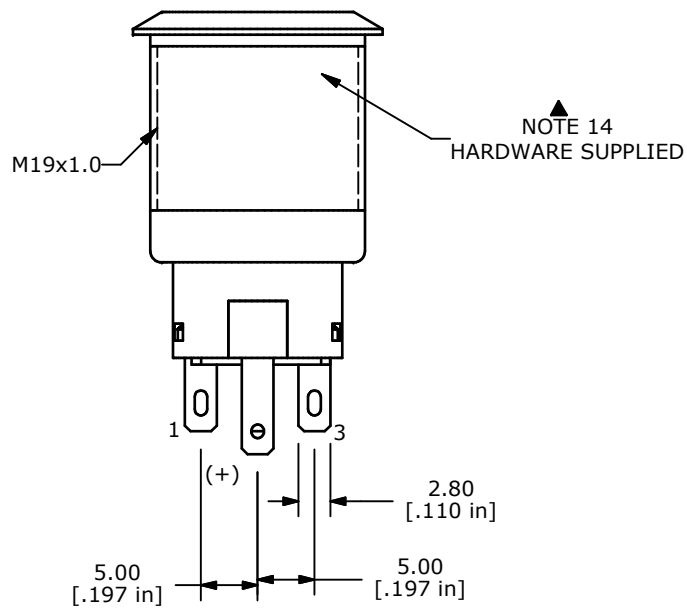

- NOTE:
- ALL DIMENSIONS IN MM [INCH]
 - GENERAL TOLERANCE: X.X=±0.4
X.XX=±0.25
 - TERMINAL NUMBERS FOR REF ONLY
 - CONTACT MATERIAL: SILVER
 - RATING: 2A 48VDC
 - ELECTRIC LIFE: 50,000 MAKE-AND-BREAK CYCLES AT FULL LOAD.
 - INSULATION RESISTANCE: 1,000 MΩ MIN.
 - DIELECTRIC STRENGTH: 2,000 VAC MIN. FOR 1 MINUTE
 - CONTACT RESISTANCE: 50mΩ MAX. @ 1A 12VDC
 - OPERATING TEMP.: -20°C to 55°C
 - ▲ DENOTES CRITICAL PARAMETER.
 - LAMP VOLTAGE: 6V
 - INGRESS PROTECTION: IP65
 - HARDWARE SUPPLIED: O-RING AND HEXNUT
 - ILLUMINATION COLOR: BLUE
 - TRAVEL: 2.8mm

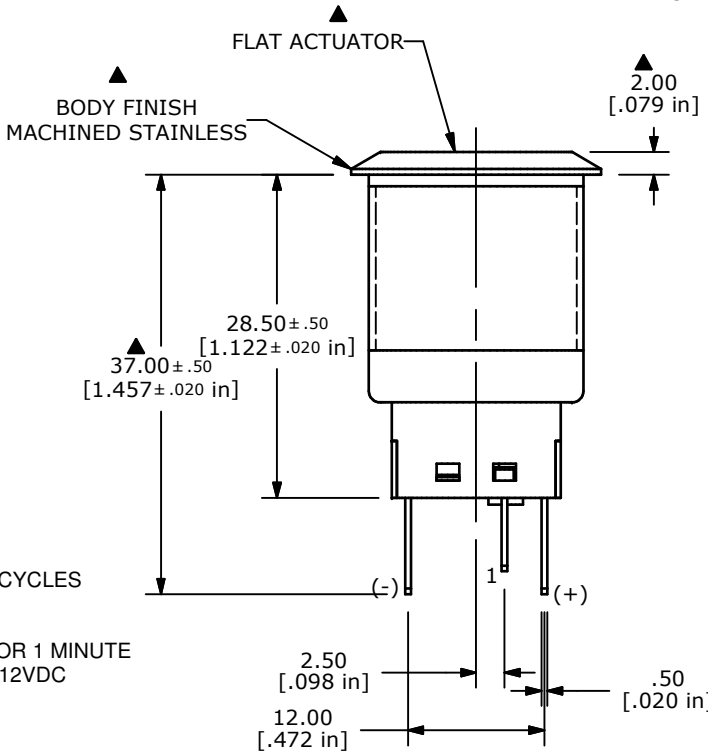
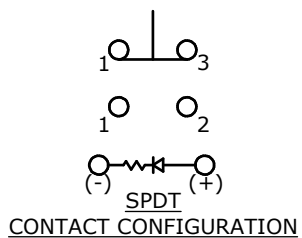
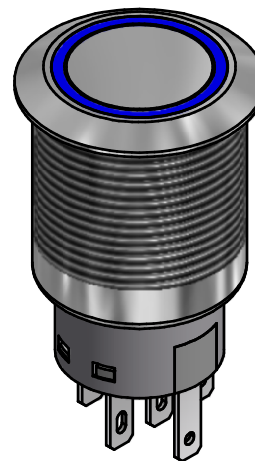
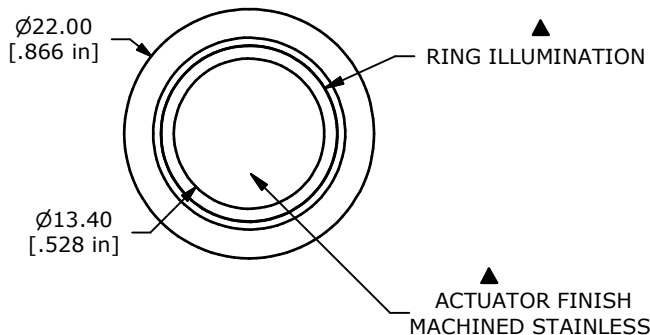

TITLE PV4F2B0SS-343				
SCALE	DATE 4/29/2013	DR EBP	DWG 52-PV4F2B0SS343	REV A

A	21117	RELEASE FOR PRODUCTION	4/29/13	EBP
REV	PCR NO	DESCRIPTION	DATE	BY

THE INFORMATION CONTAINED IN THIS DOCUMENT IS PROPRIETARY TO E-SWITCH AND IS NOT TO BE COPIED OR TRANSFERRED