

## Thunder click™

### 1. Introduction

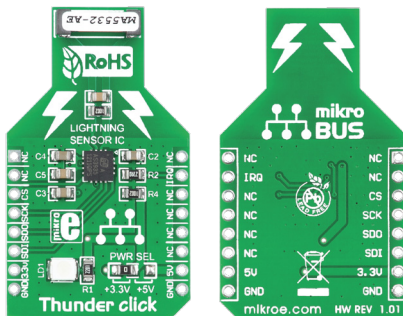

Thunder click™ is an accessory board in **mikroBUS™** form factor. It's a compact and easy solution for adding lightning sensor to your design. It features **AS3935** lightning sensor as well as **MA5532** coil antenna. Thunder click™ communicates with the target board microcontroller via **mikroBUS™** SPI (MOSI, MISO, SCK, CS) and INT lines. The board is designed to use 3.3V or 5V power supply. LED diode (GREEN) indicates the presence of power supply.

### 2. Soldering the headers

Before using your click™ board, make sure to solder 1x8 male headers to both left and right side of the board. Two 1x8 male headers are included with the board in the package.

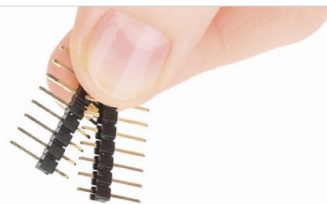

1

2

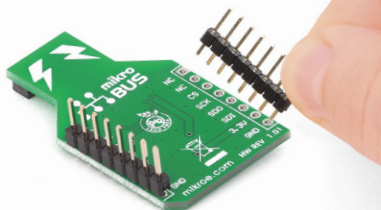

Turn the board upside down so that bottom side is facing you upwards. Place shorter pins of the header into the appropriate soldering pads.

3

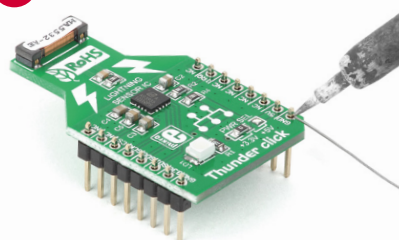

Turn the board upward again. Make sure to align the headers so that they are perpendicular to the board, then solder the pins carefully.

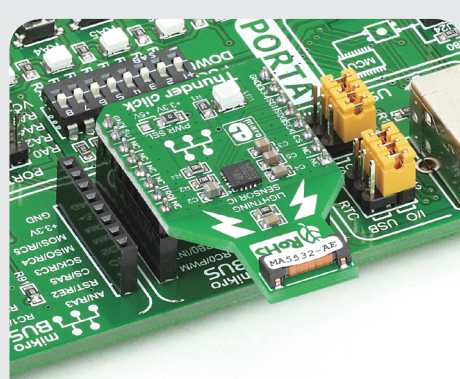

### 4. Essential features

Thunder click™ with its **AS3935** IC and **MA5532** coil antenna detects the presence and proximity of potentially hazardous lightning activity in the vicinity and provides estimated distance to the center of the storm. It can also provide information on the noise level. All these features make this board ideal for weather stations, sports equipment, pool safety, UPSs, GPSs, watches, cellular phones and many more.

### 3. Plugging the board in

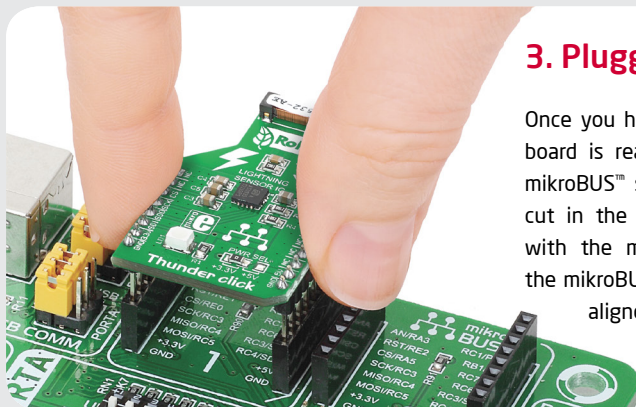

Once you have soldered the headers your board is ready to be placed into desired mikroBUS™ socket. Make sure to align the cut in the lower-right part of the board with the markings on the silkscreen at the mikroBUS™ socket. If all of the pins are aligned correctly, push the board all the way into the socket.

click™  
BOARD  
[www.mikroe.com](http://www.mikroe.com)



Thunder click Manual  
ver. 1.01



0 100000 024317

## 5. Thunder click™ Board Schematic

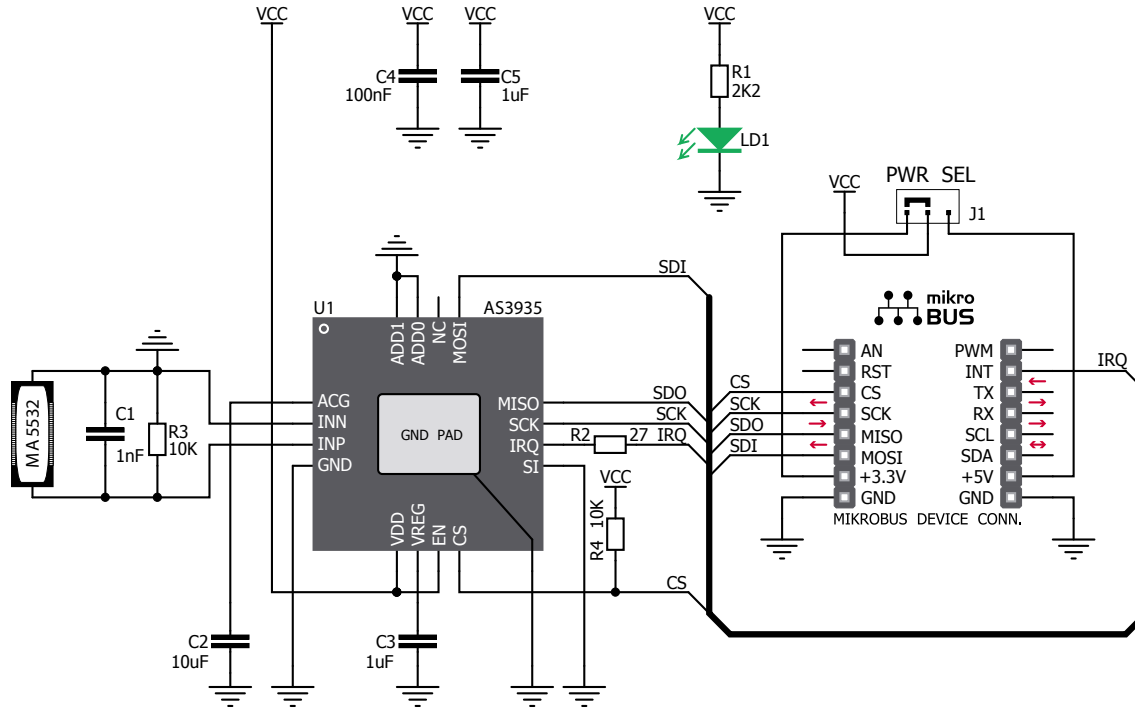

## 6. SMD Jumpers

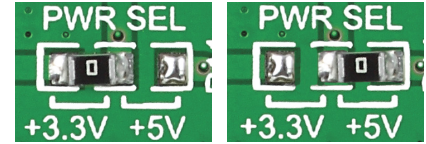

There is one zero-ohm SMD jumper **J1** used to select whether 3.3V or 5V power supply is used. Jumper **J1** is soldered in 3.3V position by default.

## 7. Code Examples

Once you have done all the necessary preparations, it's time to get your click™ board up and running. We have provided the examples for mikroC™, mikroBasic™ and mikroPascal™ compilers on our **Libstock** website. Just download them and you are ready to start.



## 8. Support

MikroElektronika offers **Free Tech Support** ([www.mikroe.com/esupport](http://www.mikroe.com/esupport)) until the end of product lifetime, so if something goes wrong, we are ready and willing to help!