

Approval Sheet

for

**Power Wirewound Resistors
Fibre Glass Core & Coated & Radial
Type**

PGM Series

$\pm 5\%$ & $\pm 10\%$

YAGEO CORPORATION

Headquarters: 3F, No.233-1, Pao Chiao Rd., Xindian, Taipei, Taiwan, R.O.C.

Tel: 886-2-6629-9999 **Fax:** 886-2-6628-8885

URL: www.yageo.com

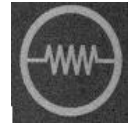

Rev.	Description	Issue Date	Drawn	Approved
00	issue new spec.	May 25, 2012	Feng Ye	Ken Hsu
01	Revised the letters on the maps	May 19, 2015	Feng Ye	Flora Shen
02	Marking is included	May 26, 2015	Feng Ye	Flora Shen

Description	Power Wirewound Resistors, Fibre Glass Core & Coated & Radial Type		
Series	PGM	Rev.	02

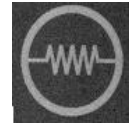

1. PRODUCT:

Power wirewound resistors, wound on fibre glass core, have a special internal direct contact to virtually eliminate resistance changes caused by varying , often high temperatures.

RADIAL TYPE
(PGM SERIES)

2. PART NUMBER:

Part number of the power wirewound resistor is identified by the name, power, tolerance, packing, temperature coefficient and resistance value.

Example :

PGM	400	J	B	-	0R47
(1)	(2)	(3)	(4)	(5)	(6)
Series	Power	Resistance	Packing	Temperature	Resistance
Name	Rating	Tolerance	Style	Coefficient	Value
				of Resistance	

(1) Style : PGM SERIES: Radial Type

(2) Power Rating : 200=2W 、 400=4W 、 500=5W 、 650=6.5W 、 800W=8W 、 2WS=2W 、 4WS=4W 、 5WS=5W 、 65S=6.5W 、 8WS=8W

(3) Tolerance : J = $\pm 5\%$ K = $\pm 10\%$

(4) Packaging Type : B = Bulk Packing

(5) Temperature Coefficient : “-“=base on spec.

(6) Resistance Value : $\pm 5\%$ for E24 Series
 $\pm 10\%$ for E12 Series

Example : 0R1, 0R47, 10R,10K

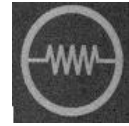

3. ELECTRICAL CHARACTERISTICS

STYLE	PGM200	PGM400	PGM500	PGM650	PGM800
	PGM2WS	PGM4WS	PGM5WS	PGM65S	PGM8WS
Power Rating at 70 °C	2W	4W	5W	6.5W	8W
Max. Cont. Work. Voltage	$\sqrt{P70 \times R}$				
Thermal resistance _{cv} (°C/W)	110	70	60	50	40
Resistance Range (Ω)	0R1~7K5	0R15~11K	0R27~20K	0R39~27K	0R47~36K
Tolerances	±10%	±10%	±10%	±10%	±10%
	±5% ≥ 0R2	±5% ≥ 0R3	±5% ≥ 0R47	±5% ≥ 0R68	±5% ≥ 0R91
Insulation Voltage (1min.)	Max. 75V				
Temperature Coefficient	-80~+500PPM/°C				
Operating Temp. Range	- 55 °C to + 350 °C				

4. DERATING CURVE

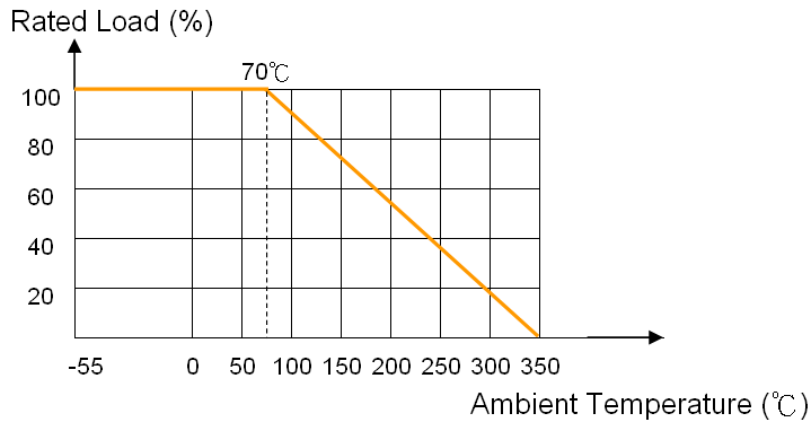

5. DIMENSIONS

Dimensions in mm

Type PGM200/400/500/650/800

Type PGM2WS/4WS/5WS/65S/8WS

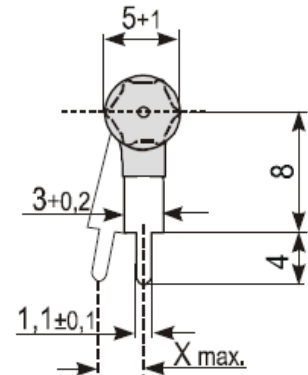
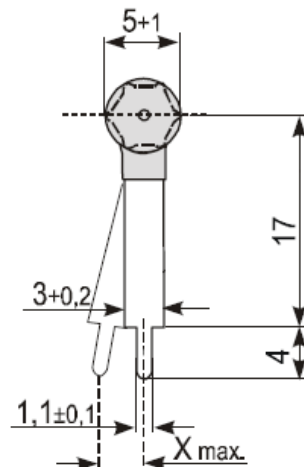
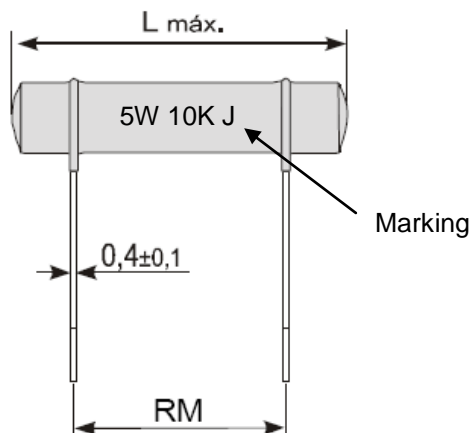

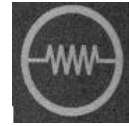

Unit : mm

TYPE	L	RM
PGM200/2WS	18.2	10
PGM400/4WS	23.3	15
PGM500/5WS	33.4	25
PGM650/65S	43.5	35
PGM800/8WS	53.7	45

Unit : mm

TYPE	RM Tolerance	X max.
PGM200/400/500/650/800	+1.0	3.0
PGM2WS/4WS/5WS/65S/8WS	+0.8	1.7

6. Temperature Rise

Solder Joints:

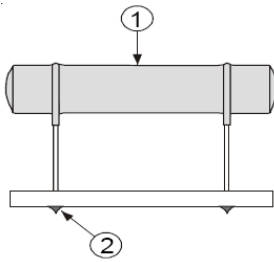

Temperature Rise Curves:

Type PGM200/2WS

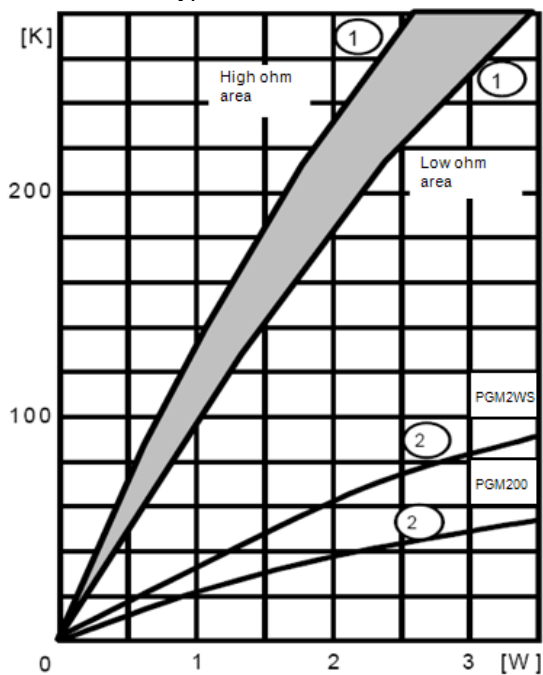

Type PGM400/4WS

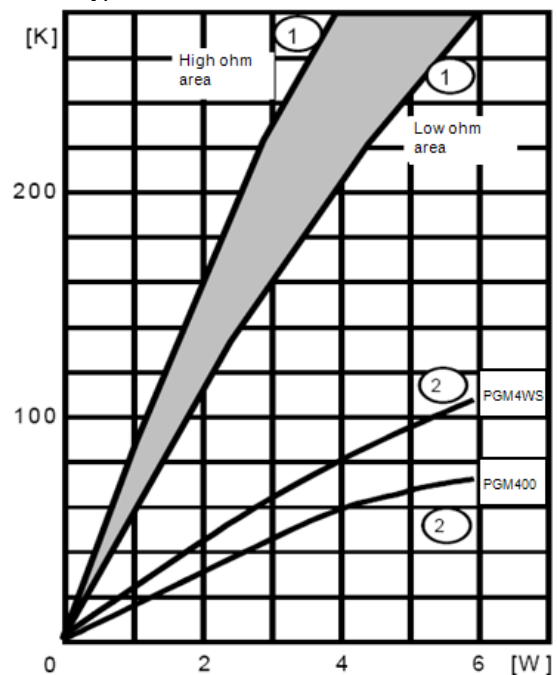

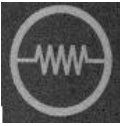

Type PGM500/5WS

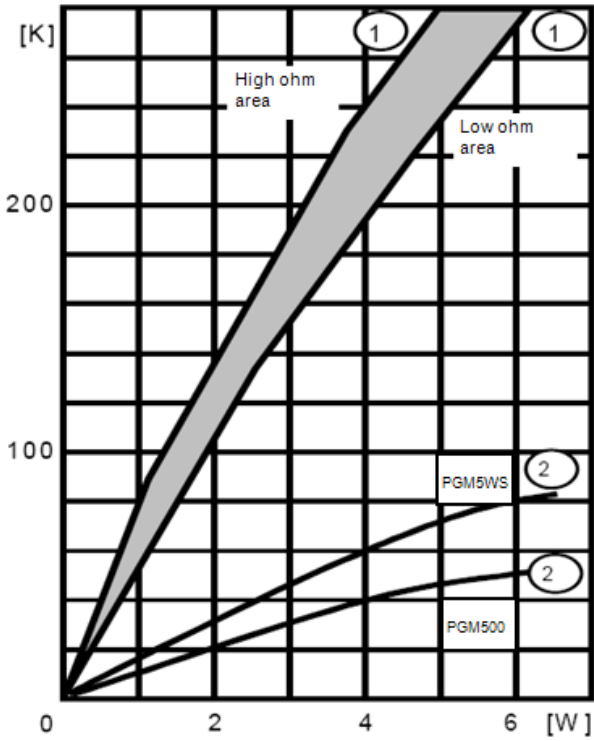

Type PGM650/65S

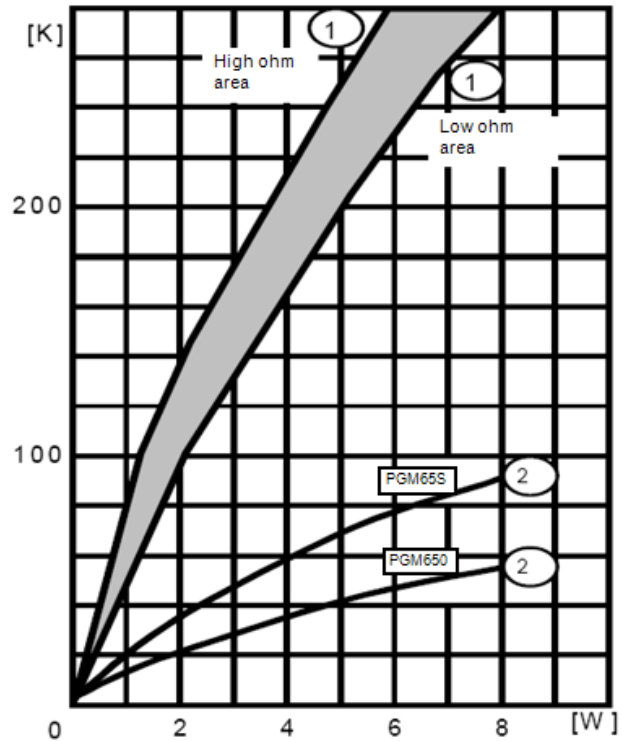

Type PGM800/8WS

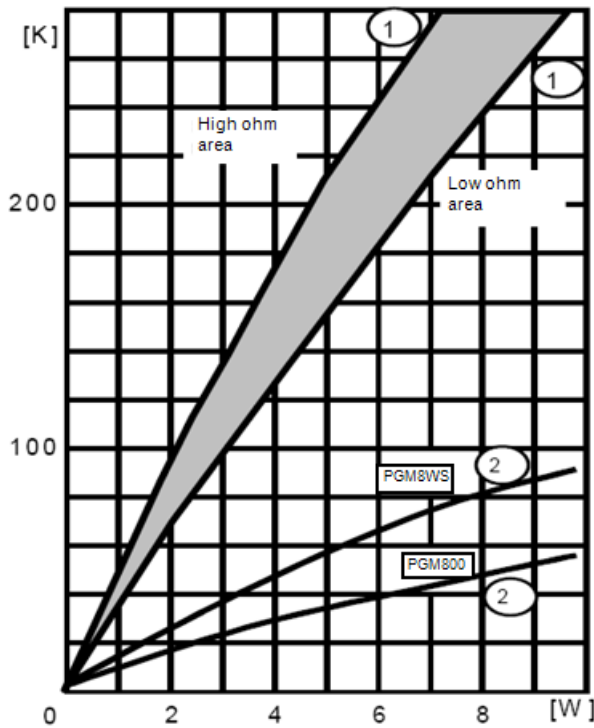

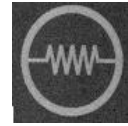

7. ENVIRONMENTAL CHARACTERISTICS

(1) Short Time Over Load Test

At 2.5 times of the rated voltage applied for 5 seconds, the resistor should be free from defects after the resistor is released from load for about 30 minutes

$$\text{Short Time Overload Voltage} = 2.5 * \sqrt{\text{Power Rating} \times \text{Resistance Value}}$$

The change of the resistance value should be within $\pm 2.0\%$

(2) Voltage Proof on Insulation

The resistor shall be clamped in the trough of a 90° metal V Block. Apply the insulation voltage of 75V between the terminals connected together with the block for about 60 seconds.

The resistor shall be able to withstand without breakdown or flashover.

(3) Temperature Coefficient Test

Test of resistors above room temperature $100^{\circ}\text{C} \pm 2^{\circ}\text{C}$ (Testing Temperature 115°C to 130°C) at the constant temperature silicon plate for over 5 minutes. Then measure the resistance value.

The Temperature Coefficient is calculated by the following equation and its value should be within the range of requested.

$$\text{Resistor Temperature Coefficient} = \frac{R - R_0}{R_0} \times \frac{1}{t - t_0} \times 10^6$$

R = Resistance value under the testing temperature

R₀ = Resistance value at the room temperature

t = The testing temperature

t₀ = Room temperature

(4) Solderability

Immerse the specimen into the solder pot at $235 \pm 5^{\circ}\text{C}$ for 3 ± 0.5 seconds.

At least 90% solder coverage on the termination.

(5) Solvent Resistance of Marking

The specimen into the appropriate solvent of IPA condition of ultrasonic machine for 5 ± 0.5 minutes.

The specimen is no deterioration of coatings and color code.

(6) Robustness of Terminations

Direct Load – Resistors shall be held by one terminal and the load shall be gradually applied in the direction of the longitudinal axis of the resistor unit the applied load reached the requirement.

The load shall be held for 10 seconds. The load of weight shall be 4 kg (40N).

(7) Damp Heat Steady State

Place the specimen in a test chamber at 40°C and 93 % relative humidity. Apply the rated voltage to the specimen at the 1.5 hours on and 0.5 hour off cycle. The total length of test is 56 days

The change of the resistance value shall be within $\pm 2\%$

(8) Endurance at 70°C

Placed in the constant temperature chamber of $70 \pm 3^{\circ}\text{C}$ the resistor shall be connected to the lead wire at the point of 25mm. Length with each terminal, the resistors shall be arranged not much effected

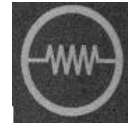

mutually by the temperature of the resistors and the excessive ventilation shall not be performed, for 90 minutes on and 30 minutes off under this condition the rated D.C. voltage is applied continuously for 1000+48/-0 hours then left at no-load for 1 hour, measured at this time the resistance value °

The change of the resistance value shall be within $\pm 3.0\%$.

There shall be no remarkable change in the appearance and the color code shall be legible after the test.

(9) Temperature Cycling Test

The temperature cycle shown in the following table shall be repeated 5 times consecutively. The measurement of the resistance value is done before the first cycle and after ending the fifth cycle, leaving in the room temperature for about 1 hour °

Temperature Cycling Conditions:

Step	Temperature(°C)	Time (minute)
1	-55 \pm 3	30
2	25 \pm 3	10 ~ 15
3	155 \pm 3	30
4	25 \pm 3	10 ~ 15

The change of the resistance value shall be within $\pm 2\%$

After the test the resistor shall be free from the electrical or mechanical damage.

(10) Resistance to Soldering Heat

The terminal lead shall be dipped into the solder pot at 260 \pm 3 °C for 10 \pm 1.0 seconds up to 2.5 ~ 3.5 mm.

The change of the resistance value shall be within $\pm 0.2\%$

8. PACKAGING

Type	Packaging	Pieces	Pack.-Code
PGM200/2WS	Bulk	500	B
		1000	R
PGM400/4WS	Bulk	500	B
		1000	
PGM500/5WS	Bulk	250	B
		500	
PGM650/65S	Bulk	250	B
		500	
PGM800/8WS	Bulk	250	B
		250	

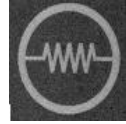

9. Plant Address

- A. China Dongguan Plant
7-1, Gaoli Road, Gaoli Industrial Zone
Tangxia Zhen, Dongguan, Guangdong, China
(廣東省東莞市塘廈鎮高麗工業區高麗路 7-1 號)
Tel. 86-769-8772 0275
Fax. 86-769-8772 0275 #4333

- B. China Suzhou Plant
No.158, Jinchang Road, No.1 Building of Nan Bang IND. Zone,
Mu Du New District, Suzhou, China
(江蘇省蘇州市木瀆新區金長路 158 號南濱工業區 1 號)
Tel. 86-512-66518889
Fax. 86-512-66519889