

## General Description

The AOZ1320 is a P-channel high-side load switch with controlled slew rate. Three slew rate options are available. The AOZ1320-01 and AOZ1320-04 have a slew rate of 1ms, and the AOZ1320-07 has a slew rate of 4.5ms. The AOZ1320-02 and AOZ1320-05 feature fast Slew Rate (less than 500ns). The slew rate of AOZ1320-03 and AOZ1320-06 is 100 $\mu$ s. The AOZ1320-03, AOZ1320-04, AOZ1320-05, and AOZ1320-07 provide an output discharge circuit to quickly discharge the output when the switch is disabled.

The P-channel MOSFET has typical on resistance of 75m $\Omega$ . The very low  $R_{DS(ON)}$  significantly reduces the power path dissipation. The input voltage range of AOZ1320 is from 1.8V to 5.5V. The control input is compatible with both TTL and CMOS logic. Ultra low quiescent current makes this product suitable for any portable applications.

The AOZ1320 is available in a 6-pin SOT23 or 8-pin 2mm X 2mm DFN package and is rated over the -40 $^{\circ}$ C to +85 $^{\circ}$ C ambient temperature range.

## Features

- 1.8V to 5.5V Input Voltage Range
- Input Under-Voltage Lockout
- Low  $R_{DS(ON)}$  (75m $\Omega$  Typical at 5V)
- Controlled Turn-On Slew Rate
  - 1ms (AOZ1320-01, -04)
  - 0.5 $\mu$ s (AOZ1320-02, -05)
  - 100 $\mu$ s (AOZ1320-03, -06)
  - 4.5ms (AOZ1320-07)
- Output Discharge Function (-03, -04, -05)
- Low Quiescent Current (1.2 $\mu$ A typical)
- Low Shutdown Current (<1 $\mu$ A)
- 4.5kV ESD Rating
- Tiny SOT23 or 2mm x 2mm DFN Package

## Applications

- Cellular Phones
- MP3 Players
- Personal Media Players
- Notebook Computers
- Digital Still Cameras
- Hot-Swap Applications



## Typical Application

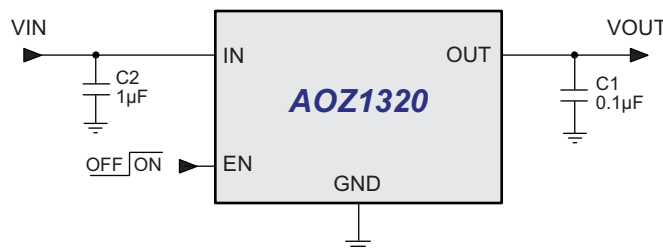

## Ordering Information

Part Number	Slew Rate	Output Discharge	Package	Environmental
AOZ1320CI-01*	1ms	No	SOT23-6	RoHS Compliant
AOZ1320CI-02	0.5µs	No	SOT23-6	RoHS Compliant
AOZ1320CI-03*	100µs	Yes	SOT23-6	RoHS Compliant
AOZ1320CI-04	1ms	Yes	SOT23-6	RoHS Compliant
AOZ1320CI-05	0.5µs	Yes	SOT23-6	RoHS Compliant
AOZ1320CI-06*	100µs	No	SOT23-6	RoHS Compliant
AOZ1320CI-07	4.5ms	Yes	SOT23-6	RoHS Compliant
AOZ1320DI-01	1ms	No	2x2 DFN-8	RoHS Compliant
AOZ1320DI-02	0.5µs	No	2x2 DFN-8	RoHS Compliant
AOZ1320DI-03	100µs	Yes	2x2 DFN-8	RoHS Compliant
AOZ1320DI-04	1ms	Yes	2x2 DFN-8	RoHS Compliant
AOZ1320DI-05	0.5µs	Yes	2x2 DFN-8	RoHS Compliant
AOZ1320DI-06	100µs	No	2x2 DFN-8	RoHS Compliant

\* Contact manufacturer for availability.



All AOS products are offered in packages with Pb-free plating and compliant to RoHS standards. Green Products use reduced levels of Halogens, and are also RoHS compliant. Please visit [www.aosmd.com/media/AOSGreenPolicy.pdf](http://www.aosmd.com/media/AOSGreenPolicy.pdf) for additional information.

## Pin Configuration

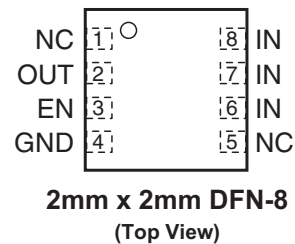
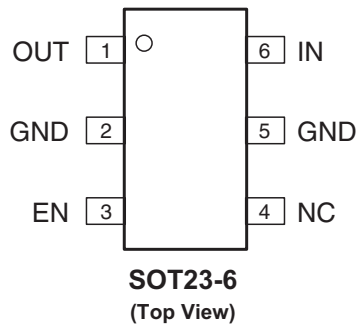

## Pin Description

Pin Name	Pin Number		Pin Function
	DFN-8	SOT23-6	
IN	6, 7, 8	6	Input. IN is the drain of the P-channel MOSFET. It is the supply input of the IC.
GND	4	2, 5	Ground.
OUT	2	1	Output. OUT is the source of the P-channel MOSFET.
EN	3	3	Enable. The P-channel MOSFET turns on when EN is logic HIGH.
NC	1, 5	4	No Connect. This pin is not internally connected.

### Absolute Maximum Ratings

Exceeding the Absolute Maximum ratings may damage the device.

Parameter	Rating
IN to GND	-0.3V to 6V
EN to GND	-0.3V to 6V
OUT to GND	-0.3V to $V_{IN} + 0.3V$
Maximum Continuous Switch Current	
SOT23-6	1.6A
2x2 DFN-8	2.3A
Maximum Pulsed Current ( $V_{IN} > 2.5V$ )	6A
Maximum Pulsed Current ( $V_{IN} < 2.5V$ )	3A
Storage Temperature ( $T_S$ )	-65°C to +150°C
ESD Rating <sup>(1)</sup>	4.5kV

**Note:**

1. Devices are inherently ESD sensitive, handling precautions are required. Human body model is a 100pF capacitor discharging through a 1.5k $\Omega$  resistor.

### Recommend Operating Ratings

The device is not guaranteed to operate beyond the Maximum Operating Ratings.

Parameter	Rating
Operating Junction Temperature ( $T_J$ )	-40°C to +150°C
Power Dissipation	
SOT23-6	0.65W
2x2 DFN-8	1.54W
Package Thermal Resistance	
SOT23-6 ( $\Theta_{JA}$ )	191°C/W
2x2 DFN-8 ( $\Theta_{JA}$ )	81°C/W

## Electrical Characteristics

$T_A = 25^\circ\text{C}$ ,  $V_{IN} = V_{EN} = 5\text{V}$ , unless otherwise specified. Specifications in **BOLD** indicate an ambient temperature range of  $-40^\circ\text{C}$  to  $+85^\circ\text{C}$ .

Symbol	Parameter	Conditions	Min.	Typ.	Max.	Units
$V_{IN}$	Operating Voltage Range		<b>1.8</b>	<b>5</b>	<b>5.5</b>	V
$V_{UVLO}$	Under-Voltage Lockout Threshold	$V_{IN}$ Falling $V_{IN}$ Rising	<b>0.7</b> <b>1.0</b>	<b>0.9</b> <b>1.2</b>	<b>1.3</b> <b>1.6</b>	V
$I_{IN}$	Input Quiescent Current	$V_{EN} = 5.0\text{V}$ $V_{EN} = \text{GND}$		<b>1.2</b>	<b>4</b> <b>1</b>	$\mu\text{A}$
$I_{OUT(OFF)}$	Switch Leakage Current	$V_{EN} < V_{IL(max)}$ , $V_{OUT} = 0\text{V}$			<b>1</b>	$\mu\text{A}$
$R_{DS(ON)}$	Switch On-Resistance	$V_{IN} = 5.0\text{V}$ $V_{IN} = 4.2\text{V}$ $V_{IN} = 3.0\text{V}$ $V_{IN} = 1.8\text{V}$		75 78 81 109	100 105 110 150	m $\Omega$
$V_{IL}$	Enable Input-Low Voltage				<b>0.8</b>	V
$V_{IH}$	Enable Input-High Voltage	$V_{IN} = 1.8\text{V}$ to $2.0\text{V}$ $V_{IN} = 2.0\text{V}$ to $4.2\text{V}$ $V_{IN} = 4.2\text{V}$ to $5.5\text{V}$	<b>1.8</b> <b>2.0</b> <b>2.4</b>			V
$I_{EN}$	Enable Input Leakage Current	$V_{EN} = 5.5\text{V}$			<b>1</b>	$\mu\text{A}$
<b>AOZ1320-01, -04</b>						
$T_{D(ON)}$	Output Turn-on delay	$R_L = 10\Omega$ , See Figure 1		200	300	$\mu\text{s}$
$T_R$	Output Rise-time	$R_L = 10\Omega$ , See Figure 1		1000	1500	$\mu\text{s}$
$T_{D(OFF)}$	Output Turn-off delay	$R_L = 10\Omega$ , See Figure 1		20	30	$\mu\text{s}$
<b>AOZ1320-02, -05</b>						
$T_{D(ON)}$	Output Turn-On Delay	$R_L = 10\Omega$ , See Figure 1		2	4	$\mu\text{s}$
$T_R$	Output Rise-Time	$R_L = 10\Omega$ , See Figure 1		0.5	1	$\mu\text{s}$
$T_{D(OFF)}$	Output Turn-Off Delay	$R_L = 10\Omega$ , See Figure 1		20	30	$\mu\text{s}$
<b>AOZ1320-03, -06</b>						
$T_{D(ON)}$	Output Turn-On Delay	$R_L = 10\Omega$ , See Figure 1		20	130	$\mu\text{s}$
$T_R$	Output Rise Time	$R_L = 10\Omega$ , See Figure 1		100	150	$\mu\text{s}$
$T_{D(OFF)}$	Output Turn-Off Delay	$R_L = 10\Omega$ , See Figure 1		20	30	$\mu\text{s}$
<b>AOZ1320-07</b>						
$T_{D(ON)}$	Output Turn-On Delay	$R_L = 10\Omega$ , See Figure 1		450	850	$\mu\text{s}$
$T_R$	Output Rise Time	$R_L = 10\Omega$ , See Figure 1		4500	7500	$\mu\text{s}$
$T_{D(OFF)}$	Output Turn-Off Delay	$R_L = 10\Omega$ , See Figure 1		20	30	$\mu\text{s}$
<b>AOZ1320-03, -04, -05, -07</b>						
$R_{DIS}$	Output Pull-Down Resistance in Shutdown	$V_{EN} < V_{IL(max)}$		180	250	$\Omega$

## Typical Performance Characteristics

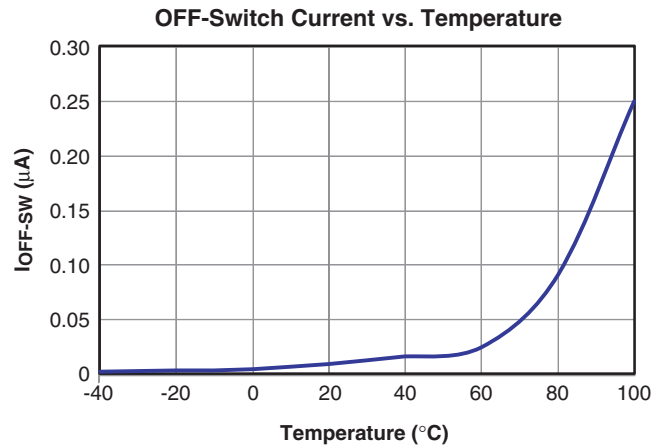
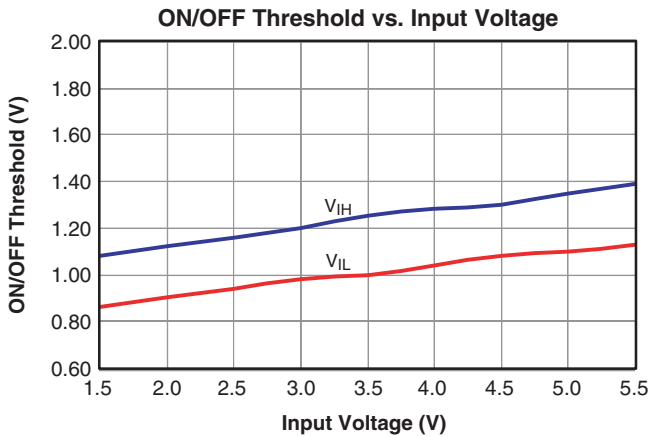
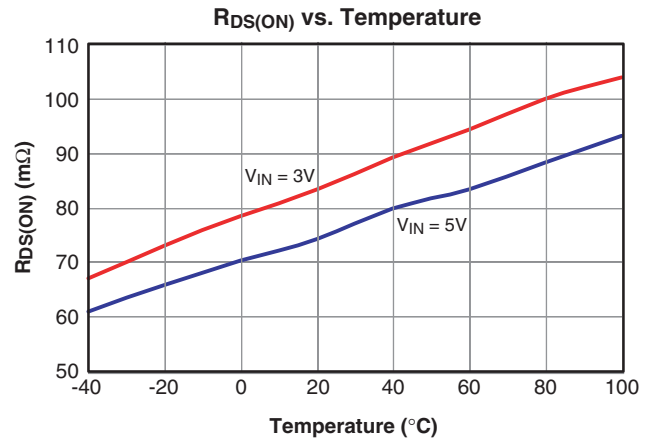
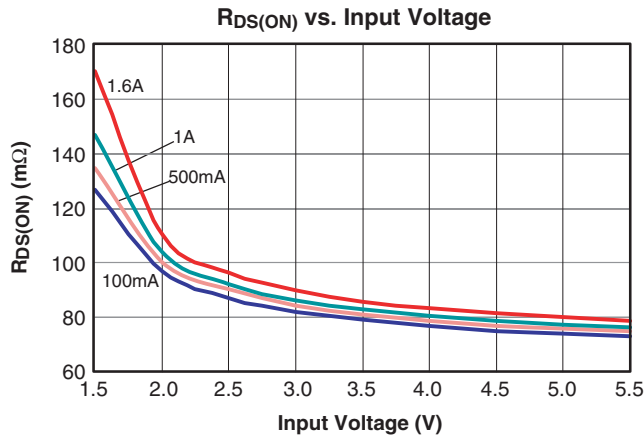
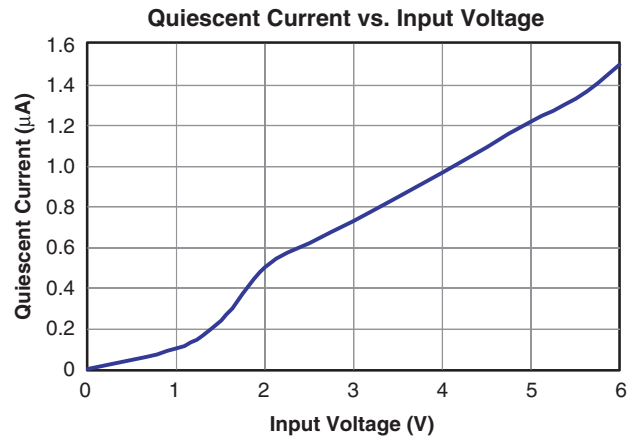
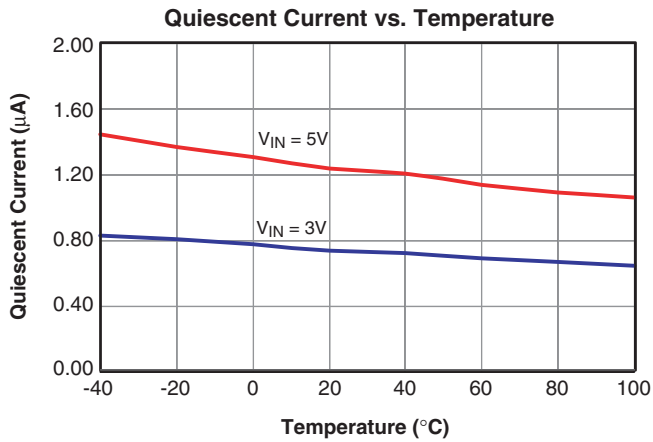

## Typical Characteristics

AOZ1320-01, AOZ1320-04

**Turn-On**  
( $V_{IN} = 3V, R = 6\Omega$ )

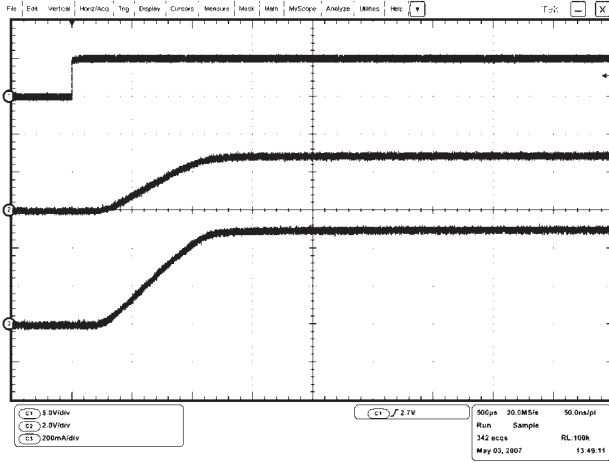

CH1: On/Off (5V/div)  
CH2:  $V_{OUT}$  (2V/div)  
CH3:  $I_{IN}$  (200mA/div)  
Time: 500µS/div

**Turn-On**  
( $V_{IN} = 5V, R = 10\Omega$ )

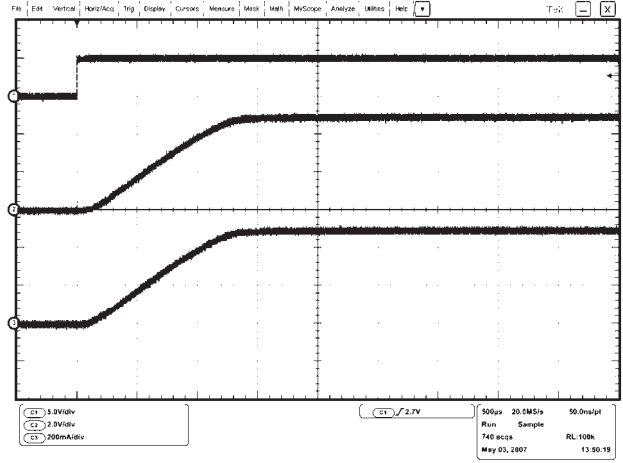

CH1: On/Off (5V/div)  
CH2:  $V_{OUT}$  (2V/div)  
CH3:  $I_{IN}$  (200mA/div)  
Time: 500µS/div

**Turn-Off**  
( $V_{IN} = 3V, R = 6\Omega$ )

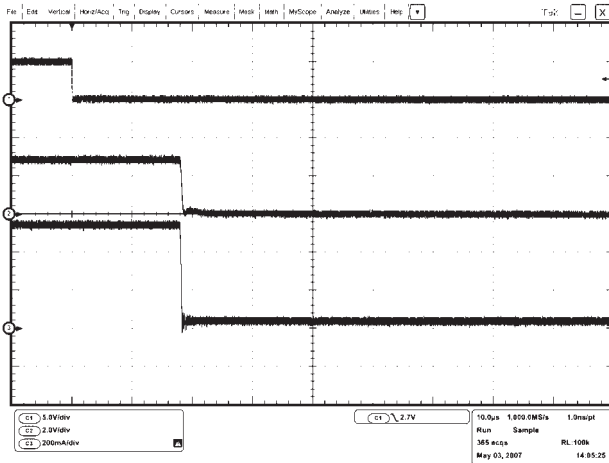

CH1: On/Off (5V/div)  
CH2:  $V_{OUT}$  (2V/div)  
CH3:  $I_{IN}$  (200mA/div)  
Time: 10µS/div

**Turn-Off**  
( $V_{IN} = 5V, R = 10\Omega$ )

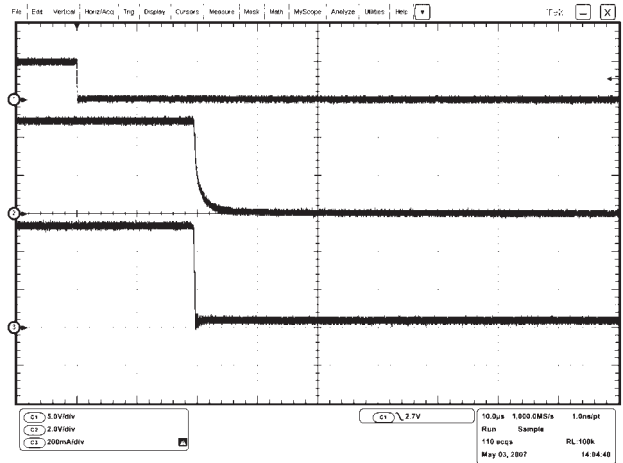

CH1: On/Off (5V/div)  
CH2:  $V_{OUT}$  (2V/div)  
CH3:  $I_{IN}$  (200mA/div)  
Time: 10µS/div

Typical Characteristics (Continued)

AOZ1320-02, AOZ1320-05

Turn-On  
( $V_{IN} = 3V, R = 6\Omega$ )

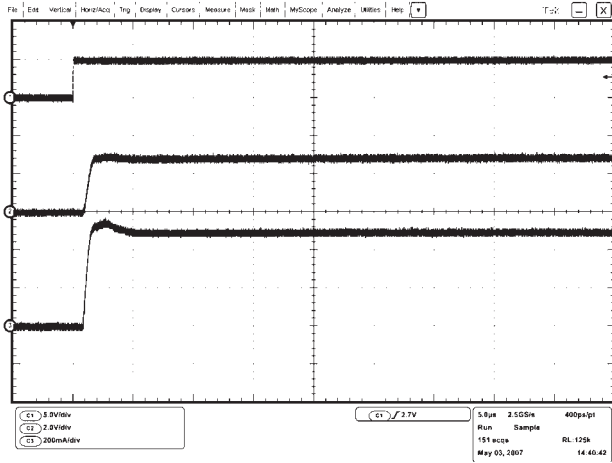

CH1: On/Off (5V/div)  
CH2:  $V_{OUT}$  (2V/div)  
CH3:  $I_{IN}$  (200mA/div)  
Time: 5μS/div

Turn-On  
( $V_{IN} = 5V, R = 10\Omega$ )

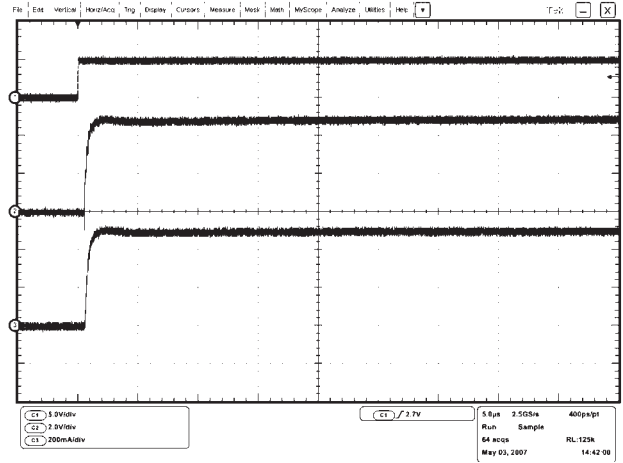

CH1: On/Off (5V/div)  
CH2:  $V_{OUT}$  (2V/div)  
CH3:  $I_{IN}$  (200mA/div)  
Time: 5μS/div

Turn-Off  
( $V_{IN} = 3V, R = 6\Omega$ )

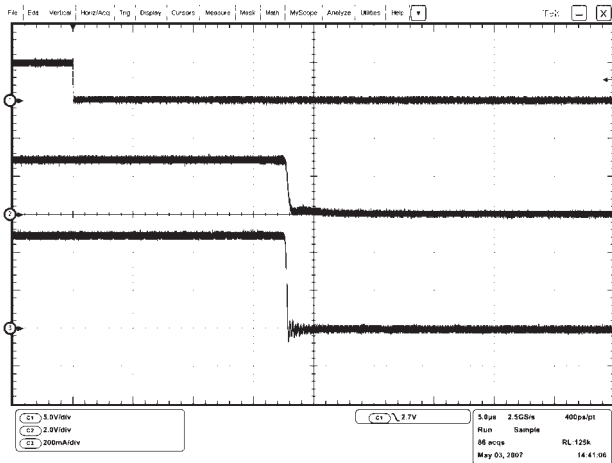

CH1: On/Off (5V/div)  
CH2:  $V_{OUT}$  (2V/div)  
CH3:  $I_{IN}$  (200mA/div)  
Time: 5μS/div

Turn-Off  
( $V_{IN} = 5V, R = 10\Omega$ )

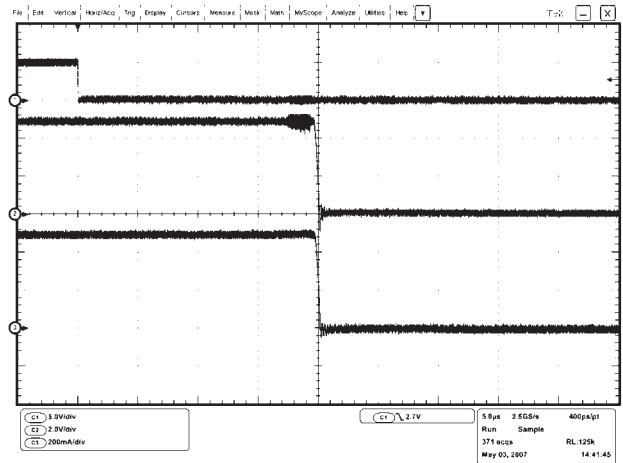

CH1: On/Off (5V/div)  
CH2:  $V_{OUT}$  (2V/div)  
CH3:  $I_{IN}$  (200mA/div)  
Time: 5μS/div

Typical Characteristics (Continued)

AOZ1320-03, AOZ1320-06

Turn-On  
( $V_{IN} = 3V, R = 6\Omega$ )

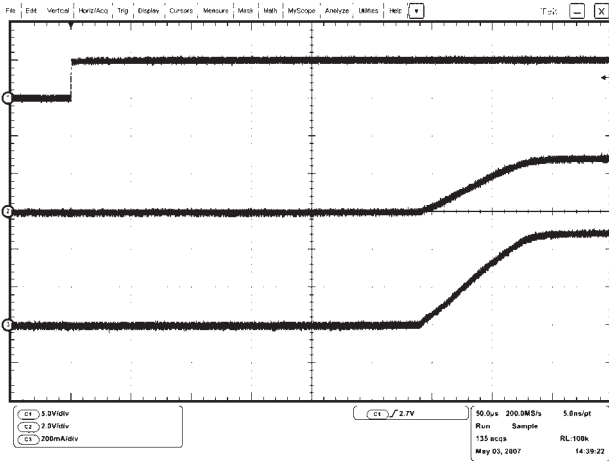

CH1: On/Off (5V/div)  
CH2:  $V_{OUT}$  (2V/div)  
CH3:  $I_{IN}$  (200mA/div)  
Time: 50µS/div

Turn-On  
( $V_{IN} = 5V, R = 10\Omega$ )

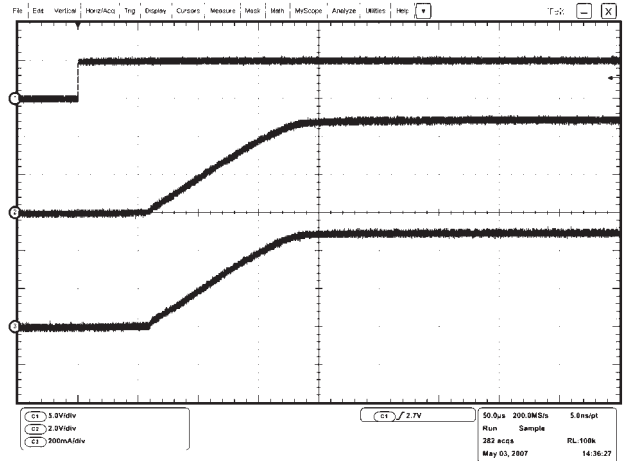

CH1: On/Off (5V/div)  
CH2:  $V_{OUT}$  (2V/div)  
CH3:  $I_{IN}$  (200mA/div)  
Time: 50µS/div

Turn-Off  
( $V_{IN} = 3V, R = 6\Omega$ )

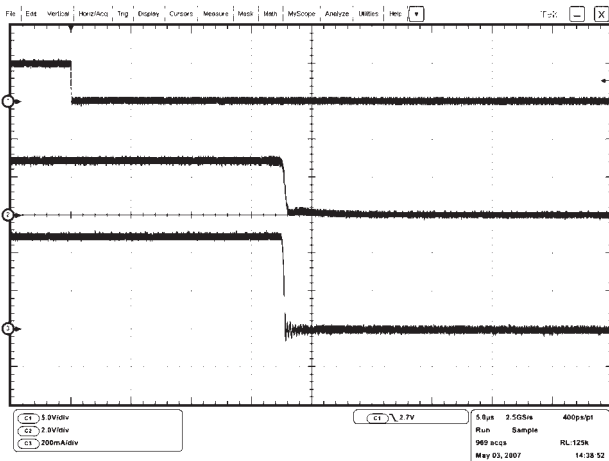

CH1: On/Off (5V/div)  
CH2:  $V_{OUT}$  (2V/div)  
CH3:  $I_{IN}$  (200mA/div)  
Time: 5µS/div

Turn-Off  
( $V_{IN} = 5V, R = 10\Omega$ )

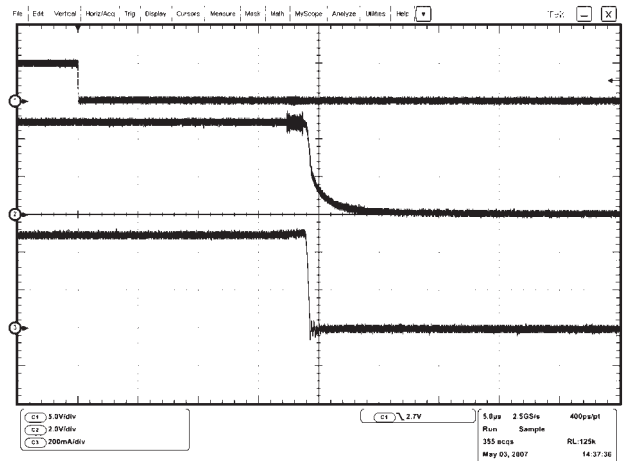

CH1: On/Off (5V/div)  
CH2:  $V_{OUT}$  (2V/div)  
CH3:  $I_{IN}$  (200mA/div)  
Time: 5µS/div



Typical Characteristics (Continued)

AOZ1320-07

Turn-On  
( $V_{IN} = 3V, R = 6\Omega$ )

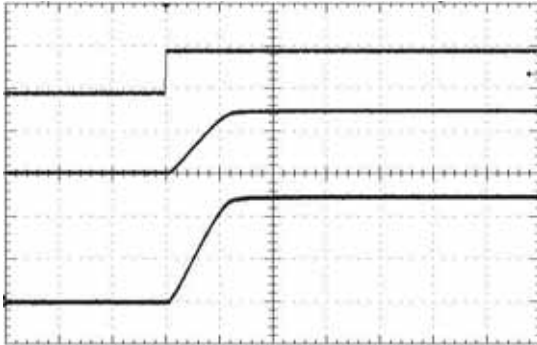

CH1: On/Off (5V/div) CH2:  $V_{OUT}$  (2V/div)  
CH3:  $I_{IN}$  (200mA/div) Time: 4mS/div

Turn-On  
( $V_{IN} = 5V, R = 10\Omega$ )

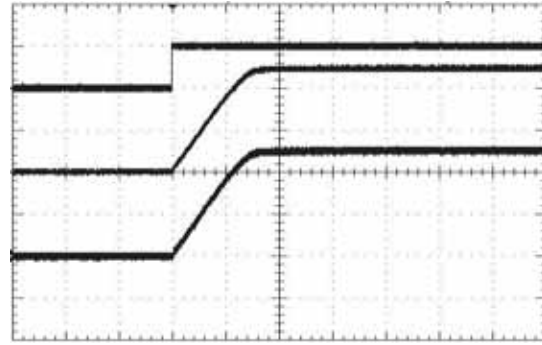

CH1: On/Off (5V/div) CH2:  $V_{OUT}$  (2V/div)  
CH3:  $I_{IN}$  (200mA/div) Time: 4mS/div

Turn-Off  
( $V_{IN} = 3V, R = 6\Omega$ )

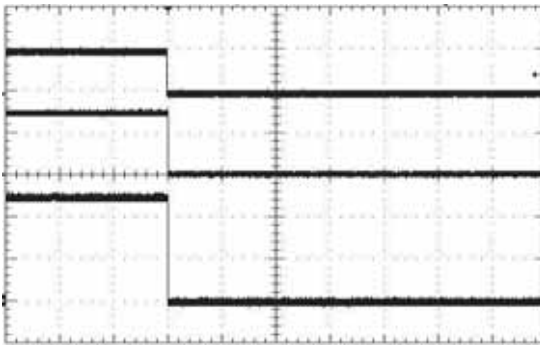

CH1: On/Off (5V/div) CH2:  $V_{OUT}$  (2V/div)  
CH3:  $I_{IN}$  (200mA/div) Time: 4ms/div

Turn-Off  
( $V_{IN} = 5V, R = 10\Omega$ )

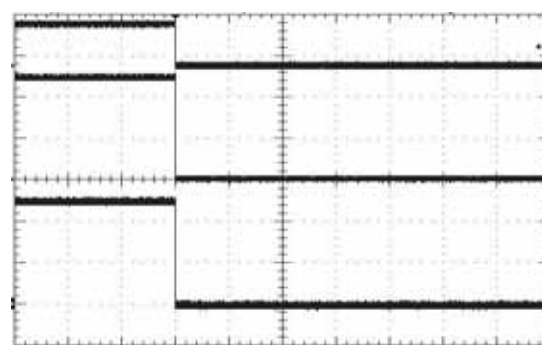

CH1: On/Off (5V/div) CH2:  $V_{OUT}$  (2V/div)  
CH3:  $I_{IN}$  (200mA/div) Time: 4mS/div

AOZ1320-03, AOZ1320-04, AOZ1320-05, AOZ1320-07

Turn-Off  
Output Discharge  
( $V_{IN} = V_{EN} = 5V, V_{OUT} = 5V, C_{OUT} = 4.7\mu F, T_A = 25^\circ C$ )

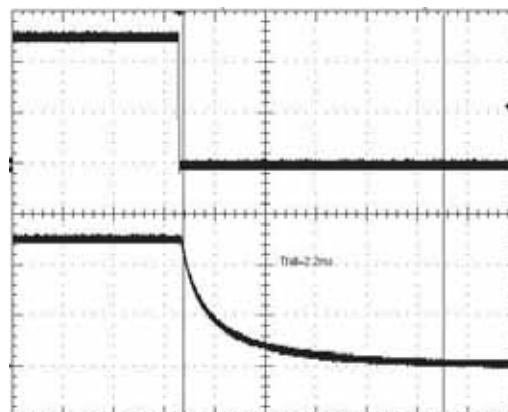

CH1:  $V_{EN}$  (2V/div) CH2:  $V_{OUT}$  (2V/div)  
Time: 400μs/div

### Timing Diagram

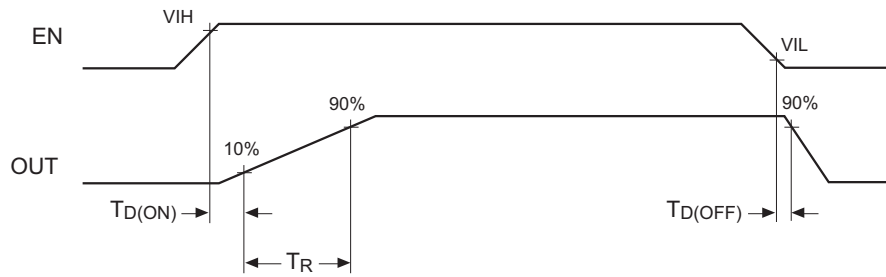

Figure 1. AOZ1320 Timing Diagram

### Functional Block Diagram

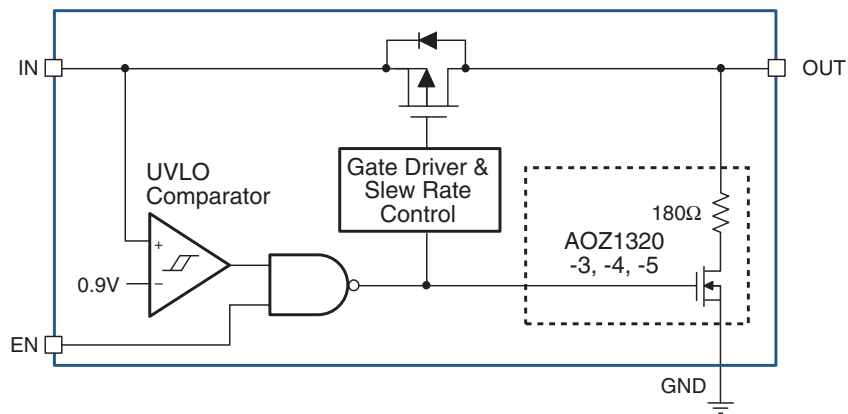

Figure 2. Functional Block Diagram

## Detailed Description

### Slew Rate Control

The AOZ1320 is a family of P-channel high-side load switches with controlled slew rate. The device is enabled when the input voltage is above the Under-Voltage Lockout (UVLO) threshold and the EN pin is high. Once enabled, the gate driver and slew-rate control circuitry immediately raises the source-to-gate voltage of the P-channel MOSFET to its threshold level, and then gradually turns on the MOSFET by linearly increases the source-to-gate voltage. This slow turn-on action effectively limits the input inrush current and provides a nice ramp for the output voltage. After the MOSFET is fully enhanced, the AOZ1320 quickly increases the source-to-gate voltage to the full input voltage to minimize on resistance and reduce power dissipation.

Three slew-rate options are available. AOZ1320-01 and -04 have a slew rate of 1ms, and the AOZ1320-07 has a slew rate of 4.5ms. This option significantly reduces the inrush current when the MOSFET turns on, allowing the use of very small input capacitor. AOZ1320-02 and -05 have no slew rate control and the MOSFET can be turned on within 500ns. This option is suitable for applications that require very fast switching. AOZ1320-03 and -06 have a moderate slew rate to 100µs. The AOZ1320-03, -04, -05, and -07 options include an internal output discharge circuit that quickly discharges the output to ground when the device is disabled.

### Input Under-Voltage Lockout

The operating voltage range of AOZ1320 is from 1.8V to 5.5V. An internal UVLO comparator monitors the input voltage. The device is disabled if the input voltage falls below the UVLO threshold (0.9V typical). The UVLO comparator has about 300mV hysteresis.

### On/Off Control

The AOZ1320 is enabled when the input voltage is above the UVLO threshold and the EN pin is asserted high. The device is disabled when the input voltage is below the UVLO threshold or the EN pin is asserted low. The EN input is compatible with both TTL and CMOS logic.

### Internal Discharge Resistor

The AOZ1320 has an internal 180Ω resistor to discharge any remaining voltage from the system to the ground that is store in a capacitive load. This provides a safe shutdown of the system to prevent any damages to the devices. This function is controlled from the Enable pin.

## Applications Information

### Input Capacitor Selection

Use a 1µF or larger capacitor for input bypassing. Place the capacitor close to the IN pins of AOZ1320.

### Output Capacitor Selection

Use a 0.1µF or larger capacitor between OUT and GND. The capacitance does not affect the turn-on slew rate. However, a larger capacitor makes the initial turn-on transient smoother.

### Thermal Considerations

To ensure proper operation, the maximum junction temperature ( $T_{J(MAX)}$ ) of AOZ1320 should not exceed 150°C. Several factors attribute to the junction temperature rise: load current, MOSFET on resistance ( $R_{DS(ON)}$ ), on-resistance temperature coefficient ( $T_C$ ), junction-to-ambient thermal resistance ( $\Theta_{JA}$ ), and ambient temperature ( $T_A$ ). Use the following equation to determine the maximum continuous load current  $I_{LOAD(MAX)}$ :

$$I_{LOAD(MAX)} = \sqrt{\frac{T_{J(MAX)} - T_A}{\Theta_{JA} \cdot R_{DS(ON)} \cdot [1 + T_C \cdot (T_{J(MAX)} - T_A)]}}$$

where  $R_{DS(ON)}$  is the maximum value of the MOSFET on resistance at 25°C. Please note the maximum load current should not exceed the absolute maximum current rating of the switch. For the SOT-23 package, the absolute maximum current rating is 1.6A. For the 2x2 DFN package, the absolute maximum current rating is 2.3A.

For example, when  $V_{IN} = 5V$ , the maximum continuous load current of SOT-23 package at room temperature is:

$$I_{LOAD(MAX)} = \sqrt{\frac{150^{\circ}\text{C} - 25^{\circ}\text{C}}{120^{\circ}\text{C}/\text{W} \cdot 100\text{m}\Omega \cdot [1 + 0.0028 \cdot (150^{\circ}\text{C} - 25^{\circ}\text{C})]}} = 2.78\text{A}$$

Since the calculated current is greater than the absolute maximum current rating, the maximum load current at  $V_{IN} = 5V$  and room temperature is 1.6A.

Exceeding the maximum continuous load current may cause damage to the device. Figure 3 and Figure 4 show the maximum load current as a function of the ambient temperature for SOT23 and 2x2 DFN packages respectively. To ensure proper operation, the load current should not exceed the limits in these two figures.

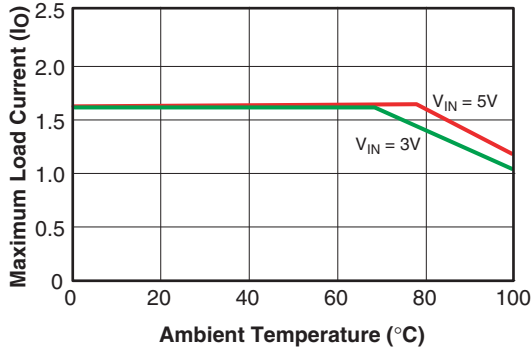

Figure 3. Maximum Load Current Thermal Derating for SOT23 Package

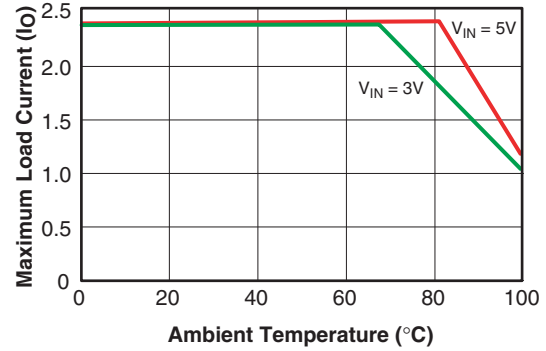

Figure 4. Maximum Load Current Thermal Derating for 2x2 DFN Package

### Layout Guidelines

Good PCB is important for improving the thermal performance of AOZ1320. Place the input and output bypass capacitors close to the IN and OUT pins. The input and output PCB traces should be as wide as possible for the given PCB space. Use a ground plane to enhance the

power dissipation capability of the device. The AOZ1320 evaluation board can be used as a layout example. The PCB layout of AOZ1320 evaluation board is shown in Figure 5 and 6.

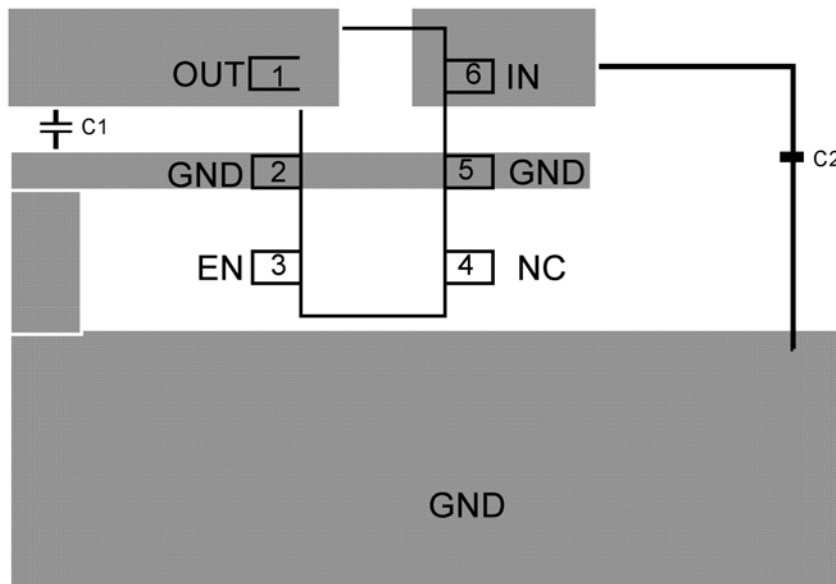

Figure 5. AOZ1320 (SOT23-6) PCB Layout

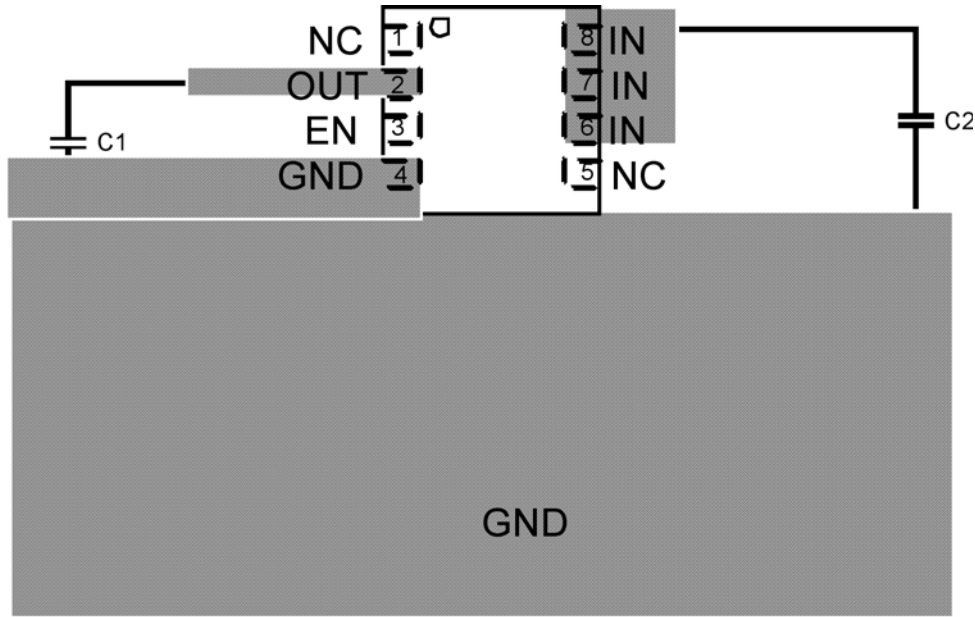
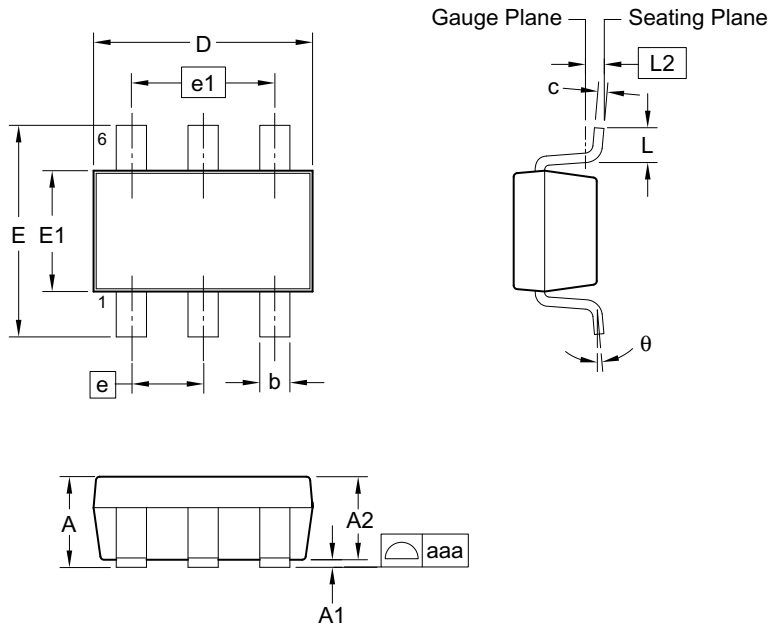
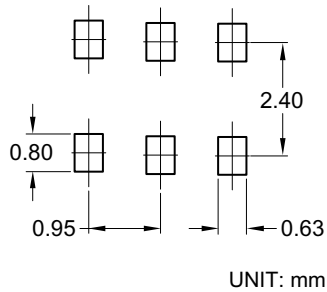

Figure 6. AOZ1320 (DFN2x2) PCB Layout

### Package Dimensions, SOT23-6 LP



#### RECOMMENDED LAND PATTERN



#### Dimensions in millimeters

Symbols	Min.	Nom.	Max.
A	—	—	1.00
A1	0.00	—	0.10
A2	0.70	0.88	0.95
b	0.35	0.40	0.50
c	0.10	0.13	0.20
D	2.80	2.90	3.00
E	2.60	2.80	3.00
E1	1.50	1.60	1.70
e	0.95 BSC		
e1	1.90 BSC		
L	0.30	0.40	0.60
L2	0.25 BSC		
aaa	0.10		
θ	0°	—	8°

#### Dimensions in inches

Symbols	Min.	Nom.	Max.
A	—	—	0.039
A1	0.00	—	0.004
A2	0.028	0.035	0.037
b	0.014	0.016	0.020
c	0.004	0.005	0.008
D	0.110	0.114	0.118
E	0.102	0.110	0.118
E1	0.059	0.063	0.067
e	0.037 BSC		
e1	0.075 BSC		
L	0.012	0.016	0.024
L2	0.010 BSC		
aaa	0.004		
θ	0°	—	8°

#### Notes:

1. Package body sizes exclude mold flash and gate burrs. Mold flash at the non-lead sides should be less than 5 mils each.
2. Dimension "L" is measured in gauge plane.
3. Tolerance  $\pm 0.100\text{mm}$  (4 mil) unless otherwise specified.
4. Refer to JEDEC MO-193C AB.
6. Controlling dimension is millimeter. Converted inch dimensions are not necessarily exact.

### Tape and Reel Dimensions, SOT23-6

#### Tape

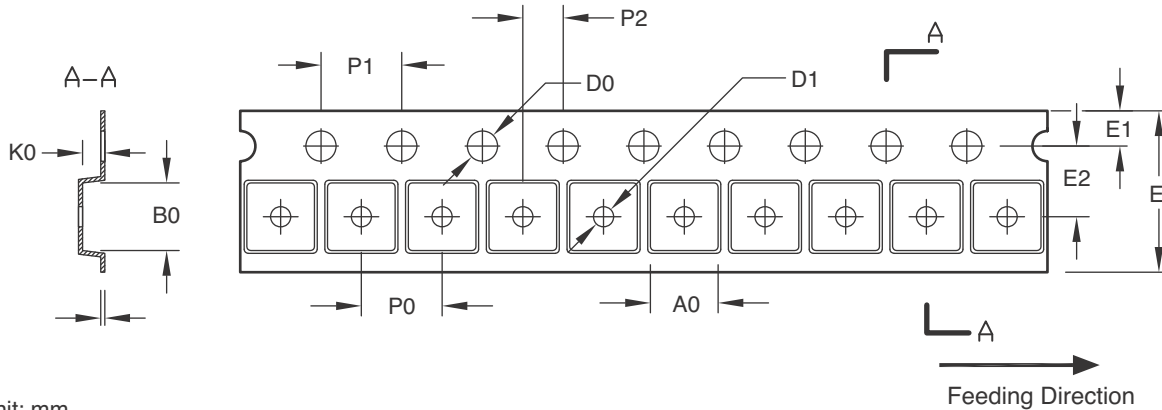

Unit: mm

Package	A0	B0	K0	D0	D1	E	E1	E2	P0	P1	P2	T
SOT23-5/6L LP	3.15 ±0.10	3.20 ±0.10	1.40 ±0.10	1.50 ±0.05	1.00 +0.10 / -0	8.00 ±0.30	1.75 ±0.10	3.50 ±0.05	4.00 ±0.10	4.00 ±0.10	2.00 ±0.05	0.23 ±0.03

#### Reel

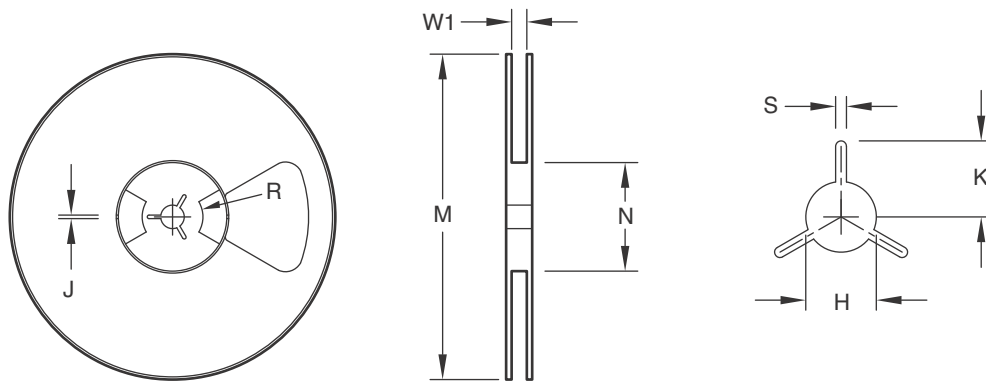

Unit: mm

Tape Size	Reel Size	M	N	W1	H	S	K	R	J
8mm	∅177.8	∅177.8 Max.	55.0 Min.	8.4 +1.50 / -0.0	13.0 +0.5 / -0.2	1.5 Min	10.1 Min.	12.7	4.0 ±0.1

#### Leader/Trailer and Orientation

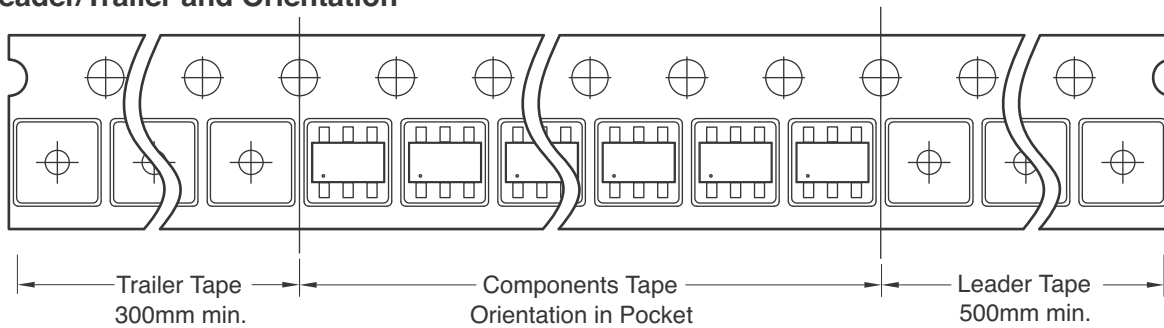

Package Dimensions, DFN 2x2 8L

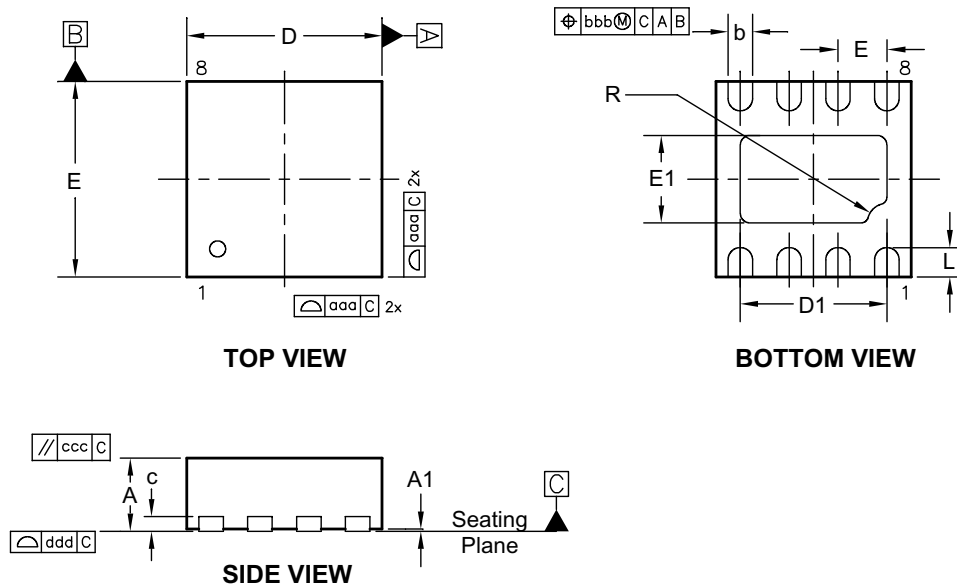

RECOMMENDED LAND PATTERN

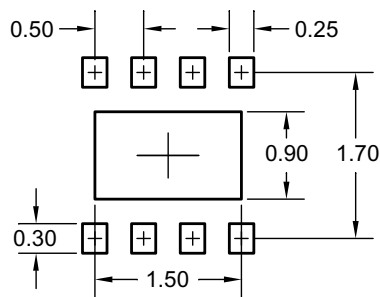

UNIT: mm

Dimensions in millimeters

Symbols	Min.	Nom.	Max.
A	0.70	0.75	0.80
A1	0.00	0.02	0.05
b	0.18	0.25	0.30
c	0.15	0.20	0.25
D	2.00 BSC		
D1	1.35	1.50	1.60
E	2.00 BSC		
E1	0.75	0.90	1.00
e	0.50 BSC		
L	0.20	0.30	0.40
R	0.20		
aaa	0.15		
bbb	0.10		
ccc	0.10		
ddd	0.08		

Dimensions in inches

Symbols	Min.	Nom.	Max.
A	0.028	0.030	0.031
A1	0.000	0.001	0.002
b	0.007	0.010	0.012
c	0.006	0.008	0.010
D	0.079 BSC		
D1	0.053	0.059	0.063
E	0.079 BSC		
E1	0.030	0.035	0.039
e	0.020 BSC		
L	0.008	0.012	0.016
R	0.008		
aaa	0.006		
bbb	0.004		
ccc	0.004		
ddd	0.003		

Notes:

1. Dimensions and tolerances conform to ASME Y14.5M-1994.
2. Controlling dimension is millimeter, converted inch dimensions are not necessarily exact.
3. Dimension b applied to metallized terminal and is measured between 0.10mm and 0.30mm from the terminal tip. If the terminal has the optional radius on the other end of the terminal, dimension b should not be measured in that radius area.
4. Coplanarity ddd applies to the terminals and all other bottom surface metallization.



## Tape and Reel Dimensions, DFN 2 x 2

### Carrier Tape

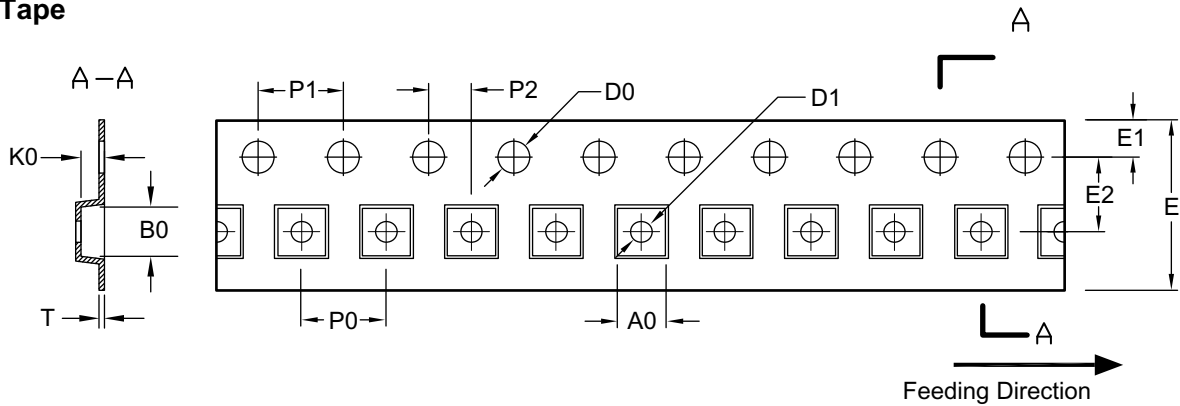

UNIT: mm

Package	A0	B0	K0	D0	D1	E	E1	E2	P0	P1	P2	T
DFN 2x2	2.25 ±0.05	2.25 ±0.05	1.00 ±0.05	1.50 +0.10/-0	1.00 +0.25/-0	8.00 +0.30/-0.10	1.75 ±0.10	3.50 ±0.05	4.00 ±0.10	4.00 ±0.10	2.00 ±0.10	0.254 ±0.02

### Reel

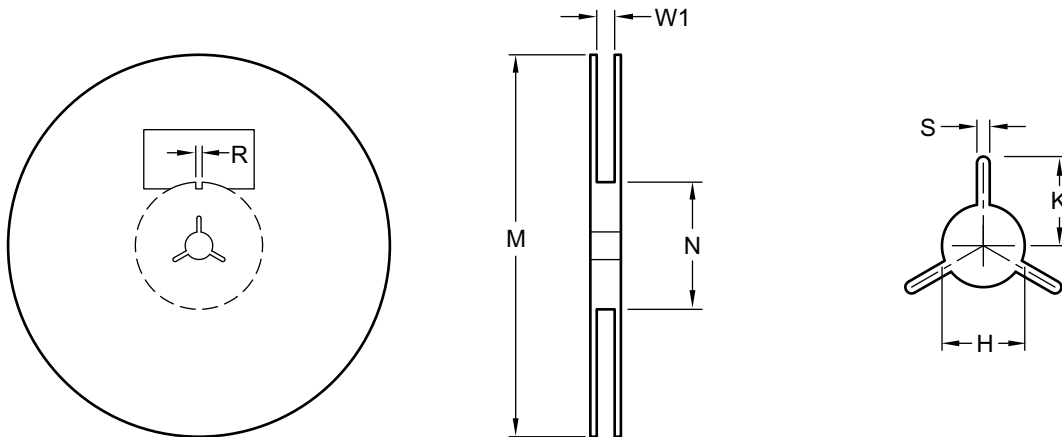

UNIT: mm

Tape Size	Reel Size	M	N	W1	H	S	K	R
8mm	ø180	ø180.00 ±0.50	60.0 ±0.50	8.4 +1.5/-0.0	13.0 ±0.20	1.5 Min.	13.5 Min.	3.0 ±0.50

### Leader/Trailer & Orientation

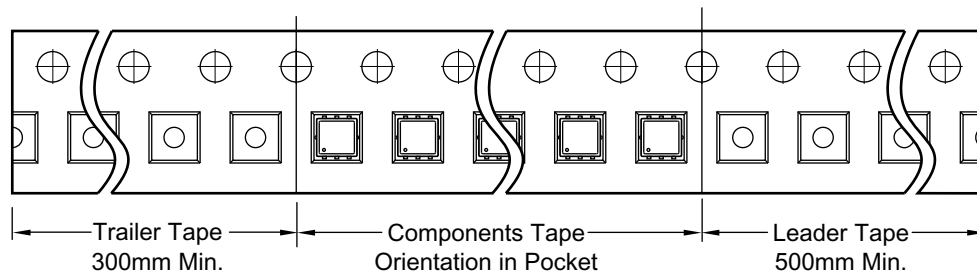

## Package Marking

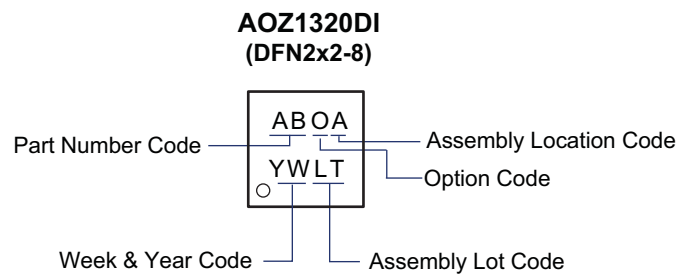
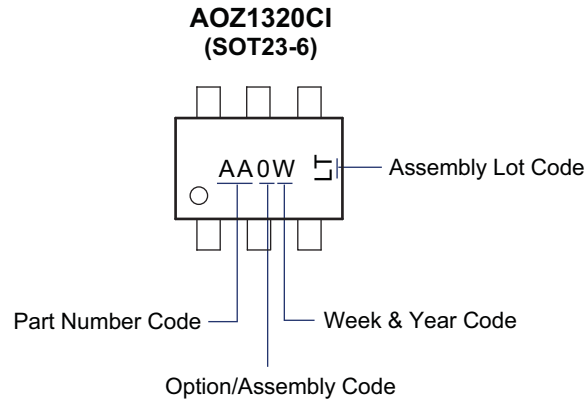

### LEGAL DISCLAIMER

Alpha and Omega Semiconductor makes no representations or warranties with respect to the accuracy or completeness of the information provided herein and takes no liabilities for the consequences of use of such information or any product described herein. Alpha and Omega Semiconductor reserves the right to make changes to such information at any time without further notice. This document does not constitute the grant of any intellectual property rights or representation of non-infringement of any third party's intellectual property rights.

### LIFE SUPPORT POLICY

ALPHA AND OMEGA SEMICONDUCTOR PRODUCTS ARE NOT AUTHORIZED FOR USE AS CRITICAL COMPONENTS IN LIFE SUPPORT DEVICES OR SYSTEMS.

As used herein:

1. Life support devices or systems are devices or systems which, (a) are intended for surgical implant into the body or (b) support or sustain life, and (c) whose failure to perform when properly used in accordance with instructions for use provided in the labeling, can be reasonably expected to result in a significant injury of the user.
2. A critical component in any component of a life support, device, or system whose failure to perform can be reasonably expected to cause the failure of the life support device or system, or to affect its safety or effectiveness.