

Archer Connectors

The Archer range from Harwin is a series of 1.27mm (0.05") pitch connectors, offering single and double row options at half the PCB footprint of a 2.54mm (0.1") pitch connector. These Industry Standard connectors are backed by Harwin's outstanding service, quality and distribution network, and are an ideal choice for a miniature alternative to larger pin header and socket connections.

- ❖ M50 – Single and Double row pin headers and sockets, in vertical and horizontal orientations, for board-to-board connections. 1.27mm (0.05") pitch in both directions, with 0.4mm square male pins. Jumper Sockets and Pin Header Variants also available.
- ❖ M50 Polarised – Double row connectors for board-to-board, with added shrouding and a polarisation feature.
- ❖ M50 IDC – Cable connectors for 0.635mm pitch ribbon cable, and associated board connectors with securing latches and polarisation, for cable-to-board connection. Complete cable assemblies also supplied as standard.
- ❖ M52 – Single and Double row pin headers and sockets, in vertical and horizontal orientations, for board-to-board connections. 1.27mm (0.05") pitch along the connector, 2.54mm (0.1") between connector rows using 0.46mm square male pins. Pin Header Variants also available.

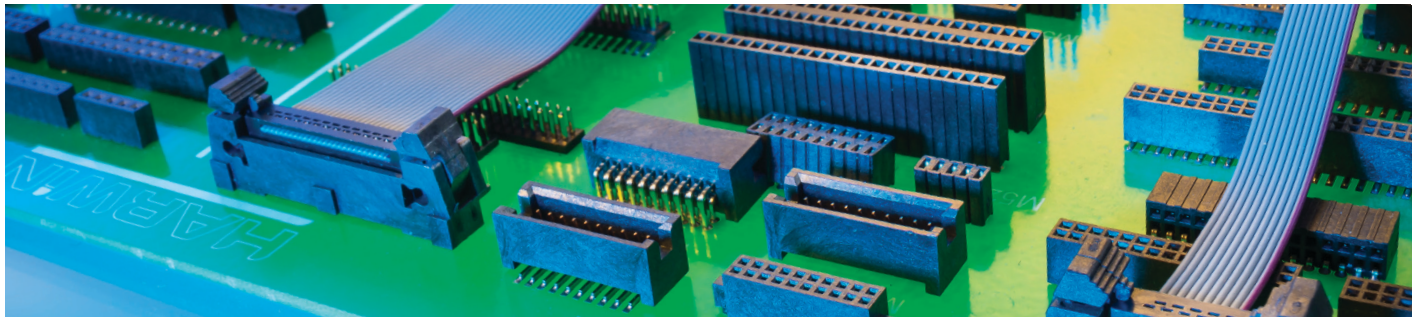

Archer Kontrol

1.27mm pitch durable, rugged board-to-board connectors. Available in a choice of orientations and mating heights, these connectors add a tougher option to the Archer family. Due to the fully shrouded design, these connectors are suited for blind-mating applications. They can withstand lateral and twisting forces, and tolerate a significant amount of mis-alignment.

- ❖ Current rating of 1.2A per contact.
- ❖ Vertical and Horizontal options in both male and female connectors – board-to-board connection for parallel/mezzanine, motherboard to daughterboard, or coplanar/edge-to-edge PCB layouts.
- ❖ Variable stacking height options with multiple connector sizes in both genders.
- ❖ Enhanced durability of 500 mating cycles minimum.
- ❖ Additional strain relief with retaining SMT tabs.
- ❖ Supplied in tape and reel, with pick-and-place caps where required, for automated assembly.
- ❖ Increased operating temperature range: -55°C to +125°C.

Archer Kontrol offers the ideal connection system for demanding industrial environments:

- ❖ Drives and controls
- ❖ Dataloggers
- ❖ IOT installations
- ❖ Vehicle control systems
- ❖ Trackside monitoring equipment
- ❖ Large scale factory installations

Archer Kontrol Specification

Materials

Mouldings:	High Temperature Plastic UL94V-0
Contacts:	Phosphor Bronze
Retaining strap:	Brass
Finish:	See individual pages
Contacts:	Gold on contact area, Tin on tails
Retaining strap:	Tin

Electrical

Current:	1.2A max per contact
Voltage proof:	500V AC for 1 minute
Contact resistance:	25mΩ max
Insulation resistance:	10GΩ min

Mechanical

Durability:	500 operations
Insertion force (max):	0.8N per contact
Withdrawal force (min):	0.2N per contact

Environmental

Operating temperature:	-55°C to +125°C
Vibration sensitivity:	10Hz to 2000Hz, 1.52mm, 196m/s ² (20G), duration 12h
Solderability:	245°C for 5 seconds
Soldering heat resistance:	260°C for 10 seconds

1.27mm (.050") PITCH

Pin Numbering

FEMALE	MALE
<p>Diagram of a female connector showing pin numbering: a1, b1, a10, b10.</p>	<p>Diagram of a male connector showing pin numbering: a10, b10, a1, b1.</p>

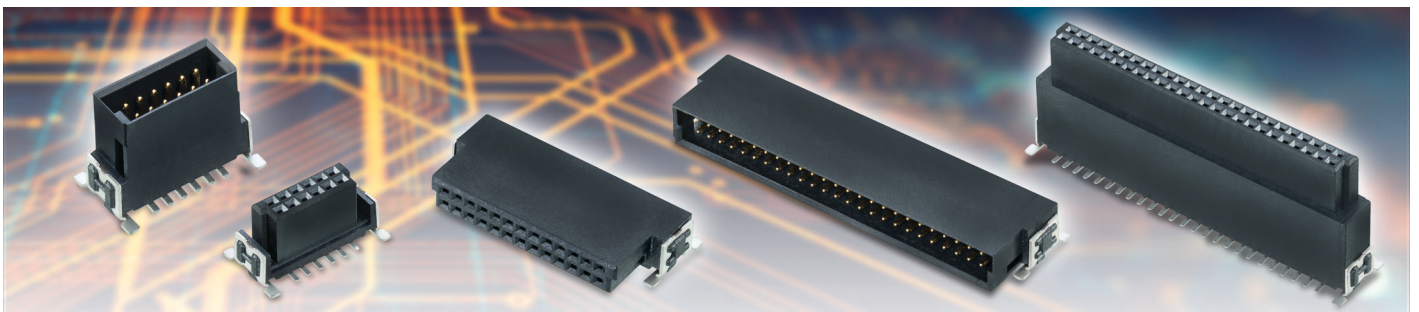

Archer Kontrol Mating Profiles

❖ Mating heights shown in fully mated condition. Product can be used up to 1.5mm separated and still perform to the same specifications.

1.27mm (.050") PITCH

		FEMALE			
		VERTICAL SMT			HORIZONTAL SMT
		6.25mm HEIGHT	9.05mm HEIGHT	13.65mm HEIGHT	
MALE	VERTICAL SMT	<p>8.00</p>	<p>10.80</p>	<p>15.40</p>	<p>12.55</p>
	<p>9.50</p>	<p>12.30</p>	<p>16.90</p>	<p>14.05</p>	
	<p>11.10</p>	<p>13.90</p>	<p>18.50</p>	<p>15.65</p>	
	HORIZONTAL SMT	<p>11.25</p>	<p>14.05</p>	<p>18.65</p>	<p>15.80</p>

All dimensions in mm.

Archer Kontrol Connectors

Female Vertical Surface Mount

- ❖ Suitable for parallel board-to-board (mezzanine stacking) or motherboard-to-daughterboard configurations.
- ❖ Choice of three height options.
- ❖ Polarised and shrouded housing design.
- ❖ Location pegs and tape & reel packaging for automated assembly processes.

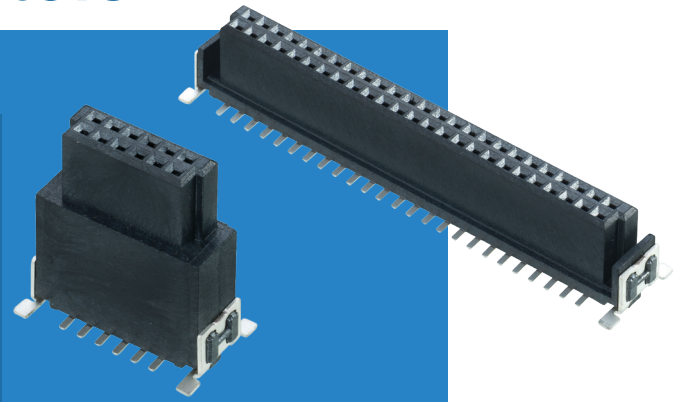

1.27mm (.050") PITCH

VERTICAL

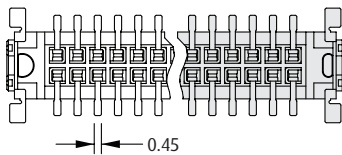
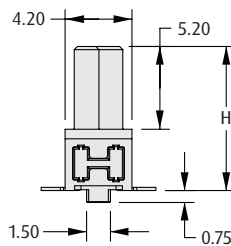
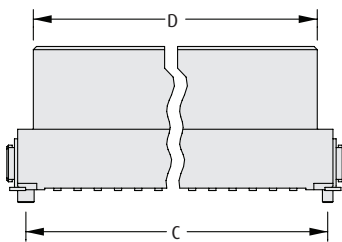
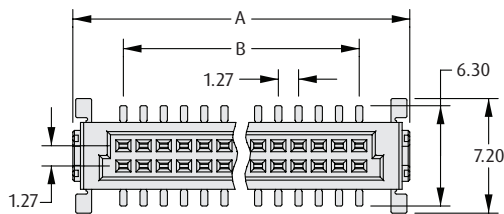

CALCULATION

A	$B + 6.35$
B	$0.635 \times (\text{Total No. of contacts} - 2)$
C	$B + 4.42$
D	$B + 3.02$

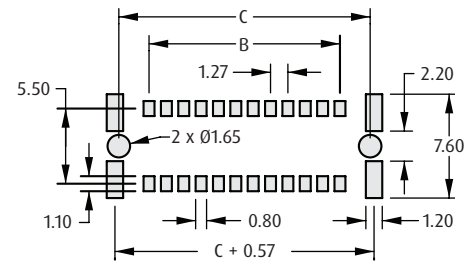

Recommended PC Board Pattern

HOW TO ORDER

M55 - 60 X XX 42 R

SERIES CODE

CONNECTOR HEIGHT

0	H = 6.25mm
1	H = 9.05mm
2	H = 13.65mm

PACKAGING

R Tape & Reeled

FINISH

42 Gold + Tin

TOTAL NO. OF CONTACTS

12, 16, 20, 26, 32, 40, 50, 68, 80

All dimensions in mm.

Archer Kontrol Connectors

Female Horizontal Surface Mount

- ❖ Suitable for coplanar (edge-to-edge) or motherboard-to-daughterboard configurations.
- ❖ Hold-down SMT retaining straps for additional retention to the board.
- ❖ Polarised and shrouded housing design.
- ❖ Location pegs and tape & reel packaging for automated assembly processes.

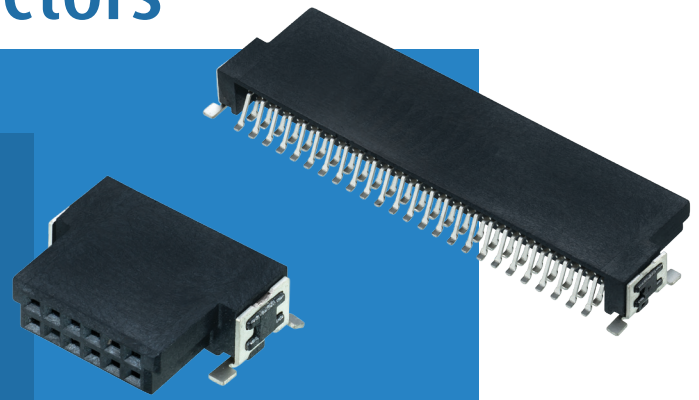

1.27mm (.050") PITCH

HORIZONTAL

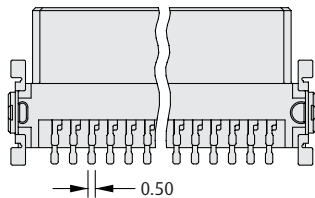
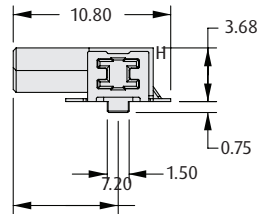
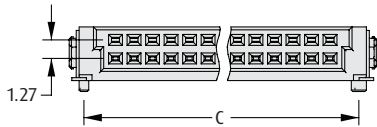
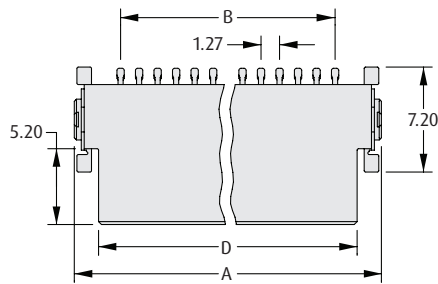

CALCULATION

A	$B + 6.35$
B	$0.635 \times (\text{Total No. of contacts} - 2)$
C	$B + 4.42$
D	$B + 3.02$

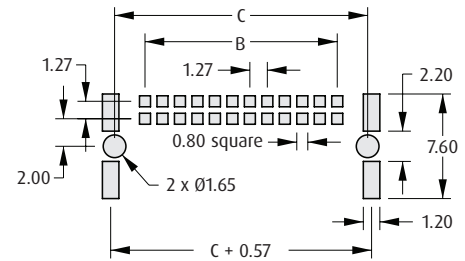

Recommended PC Board Pattern

HOW TO ORDER

M55 - 610 XX 42 R

SERIES CODE

PACKAGING

R Tape & Reeled

FINISH

42 Gold + Tin

TOTAL NO. OF CONTACTS

12, 16, 20, 26, 32, 40, 50, 68, 80

All dimensions in mm.

Archer Kontrol Connectors

Male Vertical Surface Mount

- ❖ Suitable for parallel board-to-board (mezzanine stacking) or motherboard-to-daughterboard configurations.
- ❖ Choice of three height options.
- ❖ Polarised and shrouded housing design.
- ❖ Location pegs and tape & reel packaging for automated assembly processes.

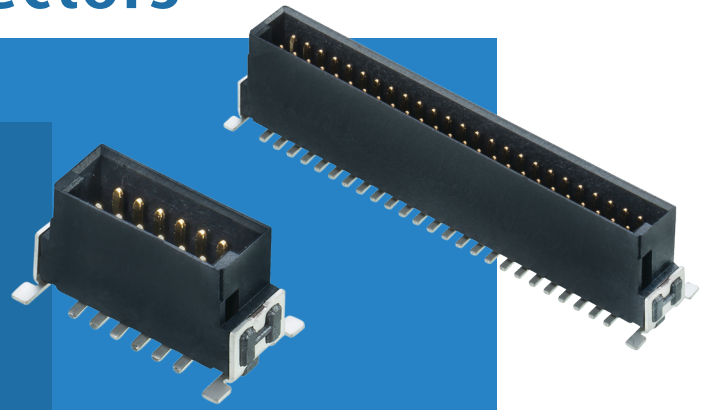

1.27mm (.050") PITCH

VERTICAL

CALCULATION

A	$B + 6.35$
B	$0.635 \times (\text{Total No. of contacts} - 2)$
C	$B + 4.42$
D	$B + 4.02$

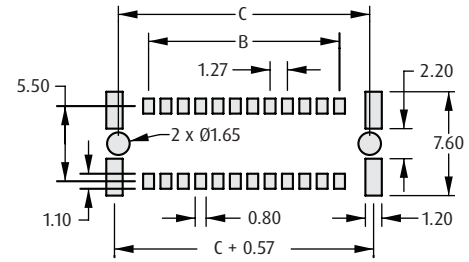
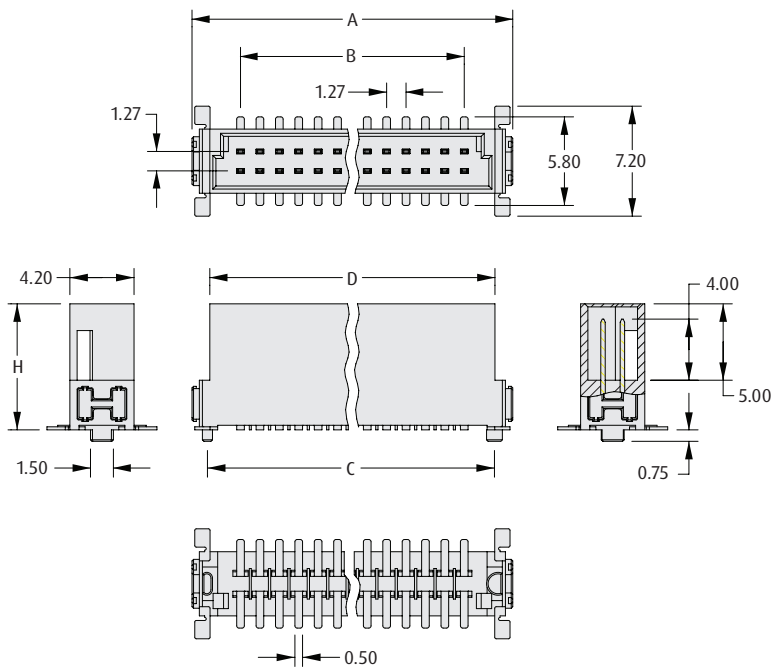

Recommended PC Board Pattern

HOW TO ORDER

M55 - 70 X XX 42 R

SERIES CODE

CONNECTOR HEIGHT

0	H = 6.75mm
1	H = 8.25mm
2	H = 9.85mm

PACKAGING

R Tape & Reeled

FINISH

42 Gold + Tin

TOTAL NO. OF CONTACTS

12, 16, 20, 26, 32, 40, 50, 68, 80

All dimensions in mm.

Archer Kontrol Connectors

Male Horizontal Surface Mount

- ❖ Suitable for coplanar (edge-to-edge) or motherboard-to-daughterboard configurations.
- ❖ Hold-down SMT retaining straps for additional retention to the board.
- ❖ Polarised and shrouded housing design.
- ❖ Location pegs and tape & reel packaging for automated assembly processes.

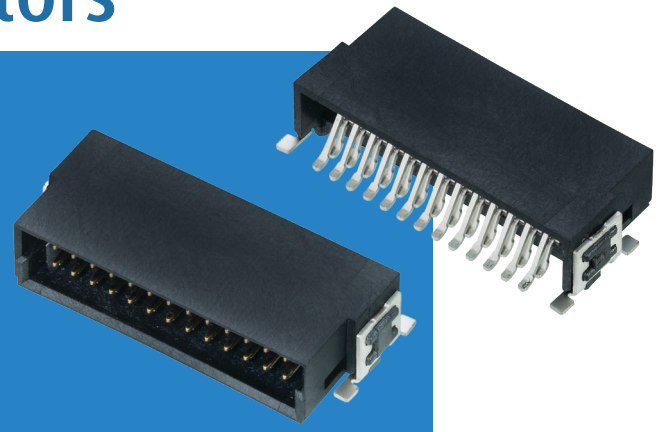

1.27mm (.050") PITCH

HORIZONTAL

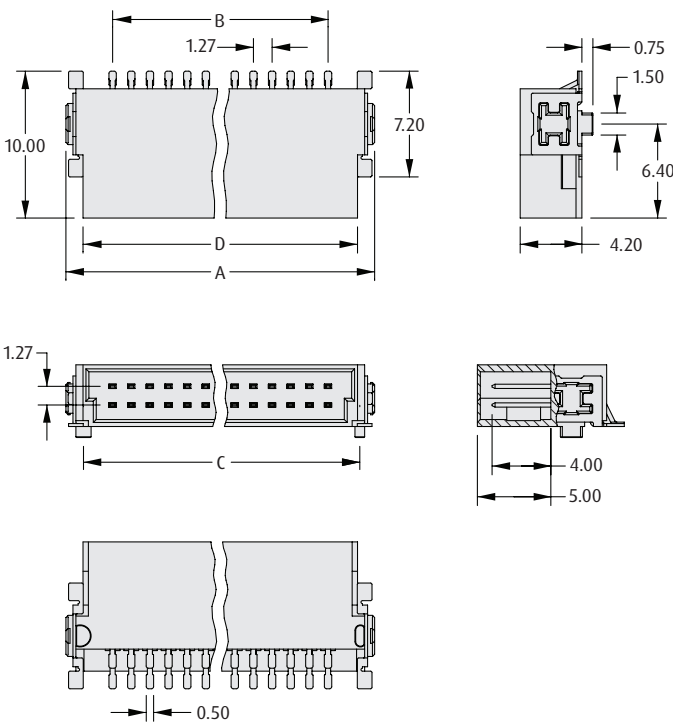

CALCULATION

A	$B + 6.35$
B	$0.635 \times (\text{Total No. of contacts} - 2)$
C	$B + 4.42$
D	$B + 4.02$

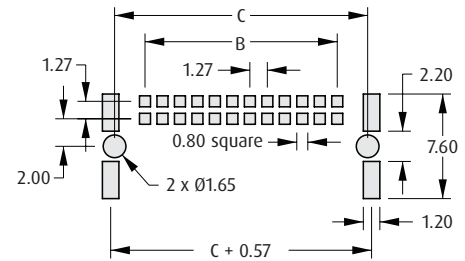

Recommended PC Board Pattern

HOW TO ORDER

M55 - 710 XX 42 R

SERIES CODE

PACKAGING

R Tape & Reeled

FINISH

42 Gold + Tin

TOTAL NO. OF CONTACTS

12, 16, 20, 26, 32, 40, 50, 68, 80

All dimensions in mm.

Archer Connectors - M50 Specification

❖ 1.27mm pitch male pin headers (with 0.4mm square pins) and female sockets, for board-to-board connection.

❖ Materials

Mouldings:	High Temperature Plastic UL94V-0
Contacts:	Copper Alloy
Finish:	See individual pages

❖ Electrical

Current:	1A per contact
Voltage proof:	300V AC, 500V DC for 1 minute (see individual drawings)
Contact resistance:	30mΩ max
Insulation resistance:	500MΩ min

❖ Mechanical

Durability	
M50-310, 312, 491:	100 operations
M50-311:	600 operations
M50-315:	25 operations
M50-353, 363, 393:	500 operations
Others:	300 operations
Insertion force (max)	
M50-303, 313, 314:	1.17N per contact
Jumper sockets:	10.0N
Others:	2.0N per contact
Withdrawal force (min)	
Jumper sockets:	1.3N
Others:	0.1N per contact
Vibration sensitivity:	10 - 55Hz, 1.5mm, 6 hours duration
Shock severity:	294m/s ² (30G) for 11ms

❖ Environmental

Operating temperature:	-40°C to +105°C
Solderability:	245°C for 5 seconds
Soldering heat resistance:	260°C for 5 seconds

1.27mm (.050") PITCH

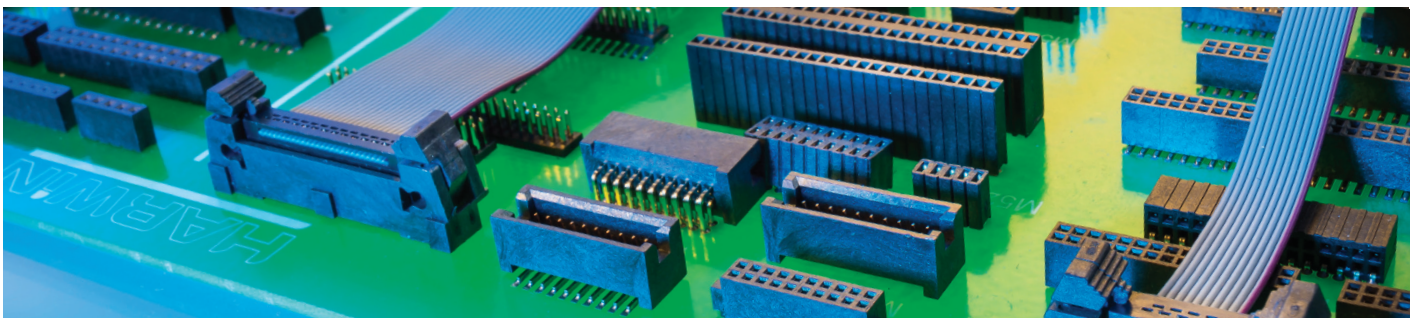

Archer Connectors - M50 Mating Profiles

1.27mm (.050") PITCH

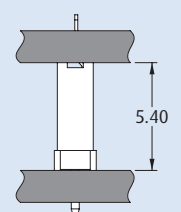
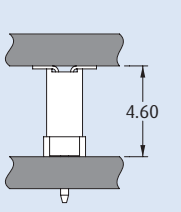
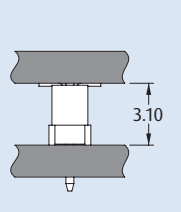
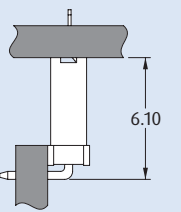
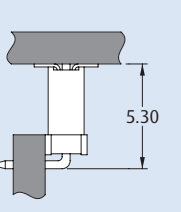
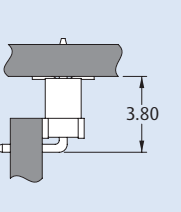
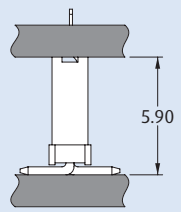
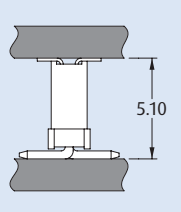
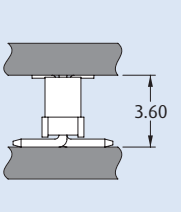
SINGLE ROW		FEMALE		
		VERTICAL PC TAIL	VERTICAL SMT	VERTICAL SMT Low Profile
MALE	VERTICAL PC TAIL	 5.40	 4.60	 3.10
	HORIZONTAL PC TAIL	 6.10	 5.30	 3.80
	VERTICAL SMT	 5.90	 5.10	 3.60

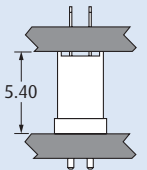
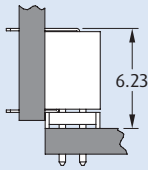
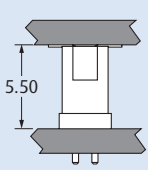
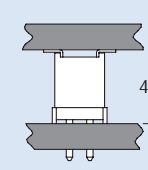
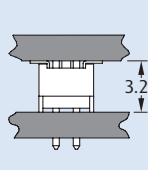
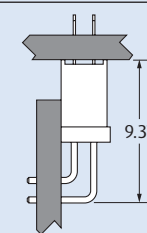
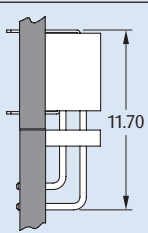
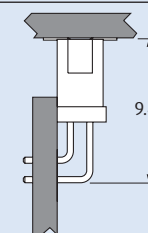
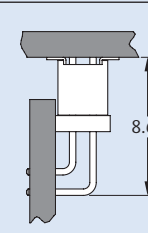
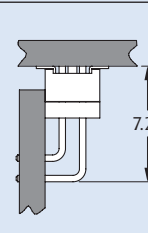
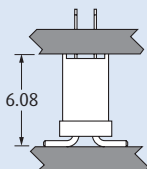
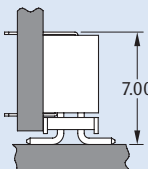
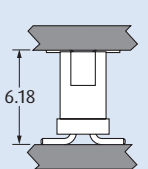
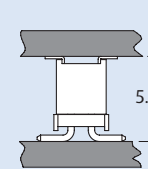
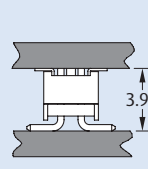
DOUBLE ROW		FEMALE				
		VERTICAL PC TAIL	HORIZONTAL PC TAIL	VERTICAL SMT	VERTICAL SMT Low Profile	
MALE	VERTICAL PC TAIL	 5.40	 6.23	 5.50	 4.60	 3.20
	HORIZONTAL PC TAIL	 9.37	 11.70	 9.47	 8.60	 7.20
	VERTICAL SMT	 6.08	 7.00	 6.18	 5.30	 3.90

All dimensions in mm.

Archer Connectors – M50

Female PC Tail Vertical

▸ Twin beam connector for higher durability.

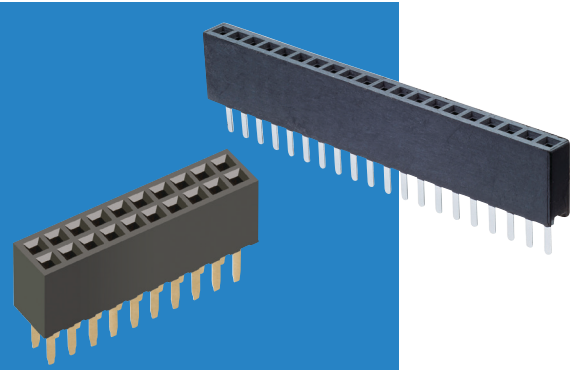

1.27mm (.050") PITCH

SINGLE ROW

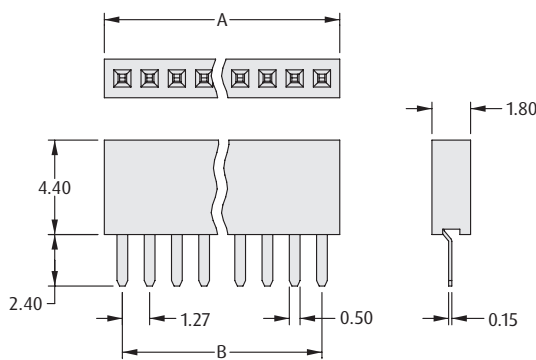

CALCULATION

A	$B + 1.67$
B	$1.27 \times (\text{No. of contacts per row} - 1)$

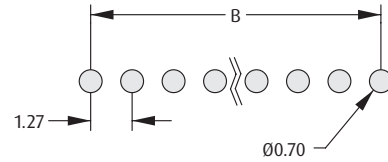

Recommended PC Board Pattern

DOUBLE ROW

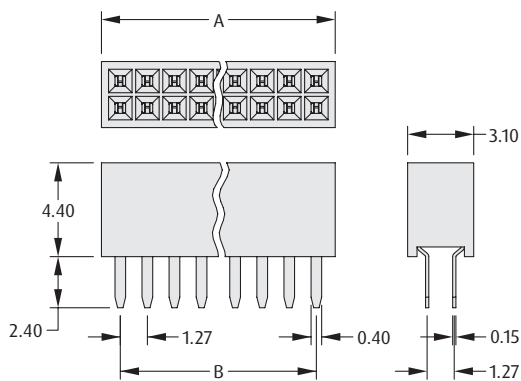

CALCULATION

A	$B + 1.77$
B	$1.27 \times (\text{No. of contacts per row} - 1)$

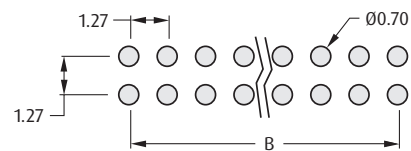

Recommended PC Board Pattern

HOW TO ORDER

M50 - 3 0 X XX XX

SERIES CODE

TYPE

0	Double Row
3	Single Row

FINISH

42	Gold + Tin (Single Row)
45	Gold (Double Row)

NO. OF CONTACTS PER ROW

02 to 06, 08, 10, 20	Single Row
03 to 15, 20, 25, 50	Double Row

All dimensions in mm.

Archer Connectors – M50

Female PC Tail Horizontal

- Horizontal connector has two point solder fixing for connector rigidity.
- Twin beam connector for higher durability.

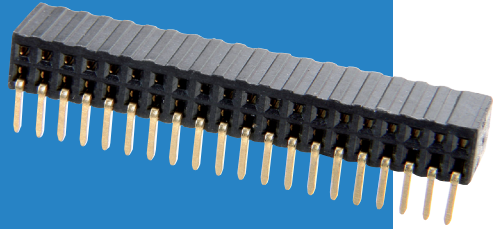

1.27mm (.050") PITCH

HORIZONTAL

CALCULATION

A	$B + 1.77$
B	$1.27 \times (\text{No. of contacts per row} - 1)$

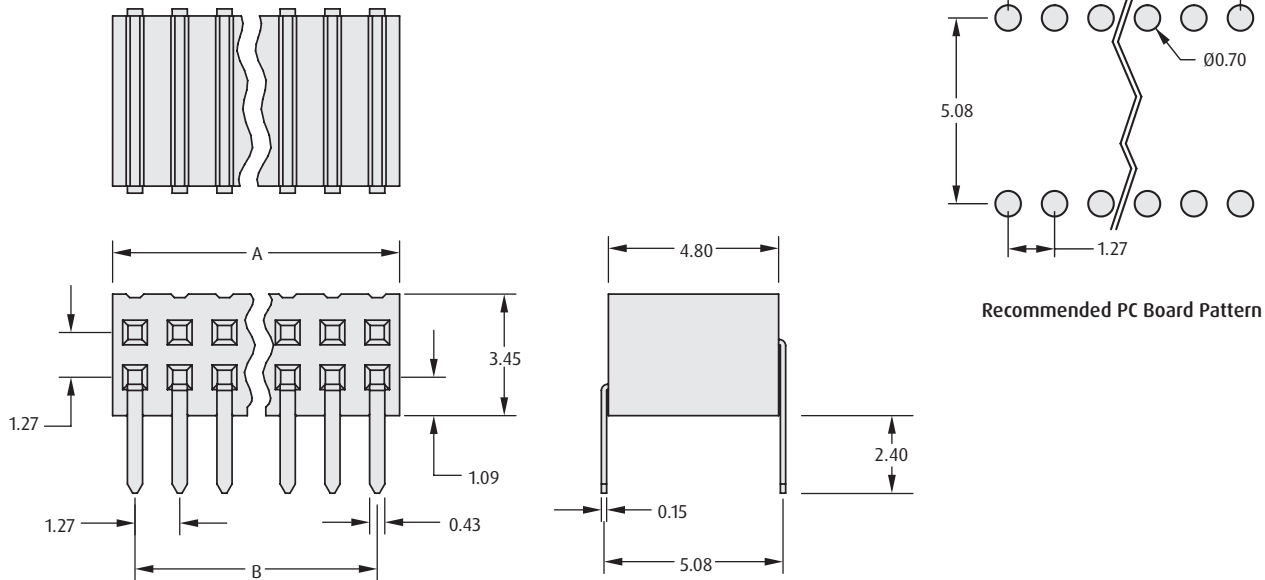

Recommended PC Board Pattern

HOW TO ORDER

M50 - 320 XX 45

SERIES CODE

FINISH

45 Gold

NO. OF CONTACTS PER ROW

03 to 15, 20, 25

All dimensions in mm.

Archer Connectors – M50

Female Vertical Surface Mount

- ❖ Locating pegs (posts) available to ensure correct positioning on the board.
- ❖ Alternative height connectors available on the following page.
- ❖ Contact technical@harwin.com for Tape and Reel options.
- ❖ Dual entry connector can be used as either top or bottom entry.

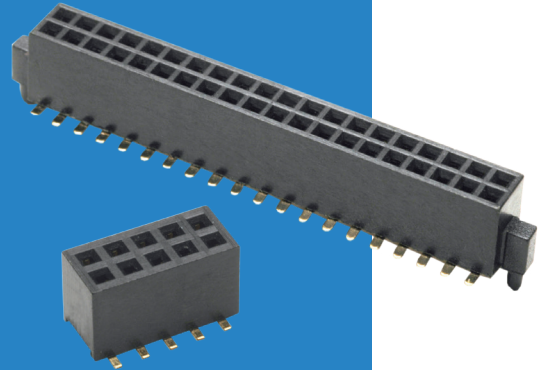

1.27mm (.050") PITCH

WITHOUT POST

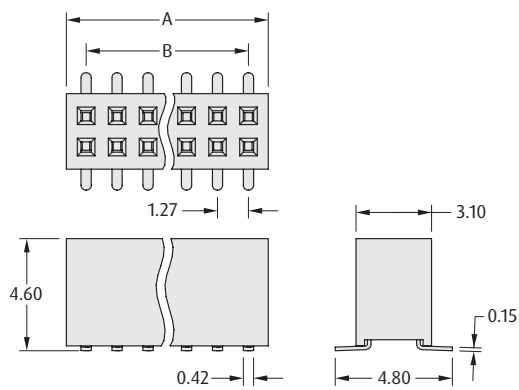

CALCULATION

A	$B + 1.62$
B	$1.27 \times (\text{No. of contacts per row} - 1)$

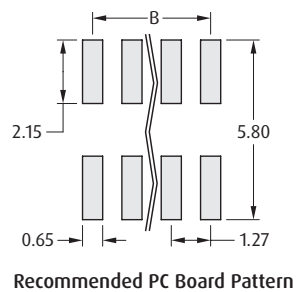

WITH POST, DUAL ENTRY

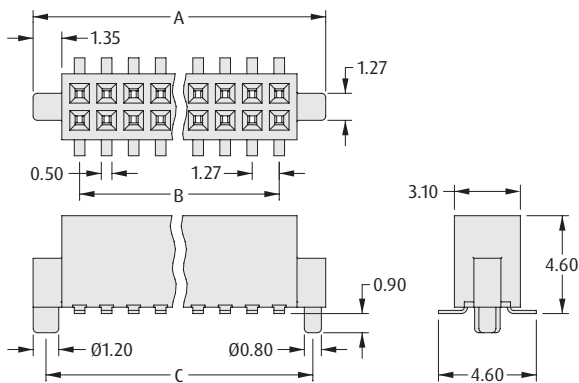

CALCULATION

A	$B + 4.37$
B	$1.27 \times (\text{No. of contacts per row} - 1)$
C	$B + 3.16$

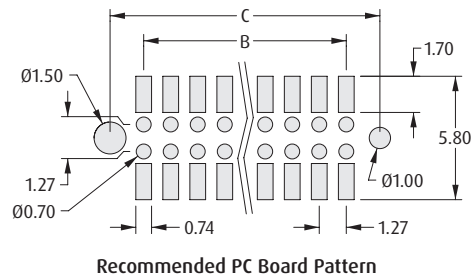

HOW TO ORDER

M50 - 31 X XX XX

SERIES CODE

TYPE

0	Without Posts
1	With Posts

FINISH

42	Gold + Tin (With Posts)
45	Gold (Without Posts)

NO. OF CONTACTS PER ROW

03 to 15, 20, 25, 50	Without Posts
03 to 15, 20, 25, 30	With Posts

All dimensions in mm.

Archer Connectors – M50

Female Vertical Surface Mount, Low Profile

- Lower profile surface mount connector with twin beam contacts for additional board-to-board height options.
- Contact technical@harwin.com for Tape and Reel options.

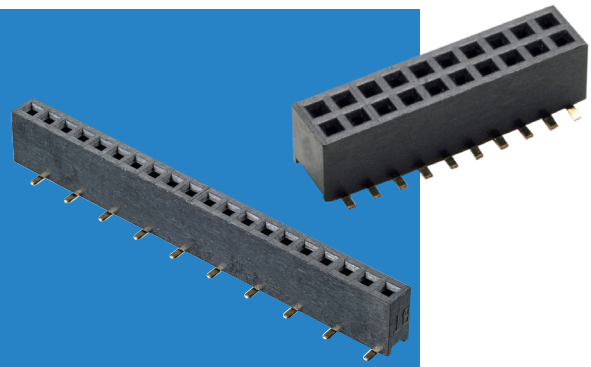

1.27mm (.050") PITCH

SINGLE ROW

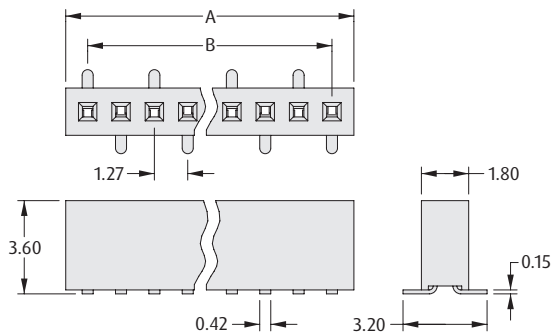

CALCULATION

A	$B + 1.67$
B	$1.27 \times (\text{No. of contacts per row} - 1)$

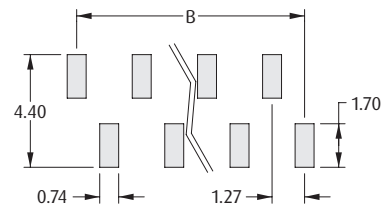

Recommended PC Board Pattern

DOUBLE ROW

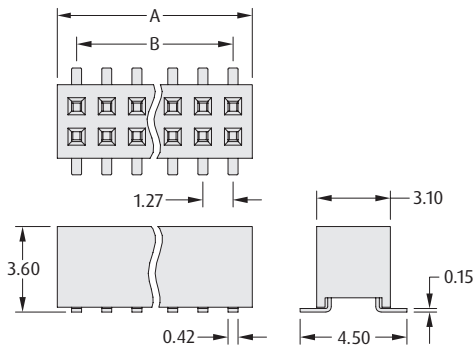

CALCULATION

A	$B + 1.73$
B	$1.27 \times (\text{No. of contacts per row} - 1)$

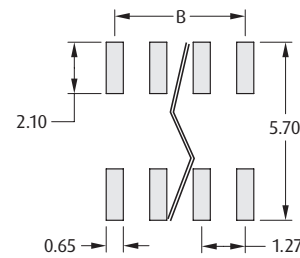

Recommended PC Board Pattern

HOW TO ORDER

M50 - 31 X XX XX X

SERIES CODE

TYPE

2	Double Row
4	Single Row

PACKAGING

R	Tape & Reeled (Single Row)
Blank	Loose

FINISH

45	Gold
-----------	------

NO. OF CONTACTS PER ROW

03 to 15, 20, 25, 30, 50	Double Row
02 to 06, 08, 10, 20	Single Row

All dimensions in mm.

Archer Connectors – M50

Female Vertical Surface Mount, Low Profile

- ❏ Locating pegs (posts) available on double row to ensure correct positioning on the board.
- ❏ Dual entry connectors can be used as either top or bottom entry.
- ❏ Contact technical@harwin.com for Tape and Reel options on double row.

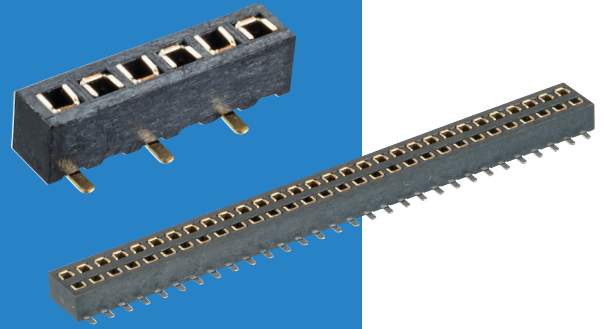

1.27mm (.050") PITCH

SINGLE ROW

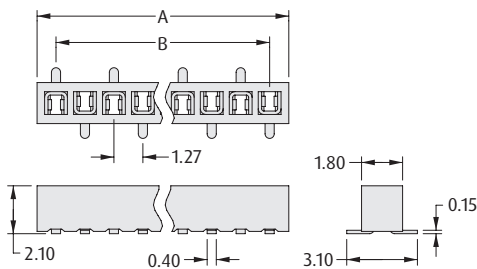

CALCULATION

A	$B + 1.67$
B	$1.27 \times (\text{No. of contacts per row} - 1)$

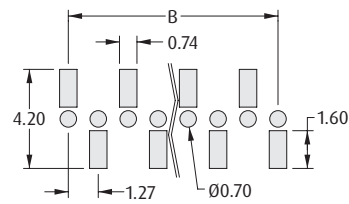

Recommended PC Board Pattern

DOUBLE ROW WITH POSTS

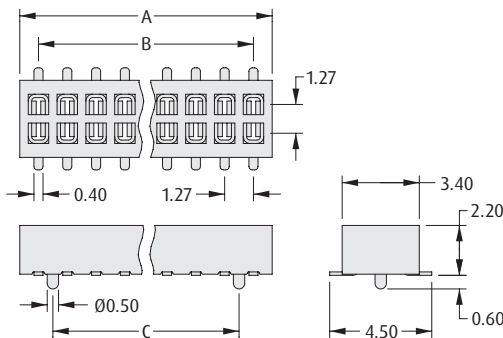

CALCULATION

A	$B + 1.67$
B	$1.27 \times (\text{No. of contacts per row} - 1)$
C	$B + 1.27$

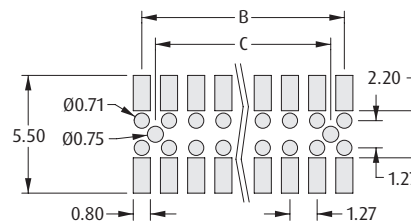

Recommended PC Board Pattern

HOW TO ORDER

M50 - 31 X XX XX X

SERIES CODE

TYPE

3	Single Row (without posts)
5	Double Row with posts

PACKAGING

R	Tape & Reeled (Single Row)
Blank	Loose

FINISH

42	Gold + Tin (Double Row)
45	Gold (Single Row)

NO. OF CONTACTS PER ROW

02 to 06, 08, 10, 20	Single Row
03 to 15, 20, 22, 25, 30	Double Row

All dimensions in mm.

Archer Connectors – M50

Jumper Sockets

- ❖ Can be fitted and removed by hand, giving an alternative on-board programming method to DIP switches.
- ❖ Suitable for use with male M50 pin headers.
- ❖ Choice of colours available.
- ❖ Closed top with handle available for easier handling, placing and removing.

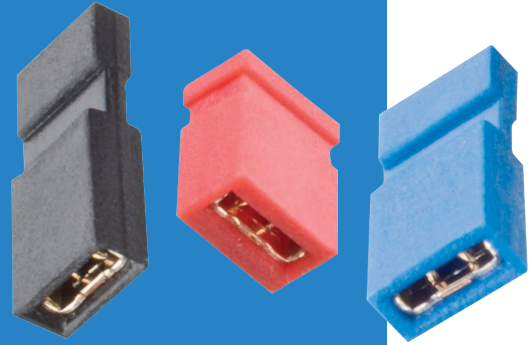

1.27mm (.050") PITCH

CLOSED TOP

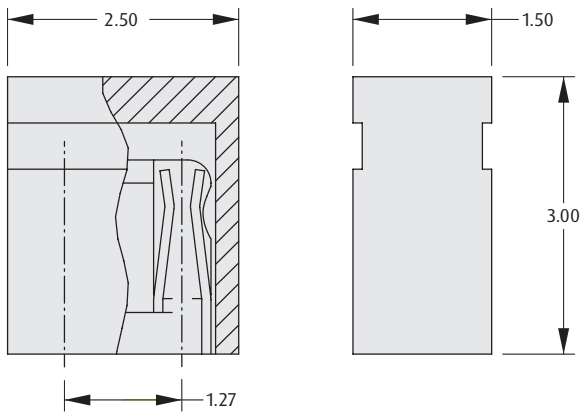

CLOSED TOP WITH HANDLE

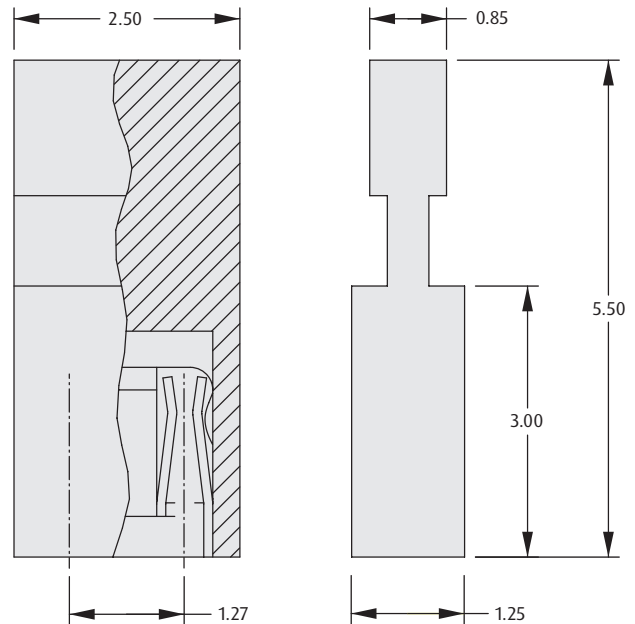

HOW TO ORDER

M50 XXX 00 05

SERIES CODE

TYPE			
Closed Top		Closed Top with Handle	
190	Black	200	Black
192	Red	202	Red
193	Blue	203	Blue

FINISH

05 Gold

All dimensions in mm.

Archer Connectors – M50

Male PC Tail Vertical

- Suitable for use with female connectors and jumper sockets.
- Also available with variable dimensions.

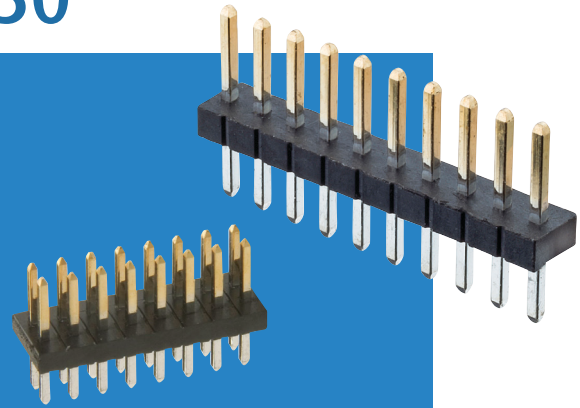

1.27mm (.050") PITCH

SINGLE ROW

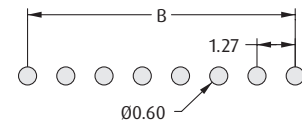
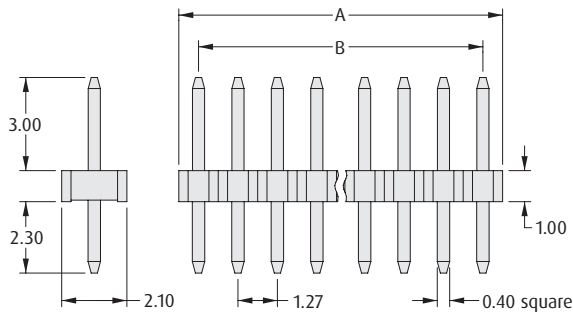

Recommended PC Board Pattern

CALCULATION

A	1.27 x No. of contacts per row
B	1.27 x (No. of contacts per row - 1)

DOUBLE ROW

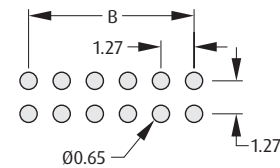
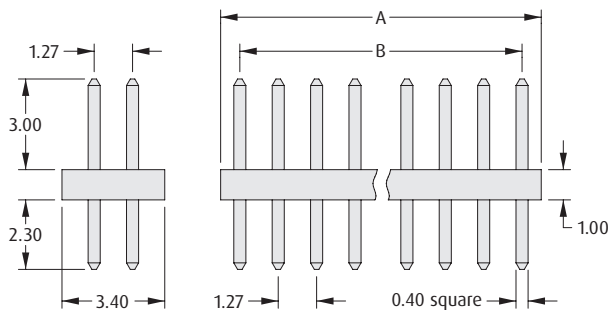

Recommended PC Board Pattern

HOW TO ORDER

M50 - 35 X XX 42

SERIES CODE

TYPE

0	Double Row
3	Single Row

FINISH

42 Gold + Tin

NO. OF CONTACTS PER ROW

02 to 15, 20, 25, 50	Double Row
02 to 06, 08, 10, 20	Single Row

All dimensions in mm.

Archer Connectors – M50

Male PC Tail Horizontal

- Suitable for use with female connectors and jumper sockets.
- Also available with variable dimensions.

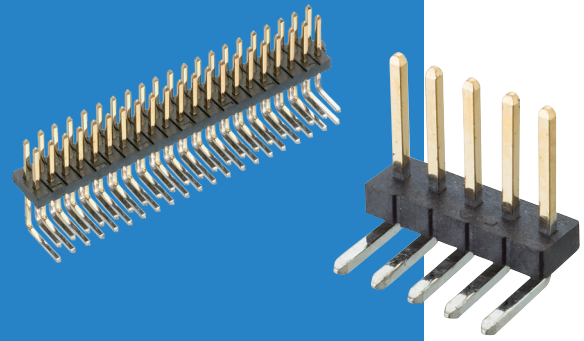

1.27mm (.050") PITCH

SINGLE ROW

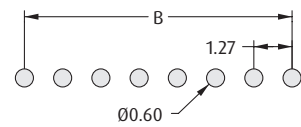
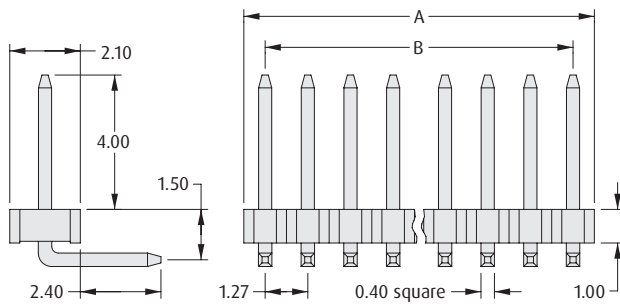

Recommended PC Board Pattern

CALCULATION

A	1.27 x No. of contacts per row
B	1.27 x (No. of contacts per row - 1)

DOUBLE ROW

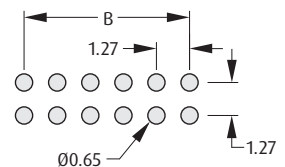
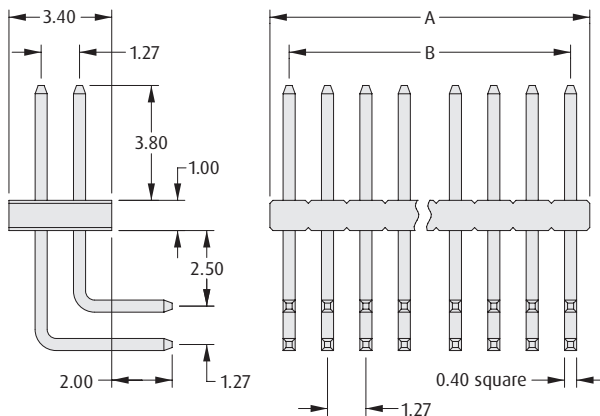

Recommended PC Board Pattern

HOW TO ORDER

M50 - 39 X XX 42

SERIES CODE

TYPE

0	Double Row
3	Single Row

FINISH

42 Gold + Tin

NO. OF CONTACTS PER ROW

02 to 15, 20, 25	Double Row
02 to 06, 08, 10, 20	Single Row

All dimensions in mm.

Archer Connectors – M50

Male Vertical Surface Mount Single Row

- ❖ Suitable for use with female connectors and jumper sockets.
- ❖ Tape and Reel packaging option includes Pick and Place cap for automated assembly.

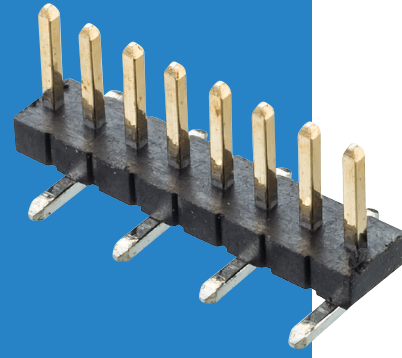

1.27mm (.050") PITCH

SINGLE ROW

CALCULATION

A	1.27 x No. of contacts per row
B	1.27 x (No. of contacts per row - 1)

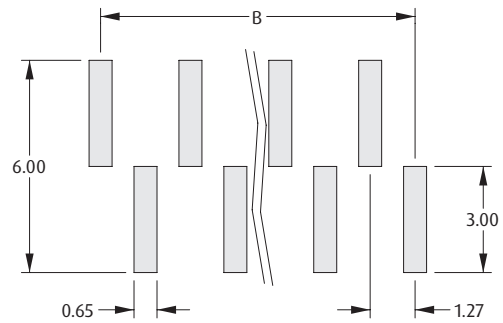
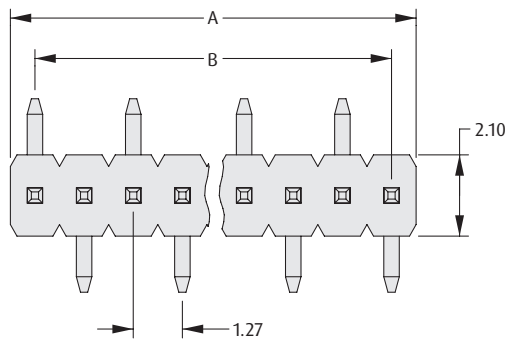

Recommended PC Board Pattern

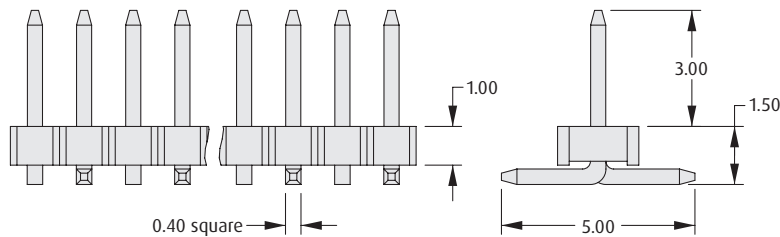

HOW TO ORDER

M50 - 363 XX 42 X

SERIES CODE

NO. OF CONTACTS PER ROW

02 to 06, 08, 10, 20

PACKAGING

Blank	Loose
R	Tape & Reeled

FINISH

42	Gold + Tin
-----------	------------

All dimensions in mm.

Archer Connectors – M50

1.27mm (.050") PITCH

Male Vertical Surface Mount Double Row

- ❖ Suitable for use with female connectors and jumper sockets.
- ❖ Also available with variable dimensions.
- ❖ Available with or without location posts.
- ❖ Tape and Reel packaging option includes Pick and Place cap for automated assembly.

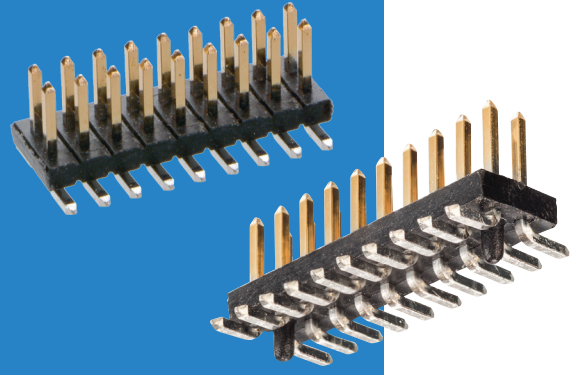

WITHOUT POSTS

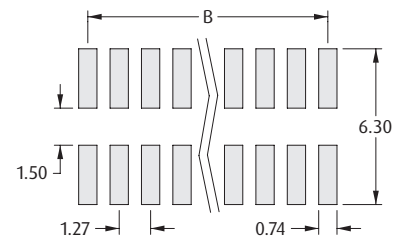
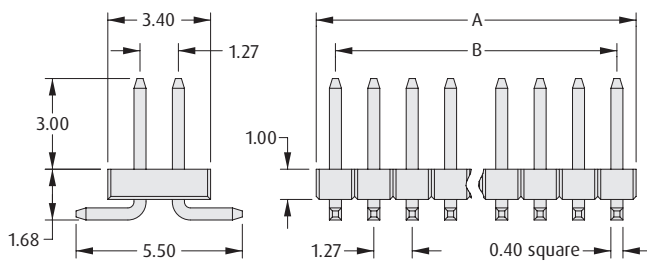

Recommended PC Board Pattern

CALCULATION

A	1.27 x No. of contacts per row
B	1.27 x (No. of contacts per row - 1)

WITH POSTS

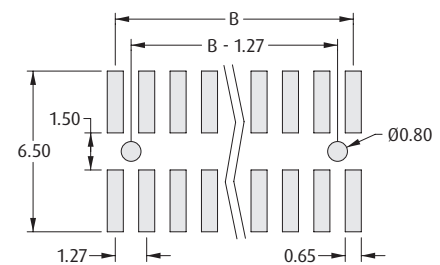
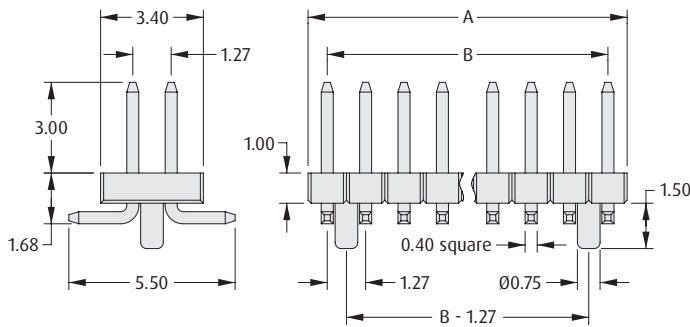

Recommended PC Board Pattern

HOW TO ORDER

M50 - 36 X XX 42 X

SERIES CODE

TYPE

0	Without Posts
1	With Posts

NO. OF CONTACTS PER ROW

02 to 15, 20, 25	Without Posts
05 to 08, 10, 12, 15, 20, 25	With Posts

PACKAGING

Blank	Loose
R	Tape & Reeled (check website for available sizes)

FINISH

42	Gold + Tin
-----------	------------

All dimensions in mm.

Archer Connectors – M50

Pin Header Variants

- ❖ If you are unable to specify the connector you require from our standard range of Archer M50 connectors, use the order code below to create an application-specific connector.
- ❖ Contact technical@harwin.com for further information, or search online for M50-XXX.
- ❖ Suitable for use with female connectors and jumper sockets.

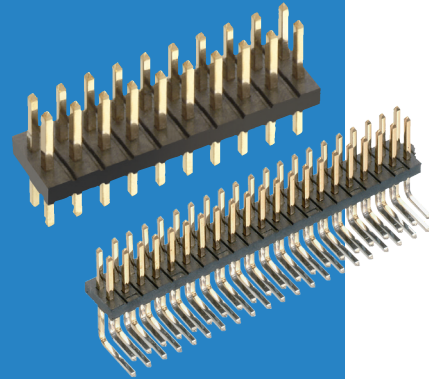

1.27mm (.050") PITCH

TERMINATION STYLES

Vertical PC Tail W Series

- ❖ Pin section is 0.40mm square.
- ❖ PCB mounting hole is $\varnothing 0.65\text{mm}$.

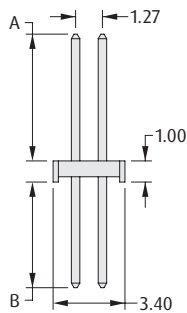

Extended PC Tail F Series

- ❖ Pin section is 0.40mm square.
- ❖ PCB mounting hole is $\varnothing 0.65\text{mm}$.

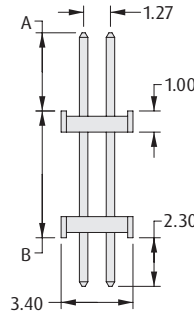

Vertical SMT S Series

- ❖ Pin section is 0.40mm square.
- ❖ For PCB pad layout see standard Male SMT pin header.
- ❖ B dimension is 000.

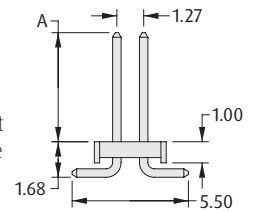

Extended SMT T Series

- ❖ Pin section is 0.40mm square.
- ❖ For PCB pad layout see standard Male SMT pin header.
- ❖ $A+B+0.68$ not to exceed 24.3mm.

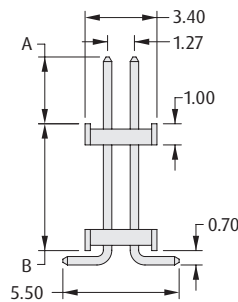

Horizontal PC Tail J Series

- ❖ Pin section is 0.40mm square.
- ❖ PCB mounting hole is $\varnothing 0.65\text{mm}$.

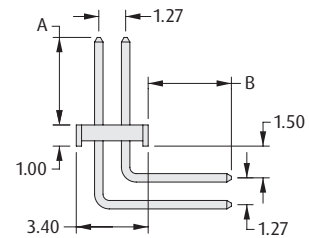

HOW TO ORDER

M50 - XXX XXX X XX 45

SERIES CODE

DIMENSION A

Example: 7.8mm = 078

DIMENSION B

Example: 5.0mm = 050

FINISH

45

Gold

NO. OF CONTACTS PER ROW

01 to 50

TYPE

W	Vertical PC Tail
F	Extended PC Tail
S	Vertical SMT
T	Extended SMT
J	Horizontal PC Tail

All dimensions in mm.

Archer Connectors – Polarised Specification

❖ 1.27mm pitch male and female connectors, for board-to-board connection with polarisation.

❖ Materials

Mouldings:	High Temperature Plastic UL94V-0
Contacts:	Copper Alloy
Finish:	Gold

❖ Mechanical

Durability:	100 operations
Insertion force (max):	2.0N per contact
Withdrawal force (min):	0.15N per contact

❖ Electrical

Current:	1A per contact
Voltage proof:	300V AC, 500V DC for 1 minute
Contact resistance:	30mΩ max
Insulation resistance:	500MΩ min

❖ Environmental

Operating temperature:	-40°C to +105°C
Solderability:	245°C for 5 seconds
Soldering heat resistance:	260°C for 10 seconds

Mating Profiles

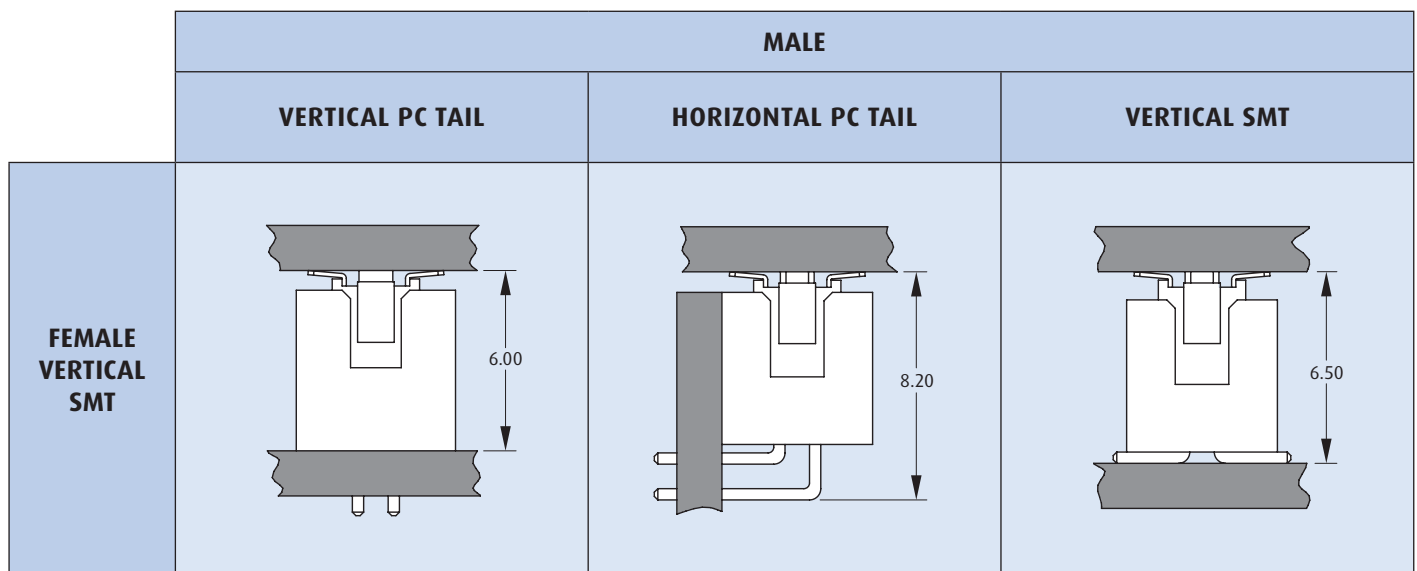

All dimensions in mm.

Archer Connectors – Polarised

1.27mm (.050") PITCH

Vertical Surface Mount

- Mating connectors in Surface Mount format.
- Female connector is also suitable for use with male PC Tail connectors on the following page.
- Polarisation to prevent mis-mating.
- Locating pegs of different sizes ensure correct orientation and positioning on the board.
- Shrouded for additional pin protection.

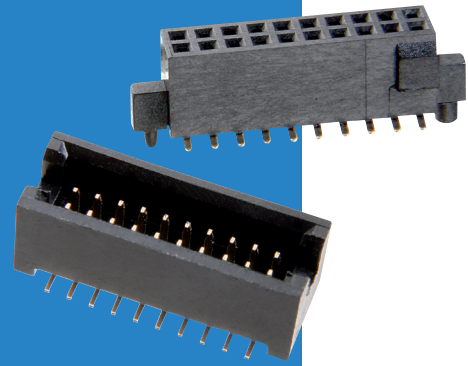

FEMALE	CALCULATION
	A B + 1.62
	B 1.27 x (No. of contacts per row - 1)
<p style="text-align: center;">Recommended PC Board Pattern</p>	C B + 3.15
	D B + 5.02

MALE	CALCULATION
	A B + 4.47
	B 1.27 x (No. of contacts per row - 1)
<p style="text-align: center;">Recommended PC Board Pattern</p>	C B + 3.15

HOW TO ORDER

M50 - 4XX XX 45 X

SERIES CODE

TYPE	
430	Female
490	Male without pegs
491	Male with pegs

NO. OF CONTACTS PER ROW

03 to 15, 19, 20, 25, 50	Female
05 to 15, 20, 25, 50	Male without pegs
05 to 08, 10, 12, 15, 20, 25	Male with pegs

PACKAGING

Blank	Loose
R	Tape & Reeled (check website for available sizes)

FINISH

45 Gold

All dimensions in mm.

Archer Connectors – Polarised

Male PC Tail

- ❖ PC Tail male connectors suitable for use with female connector M50-430 Series, shown on previous page.
- ❖ Polarisation to prevent mis-mating.
- ❖ Shrouded for additional pin protection.

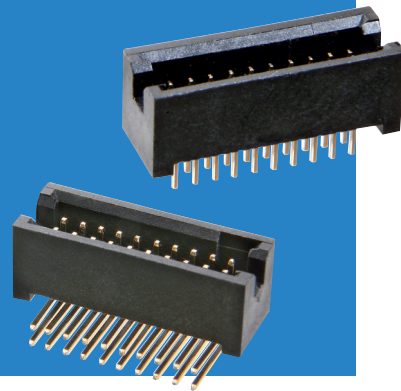

1.27mm (.050") PITCH

VERTICAL

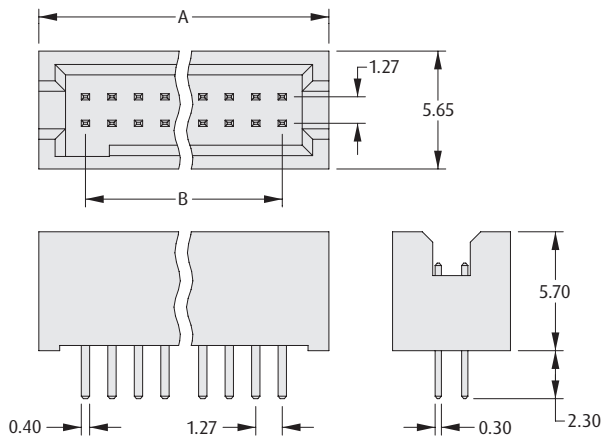

HORIZONTAL

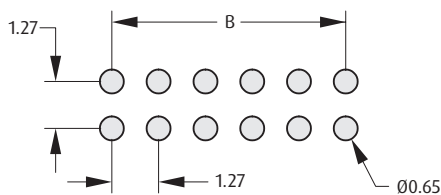
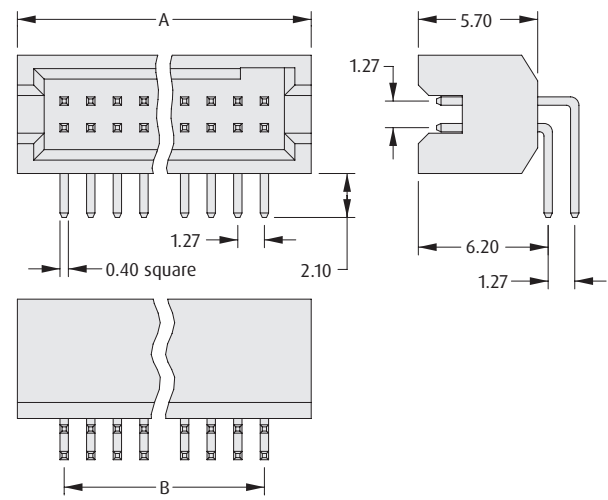

Recommended PC Board Pattern

CALCULATION

A	$B + 4.47$
B	$1.27 \times (\text{No. of contacts per row} - 1)$

HOW TO ORDER

M50 - 4 X 0 XX 45

SERIES CODE

TYPE

7	Vertical
8	Horizontal

FINISH

45 Gold

NO. OF CONTACTS PER ROW

03 to 15, 20, 25

All dimensions in mm.

Archer Connectors – M50 IDC Specification

❖ 1.27mm pitch cable-to-board connectors, with latching and polarisation.

❖ Materials

Mouldings	
PC Tail, SMT:	LCP, UL94V-0
IDC Cable Connectors:	PBT, UL94V-0
Contacts:	Copper Alloy
Finish	
M50-380:	Gold on contact area
Others:	Gold on contact area, Tin on tails

❖ Electrical

Current	
M50-330, 91X:	1A per contact
M50-355, 365:	1.75A per contact
M50-380, 90X:	0.5A per contact
Voltage proof	
M50-90X/91X:	300V DC for 1 minute
Others:	1,000V AC for 1 minute
Contact resistance:	30mΩ max
Insulation resistance	
M50-90X, 91X:	5MΩ min
Others:	1,000MΩ min

❖ Mechanical

Durability:	100 operations
Insertion force (max):	1.0N per contact
Withdrawal force (min):	0.15N per contact

❖ Environmental

Operating temperature	
PC Tail, SMT:	-55°C to +125°C
IDC Cable Connectors:	-40°C to +105°C
Cable Assembly:	-20°C to +105°C
Solderability:	245°C for 5 seconds
Soldering heat resistance:	260°C for 10 seconds

1.27mm (.050") PITCH

Mating Profiles

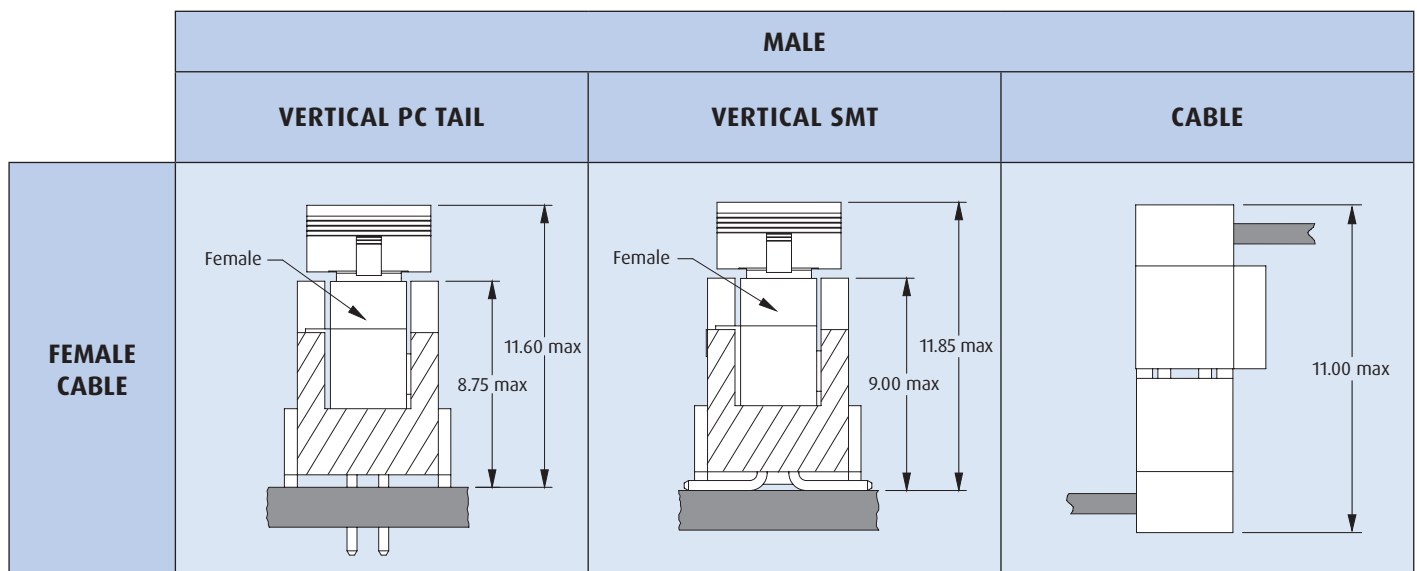

All dimensions in mm.

Archer Connectors – M50 IDC

Female Cable Connector & Cable Assembly

- ❖ Suitable for use with male vertical latching connectors shown on the following page.
- ❖ IDC connection for fast termination of multiple contacts.
- ❖ Polarised to prevent mis-mating.
- ❖ Secure cable retention with positive latching to header.
- ❖ Standard cable assembly lengths from stock.
- ❖ Instruction sheet for Hand Tool is available at www.harwin.com/instructions.

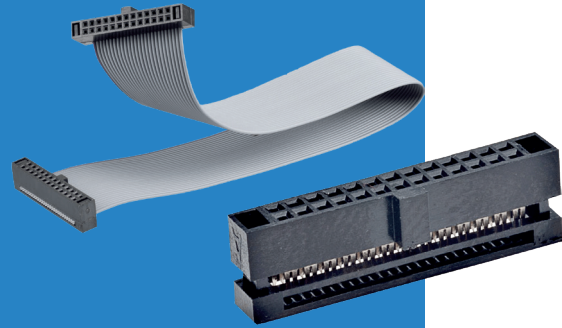

1.27mm (.050") PITCH

FEMALE IDC

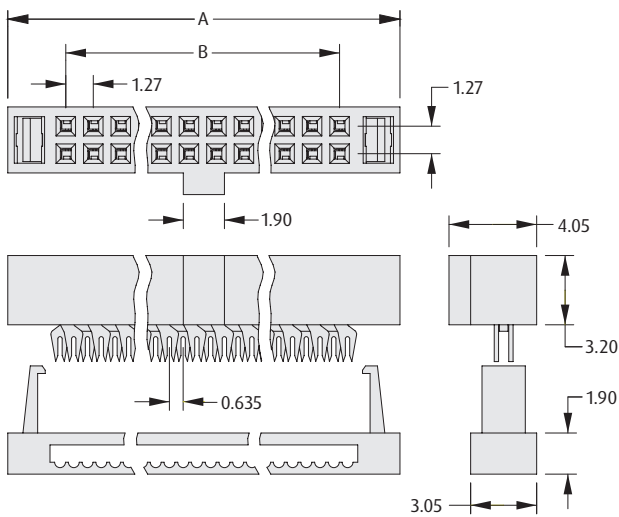

FEMALE-TO-FEMALE CABLE

- ❖ Uses 0.635mm pitch 30 AWG Ribbon cable to UL2678.
- ❖ Constructed with Contact 1 attached to Contact 1, Contact 2 to Contact 2, etc.

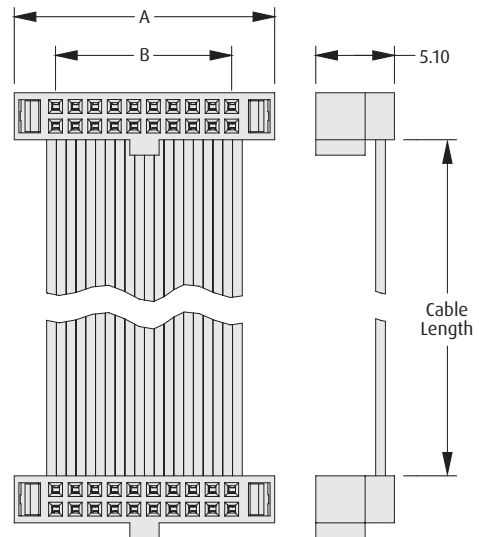

HAND TOOL



ORDER CODE
Z50-020

CALCULATION

A	$B + 5.47$
B	$1.27 \times (\text{No. of contacts per row} - 1)$

HOW TO ORDER

M50 - XXX XX 42

SERIES CODE

FINISH

42 Gold + Tin

TYPE

330	Female IDC Connector
910	150mm Cable Assembly
911	300mm Cable Assembly

NO. OF CONTACTS PER ROW

05, 10, 13, 17, 20, 25	All
06, 07, 08	M50-330 only

All dimensions in mm.

Archer Connectors – M50 IDC

Male Vertical Latching Connectors

- Suitable for use with female cable connectors shown on previous page.
- Surface mount option has locking pegs for location and retention.
- Shrouded for robust pin protection.
- Polarised to prevent mis-mating.
- Secure, positive latch & ejection system.
- Tape and Reel packaging option includes Pick and Place cap for automated assembly.

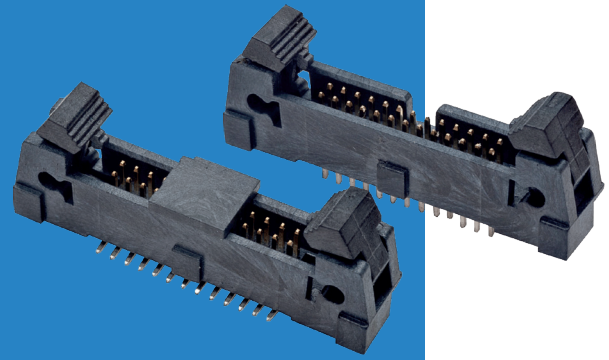

1.27mm (.050") PITCH

PC TAIL

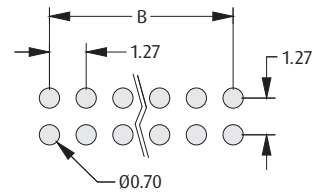
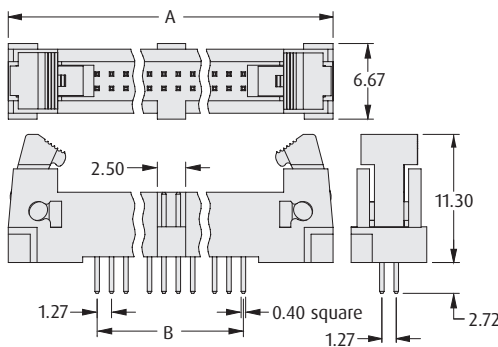

Recommended PC Board Pattern

CALCULATION

A	$B + 15.75$
B	$1.27 \times (\text{No. of contacts per row} - 1)$
C	$B + 8.64$

SURFACE MOUNT

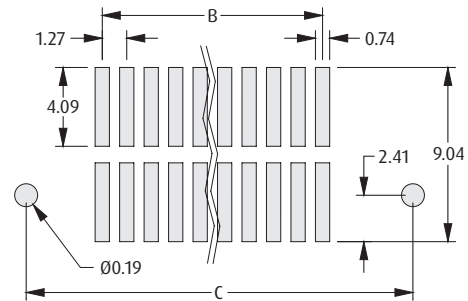
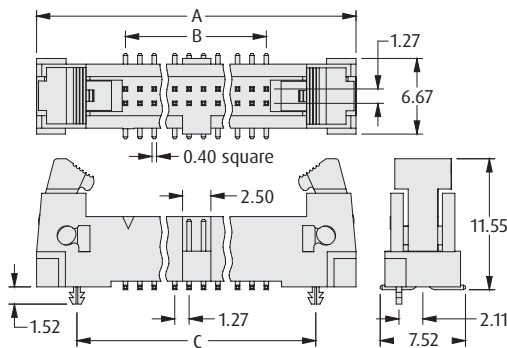

Recommended PC Board Pattern

HOW TO ORDER

M50 - 3 X 5 XX 42 X

SERIES CODE

TYPE

5	PC Tail
6	Surface Mount

NO. OF CONTACTS PER ROW

05, 06, 07, 08, 10, 13, 17, 20, 25

PACKAGING

R	Tape & Reeled (M50-365)
Blank	Loose (M50-355)

FINISH

42 Gold + Tin

All dimensions in mm.

Archer Connectors – M50 IDC

Male Cable Connectors & Cable Assembly

- Male transitional cable connector suitable for soldering directly to PCB, permits cost effective cable to PCB attachment.
- IDC connection for fast termination of multiple contacts.
- Suitable for mating with other sockets from the Archer range.
- Low profile, small footprint.
- Instruction sheet for Hand Tool is available at www.harwin.com/instructions.

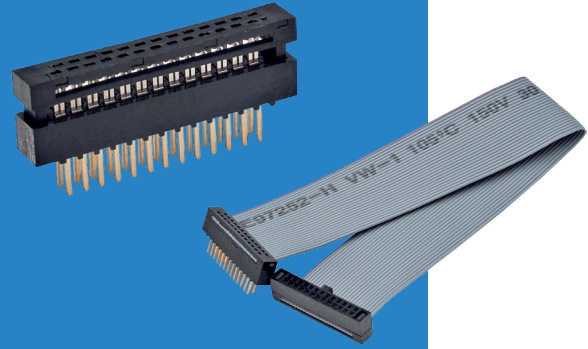

1.27mm (.050") PITCH

MALE IDC

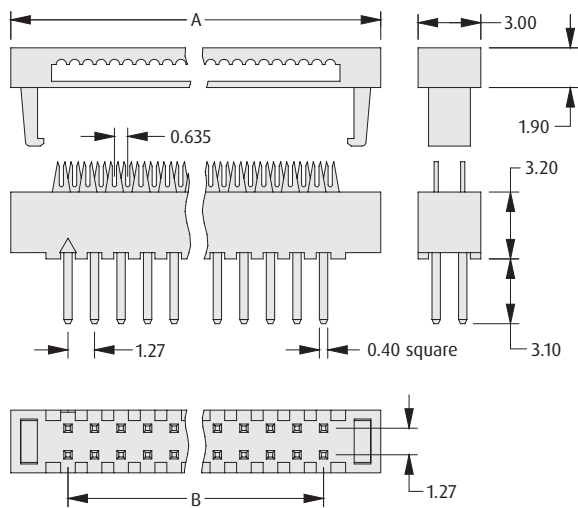

MALE-TO-FEMALE CABLE

- Uses 0.635mm pitch 30 AWG Ribbon cable to UL2678.
- Constructed with Contact 1 attached to Contact 1, Contact 2 to Contact 2, etc.

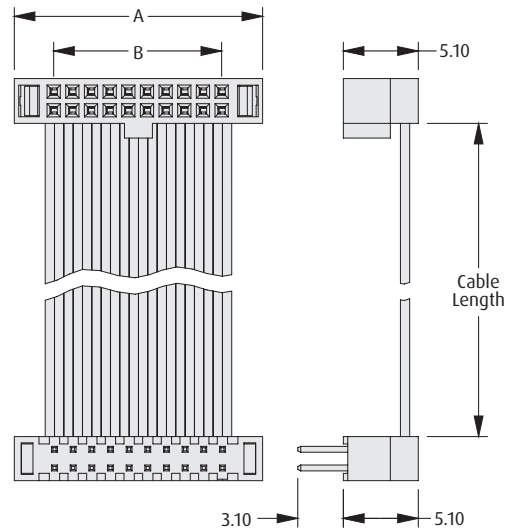

HAND TOOL



ORDER CODE
Z50-030

CALCULATION

A	$B + 5.47$
B	$1.27 \times (\text{No. of contacts per row} - 1)$

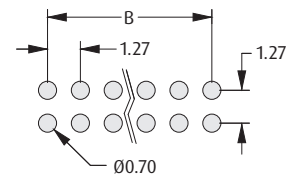

Recommended PC Board Pattern

HOW TO ORDER

M50 - XXX XX 42

SERIES CODE

TYPE

380	Male IDC Connector
901	150mm Cable Assembly
902	300mm Cable Assembly

FINISH

42	Gold + Tin
-----------	------------

NO. OF CONTACTS PER ROW

05, 10, 13, 17, 20, 25	All
06, 07, 08	M50-380 only

All dimensions in mm.

Archer Connectors – M52 Specification

➤ 1.27mm x 2.54mm pitch male pin headers (with 0.46mm square pins) and female sockets, for vertical board-to-board connection.

➤ Materials

Mouldings:	High Temperature Plastic UL94V-0
Contacts:	Copper Alloy
Finish:	Gold

➤ Electrical

Current:	1A per contact
Voltage proof:	500V AC, 1,000V DC for 1 minute
Contact resistance:	30mΩ max
Insulation resistance	1,000MΩ min

➤ Mechanical

Durability:	300 operations
Insertion force (max)	
M52-500, 510:	1.0N per contact
Others:	1.5N per contact
Withdrawal force (min)	
M52-500, 510:	0.12N per contact
Others:	0.1N per contact
Vibration sensitivity:	50-2,000Hz, 3.13G, 45 minutes duration
Shock severity:	294m/s ² (30G) for 11ms

➤ Environmental

Operating temperature:	-40°C to +105°C
Solderability:	245°C for 5 seconds
Soldering heat resistance:	260°C for 5 seconds

1.27mm (.050") PITCH

Mating Profiles

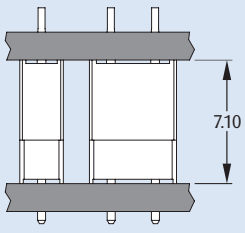
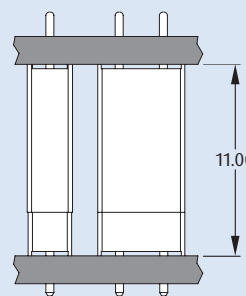
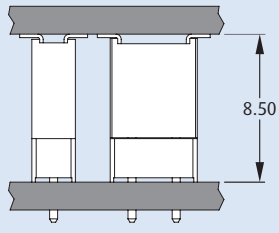
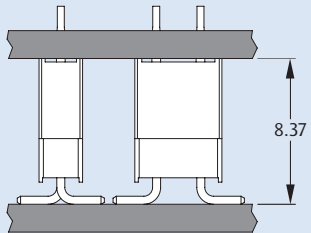
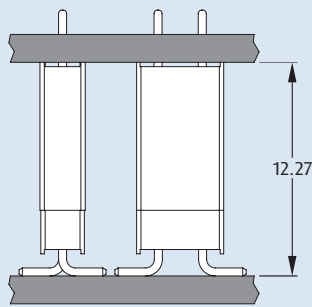
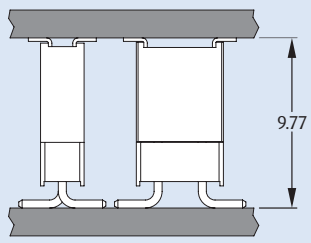
		FEMALE		
		VERTICAL PC TAIL (4.6mm Height)	VERTICAL PC TAIL (8.5mm Height)	VERTICAL SMT
MALE	VERTICAL PC TAIL			
	VERTICAL SMT			

All dimensions in mm.

Archer Connectors – M52

Female Vertical PC Tail

- Choice of connector height.
- Suitable for use with male connectors with 0.46mm square pins.

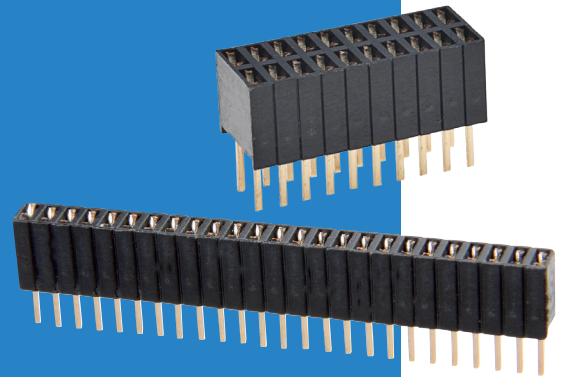

1.27mm (.050") PITCH

SINGLE ROW

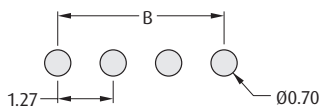
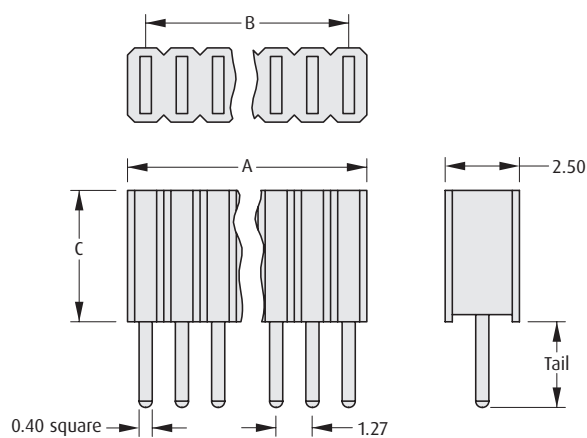

Recommended PC Board Pattern

DOUBLE ROW

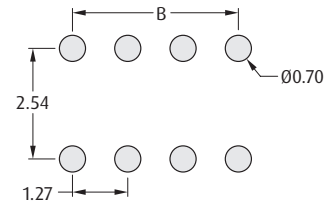
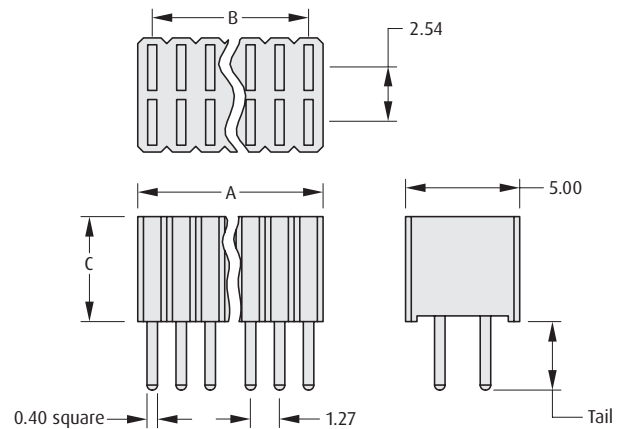

Recommended PC Board Pattern

CALCULATION

A	B + 1.67 (when C = 4.6mm) B + 1.27 (when C = 8.5mm)
B	1.27 x (No. of contacts per row - 1)

HOW TO ORDER

M52 - 5 X X XX 45

SERIES CODE

NO. OF ROWS

0	Single Row
1	Double Row

HEIGHT

0	C = 4.6mm, Tail = 3.00mm
1	C = 8.5mm, Tail = 2.80mm

FINISH

45 Gold

NO. OF CONTACTS PER ROW

03 to 10, 12, 14 to 16, 20, 25, 40	Single, 4.6mm
03 to 10, 12, 15, 20, 23, 25	Single, 8.5mm
03 to 10, 12, 15, 20, 25, 30, 40	Double 4.6mm
03 to 10, 12, 15, 20, 23, 25	Double, 8.5mm

All dimensions in mm.

Archer Connectors – M52

Female Vertical Surface Mount

- Suitable for use with male pin headers with 0.46mm square pins.
- Twin beam contact for cost-effective reliability.
- Contact technical@harwin.com for Tape and Reel options.

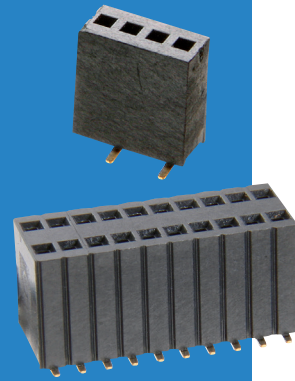

1.27mm (.050") PITCH

SINGLE ROW	DOUBLE ROW						
<p>Recommended PC Board Pattern</p>	<p>Recommended PC Board Pattern</p>						
<table border="1" style="width: 100%;"> <thead> <tr> <th colspan="2" style="background-color: #0056b3; color: white;">CALCULATION</th> </tr> </thead> <tbody> <tr> <td style="background-color: #0056b3; color: white;">A</td> <td>1.27 x No. of contacts per row</td> </tr> <tr> <td style="background-color: #0056b3; color: white;">B</td> <td>1.27 x (No. of contacts per row - 1)</td> </tr> </tbody> </table>		CALCULATION		A	1.27 x No. of contacts per row	B	1.27 x (No. of contacts per row - 1)
CALCULATION							
A	1.27 x No. of contacts per row						
B	1.27 x (No. of contacts per row - 1)						

HOW TO ORDER

M52 - 5 X 5 XX 45

SERIES CODE		FINISH	45 Gold
TYPE		NO. OF CONTACTS PER ROW	03 to 10, 12, 15, 20, 25
0 Single Row			
1 Double Row			

All dimensions in mm.

Archer Connectors – M52

Male Vertical PC Tail

- ❖ Suitable for use with female connectors shown on previous page.
- ❖ For alternative pin lengths, see pin header variants on following pages.

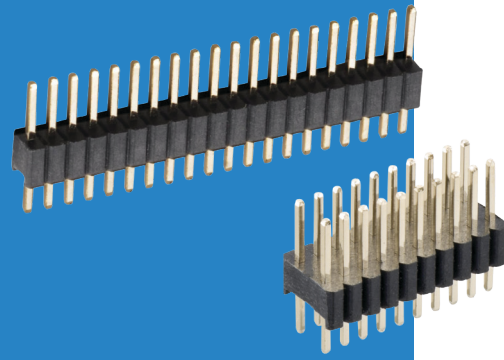

1.27mm (.050") PITCH

SINGLE ROW

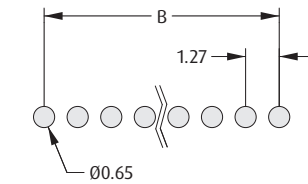
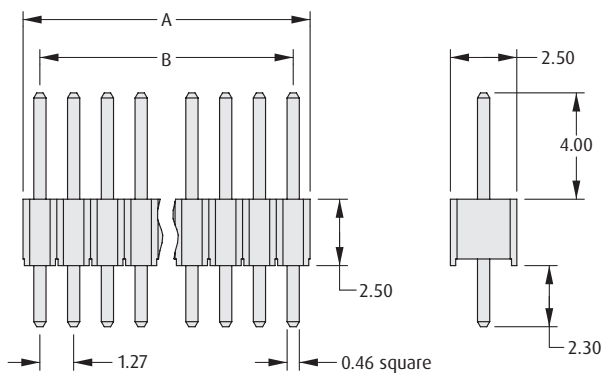

Recommended PC Board Pattern

CALCULATION

A	1.27 x No. of contacts per row
B	1.27 x (No. of contacts per row - 1)

DOUBLE ROW

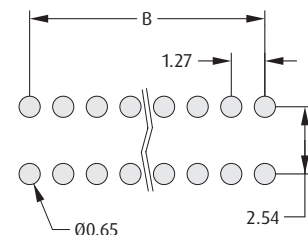
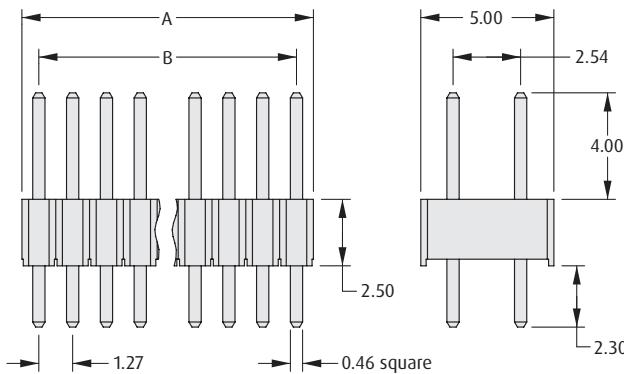

Recommended PC Board Pattern

HOW TO ORDER

M52 - 040023 X XX 45

SERIES CODE

TYPE

V	Single Row
W	Double Row

FINISH

45 Gold

NO. OF CONTACTS PER ROW

05, 10, 20, 25

All dimensions in mm.

Archer Connectors – M52

Male Vertical Surface Mount

- Suitable for use with female connectors shown on previous page.
- For alternative pin lengths, see pin header variants on following pages.
- Contact technical@harwin.com for Tape and Reel options.

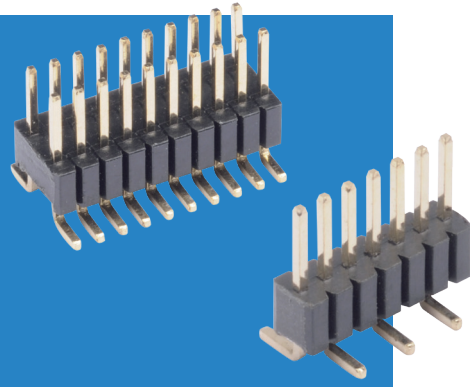

1.27mm (.050") PITCH

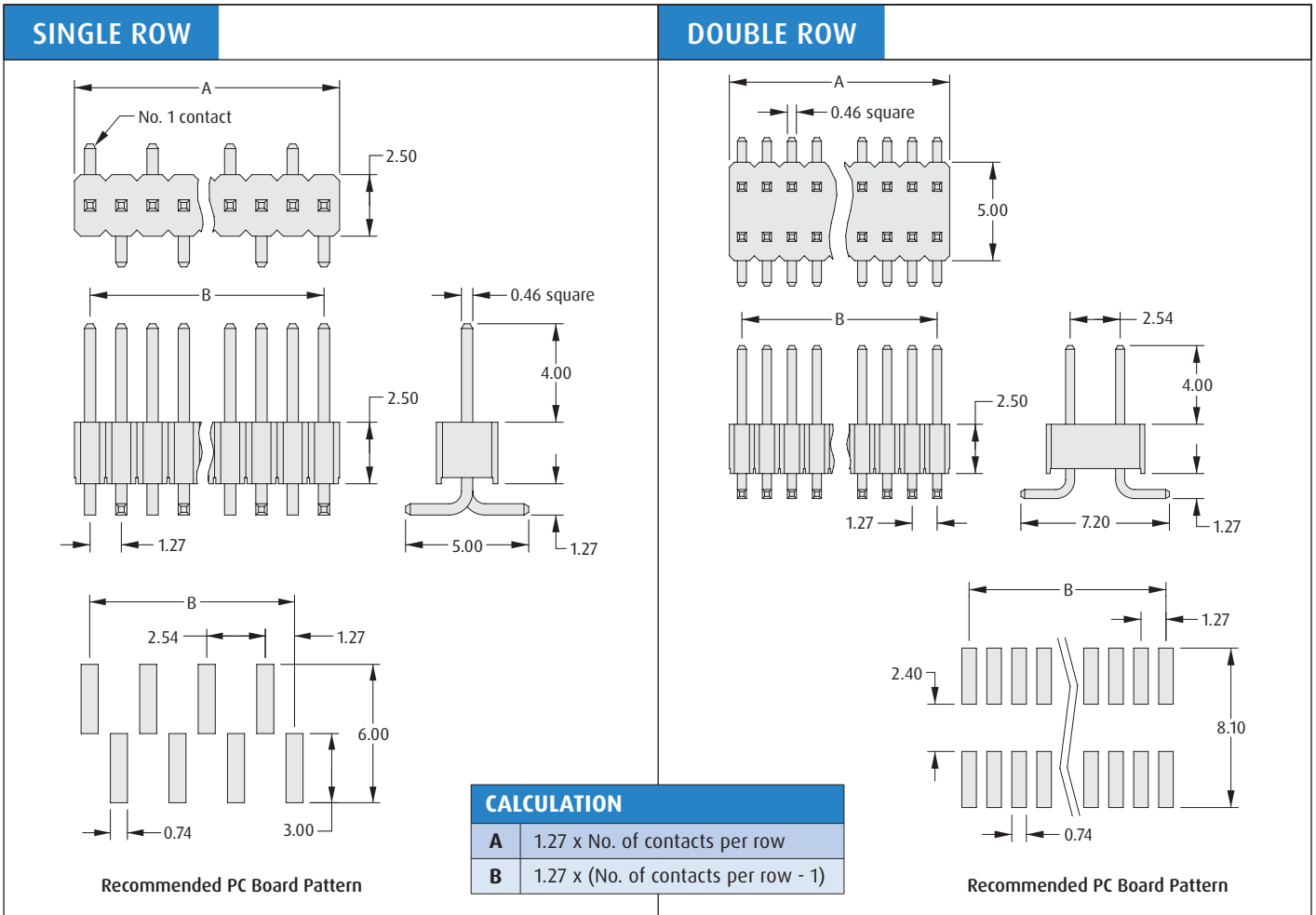

HOW TO ORDER

M52 - 040000 X XX 45

SERIES CODE		FINISH	45 Gold
TYPE		NO. OF CONTACTS PER ROW	
P Single Row		05, 10, 20, 25	
S Double Row			

All dimensions in mm.

Archer Connectors – M52

Pin Header Variants

- ❖ If you are unable to specify the connector you require from our standard range of Archer M52 connectors, use the order code below to create an application-specific connector.
- ❖ Contact technical@harwin.com for further information, or search online for M52-XXX.
- ❖ Suitable for use with female connectors shown on previous pages.

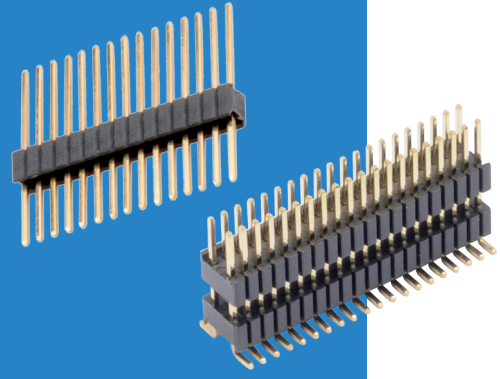

1.27mm (.050") PITCH

TERMINATION STYLES

Vertical PC Tail

- ❖ Pin section is 0.46mm square.
- ❖ PCB mounting hole is $\varnothing 0.65\text{mm}$.

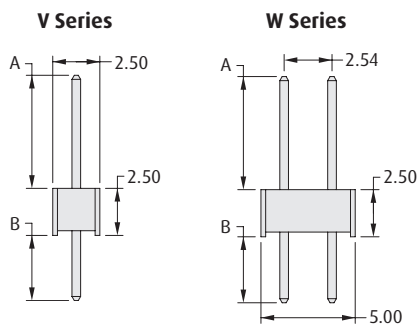

Extended PC Tail

- ❖ Pin section is 0.46mm square.
- ❖ PCB mounting hole is $\varnothing 0.65\text{mm}$.

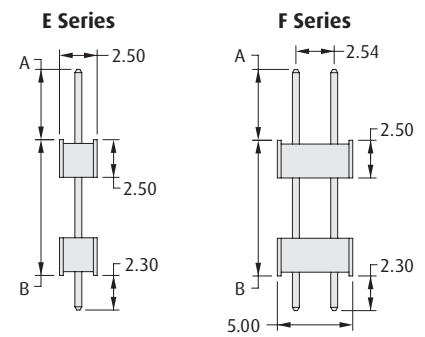

Vertical SMT

- ❖ Pin section is 0.46mm square.
- ❖ For PCB pad layout see standard Male SMT pin header.
- ❖ B dimension is 000.

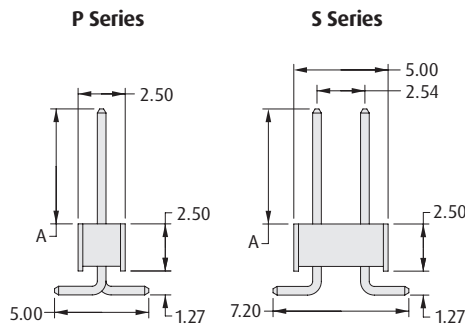

Extended SMT

- ❖ Pin section is 0.46mm square.
- ❖ For PCB pad layout see standard Male SMT pin header.

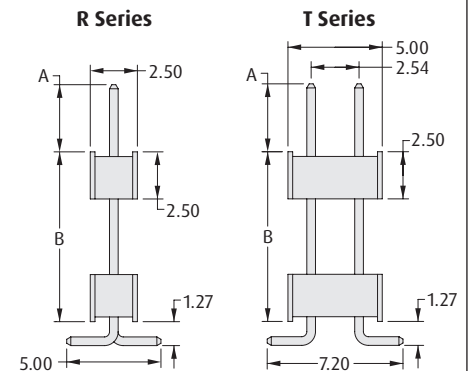

HOW TO ORDER

M52 - XXX XXX X XX 45

SERIES CODE

DIMENSION A

Example: 7.8mm = 078

DIMENSION B

Example: 5.0mm = 050

FINISH

45 Gold

NO. OF CONTACTS PER ROW

02 to 50

SINGLE ROW	DOUBLE ROW	
V	W	Vertical
E	F	Extended
P	S	SMT
R	T	Extended SMT

All dimensions in mm.