

ZM Series Subminiature Snap-acting Switches

Features/Benefits

- **Reliable snap-acting mechanism**
- **Long electrical and mechanical life**
- **Compact size—Ideal when space is limited**
- **Various PCB terminals and actuators**
- **RoHS compliant / compatible**

Typical Applications

- **PCB detection switch**
- **Communication devices**
- **Testing equipment**
- **Security/Alarm systems**
- **Consumer electronics**

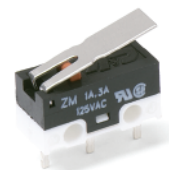

UL61058-1



Specifications

CONTACT RATING: F7: 3A @ 125 VAC
M9: 0.2A @ 60 VDC.

ELECTRICAL LIFE: 10,000 Cycles. @ 3A

INSULATION RESISTANCE: 100 M ohm min.

DIELECTRIC STRENGTH: 1000 Vrms.

OPERATING TEMPERATURE: -30°C to 85°C.

OPERATING FORCE: CJ: 150 grams, CH: 90 grams.

* Low Level=conditions where no arcing occurs during switching, i.e., 0.4 VA max. @ 20 V AC or DC max.

Materials

COVER: Nylon 6/6

ACTUATOR BUTTON: Nylon 6/6

CASE: Nylon 6/6

SPRING: SUS

MOVABLE BLADE: BeCu

MOVABLE CONTACT: Silver alloy (M9 option gold plated)

FIXED CONTACTS: Silver alloy (M9 option gold plated)

FIXED TERMINALS: Brass - Ag plated.

ACTUATOR (Leaf / Roller options): SUS

NOTE: Specifications and materials listed above are for switches with standard options. For information on specific and custom switches, consult Customer Service Center.

Build-A-Switch

To order, simply select desired option from each category and place in the appropriate box. Available options are shown and described on pages J-48 and J-49. For additional options not shown in catalog, consult Customer Service Center.

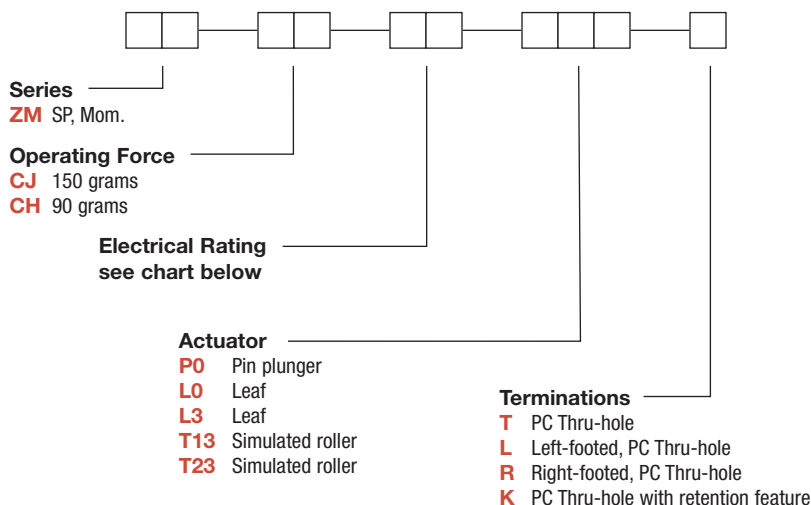

Option Code	UL cUL US 1054	UL cUL US 61058-1	RoHS
F7	3 A 125 V AC	3 A 125 V AC 3 A 30 V DC	3 A 125 V AC
M9	0.1 A 48 V DC 0.2 A 60 V DC 0.1 A 125 V AC	0.1 A 48 V DC 0.2 A 60 V DC 0.1 A 125 V AC	0.1 A 48 V DC 0.2 A 60 V DC 0.1 A 125 V AC



Dimensions are shown: Inches (mm)
Specifications and dimensions subject to change



Snap-acting

ZM Series Subminiature Snap-acting Switches

SERIES **ZM** ■ ■ ■ ■ ■ ■ ■ ■

ZM SUBMINIATURE SNAP-ACTING SWITCHES – SP MOMENTARY

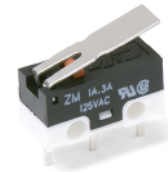
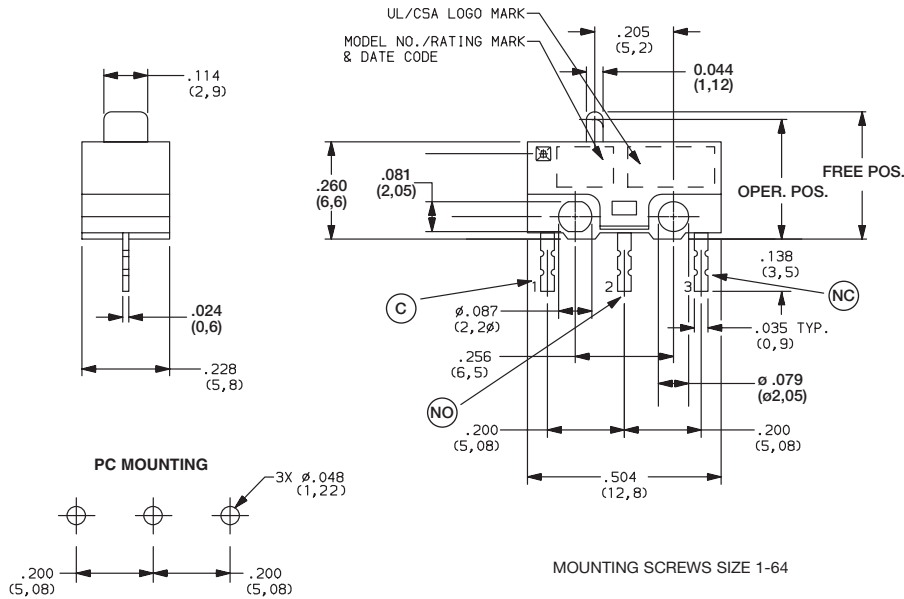

ZMCJF7L0T
SPDT

OPERATING FORCE ■ ■ ■ ■ ■ ■ ■ ■

OPTION CODE	BASIC SWITCH OPERATING FORCE (OZ./GRAMS)
CJ	5.29 150
CH	3.15 90

ELECTRICAL RATING ■ ■ ■ ■ ■ ■ ■ ■

OPTION CODE	RoHS COMPLIANT*	RoHS COMPATIBLE*	CONTACT MATERIAL		ELECTRICAL RATING
			MOVABLE CONTACT	STATIONARY CONTACT	
F7	Yes	Yes	Silver alloy		see chart
M9	Yes	Yes	Gold plating or silver alloy		see chart

* Note: See Technical Data section of this catalog for RoHS compliant and compatible definition and specifications.

All models **cULus** with all options.

Consult Customer Service center for availability and delivery of nonstandard ratings.

Option Code	cULus 1054	cULus 61058-1	
F7	3 A 125 V AC	3 A 125 V AC 3 A 30 V DC	3 A 125 V AC
M9	0.1 A 48 V DC 0.2 A 60 V DC 0.1 A 125 V AC	0.1 A 48 V DC 0.2 A 60 V DC 0.1 A 125 V AC	0.1 A 48 V DC 0.2 A 60 V DC 0.1 A 125 V AC

Snap-acting

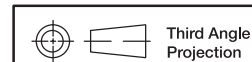

Dimensions are shown: Inch (mm)
Specifications and dimensions subject to change

ZM Series Subminiature Snap-acting Switches

ACTUATOR

P0 PIN PLUNGER

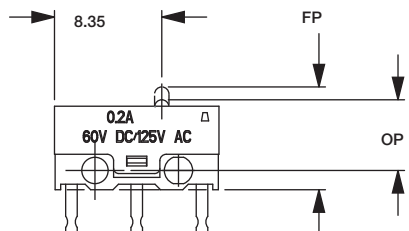

L0 LEAF, 50 GRAMS (CJ ONLY)
L3 LEAF, 30 GRAMS (CH ONLY)

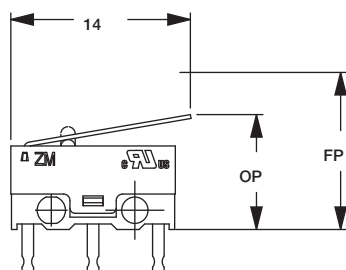

T13 SIMULATED ROLLER, 40 GRAMS (CJ ONLY)
T23 SIMULATED ROLLER, 25 GRAMS (CH ONLY)

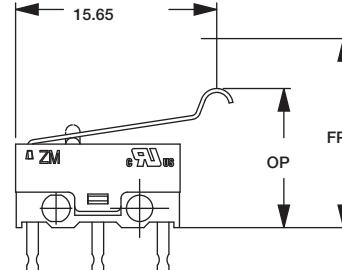

ACTUATOR OPTION CODE	A (mm)	B Ref (mm)	C (mm)	D (mm)	E (mm)	DIFF. MOTION mm MAX	OPER. FORCE grams MAX		RELEASED FORCE Grams MAX	OVER TRAVEL MIN
	LENGTH OF LEVER	LEVER LENGTH MTG. HOLE TO OP	PRE- TRAVEL MAX	OPERATING POSITION	FREE POSITION MAX		CJ	CH		
P0 PIN PLUNGER	NA	NA	1.3	7.0 ±0.3	8.0	0.3	150	90	15-20	0.2
L0 LEAF	13.0	4.03	3.4	8.4 ±0.8	11.0	1.3	50	-	8	0.6
L3 LEAF	13.0	4.03	3.4	8.4 ±0.8	11.0	1.3	-	30	5	0.6
T13 SIMULATED ROLLER	15.0	5.36	3.8	10.5 ±0.8	13.0	1.5	40	-	7	0.6
T23 SIMULATED ROLLER	15.0	5.36	3.8	10.5 ±0.8	13.0	1.5	-	25	4	0.6



Snap-acting

TERMINATIONS

T (STD.) PC THRU-HOLE

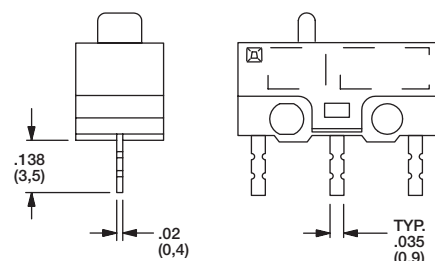

K PC THRU-HOLE WITH RETENTION FEATURE

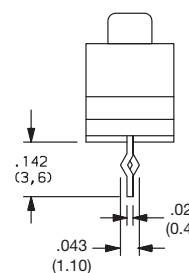

L LEFT FOOTED, PC THRU-HOLE

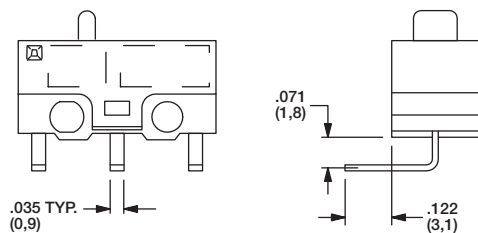

R RIGHT FOOTED, PC THRU-HOLE

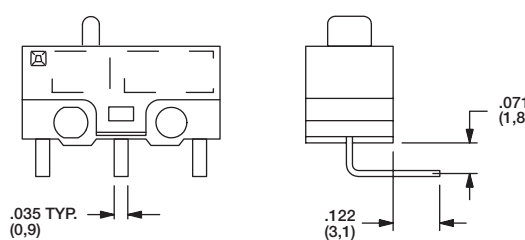

Third Angle
Projection

Dimensions are shown: Inches (mm)
Specifications and dimensions subject to change

C&K