

High Power LED Series  
3535 Ceramic Hot Binning

# LH351B

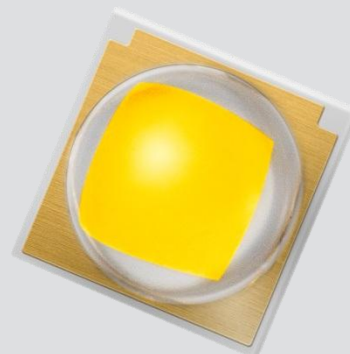

High efficacy and high quality color rendering makes the LH351B suitable use in a broad range of applications

#### Features & Benefits

- Operates at a maximum current of up to 1.5 A
- Uniform light distribution under any beam angle
- 80 CRI makes it well suited for most applications
- Hot binning @ 85 °C
- Completed 10,000 hours of LM-80 testing @ 1 A, 105°C

#### Applications

- Indoor Lighting: Spotlight, Downlight
- Outdoor Lighting: Street Light, Tunnel Light, Security Light, Parking Lot Light
- Industrial Lighting: High Bay Light, Low Bay Light
- Consumer Lighting: Torch Light



## Table of Contents

|     |                                     |       |    |
|-----|-------------------------------------|-------|----|
| 1.  | Characteristics                     | ----- | 3  |
| 2.  | Product Code Information            | ----- | 7  |
| 3.  | Typical Characteristics Graphs      | ----- | 20 |
| 4.  | Outline Drawing & Dimension         | ----- | 22 |
| 5.  | Reliability Test Items & Conditions | ----- | 23 |
| 6.  | Soldering Conditions                | ----- | 24 |
| 7.  | Tape & Reel                         | ----- | 25 |
| 8.  | Label Structure                     | ----- | 27 |
| 9.  | Packing Structure                   | ----- | 28 |
| 10. | Precautions in Handling & Use       | ----- | 30 |

## 1. Characteristics

### a) Absolute Maximum Rating

| Item                         | Symbol    | Rating     | Unit    | Condition                  |
|------------------------------|-----------|------------|---------|----------------------------|
| Operating Temperature        | $T_{opr}$ | -40 ~ +105 | °C      | Note 1)*                   |
| Storage Temperature          | $T_{stg}$ | -40 ~ +120 | °C      | -                          |
| LED Junction Temperature     | $T_j$     | 150        | °C      | -                          |
| Forward Current              | $I_F$     | 1500       | mA      | -                          |
| Peak Pulse Forward Current   | $I_{FP}$  | 2000       | mA      | Duty 1/10 pulse width 10ms |
| Assembly Process Temperature |           | 260<br><10 | °C<br>s | -                          |
| ESD (HBM)                    | -         | ±8         | kV      | -                          |

#### Notes:

- 1) Refer to the derating curve, '3. Typical Characteristics Graph', for proper driving current that maintained below maximum junction temperature.

## b) Electro-optical Characteristics

| Item   | Unit | Nominal CCT<br>(K) | Condition           |                     | Value<br>Typ. |
|--|------|--------------------|---------------------|---------------------|---------------|
|  |      |                    | I <sub>F</sub> (mA) | T <sub>J</sub> (°C) |               |
| Luminous Flux (Φ <sub>v</sub> )                  | lm   | 3000<br>(80 CRI)   | 350                 | 25                  | 149           |
|  |      |                    | 350                 | 85                  | 136           |
|  |      |                    | 700                 | 85                  | 249           |
|  |      |                    | 1000                | 85                  | 332           |
|  |      |                    | 1500                | 85                  | 446           |
|  |      | 5000<br>(70 CRI)   | 350                 | 25                  | 175           |
|  |      |                    | 350                 | 85                  | 160           |
|  |      |                    | 700                 | 85                  | 292           |
|  |      |                    | 1000                | 85                  | 391           |
|  |      |                    | 1500                | 85                  | 525           |
| Forward Voltage (V <sub>F</sub> )                | V    |                    | 350                 | 25                  | 2.86          |
|  |      |                    | 350                 | 85                  | 2.75          |
|  |      |                    | 700                 | 85                  | 2.89          |
|  |      |                    | 1000                | 85                  | 2.99          |
|  |      |                    | 1500                | 85                  | 3.12          |
| Reverse Voltage<br>(@ 5 mA)                      | V    |                    | 350                 | 25                  | 14~19.5       |
| Thermal Resistance<br>(junction to solder point) | °C/W |                    | 350                 | 25                  | 4             |
| Beam Angle                                       | °    |                    | 350                 | 25                  | 120           |

**Notes:**

- 1) Samsung maintains measurement tolerance of: luminous flux = ±7 %, forward voltage = ±0.1 V
- 2) Characteristics @ 25 °C are for reference only

c) Luminous Flux Characteristics (T<sub>j</sub> = 85 °C)

| Nominal CCT (K) | CRI (R <sub>a</sub> ) Min. <sup>1)</sup> | Sorting @ 350 mA (lm) |                         | Calculated Minimum Flux <sup>2)</sup> (lm) |           |           |
|-----------------|--|-----------------------|-------------------------|--|-----------|-----------|
|                 |  | Flux Rank             | Flux Min. <sup>1)</sup> | @ 700 mA                                   | @ 1000 mA | @ 1500 mA |
| 2200            | 80                                       | G3                    | 100                     | 181  | 238       | 322       |
|                 |  | (H3)                  | (110)                   | (199)                                      | (262)     | (353)     |
|                 | 70                                       | K3                    | 130                     | 235  | 310       | 418       |
|                 |  | (M3)                  | (143)                   | (258)                                      | (340)     | (460)     |
| 2700            | 70                                       | M3                    | 140                     | 252  | 335       | 457       |
|                 |  | (N3)                  | (153)                   | (276)                                      | (366)     | (499)     |
|                 |  | N3                    | 150                     | 270  | 359       | 489       |
|                 |  | (P3)                  | (164)                   | (295)                                      | (392)     | (534)     |
|                 | 80                                       | J3                    | 120                     | 217  | 286       | 386       |
|                 |  | (K3)                  | (132)                   | (238)                                      | (314)     | (424)     |
|                 |  | K3                    | 130                     | 235  | 310       | 418       |
|                 |  | (M3)                  | (143)                   | (258)                                      | (340)     | (460)     |
|                 | 90                                       | F3                    | 90                      | 163  | 214       | 289       |
|                 |  | (G3)                  | (99)                    | (179)                                      | (236)     | (318)     |
|                 |  | G3                    | 100                     | 181  | 238       | 322       |
|                 |  | (H3)                  | (110)                   | (199)                                      | (262)     | (353)     |
| 3000            | 70                                       | M3                    | 140                     | 252  | 335       | 457       |
|                 |  | (N3)                  | (153)                   | (276)                                      | (366)     | (499)     |
|                 |  | N3                    | 150                     | 270  | 359       | 489       |
|                 |  | (P3)                  | (164)                   | (295)                                      | (392)     | (534)     |
|                 | 80                                       | J3                    | 120                     | 217  | 286       | 386       |
|                 |  | (K3)                  | (132)                   | (238)                                      | (314)     | (424)     |
|                 |  | K3                    | 130                     | 234  | 311       | 424       |
|                 |  | (M3)                  | (142)                   | (256)                                      | (340)     | (463)     |
|                 | 90                                       | M3                    | 140                     | 252  | 335       | 457       |
|                 |  | (N3)                  | (153)                   | (276)                                      | (366)     | (499)     |
|                 |  | G3                    | 100                     | 181  | 238       | 322       |
|                 |  | (H3)                  | (110)                   | (199)                                      | (262)     | (353)     |
| 3500            | 70                                       | H3                    | 110                     | 199  | 262       | 354       |
|                 |  | (J3)                  | (121)                   | (218)                                      | (288)     | (389)     |
|                 |  | K3                    | 130                     | 234  | 311       | 424       |
|                 |  | (M3)                  | (142)                   | (256)                                      | (340)     | (463)     |
|                 | 80                                       | M3                    | 140                     | 252  | 335       | 457       |
|                 |  | (N3)                  | (153)                   | (276)                                      | (366)     | (499)     |
|                 |  | N3                    | 150                     | 270  | 359       | 489       |
|                 |  | (P3)                  | (164)                   | (295)                                      | (392)     | (534)     |
|                 | 90                                       | K3                    | 130                     | 234  | 311       | 424       |
|                 |  | (M3)                  | (142)                   | (256)                                      | (340)     | (463)     |
|                 |  | G3                    | 100                     | 181  | 238       | 322       |
|                 |  | (H3)                  | (110)                   | (199)                                      | (262)     | (353)     |
| 90              | H3                                       | 110                   | 199                     | 262  | 354       |           |
|                 | (J3)                                     | (121)                 | (218)                   | (288)                                      | (389)     |           |

(value in bracket): Minimum luminous flux @ 25 °C, for reference only

**Notes:**

- 1) Samsung maintains measurement tolerance of: luminous flux = ±7 %, CRI = ±3
- 2) Calculated minimum flux values are for reference only

c) Luminous Flux Characteristics (T<sub>j</sub> = 85 °C)

| Nominal CCT<br>(K) | CRI (R <sub>a</sub> )<br>Min. <sup>1)</sup> | Sorting @ 350 mA (lm) |                         | Calculated Minimum Flux <sup>2)</sup> (lm) |              |              |
|--------------------|---|-----------------------|-------------------------|--|--------------|--------------|
|                    |   | Flux Rank             | Flux Min. <sup>1)</sup> | @ 700 mA                                   | @ 1000 mA    | @ 1500 mA    |
| 4000               | 70  | N3<br>(P3)            | 150<br>(164)            | 270<br>(295)                               | 359<br>(392) | 489<br>(534) |
|                    |   | P3<br>(Q3)            | 160<br>(174)            | 288<br>(312)                               | 382<br>(415) | 518<br>(562) |
|                    |   | K3<br>(M3)            | 130<br>(143)            | 235<br>(258)                               | 310<br>(340) | 418<br>(460) |
|                    | 80  | M3<br>(N3)            | 140<br>(153)            | 252<br>(276)                               | 335<br>(366) | 457<br>(499) |
|                    |   | J3<br>(K3)            | 120<br>(132)            | 217<br>(238)                               | 286<br>(314) | 386<br>(424) |
|                    |   | M3<br>(N3)            | 140<br>(153)            | 252<br>(276)                               | 335<br>(366) | 457<br>(499) |
| 5000               | 70  | N3<br>(P3)            | 150<br>(164)            | 270<br>(295)                               | 359<br>(392) | 489<br>(534) |
|                    |   | P3<br>(Q3)            | 160<br>(174)            | 288<br>(312)                               | 382<br>(415) | 518<br>(562) |
|                    |   | Q2<br>(R2)            | 170<br>(184)            | 306<br>(329)                               | 405<br>(437) | 545<br>(590) |
|                    | 80  | M3<br>(N3)            | 140<br>(153)            | 252<br>(276)                               | 335<br>(366) | 457<br>(499) |
|                    |   | N3<br>(P3)            | 150<br>(164)            | 270<br>(295)                               | 359<br>(392) | 489<br>(534) |
|                    |   | K3<br>(M3)            | 130<br>(142)            | 234<br>(256)                               | 311<br>(340) | 424<br>(463) |
| 5700               | 70  | N3<br>(P3)            | 150<br>(164)            | 270<br>(295)                               | 359<br>(392) | 489<br>(534) |
|                    |   | P3<br>(Q3)            | 160<br>(174)            | 288<br>(312)                               | 382<br>(415) | 518<br>(562) |
|                    | 80  | M3<br>(N3)            | 140<br>(153)            | 252<br>(276)                               | 335<br>(366) | 457<br>(499) |
| 6000K              | 80  | K3<br>(M3)            | 130<br>(142)            | 234<br>(256)                               | 311<br>(340) | 424<br>(463) |
|                    |   | M3<br>(N3)            | 140<br>(153)            | 252<br>(276)                               | 335<br>(366) | 457<br>(499) |
| 6500               | 70  | N3<br>(P3)            | 150<br>(164)            | 270<br>(295)                               | 359<br>(392) | 489<br>(534) |
|                    |   | P3<br>(Q3)            | 160<br>(174)            | 288<br>(312)                               | 382<br>(415) | 518<br>(562) |
|                    | 80  | K3<br>(M3)            | 130<br>(142)            | 234<br>(256)                               | 311<br>(340) | 424<br>(463) |
|                    |   | M3<br>(N3)            | 140<br>(153)            | 252<br>(276)                               | 335<br>(366) | 457<br>(499) |

(value in bracket): Minimum luminous flux @ 25 °C, for reference only

**Notes:**

- 1) Samsung maintains measurement tolerance of: luminous flux = ±7 %, CRI = ±3
- 2) Calculated minimum flux values are for reference only

## 2. Product Code Information

|   |   |   |   |   |   |   |   |   |    |    |    |    |    |    |    |    |    |
|---|---|---|---|---|---|---|---|---|----|----|----|----|----|----|----|----|----|
| 1 | 2 | 3 | 4 | 5 | 6 | 7 | 8 | 9 | 10 | 11 | 12 | 13 | 14 | 15 | 16 | 17 | 18 |
| S | P | H | W | H | 2 | L | 3 | D | 3  | 0  | E  | D  | 4  | V  | 0  | K  | 3  |

| Digit   | PKG Information            | Code  | Specification   |
|---|----------------------------|---|---|
| 1 2 3   | Samsung Package High Power | <b>SPH</b>  |   |
| 4 5   | Color                      | <b>WH</b>   | White   |
| 6   | Product Version            | <b>2</b>  |   |
| 7 8   | Product                    | <b>L3</b>   | LH351 Series  |
| 9   | Lens Type                  | <b>D</b>  | Dome lens   |
| 10  | Internal Code              | <b>3</b>  |   |
| 11  | Not Defined                | <b>0</b>  | Default   |
| 12  | CRI & Sorting Temperature  | <b>C</b><br><b>D</b><br><b>E</b><br><b>F</b><br><b>G</b>  | Min. 70<br>Min. 75<br>Min. 80     85°C<br>Min. 85<br>Min. 90  |
| 13 14   | Forward Voltage (V)        | <b>D4</b>   | 2.6~3.0     Bin Code: <b>D2</b> 2.6~2.8<br><b>F2</b> 2.8~3.0  |
| 15 16   | CCT (K)                    | <b>Y★</b><br><b>W★</b><br><b>V★</b><br><b>U★</b><br><b>T★</b><br><b>RT</b><br><b>QT</b><br><b>PQ</b><br><b>PT</b> | 2200     Y1, Y2, Y3, Y4, Y5, Y6, Y7, Y8, Y9, YA, YB, YC, YD, YE, YF, YG, YM<br>2700     W1, W2, W3, W4, W5, W6, W7, W8, W9, WA, WB, WC, WD, WE, WF, WG, WM<br>3000     V1, V2, V3, V4, V5, V6, V7, V8, V9, VA, VB, VC, VD, VE, VF, VG, VM<br>3500     U1, U2, U3, U4, U5, U6, U7, U8, U9, UA, UB, UC, UD, UE, UF, UG, UM<br>4000     Bin Code: T1, T2, T3, T4, T5, T6, T7, T8, T9, TA, TB, TC, TD, TE, TF, TG, TM<br>5000     R1, R2, R3, R4<br>5700     Q1, Q2, Q3, Q4<br>6000     P2, Q1, P4, Q3<br>6500     P1, P2, P3, P4 |
| ★ : "0" (Whole bin), "P" (Quarter bin), or "M" (MacAdam 3-step ellipse bin)   |                            |   |   |
| 17 18   | Luminous Flux (lm)         | <b>F3</b><br><b>G3</b><br><b>H3</b><br><b>J3</b><br><b>K3</b><br><b>M3</b><br><b>N3</b><br><b>P3</b><br><b>Q2</b> | 90~120 <b>F1</b> 90~100<br>100~130 <b>G1</b> 100~110 <b>F3</b><br>110~140 <b>H1</b> 110~120 <b>G3</b><br>120~150 <b>J1</b> 120~130 <b>H3</b><br>130~160 <b>K1</b> 130~140 <b>J3</b><br>140~170 <b>M1</b> 140~150 <b>K3</b><br>150~180 <b>N1</b> 150~160 <b>M3</b><br>160~190 <b>P1</b> 160~170 <b>N3</b><br>170~190 <b>Q1</b> 170~180<br><b>R1</b> 180~190  |
| Digit 17: Min. spec.<br>Digit 18: The number of higher bin(s) from min. spec.<br>e.g.: K1 = 130~140 lm, K3 = 130~160 lm |                            |   |   |

a) Luminous Flux Bins ( $I_f = 350 \text{ mA}$ ,  $T_j = 85 \text{ }^\circ\text{C}$ )

| Nominal CCT (K) | CRI (R <sub>a</sub> ) Min. | Product Code         | Flux Rank            | Flux Bin  | Flux Range (Φ <sub>v</sub> , lm) |           |
|-----------------|----------------------------|----------------------|----------------------|-----------|----------------------------------|-----------|
| 2200            | 80                         | SPHWH2L3D30ED4Y ☆ G3 | G3                   | G1        | 100 ~ 110                        |           |
|                 |                            |                      |                      | H1        | 110 ~ 120                        |           |
|                 |                            |                      |                      | J1        | 120 ~ 130                        |           |
|                 | 70                         | 80                   | SPHWH2L3D30CD4W ☆ K3 | K3        | K1                               | 130 ~ 140 |
|                 |                            |                      |                      |           | M1                               | 140 ~ 150 |
|                 |                            | 70                   | SPHWH2L3D30CD4W ☆ M3 | M3        | N1                               | 150 ~ 160 |
|                 |                            |                      |                      |           | M1                               | 140 ~ 150 |
|                 |                            |                      |                      |           | N1                               | 150 ~ 160 |
|                 |                            |                      |                      |           | P1                               | 160 ~ 170 |
|                 |                            |                      |                      |           | N1                               | 150 ~ 160 |
| 2700            | 80                         | SPHWH2L3D30CD4W ☆ N3 | N3                   | P1        | 160 ~ 170                        |           |
|                 |                            |                      |                      | Q1        | 170 ~ 180                        |           |
|                 |                            |                      |                      | J1        | 120 ~ 130                        |           |
|                 | 90                         | 80                   | SPHWH2L3D30ED4W ☆ J3 | J3        | K1                               | 130 ~ 140 |
|                 |                            |                      |                      |           | M1                               | 140 ~ 150 |
|                 |                            |                      |                      |           | K1                               | 130 ~ 140 |
|                 |                            |                      |                      |           | M1                               | 140 ~ 150 |
|                 |                            |                      |                      |           | N1                               | 150 ~ 160 |
|                 |                            | 90                   | SPHWH2L3D30GD4W ☆ F3 | F3        | F1                               | 90 ~ 100  |
|                 |                            |                      |                      |           | G1                               | 100 ~ 110 |
| H1              |                            |                      |                      |           | 110 ~ 120                        |           |
| G1              |                            |                      |                      |           | 100 ~ 110                        |           |
| H1              |                            |                      |                      |           | 110 ~ 120                        |           |
| 3000            | 70                         | SPHWH2L3D30GD4W ☆ G3 | G3                   | J1        | 120 ~ 130                        |           |
|                 |                            |                      |                      | M1        | 140 ~ 150                        |           |
|                 |                            |                      |                      | N1        | 150 ~ 160                        |           |
|                 |                            |                      |                      | P1        | 160 ~ 170                        |           |
|                 |                            |                      |                      | N1        | 150 ~ 160                        |           |
|                 | 80                         | SPHWH2L3D30CD4V ☆ M3 | M3                   | P1        | 160 ~ 170                        |           |
|                 |                            |                      |                      | Q1        | 170 ~ 180                        |           |
|                 |                            |                      |                      | J1        | 120 ~ 130                        |           |
|                 |                            |                      |                      | K1        | 130 ~ 140                        |           |
|                 |                            |                      |                      | M1        | 140 ~ 150                        |           |
| 80              | SPHWH2L3D30ED4V ☆ K3       | K3                   | K1                   | 130 ~ 140 |                                  |           |
|                 |                            |                      | M1                   | 140 ~ 150 |                                  |           |
|                 |                            |                      | N1                   | 150 ~ 160 |                                  |           |
|                 |                            |                      | M1                   | 140 ~ 150 |                                  |           |
|                 |                            |                      | N1                   | 150 ~ 160 |                                  |           |
| 80              | SPHWH2L3D30ED4V ☆ M3       | M3                   | N1                   | 150 ~ 160 |                                  |           |
|                 |                            |                      | P1                   | 160 ~ 170 |                                  |           |

"☆" can be "0" (Whole bin), "P" (Quarter bin), or "M" (MacAdam 3-step ellipse bin) of the color binning



**a) Luminous Flux Bins ( $I_F = 350 \text{ mA}$ ,  $T_j = 85 \text{ }^\circ\text{C}$ )**

| Nominal CCT (K)    | CRI (R <sub>a</sub> ) Min. | Product Code       | Flux Rank | Flux Bin | Flux Range (Φ <sub>v</sub> , lm) |
|--------------------|----------------------------|--------------------|-----------|----------|----------------------------------|
| 3000               | 90                         | SPHWH2L3D30GD4V☆G3 | G3        | G1       | 100 ~ 110                        |
|                    |                            |                    |           | H1       | 110 ~ 120                        |
|                    |                            |                    |           | J1       | 120 ~ 130                        |
|                    |                            | SPHWH2L3D30GD4V☆H3 | H3        | H1       | 110 ~ 120                        |
|                    |                            |                    |           | J1       | 120 ~ 130                        |
|                    |                            |                    |           | K1       | 130 ~ 140                        |
| 3500               | 80                         | SPHWH2L3D30CD4U☆K3 | K3        | K1       | 130 ~ 140                        |
|                    |                            |                    |           | M1       | 140 ~ 150                        |
|                    |                            |                    |           | N1       | 150 ~ 160                        |
|                    |                            | SPHWH2L3D30CD4U☆M3 | M3        | M1       | 140 ~ 150                        |
|                    |                            |                    |           | N1       | 150 ~ 160                        |
|                    |                            |                    |           | P1       | 160 ~ 170                        |
| 3500               | 80                         | SPHWH2L3D30ED4U☆K3 | K3        | N1       | 150 ~ 160                        |
|                    |                            |                    |           | P1       | 160 ~ 170                        |
|                    |                            |                    |           | Q1       | 170 ~ 180                        |
|                    |                            | SPHWH2L3D30ED4U☆M3 | M3        | K1       | 130 ~ 140                        |
|                    |                            |                    |           | M1       | 140 ~ 150                        |
|                    |                            |                    |           | N1       | 150 ~ 160                        |
| 4000               | 70                         | SPHWH2L3D30GD4U☆G3 | G3        | P1       | 160 ~ 170                        |
|                    |                            |                    |           | G1       | 100 ~ 110                        |
|                    |                            |                    |           | H1       | 110 ~ 120                        |
|                    |                            | SPHWH2L3D30GD4U☆H3 | H3        | J1       | 120 ~ 130                        |
|                    |                            |                    |           | H1       | 110 ~ 120                        |
|                    |                            |                    |           | K1       | 130 ~ 140                        |
| SPHWH2L3D30CD4T☆N3 | N3                         | N1                 | 150 ~ 160 |          |                                  |
|                    |                            | P1                 | 160 ~ 170 |          |                                  |
|                    |                            | Q1                 | 170 ~ 180 |          |                                  |
| SPHWH2L3D30CD4T☆P3 | P3                         | P1                 | 160 ~ 170 |          |                                  |
|                    |                            | Q1                 | 170 ~ 180 |          |                                  |
|                    |                            | R1                 | 180 ~ 190 |          |                                  |

"☆" can be "0" (Whole bin), "P" (Quarter bin), or "M" (MacAdam 3-step ellipse bin) of the color binning

**a) Luminous Flux Bins ( $I_f = 350 \text{ mA}$ ,  $T_j = 85 \text{ }^\circ\text{C}$ )**

| Nominal CCT (K)    | CRI (R <sub>a</sub> ) Min. | Product Code       | Flux Rank | Flux Bin  | Flux Range ( $\Phi_v$ , lm) |
|--------------------|----------------------------|--------------------|-----------|-----------|-----------------------------|
| 4000               | 80                         | SPHWH2L3D30ED4T☆K3 | K3        | K1        | 130 ~ 140                   |
|                    |                            |                    |           | M1        | 140 ~ 150                   |
|                    |                            |                    |           | N1        | 150 ~ 160                   |
|                    |                            | SPHWH2L3D30ED4T☆M3 | M3        | M1        | 140 ~ 150                   |
|                    |                            |                    |           | N1        | 150 ~ 160                   |
|                    |                            |                    |           | P1        | 160 ~ 170                   |
|                    | 90                         | SPHWH2L3D30GD4T0J3 | J3        | J1        | 120 ~ 130                   |
|                    |                            |                    |           | K1        | 130 ~ 140                   |
|                    |                            |                    |           | M1        | 140 ~ 150                   |
|                    |                            | SPHWH2L3D30GD4TPJ3 | J3        | J1        | 120 ~ 130                   |
|                    |                            |                    |           | K1        | 130 ~ 140                   |
|                    |                            |                    |           | M1        | 140 ~ 150                   |
| 5000               | 70                         | SPHWH2L3D30CD4RTM3 | M3        | M1        | 140 ~ 150                   |
|                    |                            |                    |           | N1        | 150 ~ 160                   |
|                    |                            |                    |           | P1        | 160 ~ 170                   |
|                    |                            | SPHWH2L3D30CD4RTN3 | N3        | N1        | 150 ~ 160                   |
|                    |                            |                    |           | P1        | 160 ~ 170                   |
|                    |                            |                    |           | Q1        | 170 ~ 180                   |
|                    | SPHWH2L3D30CD4RTP3         | P3                 | P1        | 160 ~ 170 |                             |
|                    |                            |                    | Q1        | 170 ~ 180 |                             |
|                    |                            |                    | R1        | 180 ~ 190 |                             |
|                    | 80                         | SPHWH2L3D30CD4RTQ2 | Q2        | Q1        | 170 ~ 180                   |
|                    |                            |                    |           | R1        | 180 ~ 190                   |
|                    |                            |                    |           | M1        | 140 ~ 150                   |
| SPHWH2L3D30ED4RTM3 |                            | M3                 | N1        | 150 ~ 160 |                             |
|                    |                            |                    | P1        | 160 ~ 170 |                             |
|                    |                            |                    | N1        | 150 ~ 160 |                             |
| SPHWH2L3D30ED4RTN3 | N3                         | P1                 | 160 ~ 170 |           |                             |
|                    |                            | Q1                 | 170 ~ 180 |           |                             |
|                    |                            | K1                 | 130 ~ 140 |           |                             |
| 90                 | SPHWH2L3D30GD4RTK3         | K3                 | M1        | 140 ~ 150 |                             |
|                    |                            |                    | N1        | 150 ~ 160 |                             |

"☆" can be "0" (Whole bin), "P" (Quarter bin), or "M" (MacAdam 3-step ellipse bin) of the color binning

a) Luminous Flux Bins ( $I_f = 350 \text{ mA}$ ,  $T_j = 85 \text{ }^\circ\text{C}$ )

| Nominal CCT (K) | CRI (R <sub>a</sub> ) Min. | Product Code        | Flux Rank          | Flux Bin  | Flux Range (Φ <sub>v</sub> , lm) |           |
|-----------------|----------------------------|---------------------|--------------------|-----------|----------------------------------|-----------|
| 5700            | 70                         | SPHWH2L3D30CD4QTN3  | N3                 | N1        | 150 ~ 160                        |           |
|                 |                            |                     |                    | P1        | 160 ~ 170                        |           |
|                 |                            |                     |                    | Q1        | 170 ~ 180                        |           |
|                 | 80                         | SPHWH2L3D30CD4QTP3  | P3                 | P1        | 160 ~ 170                        |           |
|                 |                            |                     |                    | Q1        | 170 ~ 180                        |           |
|                 |                            |                     |                    | R1        | 180 ~ 190                        |           |
| 6000            | 80                         | SPHWH2L3D30ED4QTM3  | M3                 | M1        | 140 ~ 150                        |           |
|                 |                            |                     |                    | N1        | 150 ~ 160                        |           |
|                 |                            |                     |                    | P1        | 160 ~ 170                        |           |
|                 |                            | 70                  | SPHWH2L3D30ED4PQK3 | K3        | K1                               | 130 ~ 140 |
|                 |                            |                     |                    |           | M1                               | 140 ~ 150 |
|                 |                            |                     |                    |           | N1                               | 150 ~ 160 |
|                 | 6500                       | 80                  | SPHWH2L3D30ED4PQM3 | M3        | M1                               | 140 ~ 150 |
|                 |                            |                     |                    |           | N1                               | 150 ~ 160 |
|                 |                            |                     |                    |           | P1                               | 160 ~ 170 |
|                 |                            | 70                  | SPHWH2L3D30CD4PTM3 | M3        | N1                               | 150 ~ 160 |
|                 |                            |                     |                    |           | P1                               | 160 ~ 170 |
|                 |                            |                     |                    |           | N1                               | 150 ~ 160 |
| 80              | SPHWH2L3D30CD4PTN3         |                     | N3                 | P1        | 160 ~ 170                        |           |
|                 |                            |                     |                    | Q1        | 170 ~ 180                        |           |
|                 |                            |                     |                    | P1        | 160 ~ 170                        |           |
| 6500            | 70                         | SPHWH2L3D30CD4PTNP3 | P3                 | Q1        | 170 ~ 180                        |           |
|                 |                            |                     |                    | R1        | 180 ~ 190                        |           |
|                 |                            |                     |                    | K1        | 130 ~ 140                        |           |
|                 | 80                         | SPHWH2L3D30ED4PTK3  | K3                 | M1        | 140 ~ 150                        |           |
|                 |                            |                     |                    | N1        | 150 ~ 160                        |           |
|                 |                            |                     |                    | M1        | 140 ~ 150                        |           |
| 80              | SPHWH2L3D30ED4PTM3         | M3                  | N1                 | 150 ~ 160 |                                  |           |
|                 |                            |                     | P1                 | 160 ~ 170 |                                  |           |

"☆" can be "0" (Whole bin), "P" (Quarter bin), or "M" (MacAdam 3-step ellipse bin) of the color binning

b) Color Bins ( $I_F = 350 \text{ mA}$ ,  $T_j = 85 \text{ }^\circ\text{C}$ )

| Nominal CCT (K)    | CRI (R <sub>a</sub> ) Min. | Product Code       | Color Rank             | Chromaticity Bins   |                   |   |
|--------------------|----------------------------|--------------------|------------------------|---|-------------------|---|
| 2200               | 80                         | SPHWH2L3D30ED4Y0G3 | Y0<br>(Whole bin)      | Y1, Y2, Y3, Y4, Y5, Y6, Y7, Y8,<br>Y9, YA, YB, YC, YD, YE, YF, YG |                   |   |
|                    |                            | SPHWH2L3D30ED4YPG3 | YP<br>(Quarter bin)    | Y6, Y7, YA, YB  |                   |   |
|                    |                            | SPHWH2L3D30ED4YMG3 | YM<br>(MacAdam 3-step) | YM  |                   |   |
| 2700               | 70                         | SPHWH2L3D30CD4W0K3 | W0<br>(Whole bin)      | W1, W2, W3, W4, W5, W6, W7, W8,<br>W9, WA, WB, WC, WD, WE, WF, WG |                   |   |
|                    |                            | SPHWH2L3D30CD4W0M3 |                        |   |                   |   |
|                    |                            | SPHWH2L3D30CD4W0N3 |                        |   |                   |   |
|                    |                            | SPHWH2L3D30CD4WPK3 | WP<br>(Quarter bin)    | W6, W7, WA, WB  |                   |   |
|                    |                            | SPHWH2L3D30CD4WPM3 |                        |   |                   |   |
|                    |                            | SPHWH2L3D30CD4WPN3 | WM<br>(MacAdam 3-step) | WM  |                   |   |
|                    |                            | SPHWH2L3D30CD4WMK3 |                        |   |                   |   |
|                    |                            | SPHWH2L3D30CD4WMM3 |                        |   |                   |   |
|                    |                            | 2700               | 80                     | SPHWH2L3D30ED4W0J3  | W0 (Whole bin)    | W1, W2, W3, W4, W5, W6, W7, W8,<br>W9, WA, WB, WC, WD, WE, WF, WG |
|                    |                            |                    |                        | SPHWH2L3D30ED4W0K3  |                   |   |
| SPHWH2L3D30ED4W0L3 |                            |                    |                        |   |                   |   |
| SPHWH2L3D30ED4WPK3 | WP<br>(Quarter bin)        |                    |                        | W6, W7, WA, WB  |                   |   |
| SPHWH2L3D30ED4WPM3 |                            |                    |                        |   |                   |   |
| SPHWH2L3D30ED4WMM3 | WM<br>(MacAdam 3-step)     |                    |                        | WM  |                   |   |
| SPHWH2L3D30ED4WML3 |                            |                    |                        |   |                   |   |
| SPHWH2L3D30ED4W0F3 |                            |                    |                        |   |                   |   |
| 2700               | 90                         |                    |                        | SPHWH2L3D30GD4W0G3  | W0 (Whole bin)    | W1, W2, W3, W4, W5, W6, W7, W8,<br>W9, WA, WB, WC, WD, WE, WF, WG |
|                    |                            |                    |                        | SPHWH2L3D30GD4W0J3  |                   |   |
|                    |                            | SPHWH2L3D30GD4W0K3 |                        |   |                   |   |
|                    |                            | SPHWH2L3D30GD4WPF3 | WP<br>(Quarter bin)    | W6, W7, WA, WB  |                   |   |
|                    |                            | SPHWH2L3D30GD4WPG3 |                        |   |                   |   |
|                    |                            | SPHWH2L3D30GD4W0M3 | WM<br>(MacAdam 3-step) | WM  |                   |   |
|                    |                            | SPHWH2L3D30GD4W0N3 |                        |   |                   |   |
|                    |                            | SPHWH2L3D30GD4W0L3 |                        |   |                   |   |
|                    |                            | 3000               | 70                     | SPHWH2L3D30CD4V0M3  | V0<br>(Whole bin) | V1, V2, V3, V4, V5, V6, V7, V8,<br>V9, VA, VB, VC, VD, VE, VF, VG |
|                    |                            |                    |                        | SPHWH2L3D30CD4V0N3  |                   |   |
| SPHWH2L3D30CD4V0J3 |                            |                    |                        |   |                   |   |
| SPHWH2L3D30CD4VPM3 | VP<br>(Quarter bin)        |                    |                        | V6, V7, VA, VB  |                   |   |
| SPHWH2L3D30CD4VPN3 |                            |                    |                        |   |                   |   |
| SPHWH2L3D30CD4VMM3 | VM<br>(MacAdam 3-step)     |                    |                        | VM  |                   |   |
| SPHWH2L3D30CD4VMN3 |                            |                    |                        |   |                   |   |
| SPHWH2L3D30ED4V0J3 |                            |                    |                        |   |                   |   |
| 3000               | 80                         |                    |                        | SPHWH2L3D30ED4V0K3  | V0<br>(Whole bin) | V1, V2, V3, V4, V5, V6, V7, V8,<br>V9, VA, VB, VC, VD, VE, VF, VG |
|                    |                            |                    |                        | SPHWH2L3D30ED4V0M3  |                   |   |
|                    |                            | SPHWH2L3D30ED4V0L3 |                        |   |                   |   |
|                    |                            | SPHWH2L3D30ED4VPJ3 | VP<br>(Quarter bin)    | V6, V7, VA, VB  |                   |   |
|                    |                            | SPHWH2L3D30ED4VPK3 |                        |   |                   |   |
|                    |                            | SPHWH2L3D30ED4VPM3 | VM<br>(MacAdam 3-step) | VM  |                   |   |
|                    |                            | SPHWH2L3D30ED4VMJ3 |                        |   |                   |   |
|                    |                            | SPHWH2L3D30ED4VMK3 |                        |   |                   |   |
|                    |                            | SPHWH2L3D30ED4VMM3 |                        |   |                   |   |

b) Color Bins ( $I_F = 350 \text{ mA}$ ,  $T_j = 85 \text{ °C}$ )

| Nominal CCT (K)    | CRI ( $R_a$ ) Min. | Product Code       | Color Rank             | Chromaticity Bins   |   |
|--------------------|--------------------|--------------------|------------------------|---|---|
| 3000               | 90                 | SPHWH2L3D30GD4V0G3 | V0<br>(Whole bin)      | V1, V2, V3, V4, V5, V6, V7, V8,<br>V9, VA, VB, VC, VD, VE, VF, VG |   |
|                    |                    | SPHWH2L3D30GD4V0H3 |                        |   |   |
|                    |                    | SPHWH2L3D30GD4VPG3 | VP<br>(Quarter bin)    |   |   |
|                    |                    | SPHWH2L3D30GD4VPH3 |                        |   |   |
|                    |                    | SPHWH2L3D30GD4VMG3 | VM<br>(MacAdam 3-step) |   | VM  |
|                    | SPHWH2L3D30GD4VMH3 |                    |                        |   |   |
|                    | 3500               | 70                 | SPHWH2L3D30CD4U0K3     | U0<br>(Whole bin)   | U1, U2, U3, U4, U5, U6, U7, U8,<br>U9, UA, UB, UC, UD, UE, UF, UG |
|                    |                    |                    | SPHWH2L3D30CD4U0M3     |   |   |
|                    |                    |                    | SPHWH2L3D30CD4U0N3     | UP<br>(Quarter bin)   |   |
|                    |                    |                    | SPHWH2L3D30CD4UPK3     |   |   |
| SPHWH2L3D30CD4UPM3 |                    |                    | UM<br>(MacAdam 3-step) | UM  |   |
| SPHWH2L3D30CD4UPN3 |                    |                    |                        |   |   |
| 3500               |                    | 80                 | SPHWH2L3D30ED4U0K3     | U0<br>(Whole bin)   | U1, U2, U3, U4, U5, U6, U7, U8,<br>U9, UA, UB, UC, UD, UE, UF, UG |
|                    |                    |                    | SPHWH2L3D30ED4U0M3     |   |   |
|                    |                    |                    | SPHWH2L3D30ED4UPK3     | UP<br>(Quarter bin)   |   |
|                    |                    |                    | SPHWH2L3D30ED4UPM3     |   |   |
|                    | SPHWH2L3D30ED4UMK3 |                    | UM<br>(MacAdam 3-step) | UM  |   |
|                    | SPHWH2L3D30ED4UMM3 |                    |                        |   |   |
|                    | 4000               | 90                 | SPHWH2L3D30GD4U0G3     | U0<br>(Whole bin)   | U1, U2, U3, U4, U5, U6, U7, U8,<br>U9, UA, UB, UC, UD, UE, UF, UG |
|                    |                    |                    | SPHWH2L3D30GD4U0H3     |   |   |
|                    |                    |                    | SPHWH2L3D30GD4UPG3     | UP<br>(Quarter bin)   |   |
|                    |                    |                    | SPHWH2L3D30GD4UPH3     |   |   |
| SPHWH2L3D30GD4UMG3 |                    |                    | UM<br>(MacAdam 3-step) | UM  |   |
| SPHWH2L3D30GD4UMH3 |                    |                    |                        |   |   |
| 4000               |                    | 70                 | SPHWH2L3D30CD4T0N3     | T0<br>(Whole bin)   | T1, T2, T3, T4, T5, T6, T7, T8,<br>T9, TA, TB, TC, TD, TE, TF, TG |
|                    |                    |                    | SPHWH2L3D30CD4T0P3     |   |   |
|                    |                    |                    | SPHWH2L3D30CD4TPN3     | TP<br>(Quarter bin)   |   |
|                    |                    |                    | SPHWH2L3D30CD4TPP3     |   |   |
|                    | SPHWH2L3D30CD4TMN3 |                    | TM<br>(MacAdam 3-step) | TM  |   |
|                    | SPHWH2L3D30CD4TMP3 |                    |                        |   |   |
|                    | 4000               | 80                 | SPHWH2L3D30ED4T0K3     | T0<br>(Whole bin)   | T1, T2, T3, T4, T5, T6, T7, T8,<br>T9, TA, TB, TC, TD, TE, TF, TG |
|                    |                    |                    | SPHWH2L3D30ED4T0M3     |   |   |
|                    |                    |                    | SPHWH2L3D30ED4TPK3     | TP<br>(Quarter bin)   |   |
|                    |                    |                    | SPHWH2L3D30ED4TPM3     |   |   |
| SPHWH2L3D30ED4TMK3 |                    |                    | TM<br>(MacAdam 3-step) | TM  |   |
| SPHWH2L3D30ED4TMM3 |                    |                    |                        |   |   |

**b) Color Bins (I<sub>F</sub> = 350 mA, T<sub>j</sub> = 85 °C)**

| Nominal CCT (K) | CRI (R <sub>a</sub> ) Min. | Product Code       | Color Rank          | Chromaticity Bins   |
|-----------------|----------------------------|--------------------|---------------------|---|
| 4000            | 90                         | SPHWH2L3D30GD4T0J3 | T0<br>(Whole bin)   | T1, T2, T3, T4, T5, T6, T7, T8,<br>T9, TA, TB, TC, TD, TE, TF, TG |
|                 |                            | SPHWH2L3D30GD4TPJ3 | TP<br>(Quarter bin) | T6, T7, TA, TB  |
| 5000            | 70                         | SPHWH2L3D30CD4RTM3 | RT<br>(Half bin)    | R1, R2, R3, R4  |
|                 |                            | SPHWH2L3D30CD4RTN3 |                     |   |
|                 |                            | SPHWH2L3D30CD4RTP3 |                     |   |
|                 | 80                         | SPHWH2L3D30CD4RTQ2 |                     |   |
|                 | SPHWH2L3D30ED4RTM3         |                    |                     |   |
|                 | SPHWH2L3D30ED4RTN3         |                    |                     |   |
| 5700            | 90                         | SPHWH2L3D30GD4RTK3 | QT<br>(Half bin)    | Q1, Q2, Q3, Q4  |
|                 | 70                         | SPHWH2L3D30CD4QTN3 |                     |   |
|                 | SPHWH2L3D30CD4QTP3         |                    |                     |   |
| 6000            | 80                         | SPHWH2L3D30ED4PQM3 | PQ<br>(Half bin)    | Q1, Q3, P2, P4  |
|                 |                            | SPHWH2L3D30ED4PQK3 |                     |   |
| 6500            | 70                         | SPHWH2L3D30CD4PTM3 | PT<br>(Half bin)    | P1, P2, P3, P4  |
|                 |                            | SPHWH2L3D30CD4PTN3 |                     |   |
|                 | SPHWH2L3D30CD4PTP3         |                    |                     |   |
|                 | 80                         | SPHWH2L3D30ED4PTK3 |                     |   |
|                 |                            | SPHWH2L3D30ED4PTM3 |                     |   |

**c) Voltage Bins (I<sub>F</sub> = 350 mA, T<sub>j</sub> = 85 °C)**

| Nominal CCT (K) | CRI (R <sub>a</sub> ) Min. | Product Code | Voltage Rank | Voltage Bin | Voltage Range (V) |
|-----------------|----------------------------|--------------|--------------|-------------|-------------------|
| -               | -                          | -            | D4           | D2          | 2.6 ~ 2.8         |
|                 |                            |              |              | F2          | 2.8 ~ 3.0         |

d) Chromaticity Region & Coordinates ( $I_f = 350 \text{ mA}$ ,  $T_j = 85^\circ \text{C}$ )

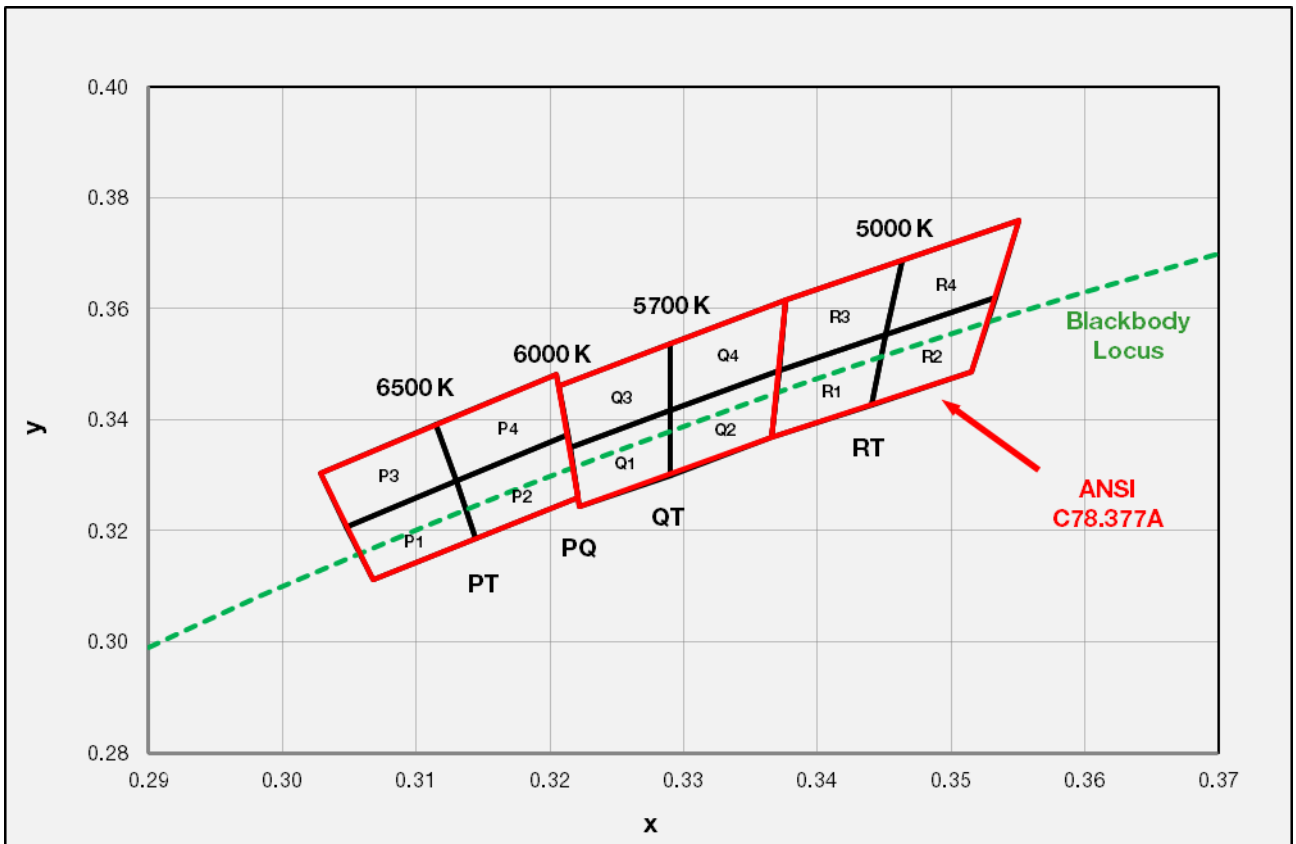
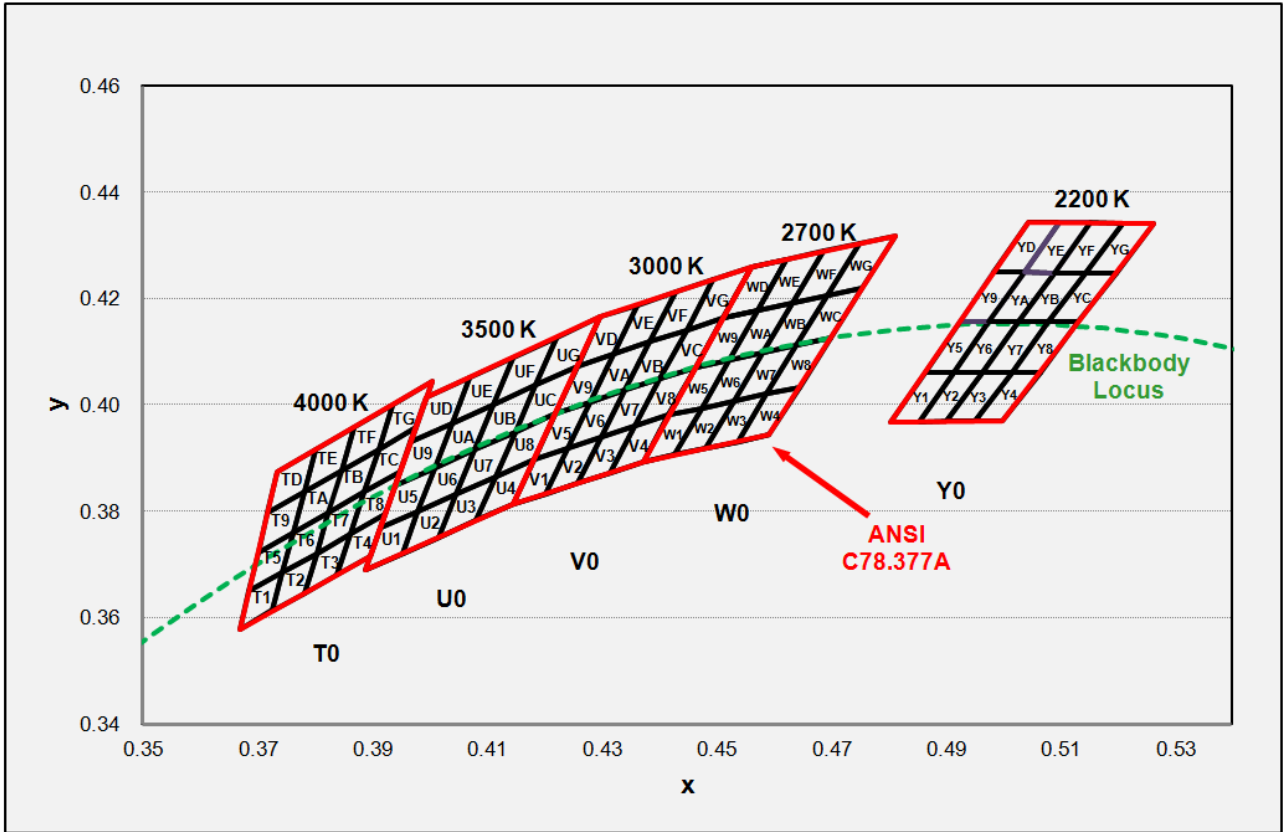

d) Chromaticity Region & Coordinates ( $I_F = 350 \text{ mA}$ ,  $T_j = 85 \text{ }^\circ\text{C}$ )

| Region                 | CIE x  | CIE y  | Region | CIE x  | CIE y  |
|------------------------|--------|--------|--------|--------|--------|
| <b>Y rank (2200 K)</b> |        |        |        |        |        |
| Y1                     | 0.4805 | 0.3968 | Y9     | 0.4925 | 0.4156 |
|                        | 0.4854 | 0.3968 |        | 0.4976 | 0.4156 |
|                        | 0.4915 | 0.4062 |        | 0.5038 | 0.4250 |
|                        | 0.4865 | 0.4062 |        | 0.4984 | 0.4250 |
| Y2                     | 0.4854 | 0.3968 | YA     | 0.4976 | 0.4156 |
|                        | 0.4903 | 0.3969 |        | 0.5028 | 0.4156 |
|                        | 0.4966 | 0.4062 |        | 0.5091 | 0.4249 |
|                        | 0.4915 | 0.4062 |        | 0.5038 | 0.4250 |
| Y3                     | 0.4903 | 0.3969 | YB     | 0.5028 | 0.4156 |
|                        | 0.4952 | 0.3969 |        | 0.5080 | 0.4156 |
|                        | 0.5016 | 0.4062 |        | 0.5145 | 0.4249 |
|                        | 0.4966 | 0.4062 |        | 0.5091 | 0.4249 |
| Y4                     | 0.4952 | 0.3969 | YC     | 0.5080 | 0.4156 |
|                        | 0.5000 | 0.3969 |        | 0.5132 | 0.4156 |
|                        | 0.5066 | 0.4062 |        | 0.5198 | 0.4249 |
|                        | 0.5016 | 0.4062 |        | 0.5145 | 0.4249 |
| Y5                     | 0.4865 | 0.4062 | YD     | 0.4984 | 0.4250 |
|                        | 0.4915 | 0.4062 |        | 0.5038 | 0.4250 |
|                        | 0.4976 | 0.4156 |        | 0.5099 | 0.4344 |
|                        | 0.4925 | 0.4156 |        | 0.5044 | 0.4344 |
| Y6                     | 0.4915 | 0.4062 | YE     | 0.5038 | 0.4250 |
|                        | 0.4966 | 0.4062 |        | 0.5091 | 0.4249 |
|                        | 0.5028 | 0.4156 |        | 0.5154 | 0.4343 |
|                        | 0.4976 | 0.4156 |        | 0.5099 | 0.4344 |
| Y7                     | 0.4966 | 0.4062 | YF     | 0.5091 | 0.4249 |
|                        | 0.5016 | 0.4062 |        | 0.5145 | 0.4249 |
|                        | 0.508  | 0.4156 |        | 0.5209 | 0.4342 |
|                        | 0.5028 | 0.4156 |        | 0.5154 | 0.4343 |
| Y8                     | 0.5016 | 0.4062 | YG     | 0.5145 | 0.4249 |
|                        | 0.5066 | 0.4062 |        | 0.5198 | 0.4249 |
|                        | 0.5132 | 0.4156 |        | 0.5264 | 0.4342 |
|                        | 0.5080 | 0.4156 |        | 0.5209 | 0.4342 |

| Region                 | CIE x  | CIE y  | Region | CIE x  | CIE y  |
|------------------------|--------|--------|--------|--------|--------|
| <b>W rank (2700 K)</b> |        |        |        |        |        |
| W1                     | 0.4373 | 0.3893 | W9     | 0.4465 | 0.4071 |
|                        | 0.4418 | 0.3981 |        | 0.4513 | 0.4164 |
|                        | 0.4475 | 0.3994 |        | 0.4573 | 0.4178 |
|                        | 0.4428 | 0.3906 |        | 0.4523 | 0.4085 |
| W2                     | 0.4428 | 0.3906 | WA     | 0.4523 | 0.4085 |
|                        | 0.4475 | 0.3994 |        | 0.4573 | 0.4178 |
|                        | 0.4532 | 0.4008 |        | 0.4634 | 0.4193 |
|                        | 0.4483 | 0.3919 |        | 0.4582 | 0.4099 |
| W3                     | 0.4483 | 0.3919 | WB     | 0.4582 | 0.4099 |
|                        | 0.4532 | 0.4008 |        | 0.4634 | 0.4193 |
|                        | 0.4589 | 0.4021 |        | 0.4695 | 0.4207 |
|                        | 0.4538 | 0.3931 |        | 0.4641 | 0.4112 |
| W4                     | 0.4538 | 0.3931 | WC     | 0.4641 | 0.4112 |
|                        | 0.4589 | 0.4021 |        | 0.4695 | 0.4207 |
|                        | 0.4646 | 0.4034 |        | 0.4756 | 0.4221 |
|                        | 0.4593 | 0.3944 |        | 0.4700 | 0.4126 |
| W5                     | 0.4418 | 0.3981 | WD     | 0.4513 | 0.4164 |
|                        | 0.4465 | 0.4071 |        | 0.4562 | 0.4260 |
|                        | 0.4523 | 0.4085 |        | 0.4624 | 0.4274 |
|                        | 0.4475 | 0.3994 |        | 0.4573 | 0.4178 |
| W6                     | 0.4475 | 0.3994 | WE     | 0.4573 | 0.4178 |
|                        | 0.4523 | 0.4085 |        | 0.4624 | 0.4274 |
|                        | 0.4582 | 0.4099 |        | 0.4687 | 0.4289 |
|                        | 0.4532 | 0.4008 |        | 0.4634 | 0.4193 |
| W7                     | 0.4532 | 0.4008 | WF     | 0.4634 | 0.4193 |
|                        | 0.4582 | 0.4099 |        | 0.4687 | 0.4289 |
|                        | 0.4641 | 0.4112 |        | 0.4750 | 0.4304 |
|                        | 0.4589 | 0.4021 |        | 0.4695 | 0.4207 |
| W8                     | 0.4589 | 0.4021 | WG     | 0.4695 | 0.4207 |
|                        | 0.4641 | 0.4112 |        | 0.4750 | 0.4304 |
|                        | 0.4700 | 0.4126 |        | 0.4813 | 0.4319 |
|                        | 0.4646 | 0.4034 |        | 0.4756 | 0.4221 |



## d) Chromaticity Region &amp; Coordinates

| Region                 | CIE x  | CIE y  | Region | CIE x  | CIE y  |
|------------------------|--------|--------|--------|--------|--------|
| <b>V rank (3000 K)</b> |        |        |        |        |        |
| V1                     | 0.4147 | 0.3814 | V9     | 0.4221 | 0.3984 |
|                        | 0.4183 | 0.3898 |        | 0.4259 | 0.4073 |
|                        | 0.4242 | 0.3919 |        | 0.4322 | 0.4096 |
|                        | 0.4203 | 0.3833 |        | 0.4281 | 0.4006 |
| V2                     | 0.4203 | 0.3833 | VA     | 0.4281 | 0.4006 |
|                        | 0.4242 | 0.3919 |        | 0.4322 | 0.4096 |
|                        | 0.4300 | 0.3939 |        | 0.4385 | 0.4119 |
|                        | 0.4259 | 0.3853 |        | 0.4342 | 0.4028 |
| V3                     | 0.4259 | 0.3853 | VB     | 0.4342 | 0.4028 |
|                        | 0.4300 | 0.3939 |        | 0.4385 | 0.4119 |
|                        | 0.4359 | 0.3960 |        | 0.4449 | 0.4141 |
|                        | 0.4316 | 0.3873 |        | 0.4403 | 0.4049 |
| V4                     | 0.4316 | 0.3873 | VC     | 0.4403 | 0.4049 |
|                        | 0.4359 | 0.3960 |        | 0.4449 | 0.4141 |
|                        | 0.4418 | 0.3981 |        | 0.4513 | 0.4164 |
|                        | 0.4373 | 0.3893 |        | 0.4465 | 0.4071 |
| V5                     | 0.4183 | 0.3898 | VD     | 0.4259 | 0.4073 |
|                        | 0.4221 | 0.3984 |        | 0.4299 | 0.4165 |
|                        | 0.4281 | 0.4006 |        | 0.4364 | 0.4188 |
|                        | 0.4242 | 0.3919 |        | 0.4322 | 0.4096 |
| V6                     | 0.4242 | 0.3919 | VE     | 0.4322 | 0.4096 |
|                        | 0.4281 | 0.4006 |        | 0.4364 | 0.4188 |
|                        | 0.4342 | 0.4028 |        | 0.4430 | 0.4212 |
|                        | 0.4300 | 0.3939 |        | 0.4385 | 0.4119 |
| V7                     | 0.4300 | 0.3939 | VF     | 0.4385 | 0.4119 |
|                        | 0.4342 | 0.4028 |        | 0.4430 | 0.4212 |
|                        | 0.4403 | 0.4049 |        | 0.4496 | 0.4236 |
|                        | 0.4359 | 0.3960 |        | 0.4449 | 0.4141 |
| V8                     | 0.4359 | 0.3960 | VG     | 0.4449 | 0.4141 |
|                        | 0.4403 | 0.4049 |        | 0.4496 | 0.4236 |
|                        | 0.4465 | 0.4071 |        | 0.4562 | 0.4260 |
|                        | 0.4418 | 0.3981 |        | 0.4513 | 0.4164 |

| Region                 | CIE x  | CIE y  | Region | CIE x  | CIE y  |
|------------------------|--------|--------|--------|--------|--------|
| <b>U rank (3500 K)</b> |        |        |        |        |        |
| U1                     | 0.3889 | 0.3690 | U9     | 0.3941 | 0.3848 |
|                        | 0.3915 | 0.3768 |        | 0.3968 | 0.3930 |
|                        | 0.3981 | 0.3800 |        | 0.4040 | 0.3966 |
|                        | 0.3953 | 0.3720 |        | 0.4010 | 0.3882 |
| U2                     | 0.3953 | 0.3720 | UA     | 0.4010 | 0.3882 |
|                        | 0.3981 | 0.3800 |        | 0.4040 | 0.3966 |
|                        | 0.4048 | 0.3832 |        | 0.4113 | 0.4001 |
|                        | 0.4017 | 0.3751 |        | 0.4080 | 0.3916 |
| U3                     | 0.4017 | 0.3751 | UB     | 0.4080 | 0.3916 |
|                        | 0.4048 | 0.3832 |        | 0.4113 | 0.4001 |
|                        | 0.4116 | 0.3865 |        | 0.4186 | 0.4037 |
|                        | 0.4082 | 0.3782 |        | 0.4150 | 0.3950 |
| U4                     | 0.4082 | 0.3782 | UC     | 0.4150 | 0.3950 |
|                        | 0.4116 | 0.3865 |        | 0.4186 | 0.4037 |
|                        | 0.4183 | 0.3898 |        | 0.4259 | 0.4073 |
|                        | 0.4147 | 0.3814 |        | 0.4221 | 0.3984 |
| U5                     | 0.3915 | 0.3768 | UD     | 0.3968 | 0.3930 |
|                        | 0.3941 | 0.3848 |        | 0.3996 | 0.4015 |
|                        | 0.4010 | 0.3882 |        | 0.4071 | 0.4052 |
|                        | 0.3981 | 0.3800 |        | 0.4040 | 0.3966 |
| U6                     | 0.3981 | 0.3800 | UE     | 0.4040 | 0.3966 |
|                        | 0.4010 | 0.3882 |        | 0.4071 | 0.4052 |
|                        | 0.4080 | 0.3916 |        | 0.4146 | 0.4089 |
|                        | 0.4048 | 0.3832 |        | 0.4113 | 0.4001 |
| U7                     | 0.4048 | 0.3832 | UF     | 0.4113 | 0.4001 |
|                        | 0.4080 | 0.3916 |        | 0.4146 | 0.4089 |
|                        | 0.4150 | 0.3950 |        | 0.4222 | 0.4127 |
|                        | 0.4116 | 0.3865 |        | 0.4186 | 0.4037 |
| U8                     | 0.4116 | 0.3865 | UG     | 0.4186 | 0.4037 |
|                        | 0.4150 | 0.3950 |        | 0.4222 | 0.4127 |
|                        | 0.4221 | 0.3984 |        | 0.4299 | 0.4165 |
|                        | 0.4183 | 0.3898 |        | 0.4259 | 0.4073 |

## d) Chromaticity Region &amp; Coordinates

| Region                 | CIE x  | CIE y  | Region | CIE x  | CIE y  |
|------------------------|--------|--------|--------|--------|--------|
| <b>T rank (4000 K)</b> |        |        |        |        |        |
| T1                     | 0.3670 | 0.3578 | T9     | 0.3702 | 0.3722 |
|                        | 0.3726 | 0.3612 |        | 0.3763 | 0.3760 |
|                        | 0.3744 | 0.3685 |        | 0.3782 | 0.3837 |
|                        | 0.3686 | 0.3649 |        | 0.3719 | 0.3797 |
| T2                     | 0.3726 | 0.3612 | TA     | 0.3763 | 0.3760 |
|                        | 0.3783 | 0.3646 |        | 0.3825 | 0.3798 |
|                        | 0.3804 | 0.3721 |        | 0.3847 | 0.3877 |
|                        | 0.3744 | 0.3685 |        | 0.3782 | 0.3837 |
| T3                     | 0.3783 | 0.3646 | TB     | 0.3825 | 0.3798 |
|                        | 0.3840 | 0.3681 |        | 0.3887 | 0.3836 |
|                        | 0.3863 | 0.3758 |        | 0.3912 | 0.3917 |
|                        | 0.3804 | 0.3721 |        | 0.3847 | 0.3877 |
| T4                     | 0.3840 | 0.3681 | TC     | 0.3887 | 0.3837 |
|                        | 0.3898 | 0.3716 |        | 0.3950 | 0.3875 |
|                        | 0.3924 | 0.3794 |        | 0.3978 | 0.3958 |
|                        | 0.3863 | 0.3758 |        | 0.3912 | 0.3917 |
| T5                     | 0.3686 | 0.3649 | TD     | 0.3719 | 0.3797 |
|                        | 0.3744 | 0.3685 |        | 0.3782 | 0.3837 |
|                        | 0.3763 | 0.3760 |        | 0.3802 | 0.3916 |
|                        | 0.3702 | 0.3722 |        | 0.3736 | 0.3874 |
| T6                     | 0.3744 | 0.3685 | TE     | 0.3782 | 0.3837 |
|                        | 0.3804 | 0.3721 |        | 0.3847 | 0.3877 |
|                        | 0.3825 | 0.3798 |        | 0.3869 | 0.3958 |
|                        | 0.3763 | 0.3760 |        | 0.3802 | 0.3916 |
| T7                     | 0.3804 | 0.3721 | TF     | 0.3847 | 0.3877 |
|                        | 0.3863 | 0.3758 |        | 0.3912 | 0.3917 |
|                        | 0.3887 | 0.3836 |        | 0.3937 | 0.4001 |
|                        | 0.3825 | 0.3798 |        | 0.3869 | 0.3958 |
| T8                     | 0.3863 | 0.3758 | TG     | 0.3912 | 0.3917 |
|                        | 0.3924 | 0.3794 |        | 0.3978 | 0.3958 |
|                        | 0.3950 | 0.3875 |        | 0.4006 | 0.4044 |
|                        | 0.3887 | 0.3836 |        | 0.3937 | 0.4001 |

d) Chromaticity Region & Coordinates

| Region                 | CIE x  | CIE y  | Region                  | CIE x  | CIE y  | Region                 | CIE x  | CIE y  | Region                  | CIE x  | CIE y  | Region                 | CIE x  | CIE y  |
|------------------------|--------|--------|-------------------------|--------|--------|------------------------|--------|--------|-------------------------|--------|--------|------------------------|--------|--------|
| <b>R rank (5000 K)</b> |        |        | <b>QR rank (5300 K)</b> |        |        | <b>Q rank (5700 K)</b> |        |        | <b>PQ rank (6000 K)</b> |        |        | <b>P rank (6500 K)</b> |        |        |
| R1                     | 0.3371 | 0.3490 | Q2                      | 0.3290 | 0.3417 | Q1                     | 0.3215 | 0.3350 | P2                      | 0.3144 | 0.3186 | P1                     | 0.3068 | 0.3113 |
|                        | 0.3451 | 0.3554 |                         | 0.3371 | 0.3490 |                        | 0.3290 | 0.3417 |                         | 0.3221 | 0.3261 |                        | 0.3144 | 0.3186 |
|                        | 0.344  | 0.3427 |                         | 0.3366 | 0.3369 |                        | 0.3290 | 0.330  |                         | 0.3213 | 0.3373 |                        | 0.3130 | 0.329  |
|                        | 0.3366 | 0.3369 |                         | 0.3290 | 0.3300 |                        | 0.3222 | 0.3243 |                         | 0.3130 | 0.3290 |                        | 0.3048 | 0.3207 |
| R2                     | 0.3451 | 0.3554 | R1                      | 0.3371 | 0.3490 | Q2                     | 0.3290 | 0.3417 | Q1                      | 0.3215 | 0.335  | P2                     | 0.3144 | 0.3186 |
|                        | 0.3533 | 0.3620 |                         | 0.3451 | 0.3554 |                        | 0.3371 | 0.3490 |                         | 0.3290 | 0.3417 |                        | 0.3221 | 0.3261 |
|                        | 0.3515 | 0.3487 |                         | 0.3440 | 0.3427 |                        | 0.3366 | 0.3369 |                         | 0.3290 | 0.3300 |                        | 0.3213 | 0.3373 |
|                        | 0.3404 | 0.3427 |                         | 0.3366 | 0.3369 |                        | 0.3290 | 0.3300 |                         | 0.3222 | 0.3243 |                        | 0.3130 | 0.3290 |
| R3                     | 0.3376 | 0.3616 | Q4                      | 0.3290 | 0.3538 | Q3                     | 0.3207 | 0.3462 | P4                      | 0.3130 | 0.3290 | P3                     | 0.3048 | 0.3207 |
|                        | 0.3463 | 0.3687 |                         | 0.3376 | 0.3616 |                        | 0.3290 | 0.3538 |                         | 0.3213 | 0.3373 |                        | 0.3130 | 0.3290 |
|                        | 0.3451 | 0.3554 |                         | 0.3371 | 0.3490 |                        | 0.3290 | 0.3417 |                         | 0.3205 | 0.3481 |                        | 0.3115 | 0.3391 |
|                        | 0.3371 | 0.349  |                         | 0.3290 | 0.3417 |                        | 0.3215 | 0.3350 |                         | 0.3115 | 0.3391 |                        | 0.3028 | 0.3304 |
| R4                     | 0.3463 | 0.3687 | R3                      | 0.3376 | 0.3616 | Q4                     | 0.3290 | 0.3538 | Q3                      | 0.3207 | 0.3462 | P4                     | 0.3130 | 0.3290 |
|                        | 0.3551 | 0.3760 |                         | 0.3463 | 0.3687 |                        | 0.3376 | 0.3616 |                         | 0.3290 | 0.3538 |                        | 0.3213 | 0.3373 |
|                        | 0.3533 | 0.3620 |                         | 0.3451 | 0.3554 |                        | 0.3371 | 0.3490 |                         | 0.3290 | 0.3417 |                        | 0.3205 | 0.3481 |
|                        | 0.3451 | 0.3554 |                         | 0.3371 | 0.3490 |                        | 0.3290 | 0.3417 |                         | 0.3215 | 0.3350 |                        | 0.3115 | 0.3391 |

e) MacAdam 3-step Ellipse ( $I_F = 350 \text{ mA}$ ,  $T_j = 85 \text{ }^\circ\text{C}$ )

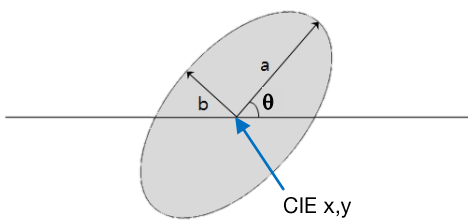

| Nom. CCT (K) | Color Rank | Center |        | Rotation Angle $\theta$ ( $^\circ$ ) | a      | b      |
|--------------|------------|--------|--------|--------------------------------------|--------|--------|
|              |            | CIE x  | CIE y  |                                      |        |        |
| 2200         | YM         | 0.5018 | 0.4153 | 53.45                                | 0.0072 | 0.0040 |
| 2700         | WM         | 0.4578 | 0.4101 | 53.70                                | 0.0081 | 0.0042 |
| 3000         | VM         | 0.4338 | 0.4030 | 53.22                                | 0.0083 | 0.0041 |
| 3500         | UM         | 0.4073 | 0.3917 | 54.00                                | 0.0093 | 0.0041 |
| 4000         | TM         | 0.3818 | 0.3797 | 53.72                                | 0.0094 | 0.0040 |

Note:

Samsung maintains measurement tolerance of:  $C_x, C_y = \pm 0.005$

### 3. Typical Characteristics Graphs

#### a) Spectrum Distribution ( $I_f = 350 \text{ mA}$ , $T_j = 85 \text{ }^\circ\text{C}$ )

Cool White (CRI70)

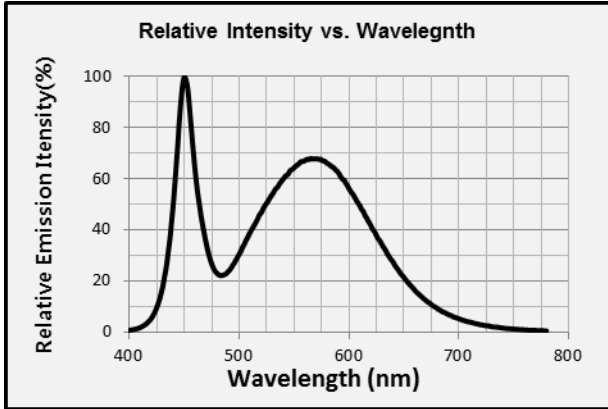

Warm White (CRI80)

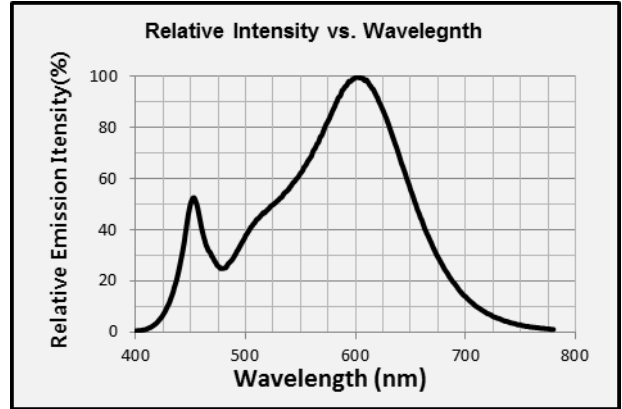

Warm White (CRI90)

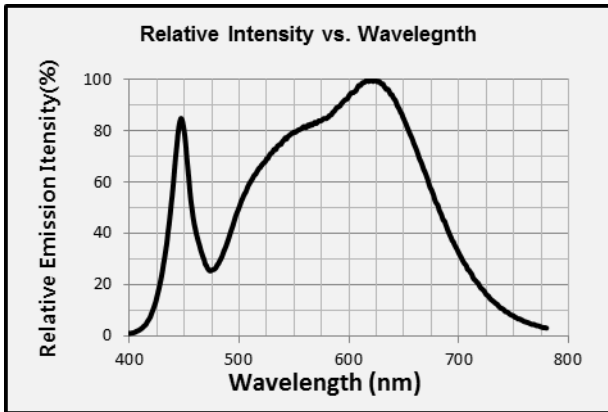

#### b) Forward Current Characteristics ( $T_j = 85 \text{ }^\circ\text{C}$ )

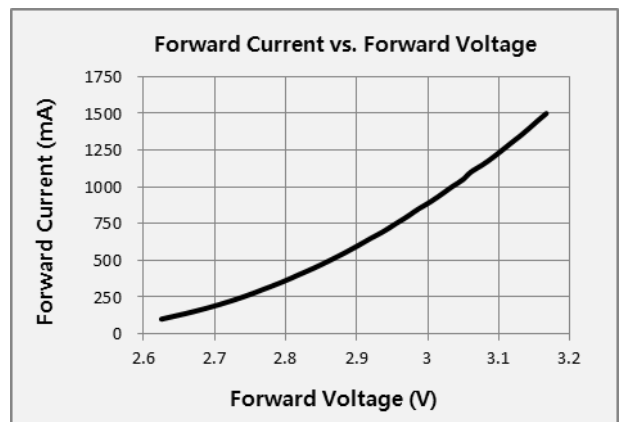
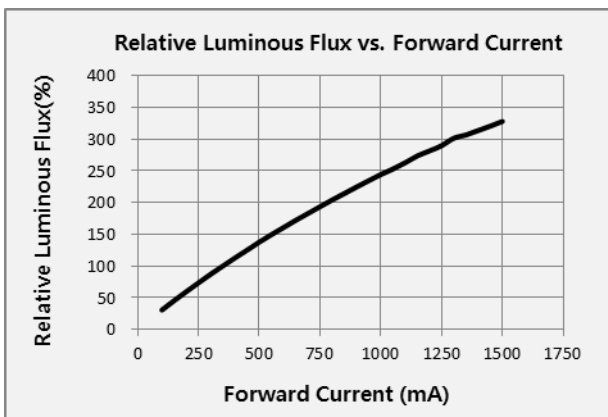

c) Temperature Characteristics ( $I_F = 350 \text{ mA}$ )

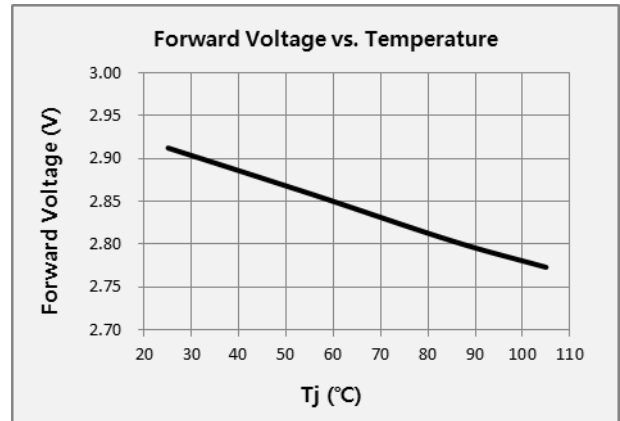
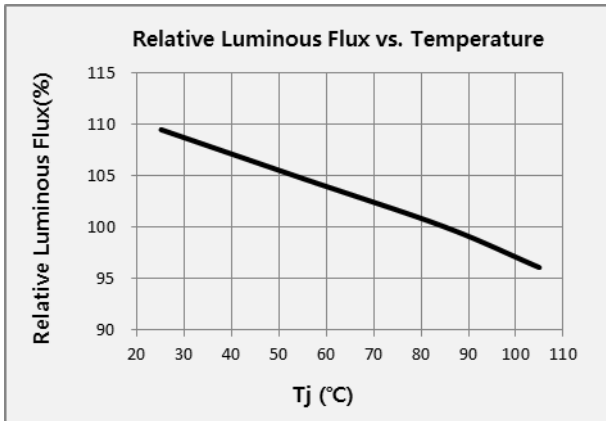

d) Color Shift Characteristics ( $I_F = 350 \text{ mA}$ ,  $T_j = 85 \text{ °C}$ )

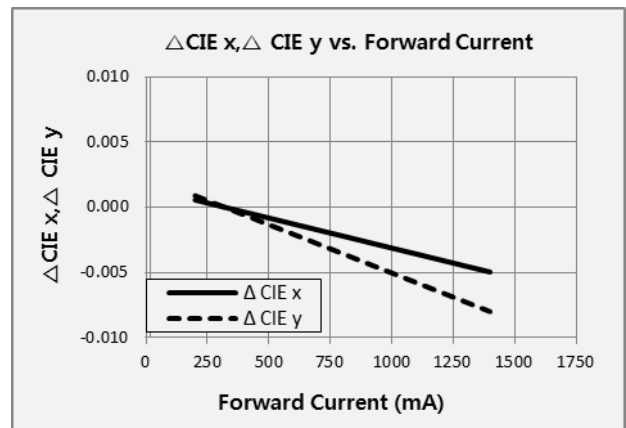
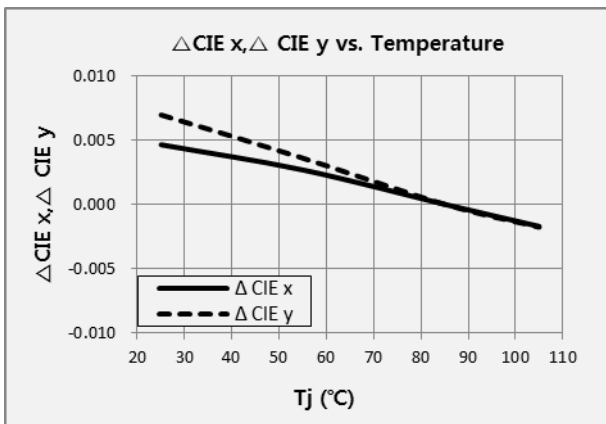

e) Derating Curve and Beam Angle Characteristics ( $I_F = 350 \text{ mA}$ ,  $T_j = 25 \text{ °C}$ )

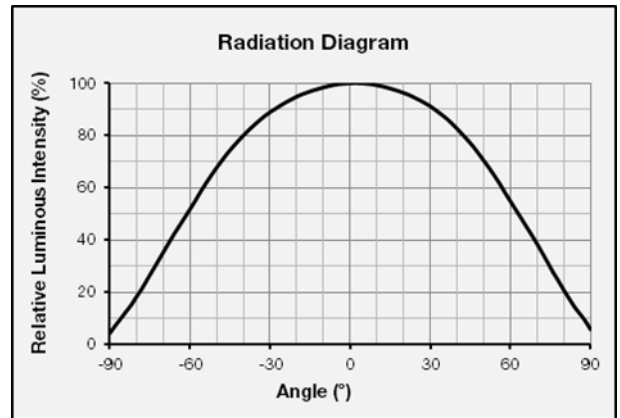
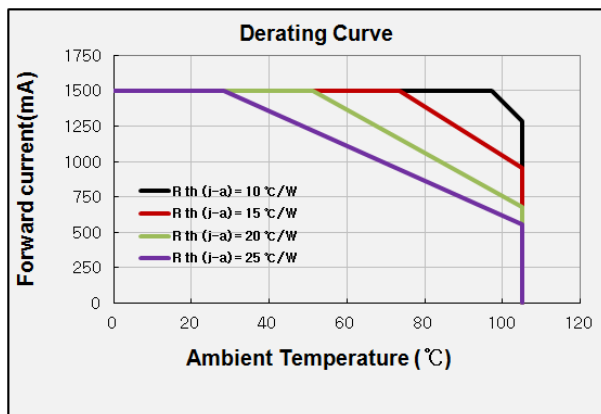

#### 4. Outline Drawing & Dimension

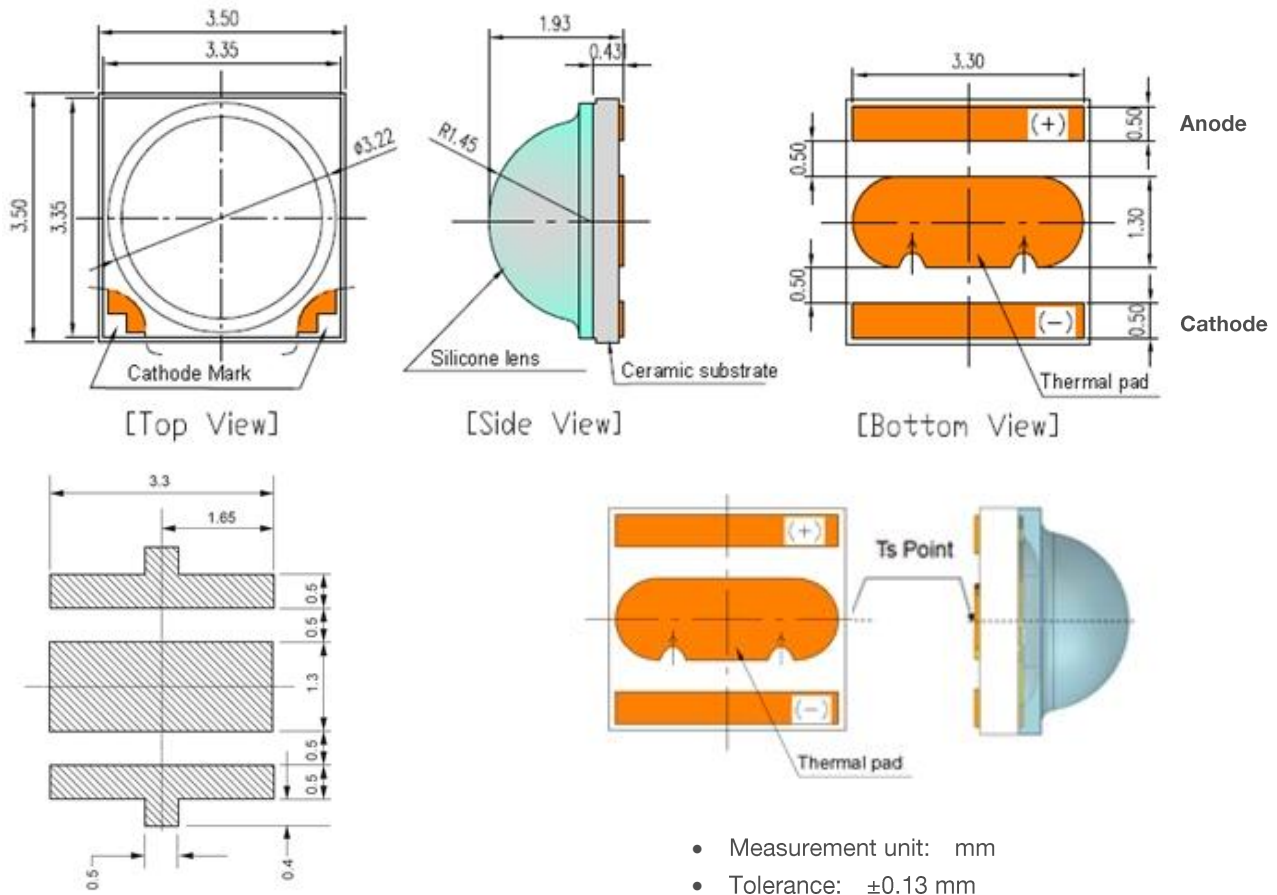

#### Recommended Soldering Pattern

##### Notes:

- 1) This LED has built-in ESD protection device(s) connected in parallel to LED chip(s).
- 2) The thermal pad is electrically isolated from the anode and cathode contact pads.
- 3)  $T_s$  point and measurement method:
  - ① Measure the nearest point to thermal pad as shown above. If necessary, remove PSR of PCB to reach  $T_s$  point.
  - ② All pads must be soldered to the PCB to dissipate heat properly, otherwise the LED can be damaged.

##### Precautions:

- 1) Pressure on the LEDs will influence to the reliability of the LEDs. Precautions should be taken to avoid strong pressure on the LEDs. Do not put stress on the LEDs during heating.
- 2) Re-soldering should not be done after the LEDs have been soldered. If re-soldering is unavoidable, LED's characteristics should be carefully checked before and after such repair.
- 3) Do not stack assembled PCBs together. Since materials of LEDs is soft, abrasion between two PCB assembled with LED might cause catastrophic failure of the LEDs.

## 5. Reliability Test Items & Conditions

### a) Test Items

| Test Item                           | Test Condition   | Test Hour / Cycle   | Sample Size |    |
|-------------------------------------|--|---|-------------|----|
| Room Temperature Life Test          | 25 °C, DC Derating $I_F$   | 1000 h  | 22          |    |
| High Temperature Life Test          | 85 °C, DC Derating $I_F$   | 1000 h  | 22          |    |
| High Temperature Humidity Life Test | 85 °C, 85 % RH, DC Derating $I_F$  | 1000 h  | 22          |    |
| Low Temperature Life Test           | -40 °C, DC Derating $I_F$  | 1000 h  | 22          |    |
| Damp Heat Cycling                   | -10 °C ↔ 25 °C 95 % RH ↔ 65 °C 95 % RH<br>DC Derating $I_F$ , 24 h / 1 cycle               | 10 cycles   | 11          |    |
| Powered Temperature Cycle           | -40 °C / 85 °C each 20 min, 100 min transfer<br>power on/off each 5 min, DC Derating $I_F$ | 100 cycles  | 11          |    |
| Temperature Cycling                 | -45 °C / 15 min ↔ 125 °C / 15 min<br>temperature change within 5 min                       | 500 cycles  | 100         |    |
| High Temperature Storage            | 120 °C   | 1000 h  | 11          |    |
| Low Temperature Storage             | -40 °C   | 1000 h  | 11          |    |
| ESD (HBM)                           |  | $R_1$ : 10 M $\Omega$<br>$R_2$ : 1.5 k $\Omega$<br>$C$ : 100 pF<br>$V$ : $\pm 8$ kV | 5 times     | 30 |
| ESD (MM)                            |  | $R_1$ : 10 M $\Omega$<br>$R_2$ : 0<br>$C$ : 200 pF<br>$V$ : $\pm 0.5$ kV            | 5 times     | 30 |
| Vibration Test                      | 20~2000~20 Hz, 200 m/s <sup>2</sup> , sweep 4 min<br>X, Y, Z 3 direction, each 1 cycle     | 4 cycles  | 11          |    |
| Mechanical Shock Test               | 1500 g, 0.5 ms<br>3 shocks each X-Y-Z axis   | 5 cycles  | 11          |    |

### b) Criteria for Judging the Damage

| Item            | Symbol   | Test Condition<br>( $T_j = 25$ °C) | Limit             |                   |
|-----------------|----------|------------------------------------|-------------------|-------------------|
|                 |          |                                    | Min.              | Max.              |
| Forward Voltage | $V_F$    | $I_F = 350$ mA                     | Init. Value * 0.9 | Init. Value * 1.1 |
| Luminous Flux   | $\Phi_v$ | $I_F = 350$ mA                     | Init. Value * 0.7 | Init. Value * 1.1 |

## 6. Soldering Conditions

### a) Reflow Conditions (Pb free)

Reflow frequency: 2 times max.

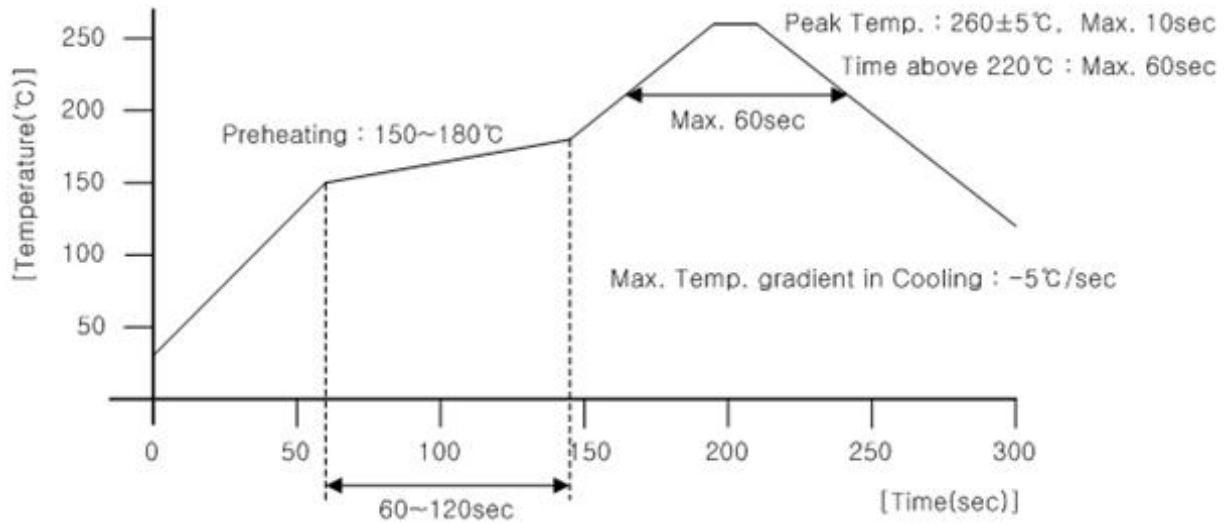

### b) Manual Soldering Conditions

Not more than 5 seconds @ max. 300 °C, under soldering iron.



## 7. Tape & Reel

### a) Taping Dimension

(unit: mm)

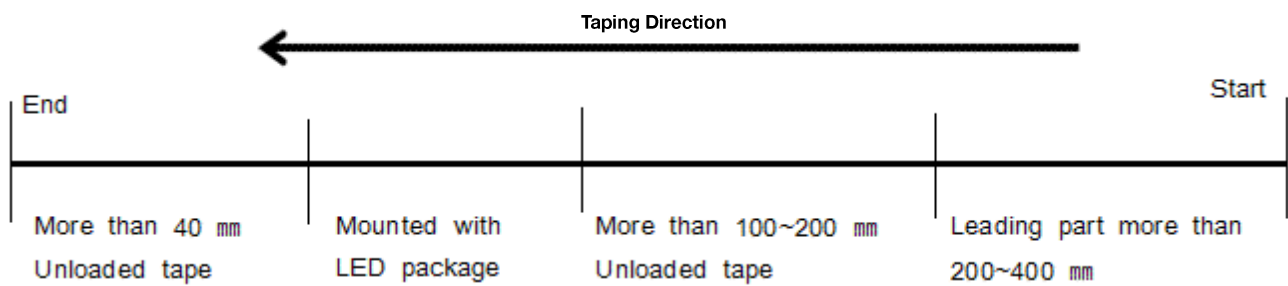
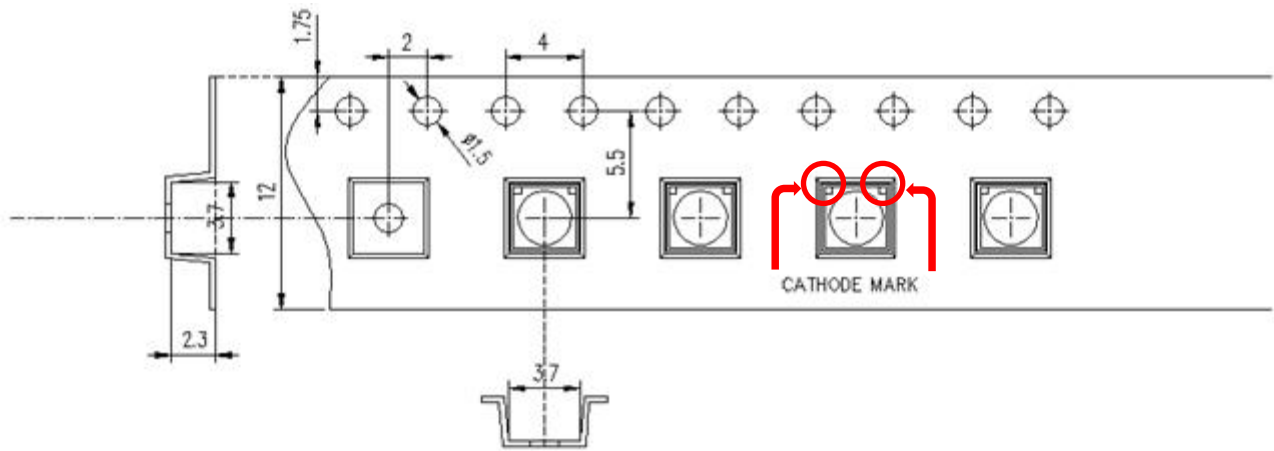

## b) Reel Dimension

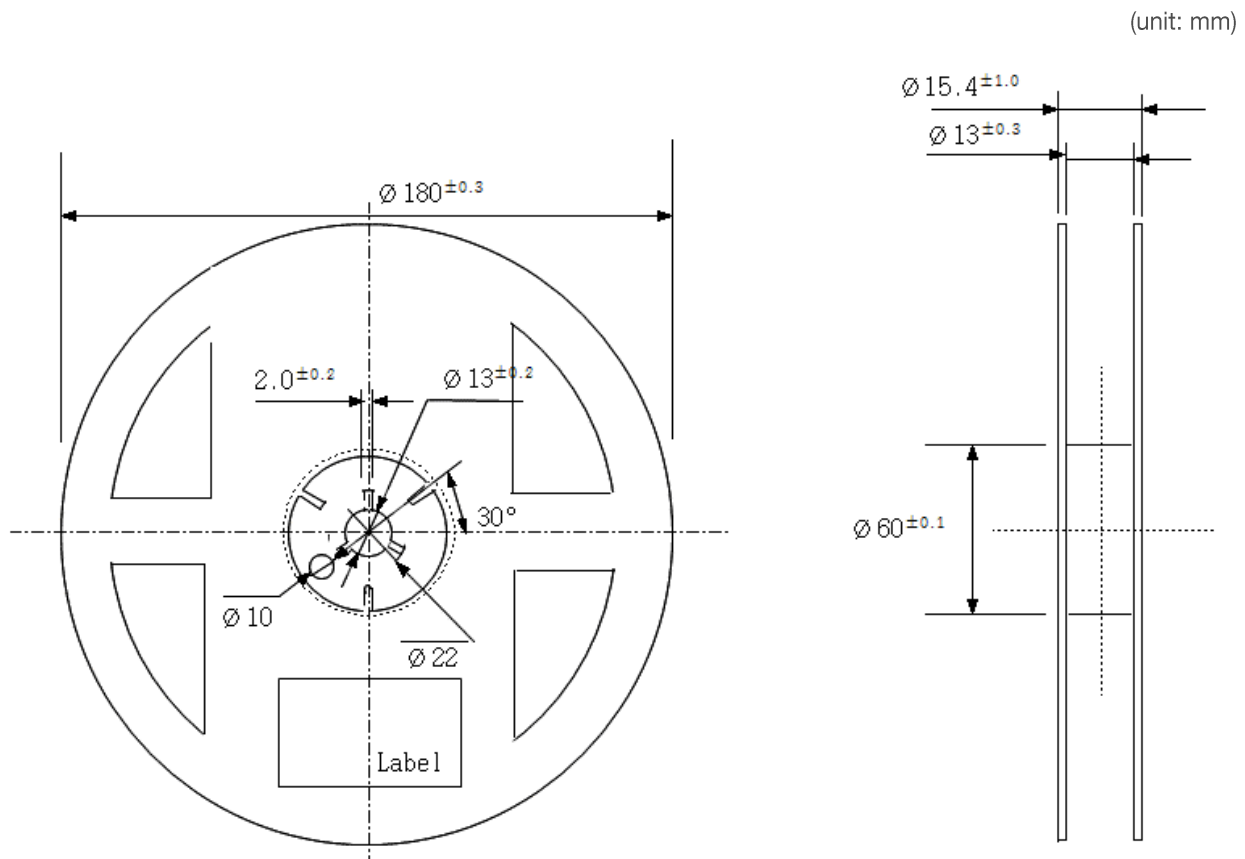
**Notes:**

- 1) Quantity: The quantity/reel is 1,000 pcs
- 2) Cumulative tolerance: Cumulative tolerance / 10 pitches is  $\pm 0.2$  mm
- 3) Adhesion strength of cover tape: Adhesion strength is 0.1-0.7 N when the cover tape is turned off from the carrier tape at  $10^\circ$  angle to the carrier tape
- 4) Packaging: P/N, Manufacturing data code no. and quantity are indicated on the aluminum packing bag

## 8. Label Structure

### a) Label Structure

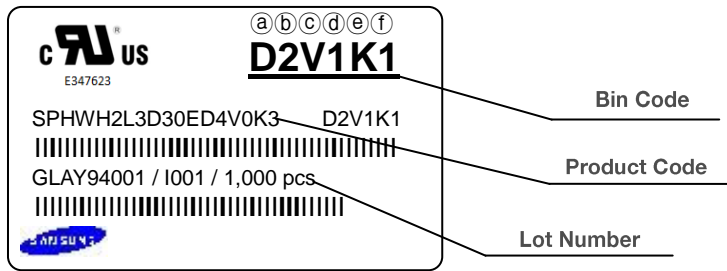

Note: Denoted bin code and product code above is only an example (see description on page 7)

Bin Code:

- ⒶⒷ: Forward Voltage bin (refer to page 15)
- ⒸⒹ: Chromaticity bin (refer to page 16-19)
- ⒺⒻ: Luminous Flux bin (refer to page 8-11)

### b) Lot Number

The lot number is composed of the following characters:

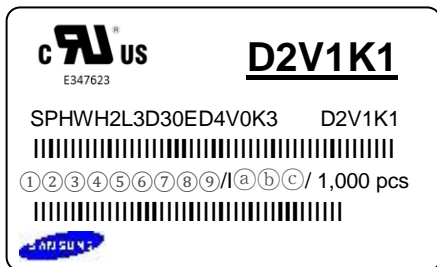

①②③④⑤⑥⑦⑧⑨ / I Ⓐ Ⓑ Ⓒ / 1,000 pcs

- ①, ② : Production site (G3: Shenzhen, China, G4: Guangzhou, China, GB : Nanchang, China)
- ③ : Product state (A: Normal, B: Bulk, C: First Production, R: Reproduction, S: Sample)
- ④ : Year (Y: 2014, Z: 2015, A: 2016, ...)
- ⑤ : Month (1~9, A, B, C)
- ⑥ : Day (1~9, A, B~V)
- ⑦⑧⑨ : Product serial number (001 ~ 999)
- Ⓐ Ⓑ Ⓒ : Reel number (001 ~ 999)

## 9. Packing Structure

### a) Packing Process

#### Reel

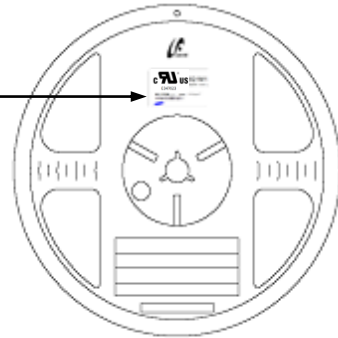
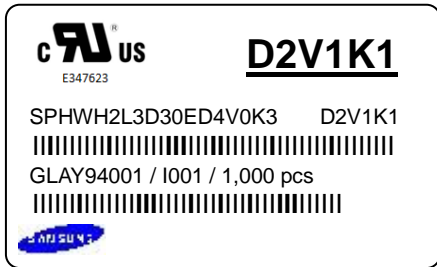

#### Aluminum Vinyl Packing Bag

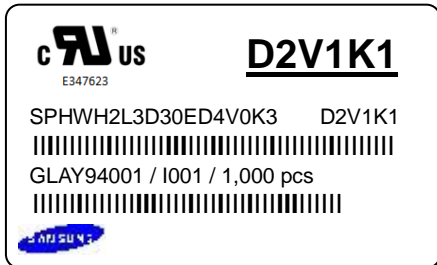

#### Outer Box

Material: Paper SW(B)

| Type       | Size (mm) |         |         | Note          |
|------------|-----------|---------|---------|---------------|
|            | (a)       | (b)     | (c)     |               |
| 7 inch (L) | 245 ± 5   | 220 ± 5 | 182 ± 5 | Up to 8 reels |
| 7 inch (S) | 245 ± 5   | 220 ± 5 | 86 ± 5  | Up to 4 reels |

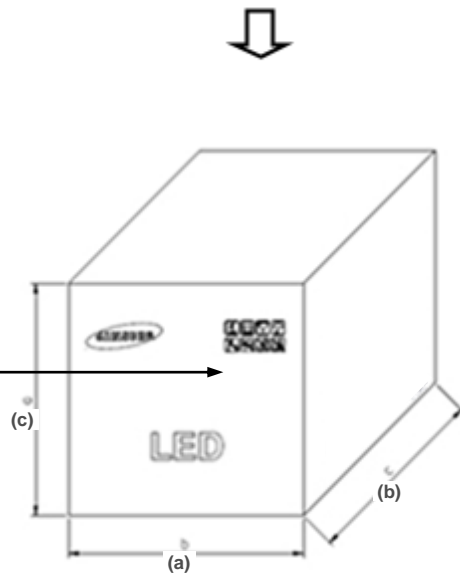
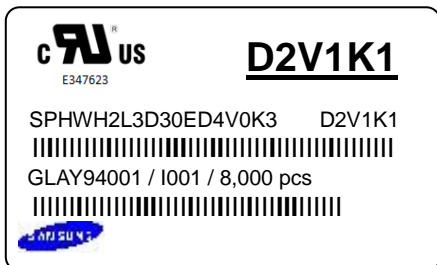

b) Aluminum Vinyl Packing Bag



**CAUTION**

This bag contains  
**MOISTURE SENSITIVE DEVICES**

**LEVEL**  
**2a**

**cUL** <sup>®</sup> **US**  
E347623

**D2V1K1**

SPHWH2L3D30ED4V0K3    D2V1K1

GLAY94001 / I001 / 1,000 pcs

**SAMSUNG**

1. Shelf life in sealed bag: 12 months at <40°C and <90% relative humidity (RH)

2. Peak package body temperature: 240 °C

3. After this bag is opened, devices that will be subjected to reflow solder or other high temperature processes must be:

- a. Mounted within 672 hours at factory conditions of equal to or less than 30°C /60% RH, or
- b. Stored at <10% RH

4. Devices require bake, before mounting, if:

- a. Humidity Indicator Card is >65% when read at 23±5°C, or
- b. 2a is not met.

5. If baking is required, devices must be baked for 1 hours at 60±5°C

Note: If device containers cannot be subjected to high temperature or shorter bake times are desired, reference IPC/JEDEC J-STD-033 for bake procedure.

Bag seal due date: \_\_\_\_\_  
(if blank, see code label)

Note: Level and body temperature by IPC/JEDEC J-STD-020



**LEAD-FREE**



**ATTENTION**  
OBSERVE PRECAUTIONS FOR HANDLING ELECTROSTATIC SENSITIVE DEVICES



**OTHER**

**주의 사항**

이 알루미늄 지퍼 백은 습기 및 정전기로부터 제품을 보호하기 위하여 제작되었습니다. 개봉 후에는 즉시 솔더 작업을 실시하는 것을 권장합니다.

습기 및 정전기로부터 제품을 보호 하기 위해서 개봉 후 사용하지 않는 자재는 본 팩에 넣어 보관 하시기 바랍니다. 사용하지 않는 자재를 본 팩에 넣을 때는 반드시 동봉된 드라이 팩과 함께 넣고 지퍼부분을 완전하게 밀봉하여 주시기 바랍니다.

**Important**

This Al Zipper bag is designed to protect the enclosed products from moisture and ESD. Once opened, the products should be soldered onto the printed circuit board immediately. When not in use, please do not leave the products unprotected by the Al Zipper Bag. To repack unused products., please ensure the zip-lock is completely sealed with the dry pack left inside.

c) Silica Gel & Humidity Indicator Card inside Aluminum Vinyl Bag



DESICCANT  
**SILICA**  
DO NOT  
GEL

**HUMISAFE™**

**HUMIDITY INDICATOR COBALT-FREE**

10%



20%



30%



40%



50%



60%



READ AT TOP OF GREEN COLOR CHANGE BETWEEN YELLOW AND GREEN

Warning if Green Change Desiccant

GP&E Co., Ltd.  
6CF-60NS

## 10. Precautions in Handling & Use

- 1) For over-current protection, users are recommended to apply resistors connected in series with the LEDs to mitigate sudden change of the forward current caused by shift of forward voltage.
- 2) This device should not be used in any type of fluid such as water, oil, organic solvent, etc. When cleaning is required, IPA is recommended as the cleaning agent. Some solvent-based cleaning agent may damage the silicone resins used in the device.
- 3) When the device is in operation, the forward current should be carefully determined considering the maximum ambient temperature and corresponding junction temperature.
- 4) LEDs must be stored in a clean environment. If the LEDs are to be stored for three months or more after being shipped from Samsung, they should be packed with a nitrogen-filled container (shelf life of sealed bags is 12 months at temperature 0~40 °C, 0~90 % RH).
- 5) After storage bag is opened, device subjected to soldering, solder reflow, or other high temperature processes must be:
  - a. Mounted within 672 hours (28 days) at an assembly line with a condition of no more than 30 °C / 60 % RH, or
  - b. Stored at <10 % RH
- 6) Repack unused devices with anti-moisture packing, fold to close any opening and then store in a dry place.
- 7) Devices require baking before mounting, if humidity card reading is >60 % at 23 ± 5 °C.
- 8) Devices must be baked for 1 hour at 60 ± 5 °C, if baking is required.
- 9) The LEDs are sensitive to the static electricity and surge current. It is recommended to use a wrist band or anti-electrostatic glove when handling the LEDs. If voltage exceeding the absolute maximum rating is applied to LEDs, it may cause damage or even destruction to LED devices. Damaged LEDs may show some unusual characteristics such as increase in leakage current, lowered turn-on voltage, or abnormal lighting of LEDs at low current.
- 10) VOCs (Volatile Organic Compounds) can be generated from adhesives, flux, hardener or organic additives used in luminaires (fixtures). Transparent LED silicone encapsulant is permeable to those chemicals and they may lead to a discoloration of encapsulant when they exposed to heat or light. This phenomenon can cause a significant loss of light emitted (output) from the luminaires. In order to prevent these problems, we recommend users to know the physical properties of materials used in luminaires and they must be carefully selected.

# Legal and additional information.

## [About Samsung Electronics Co., Ltd.](#)

Samsung Electronics Co., Ltd. inspires the world and shapes the future with transformative ideas and technologies, redefining the worlds of TVs, smartphones, wearable devices, tablets, cameras, digital appliances, printers, medical equipment, network systems and semiconductors.

We are also leading in the Internet of Things space through, among others, our Digital Health and Smart Home initiatives. We employ 307,000 people across 84 countries. To discover more, please visit our official website at [www.samsung.com](http://www.samsung.com) and our official blog at [global.samsungtomorrow.com](http://global.samsungtomorrow.com).

Copyright © 2016 Samsung Electronics Co., Ltd. All rights reserved.

Samsung is a registered trademark of Samsung Electronics Co., Ltd.

Specifications and designs are subject to change without notice. Non-metric weights and measurements are approximate. All data were deemed correct at time of creation. Samsung is not liable for errors or omissions. All brand, product, service names and logos are trademarks and/or registered trademarks of their respective owners and are hereby recognized and acknowledged.

Samsung Electronics Co., Ltd.

1, Samsung ro

Giheung-gu

Yongin-si, Gyeonggi-do, 17113

KOREA

[www.samsungled.com](http://www.samsungled.com)

