



# LED-25W Series– Fixed Output and Dimmable Switch Mode LED Drivers Constant Current & Constant Voltage with Isolation Black Magic Thermal Advantage™ Plastic Housing

## Electrical Specifications

Input Voltage Range:	100-277 Vac Nom. (90-305 V Min/Max)
Input Over-Voltage:	Can endure 320Vac for 48 Hrs, 350Vac for 2 Hrs
Frequency:	50/60 Hz Nom. (47-63 Hz Min/Max)
Power Factor:	>0.90 @ full load, 100V through 277V
Inrush Current:	<15.0 Amps max @ 230 Vac, cold start 25°C
Input Current:	0.25 Amps max @ 120 Vac
Maximum Power:	25W
Current Accuracy:	± 1% Over input line variation
Load Regulation:	± 3%
THD:	≤ 20% @ full load
Turn-On Delay:	<1.0 Sec. @ full output; 1-4 Sec. @ full dim
Leakage Current:	400 µA Typical
Hold Up Time:	Half Cycle
Protection:	Output Over-Voltage, Output Over-Current, and Output Short Circuit Protection with Auto Recovery

## Environmental Specifications

Minimum Starting Temp:	-30°C
Maximum Case Temp.	90°C
Storage Temperature:	-40°C to +85°C
Humidity:	5% to 95%
Cooling:	Convection
Vibration Frequency:	5 to 55 Hz/2g, 30 minutes
Sound Rating:	Class A
MTBF:	482,000 Hours at full load and 40°C ambient conditions per MIL-217F Notice 2
EMC:	FCC 47CFR Part 15 Class B compliant



- Total Power: 25 Watts
- Input Voltage: 100-277 Vac Nom.
- UL Dry & Damp Location Rated
- High Power Factor
- UL8750 and Class 2 Compliant, as noted
- UL Sign Components Manual (S.A.M. Models)

### Constant Current

Model Number	Output Current (mA ±3%)	Output Voltage Range (Vdc)	Max. Output Power (W)	Typical Efficiency
LED25W-72-C0350-XX	350	24-72	25	86%
LED25W-40-C0350-XX	350	13-40	14	84%
LED25W-28-C0350-XX	350	10-28	9.8	83%
LED25W-62-C0400-XX	400	21-62	24.8	85%
LED25W-56-C0450-XX	450	19-56	25	84%
LED25W-40-C0500-XX	500	13-40	20	84%
LED25W-40-C0620-XX	620	13-40	24.8	84%
LED25W-36-C0700-XX	700	12-36	25	84%
LED25W-28-C0850-XX	850	10-28	23.8	83%
LED25W-24-C1040-XX	1040	8-24	25	83%
LED25W-20-C1250-XX	1250	7-20	25	83%
LED25W-18-C1400-XX	1400	6-18	25	82%
LED25W-16-C1560-XX	1560	6-16	25	82%
LED25W-14-C1750-XX	1750	5-14	24.5	82%
LED25W-12-C2080-XX	2080	4-12	25	81%

-XX indicates dimming options are available. See options at left. Blank = fixed current output

### Constant Voltage

Model Number	Output Voltage (Vdc ±5%)	Output Current Range (mA)	Max. Output Power (W)	Typical Efficiency
LED25W-12	12	520-2080	25	81%
LED25W-14	14	438-1750	24.5	82%
LED25W-16	16	390-1560	25	82%
LED25W-18	18	360-1400	25	82%
LED25W-20	20	313-1250	25	83%
LED25W-24	24	260-1040	25	83%
LED25W-28	28	213-850	23.8	83%
LED25W-36	36	175-700	25	84%
LED25W-40	40	155-620	24.8	84%
LED25W-56	56	113-450	25	84%
LED25W-62	62	100-400	24.8	85%
LED25W-72	72	88-350	25	86%

• Indicates S.A.M.

### Ordering Options:

- D: 0-10V & Resistance dimmable version comes with an extra two wires +Purple/-Gray on the output side. "-D" 0-10V Dimming is compatible with most quality 0-10V wall dimmers. See page 3 for additional specifications.



### Note:

LED drivers are designed and intended to operate LED loads only. Non-LED loading may be outside the specified design limits of our LED drivers, and therefore cannot be covered by any warranty. If you desire to use our LED drivers to operate non-LED loads please contact us to discuss compatibility.

Specifications subject to change without notice.

Class 2: US/Canada

Rev 10-13-16



## Dimensions - IN [mm]

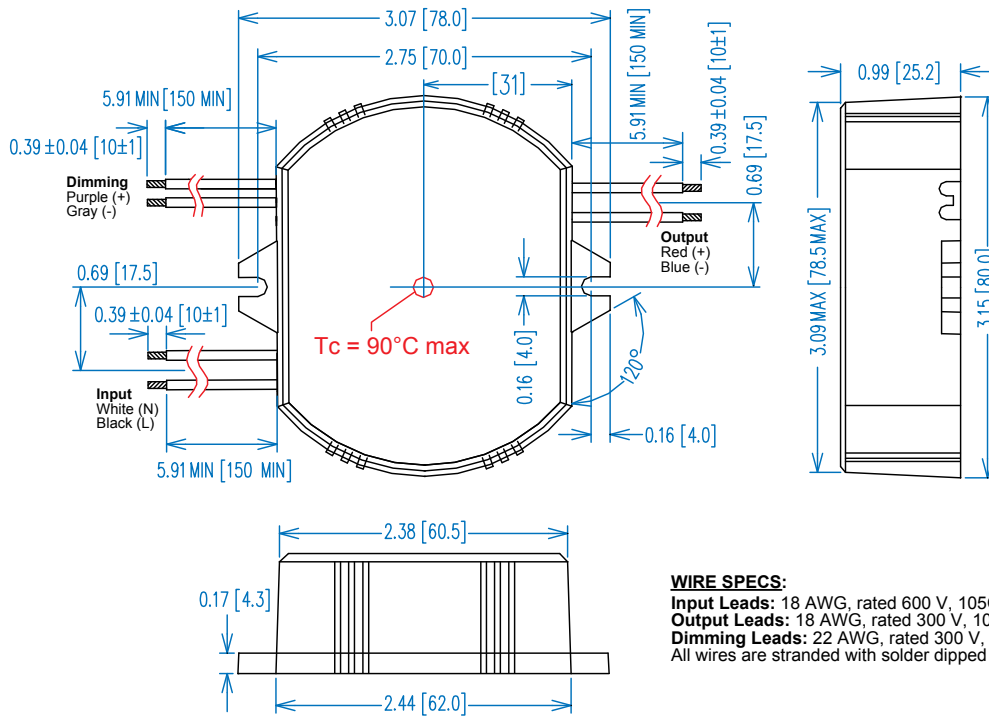

### WIRE SPECS:

**Input Leads:** 18 AWG, rated 600 V, 105C, min.  
**Output Leads:** 18 AWG, rated 300 V, 105C, min.  
**Dimming Leads:** 22 AWG, rated 300 V, 105C.  
 All wires are stranded with solder dipped ends.

### Power Factor / Load

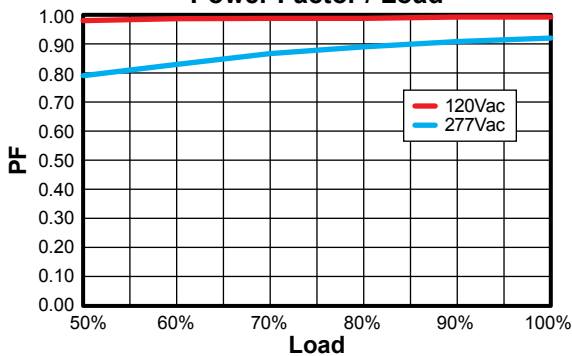

### THD / Load

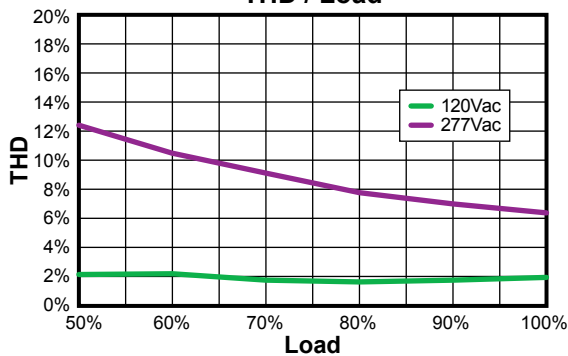

### Typical Efficiency / Load

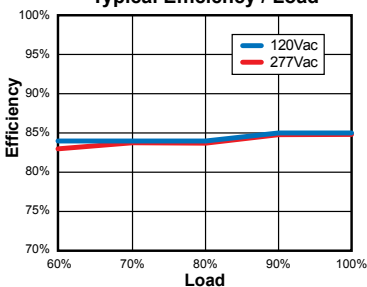

### Lifetime / Case Temperature

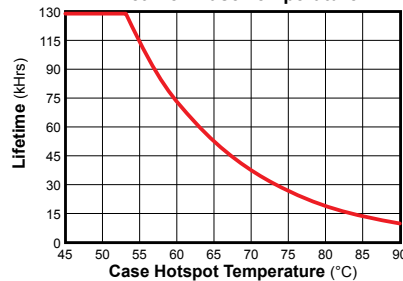

Safety Cert.	Standard
UL/CUL	UL8750
CSA	22.2
CE	EN61347
EMC Standard	Notes
EN61000-3-2	
EN61000-3-3	Class C
FCC, 47CFR Part 15	Class B
EN6100-4-5	2KV L-N, 8/20 μsec Surge Protection

## UL Conditions of Acceptability

See website for additional information

### Note:

The area under the life-temperature curve represents where the driver has highly reliable operation within specification. Driver performance may drift out of published specifications as the hours of operation exceed the curve at a given temperature. Higher operating temperatures increase the chances of a failure to function. Other electrical, mechanical and environmental factors affect driver lifetime but are not represented in this calculation.

**“-D” Option: 0-10VDC and Resistance Dimming**

Parameters	Minimum	Typical	Maximum
Source Current out of 0-10V Purple Wire	0 mA	—	2 mA
Absolute Voltage Range on 0-10V (+) Purple Wire	-2.0 V	—	+15 V

**Typical Dimming Circuit**

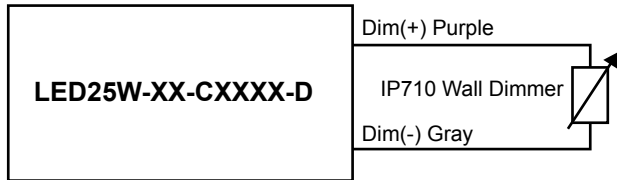

(Dimmer must be current-sink type control)

**Output Current / 0-10VDC Dimming Control Voltage**

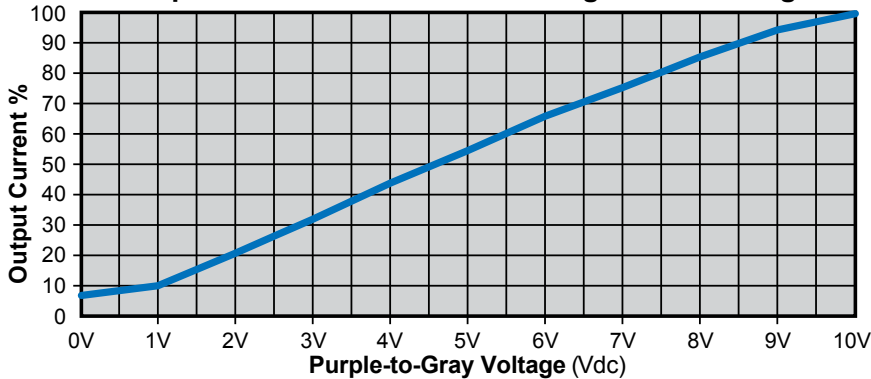

**Notes:**

1. 0-10V dimmable version comes with an extra two wires +Purple/-Gray on the output side.
2. Compatible with most 0-10V dimmers. Recommended dimmer is Leviton IP710 or equivalent
3. 0-10V dimmable version is not intended to dim below about 5% @ 0V or 10% @ 1.0V
4. 0-10V dimmable version output will be 100% with Purple/Gray open and minimum with Purple/Gray Shorted.