

Core **E22/6/16 + PLT22/16/2.5**

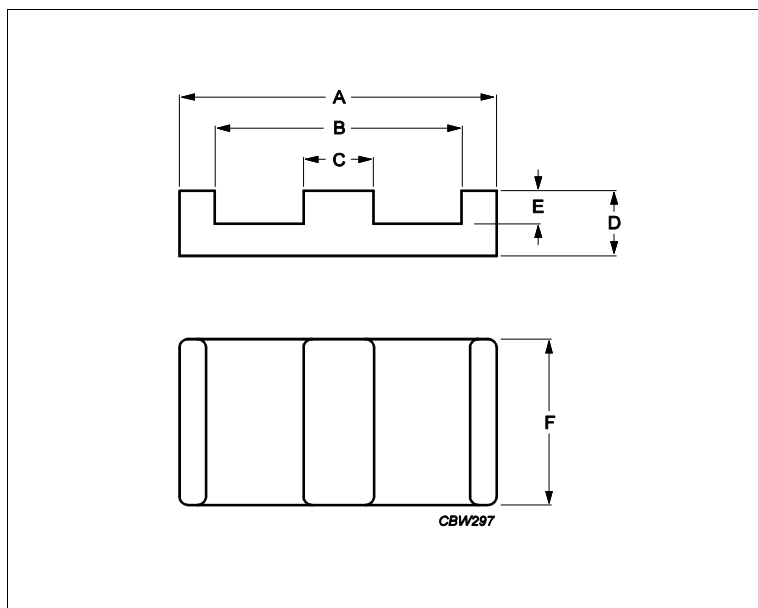

Effective parameters			
	Parameter	Value	Unit
$\Sigma(I/A)$	core factor (C1)	0.332	mm ⁻¹
Ve	effective volume	2040	mm ³
Le	effective length	26.1	mm
Ae	effective area	78.5	mm ²
Amin	minimum area	78.5	mm ²
m	E22/6/16	≈ 6.5	g/pcs
m	PLT22/16/2.5	≈ 4	g/pcs

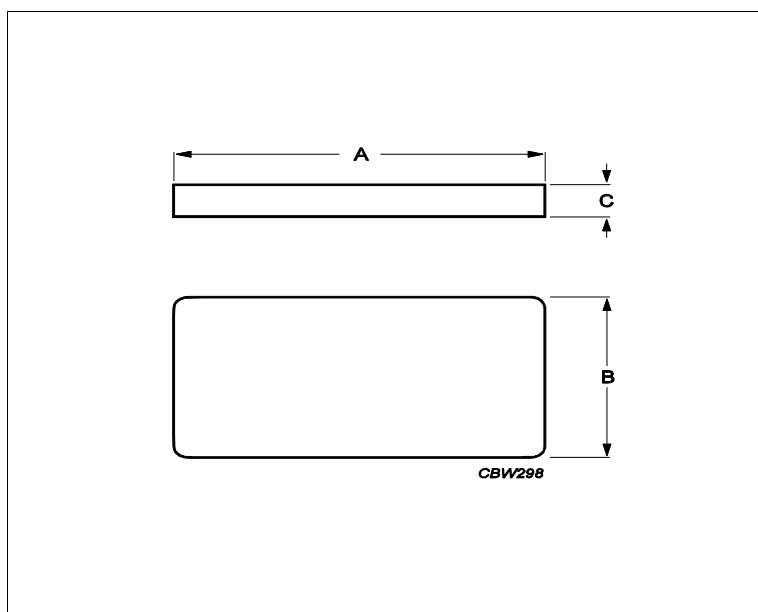

Dimensions for product: E22/6/16						
	Nom	Tol +	Tol -	Max	Min	Unit
A	21.80	0.40	0.40	22.20	21.40	mm
B	16.80	0.40	0.40	17.20	16.40	mm
C	5.00	0.10	0.10	5.10	4.90	mm
D	5.70	0.10	0.10	5.80	5.60	mm
E	3.20	0.10	0.10	3.30	3.10	mm
F	15.80	0.30	0.30	16.10	15.50	mm
Dimensions for product: PLT22/16/2.5						
	Nom	Tol +	Tol -	Max	Min	Unit
A	21.80	0.40	0.40	22.20	21.40	mm
B	15.80	0.30	0.30	16.10	15.50	mm

Core **E22/6/16 + PLT22/16/2.5**

Dimensions for product: PLT22/16/2.5						
	Nom	Tol +	Tol -	Max	Min	Unit
C	2.50	0.05	0.05	2.55	2.45	mm

Inductance factor					
Material	Value	Tol +	Tol -	Unit	
3C92	4400	25%	25%	nH/turns ²	
3C95	7360	25%	25%	nH/turns ²	
3C96	5450	25%	25%	nH/turns ²	
3C97	7360	25%	25%	nH/turns ²	
3F36	3800	25%	25%	nH/turns ²	
3F46	2400	25%	25%	nH/turns ²	
4F1	300	25%	25%	nH/turns ²	

Power loss: 3C92				
Measuring conditions			Max	Unit
100 kHz	200 mT	100 °C	1.000	W/set

Power loss: 3C95				
Measuring conditions			Max	Unit
100 kHz	200 mT	100 °C	0.980	W/set
100 kHz	200 mT	25 °C	1.100	W/set

Power loss: 3C96				
Measuring conditions			Max	Unit
100 kHz	200 mT	100 °C	0.920	W/set
400 kHz	50 mT	100 °C	0.370	W/set

Power loss: 3C97				
Measuring conditions			Max	Unit
100 kHz	200 mT	60 °C	1.000	W/set
100 kHz	200 mT	120 °C	0.980	W/set
100 kHz	200 mT	140 °C	1.200	W/set

Power loss: 3F36				
Measuring conditions			Max	Unit
500 kHz	50 mT	100 °C	0.310	W/set
500 kHz	100 mT	100 °C	2.300	W/set

Power loss: 3F46				
Measuring conditions			Max	Unit
1000 kHz	50 mT	100 °C	0.820	W/set
3000 kHz	10 mT	100 °C	0.340	W/set

Bsat					
Measuring conditions			Material	Min	Unit
25 kHz	250 A/m	100 °C	3C92	370	mT
25 kHz	250 A/m	100 °C	3C95	330	mT

Core **E22/6/16 + PLT22/16/2.5**

25 kHz	250 A/m	100 °C	3C96	340	mT
25 kHz	250 A/m	100 °C	3C97	330	mT
25 kHz	250 A/m	100 °C	3F36	340	mT
25 kHz	250 A/m	100 °C	3F46	330	mT