

FEATURES

- Converter and Evaluation Development (EVAL-CED1Z) compatibility**
- Versatile analog signal conditioning circuitry**
- On-board reference, clock oscillator and buffers**
- Buffered 16 bit parallel outputs**
- Buffered LVDS serial interface**
- Ideal for DSP and data acquisition card interfaces**
- PC software for control and data analysis**

GENERAL DESCRIPTION

The EVAL-AD7625_26EDZ is an evaluation board for the 32 lead AD7625 and AD7626 16-bit PulSAR® analog to digital converters (ADCs). These low power, ADCs offer very high performance of up to 6MSPS (AD7625) and 10MSPS (AD7626) throughput rates with a flexible parallel interface on the 96-pin interface. The evaluation board is designed to demonstrate the ADC's performance and to provide an easy to understand

interface for a variety of system applications. A full description of the AD7625 and AD7626 available in the Analog Devices data sheets and should be consulted when utilizing this evaluation board.

The evaluation board is ideal for use with Analog Devices Converter and Evaluation Development EVAL-CED1Z, (CED). The design offers the flexibility of applying external control signals and is capable of generating conversion results on parallel 16-bit wide buffered outputs.

On-board components include a high precision buffered band gap 4.096V reference, (ADR434), reference buffers (AD8031), a signal conditioning circuit with two op-amps (ADA4899-1), differential driver (ADA4932-1) and an FPGA for deserializing the LVDS serial conversion results.

The EVAL-AD7625_26EDZ interfaces to the CED1Z capture board with a 96-pin DIN connector. SMB connectors are provided for the low noise analog signal source...

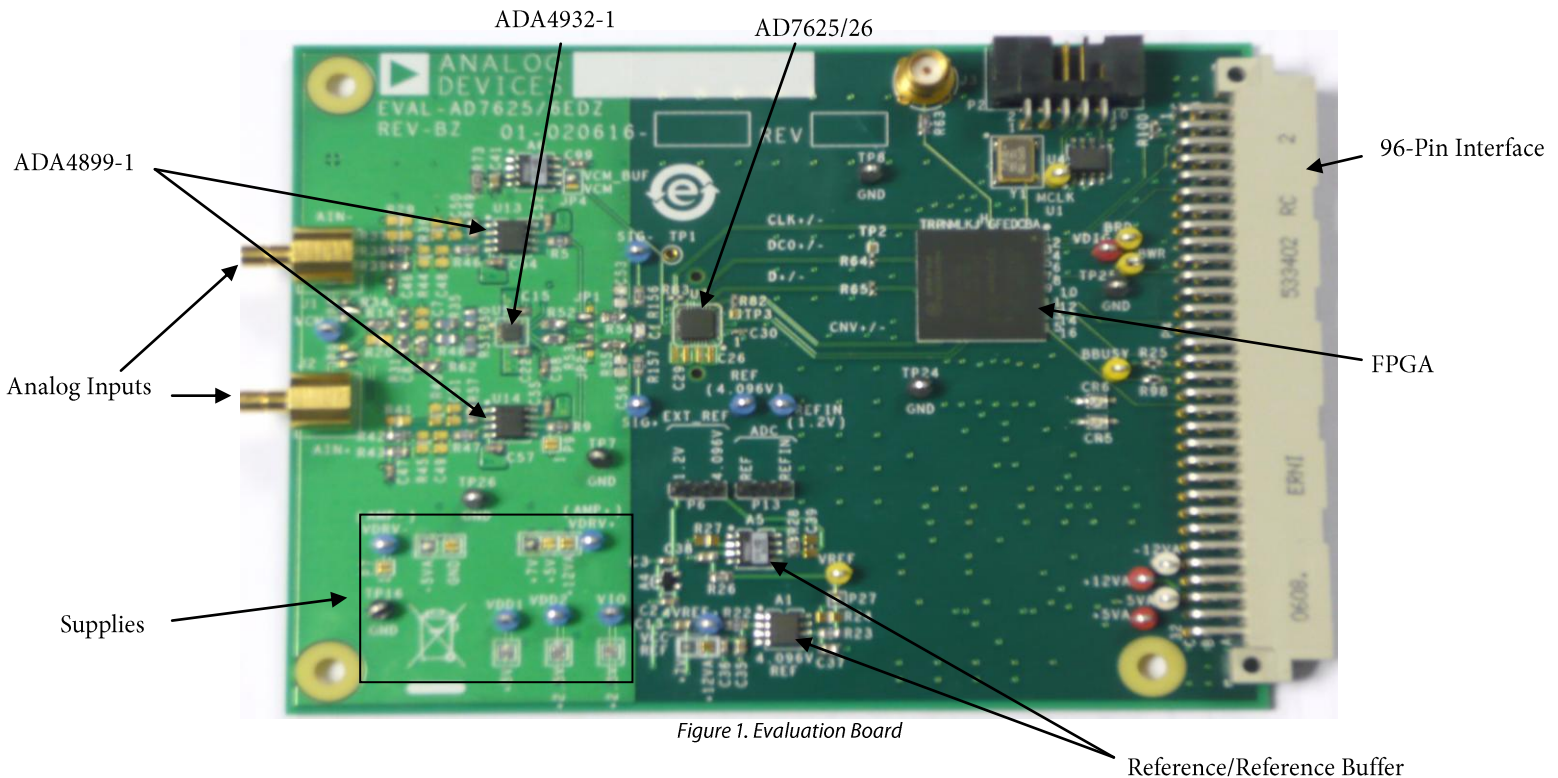

Figure 1. Evaluation Board

Rev. PrC

Information furnished by Analog Devices is believed to be accurate and reliable. However, no responsibility is assumed by Analog Devices for its use, nor for any infringements of patents or other rights of third parties that may result from its use. Specifications subject to change without notice. No license is granted by implication or otherwise under any patent or patent rights of Analog Devices. Trademarks and registered trademarks are the property of their respective owners.

TABLE OF CONTENTS

FEATURES..... 1

GENERAL DESCRIPTION 1

 Overview..... 3

 Conversion Control..... 3

 Analog Inputs..... 3

 Reference 3

 Power Supplies and Grounding..... 3

 Schematics/PCB Layout..... 4

 Hardware Setup 4

Software Installation5

Running the Software.....6

DC Testing - Histogram6

AC Testing.....6

Decimated AC Testing.....6

Bill Of Materials..... 22

Ordering Guide 25

LIST OF FIGURES

Figure 1. Evaluation Board..... 1

Figure 2. Schematic, Power Supplies..... 9

Figure 3. Schematic, Reference 10

Figure 4. Schematic, Analog..... 11

Figure 5. Schematic, ADC 12

Figure 6. Schematic, 96-Pin Interface..... 13

Figure 7. Schematic, FPGA 14

Figure 8. Setup Screen..... 15

Figure 9. Context Help..... 16

Figure 10. Histogram Screen..... 17

Figure 11. Summary 18

Figure 12. FFT Spectrum..... 19

Figure 13. Oscilloscope..... 20

Figure 14. Decimated FFT..... 21

LIST OF TABLES

Table 1. Jumper Description..... 8

Table 2. Test Points (In order by type of signal) 8

Table 3. Bill of Materials for the Connectors8

OVERVIEW

Figure 1 shows the EVAL-AD7625_26EDZ evaluation board. The on board FPGA, U1, provides the necessary control signals for conversion and deserializes the LVDS serial data as the CED1Z board uses a parallel interface. The evaluation board is a flexible design that enables the user to choose among many different board configurations, analog signal conditioning, reference, and different modes of conversion data.

CONVERSION CONTROL

Conversion start (CNV+/-) controls the sample rate of the ADC and is the only input needed for conversion; all ADC timing is generated internally. Presently the evaluation board hardware and software are only supported for on-board generated CNV.

The on board FPGA does a number of digital functions, one of them being the deserializing the LVDS serial conversion results as the CED1Z data capture boards uses a 16-bit parallel interface. If desired, the deserialized data can be monitored on the 96-pin edge connector P4, BD15:0]. The CED1Z uses a buffered busy signal BBUSY as the general interrupt for data transfer and this can be monitored at the test point marked "BBUSY".

The AD7625/AD7626 use two modes of data transfer. (Refer to the datasheets for more details). One is a self clocked mode in which the data, D+/- is preceded by a zero and then a 2-bit header. The other mode is the "Echoed-Clock" interface in which the clock is echoed back out in phase with the data (3 LVDS pairs). The evaluation board and software currently supports the echoed-clock interface mode.

ANALOG INPUTS

The analog input amplifier circuitry (U13, U14, U5 and discrete components) allows configuration changes such as positive or negative gain, input range scaling, filtering, addition of a DC component, use of different op-amp and supplies, and single ended to differential conversion.

The analog input amplifiers (U13 and U14) are set as unity gain buffers at the factory. The board is defaulted to use the ADA4899-1 devices as the driver amplifiers through the solder links JP9, JP6, JP1 and JP2.

The supplies for the amplifiers are selectable with solder pads and are set for the +7V/-5V ranges.

The default configuration sets both U13 and U14 at mid-scale generated from ADC7625/AD7626 on chip REF/2 output – which may be buffered or routed (JP4 selects the route) directly to the amplifiers.

For dynamic performance, an FFT test can be done by applying a very low distortion AC source. Since these ADCs are differential inputs, it is necessary to provide a fully-differential source. For low frequency testing, the Audio Precision sources can be used directly as the outputs on these are isolated. Set the outputs for balanced and floating. Different sources can be used however most are single ended and use a fixed output resistance. Since the evaluation board uses the amplifiers in unity gain, the non inverting input has a the common mode input with a series 590 ohm resistor and this needs to be taken into account when directly connecting a source.

The default setting on the analog front end routes the differential analog inputs from the connectors J1 and J2 to the 2xADA4899-1 amplifiers U13 and U14. An alternative option is to use the ADA4932-1 – typically, where the analog input frequency is of a higher value > 2MHz. The ADA4932-1 has a default setting of a single ended to differential driver with the single ended input applied to J1 it is routed to the input of the ADA4932-1 by setting JP6, JP1, JP2, and JP9 to the correct settings. Changing the settings on these solder links will allow the user to implement a single ended to differential conversion circuit using the U5 (ADA4932-1). This single ended to differential circuit is configured to 50-Ohm termination followed by a unity gain (inverting differential amplifier) stage around the ADA4932-1. With 50-Ohm source output impedance, this will give a gain of 0.5.

The ADA4932-1 is set up and balanced to give excellent noise and distortion performance from the AD7626. Please consult the ADA4932-1 datasheet to optimize the circuit for your application.

REFERENCE

The AD7625/AD7626 have an internal 4.096V reference along with an internal buffer useful for using an external reference or can use directly an external 4.096V reference. The evaluation board can be configured to use any of these references. For using the internal ADC reference, leave P13 open (default). To use the ADR434, set P13 to connecting the centre pin marked "REF" and P6 to the "4.096V" option. (The 4.096V output of the ADR434 is buffered by an AD8031 in a unity gain configuration).

For using the internal reference buffer on the AD7625/AD7626 REFIN pin, set TP13 to the "REFIN" option and set P6 to the "1.2V" setting. The ADR280 (A4) sets the 1.2V reference voltage applied to REFIN, prior to the internal buffer in the AD7625/AD7626 device, which creates the required internal 4.096V.

POWER SUPPLIES AND GROUNDING

The ground plane of the evaluation board is separated into two sections: a plane for the digital interface circuitry and an analog plane for the analog input and external reference circuitry. To attain high resolution performance, the board was designed to ensure that all digital ground return paths do not cross the analog ground return paths by connecting the planes together directly under the converter. Power is supplied to the board through P4 when using with the EVAL-CED1Z.

SCHEMATICS/PCB LAYOUT

The EVAL-AD7625_26EDZ is a 4-layer board carefully laid out and tested to demonstrate the specific high accuracy performance of the AD7625 and AD7626. Figure 2 to Figure 1 show the schematics of the evaluation board.

HARDWARE SETUP

- EVAL-AD7625_26EDZ evaluation board
- EVAL-CED1Z
- Enclosed World compatible 7V DC supply
- Enclosed USB to mini USB cable

Proceed to the Software Installation section to install the software. **Note: The EVAL-CED1Z board must not be connected to the PC's USB port until the Software is installed.** The 7V DC supply can be connected however to check the board has power (green LED lit).

SOFTWARE INSTALLATION

This section covers software installation. It is recommended to close all Windows’ applications prior to installing the software.

System Requirements

- PC operating Windows XP.
- USB 2.0 (for CED board)
- Administrator privileges

CD-ROM –Navigate Software\CED Version x.x, double click on *setup.exe* and follow the instructions on the screen. If another version of Analog Devices PulSAR Evaluation Software is present, it may be necessary to remove this. To remove, click on the Windows “Start” button, select “Control Panel” and “Add or Remove Programs”. When the list populates, navigate to Analog Devices High Resolution sampling ADC’s Evaluation Software or PulSAR Evaluation Software and select Remove.

Website Download

The software versions are also available from the Analog Devices PulSAR Analog to Digital Converter Evaluation Kit page. After downloading the software, it is recommended to use the WinZip “Extract” function to extract all of the necessary components as opposed to just clicking on *setup.exe* in the zipped file. After extracting, click on *setup.exe* in the folder created during the extraction and follow the instructions on the screen. If another version exists, it may be necessary to remove as detailed in the above CD-ROM section.

USB Drivers

The software will also install the necessary USB drivers. After installing the software, power up the CED board and connect to the PC USB 2.0 port. The Windows “Found New Hardware” Wizard will display. Click on Next to install the drivers automatically.

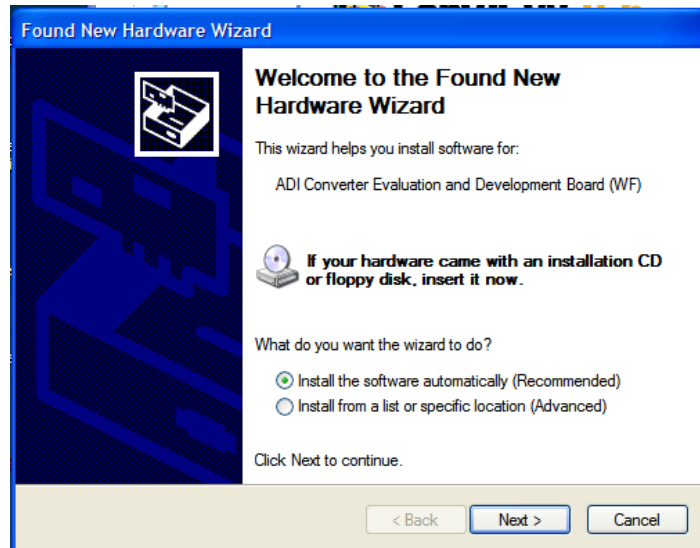

When installed properly, Windows displays the following.

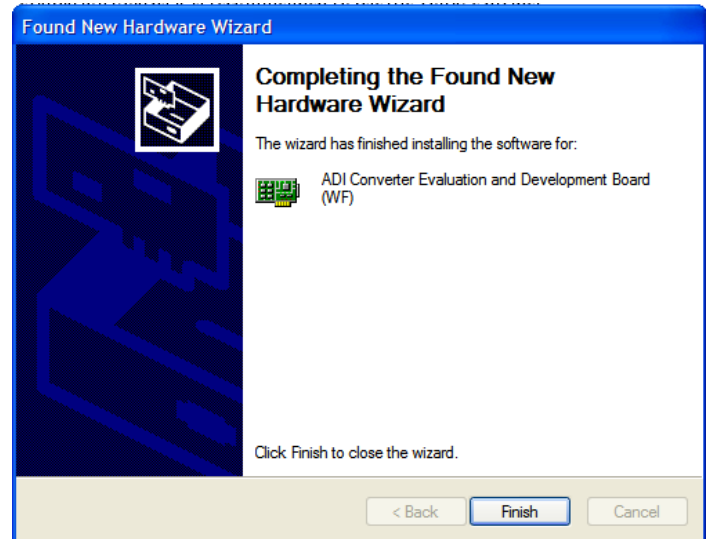

On some PCs, the Found New hardware Wizard may show up again and if so follow the same procedure to install it properly.

The “Device Manager” can be used to verify that the driver was installed successfully.

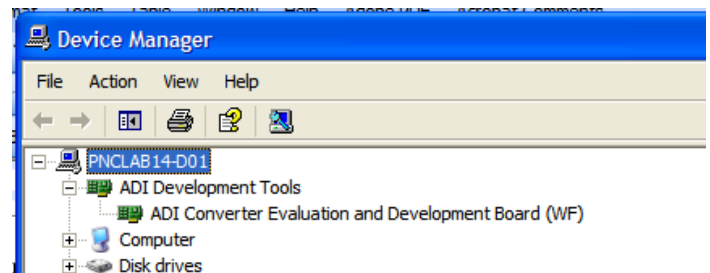

Troubleshooting the Install

If the driver was not installed successfully the device manager will display a question mark for “Other devices” as Windows does not recognize the CED1Z board.

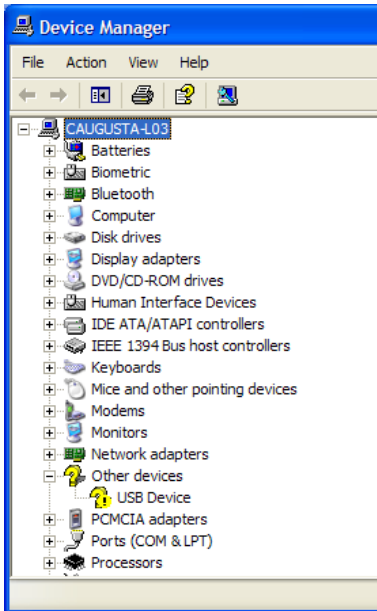

The “USB Device” can be opened to view its uninstalled properties.

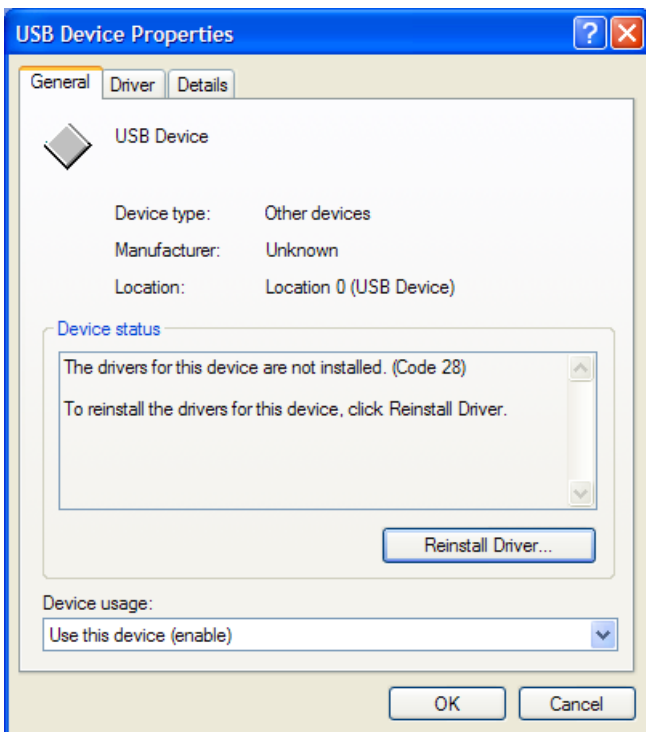

This is usually the case if the software and drivers were installed by a user without administrator privileges. If so, log on as an administrator with full privileges and reinstall the software.

RUNNING THE SOFTWARE

The evaluation board includes software for analyzing the AD7625 and AD7626 6MSPS and 10MSPS 16-bit ADC's. The EVAL-CED1Z is required when using the software. The software is used to perform the following tests:

- Histogram for determining code transition noise (DC)
- Fast Fourier transforms (FFT) for signal to noise ratio (SNR), SNR and distortion (SINAD), total harmonic distortion (THD) and spurious free dynamic range (SFDR)
- Decimation (digital filtering)

Refer to Figure 8 to Figure 14 for further details and features of the software.

The software is located at C:\Program Files\Analog Devices\AD7625_26 Evaluation Software\High-Res ADC Eval SW x_x.exe.

A shortcut is also added to the Windows “Start” menu under “Analog Devices AD7625_26 ADC Evaluation Software”, “AD7625_26 Eval SW x_x”. To run the software, select the program from either location.

DC TESTING - HISTOGRAM

This tests the ADC for the code distribution for DC input and computes the mean and standard deviation, or transition noise of the converter and displays the results. Raw data is captured and passed to the PC for statistical computations. To perform a histogram test, select “Histogram” from the test selection window and click on the “Start” radio button. Note: a histogram test can be performed without an external source since the evaluation board has a buffered $V_{REF}/2$ source at the ADC input. To test other DC values, apply a source to the J1/J2 inputs. It is advised to filter the signal to make the DC source noise compatible with that of the ADC. Install C48/C49 to provide this filtering if necessary.

AC TESTING

This tests the traditional AC characteristics of the converter and displays a Fast Fourier Transform (FFT) of the result. As in the histogram test, raw data is captured and passed to the PC where the FFT is performed displaying SNR, SINAD, THD and SFDR. The data can also be displayed in the time domain. To perform an AC test, apply a sinusoidal signal to the evaluation board at the SMB inputs J1/J2. Low distortion, better than 93dB, is required to allow true evaluation of the part. One possibility is to filter the input signal from the AC source. There is no suggested band pass filter but consideration should be taken in the choice. Furthermore, if using a low frequency bandpass filter when the full-scale input range is more than a few V_{pp} , it is recommended to use the on board amplifiers to amplify the signal, thus preventing the filter from distorting the input signal.

DECIMATED AC TESTING

The AC performances can be evaluated after digital filtering with enhanced resolution of up to 32 bits. Additional bits of resolution are attained when over sampling by equation 1.

1. $f_{\text{OVERSAMPLE}} = 4^N * f_{\text{SAMPLE}}$

where, N = number of bits of increased resolution and 4^N = the decimation ratio. Set the decimation to the amount of oversampling desired. Equation 1. is useful when the increased resolution is known. Example: to increase a 16-bit converter to 18-bits, N=2 thus the oversampling ratio would be 16. Since the software uses 2^N , the number entered must be 4.

Equation 2. is useful when the increase in SNR is desired.

2. $SNR_{\text{gain}}(dB) = 10 \log(\text{OversampleRatio})$

For example, for a 10dB increase in , the oversampling ratio must be 10X.

Table 1. Jumper Description

Jumper	Name	Default Position	Function
JP1, JP2 JP9, JP6	-	U13, U14	Buffer amplifier: Default for U13/U14 output. Use op amps to buffer analog input. Top pad to middle pad, input from J1, J2 (SMB).
VDRV-	-	-5V	Buffer amplifier negative supply: Selection of -12V or -5V.
VDRV+	-	+7V	Buffer amplifier positive supply: Selection of +12V, +7V or +5V.
VCC REF	-	+12V	Reference circuit positive supply: Selection of +12V or +7V.
VDD1	-	+5V	ADC VDD1 5V supply: Selection of 5V on board or external.
VDD2	-	+2.5V	ADC VDD2 2.5V supply: Selection of 5V on board or external.
VDDR	-	+5V	ADC VDD1 5V supply: Selection of 5V on board or external.
VIO	-	+2.5V	ADC digital input/output supply voltage: Selection of 2.5V

Table 2. Test Points (In order by type of signal)

Test Point	Available Signal	Type	Description
TP1	SIG+	Analog Input	Analog +input.
	SIG-	Analog Input	Analog -input.
	REF	Analog Input/Output	ADC Reference. Output if the AD7625/AD7626 internal reference is enabled. Input if internal reference is disabled.
	REFIN	Analog Input/Output	ADC bandgap output/reference buffer input. 1.2V present if the AD7625/AD7626 internal reference is enabled. Connect a 1.2V source if the internal bandgap is disabled and the reference buffer is enabled.
	MCLK	Digital Input	100MHz FPGA master clock input.
	BWR	Digital Input	EVAL-CED1Z buffered /WR strobe
	BBUSY	Digital Output	EVAL-CED1Z buffered BUSY strobe
	BRD	Digital Input	EVAL-CED1Z buffered /RD strobe
	VDD1	Power	AD7625/AD7626 VDD1.
	VDD1	Power	AD7625/AD7626 VDD1.
	VDD2	Power	AD7625/AD7626 VDD2.
	VDRV+	Power	Positive rail amplifier supply (AMP +)
	VDRV-	Power	Negative rail amplifier supply (AMP -)
	VIO	Power	AD7625/AD7626 VIO.
	4V REF	Reference	ADR434 output voltage
	-5VA	Power	-5V analog from EVAL-CED1Z board.
	+5V	Power	+5V analog from EVAL-CED1Z board.
	-12VA	Power	-12V analog from EVAL-CED1Z board.
+12VA	Power	+12V analog from EVAL-CED1Z board.	
TP7,TP8, TP16, TP23, TP24, TP25,TP26	GND	GND	System GND.

Table 3. Bill of Materials for the Connectors

Ref Des	Connector Type	Manf.	Part No.
J1, J2	RT Angle SMB Male	Pasternack	PE4177
P4	32X3 RT PC MOUNT CONNECTOR	ERNI	533402

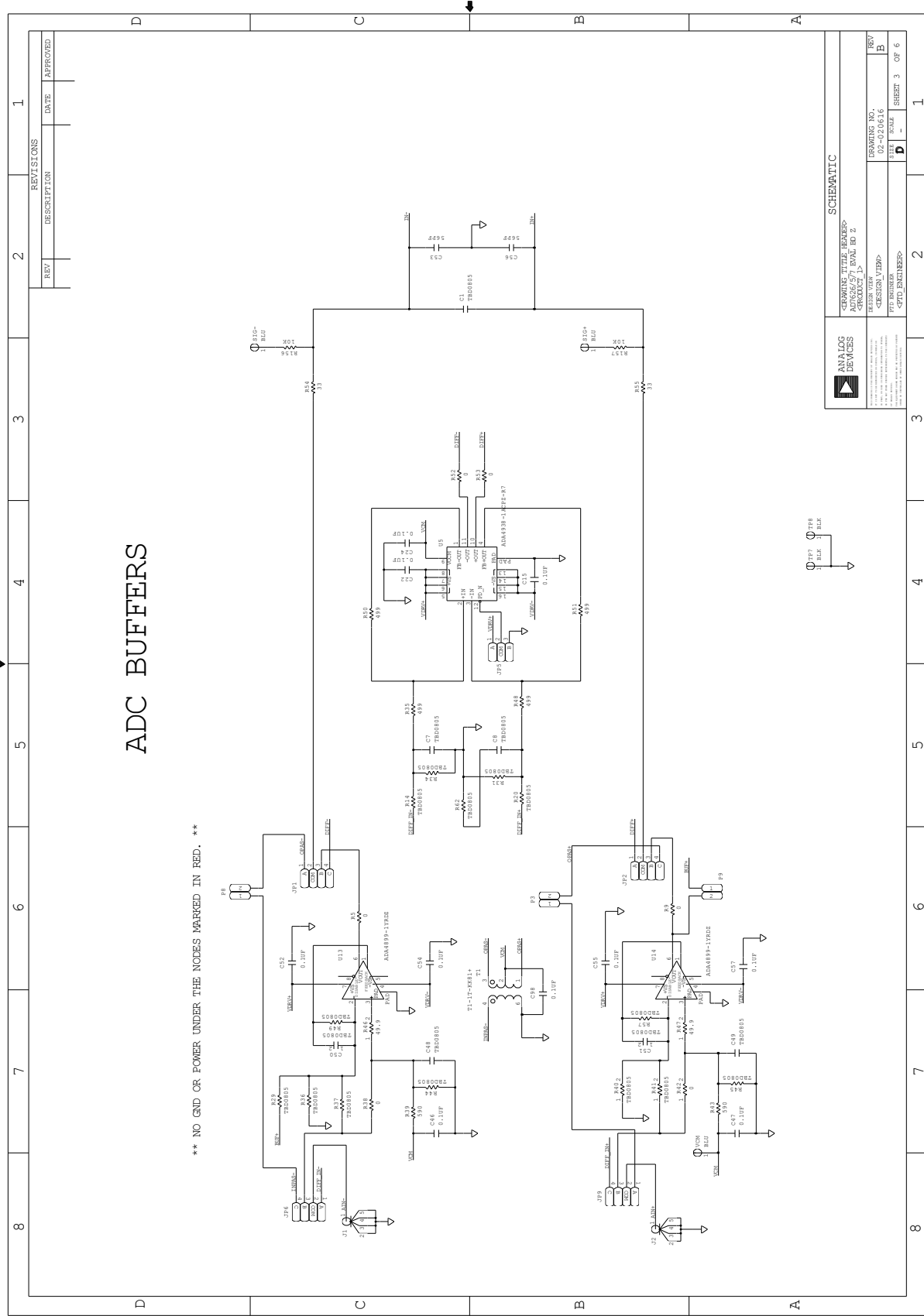

ADC BUFFERS

** NO GND OR POWER UNDER THE NODES MARKED IN RED. **

REV		REVISIONS	
REV	DESCRIPTION	DATE	APPROVED

ANALOG DEVICES		SCHEMATIC	
<DRAWING TITLE: BUFFER> <PART NUMBER: AD7625/26EDZ> <DESIGNER: J. J. ...> <DATE: 03-20-01> <FILE: ...> <SHEET: 3 OF 6>		<DRAWING TITLE: BUFFER> <PART NUMBER: AD7625/26EDZ> <DESIGNER: J. J. ...> <DATE: 03-20-01> <FILE: ...> <SHEET: 3 OF 6>	

Figure 4. Schematic, Analog

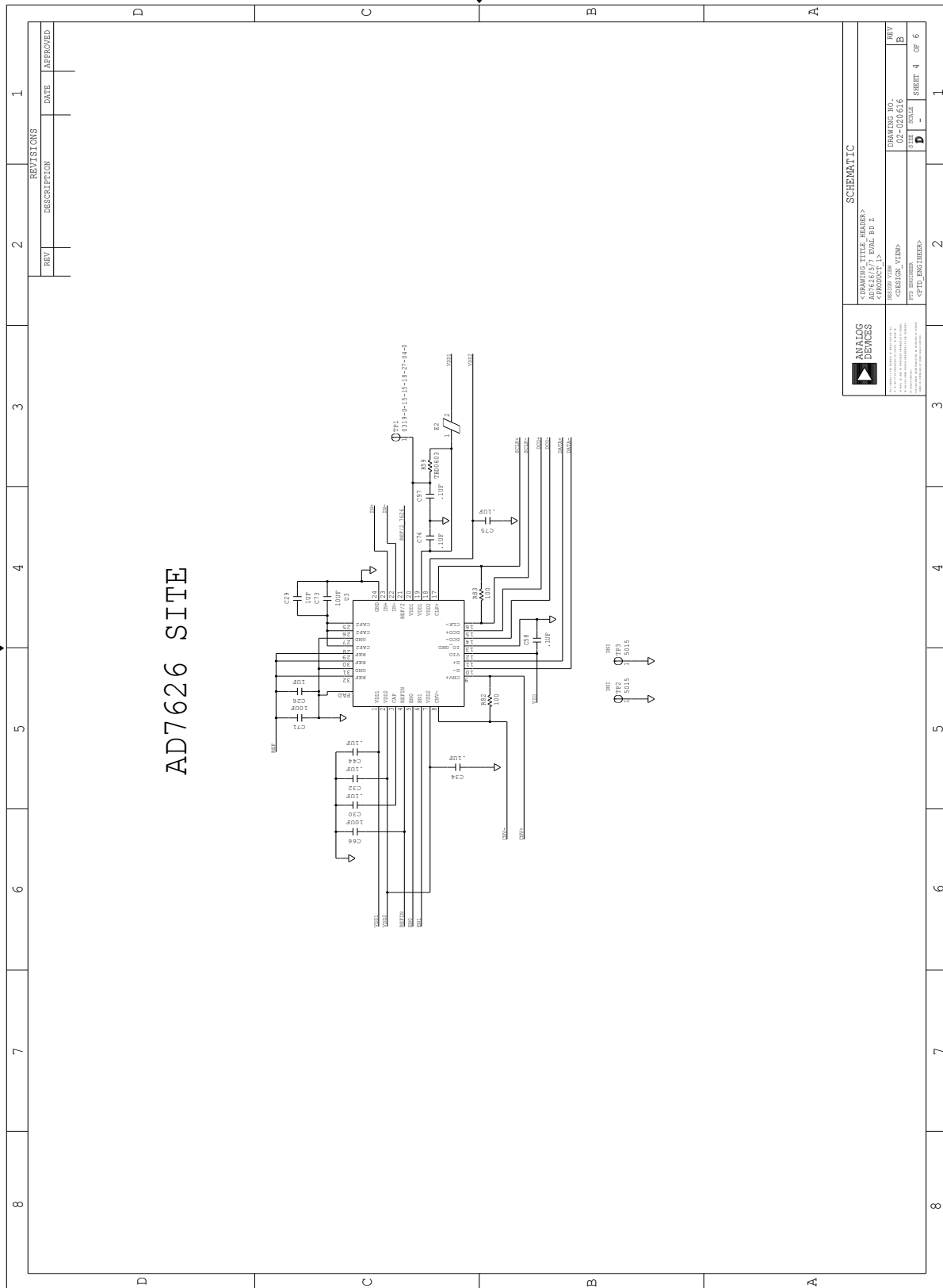

Figure 5. Schematic, ADC

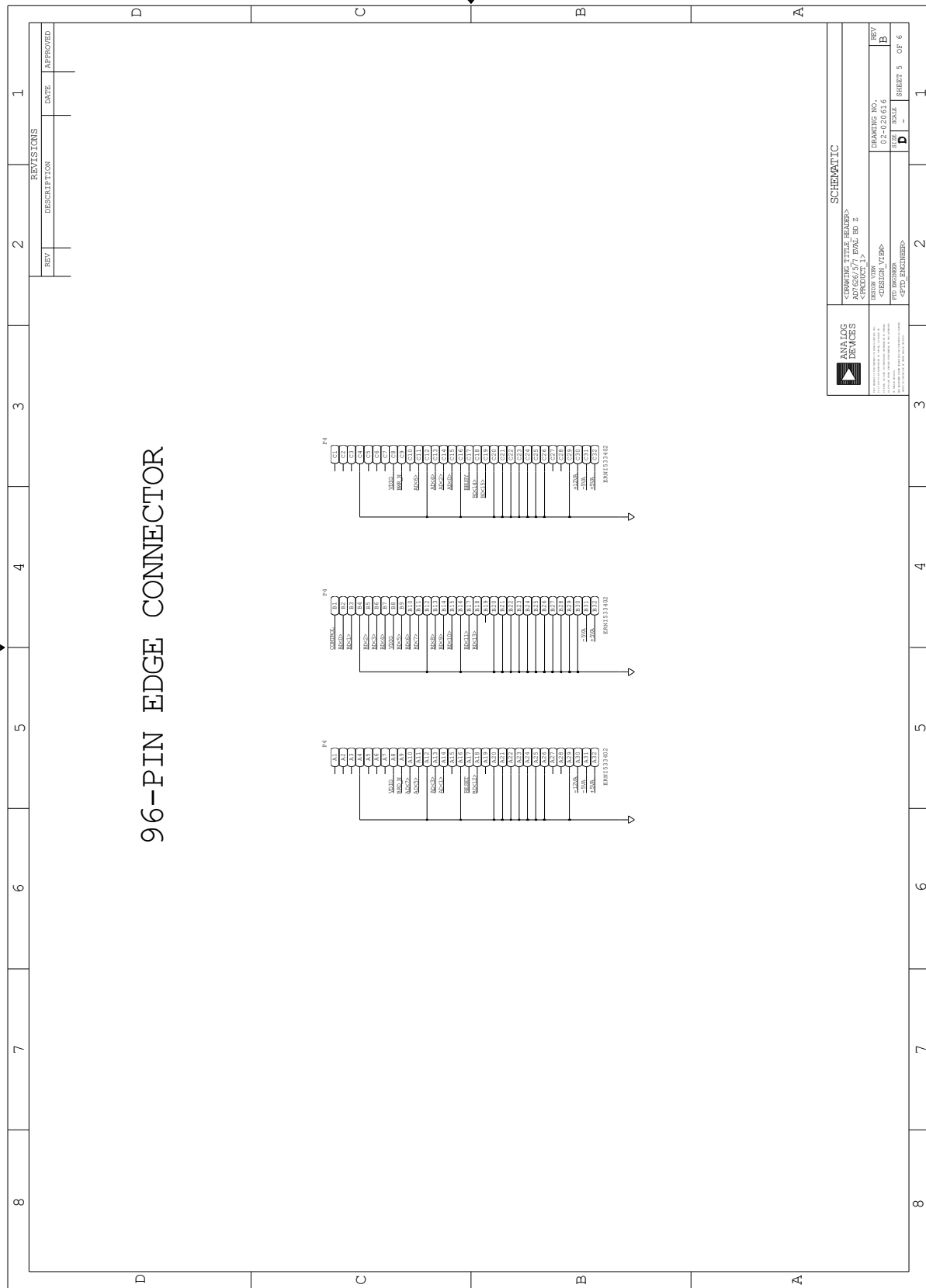

Figure 6. Schematic, 96-Pin Interface

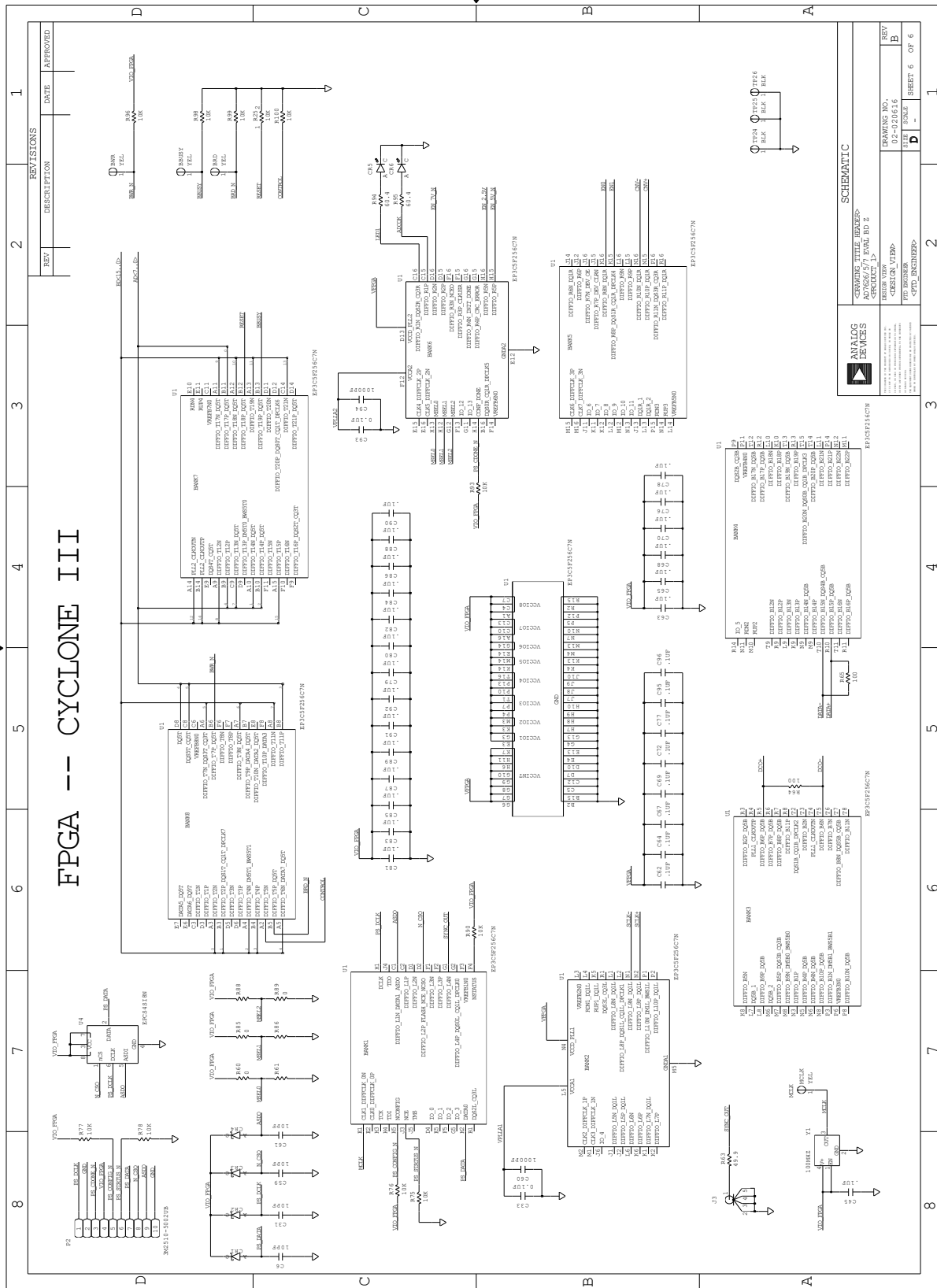

Figure 7. Schematic, FPGA

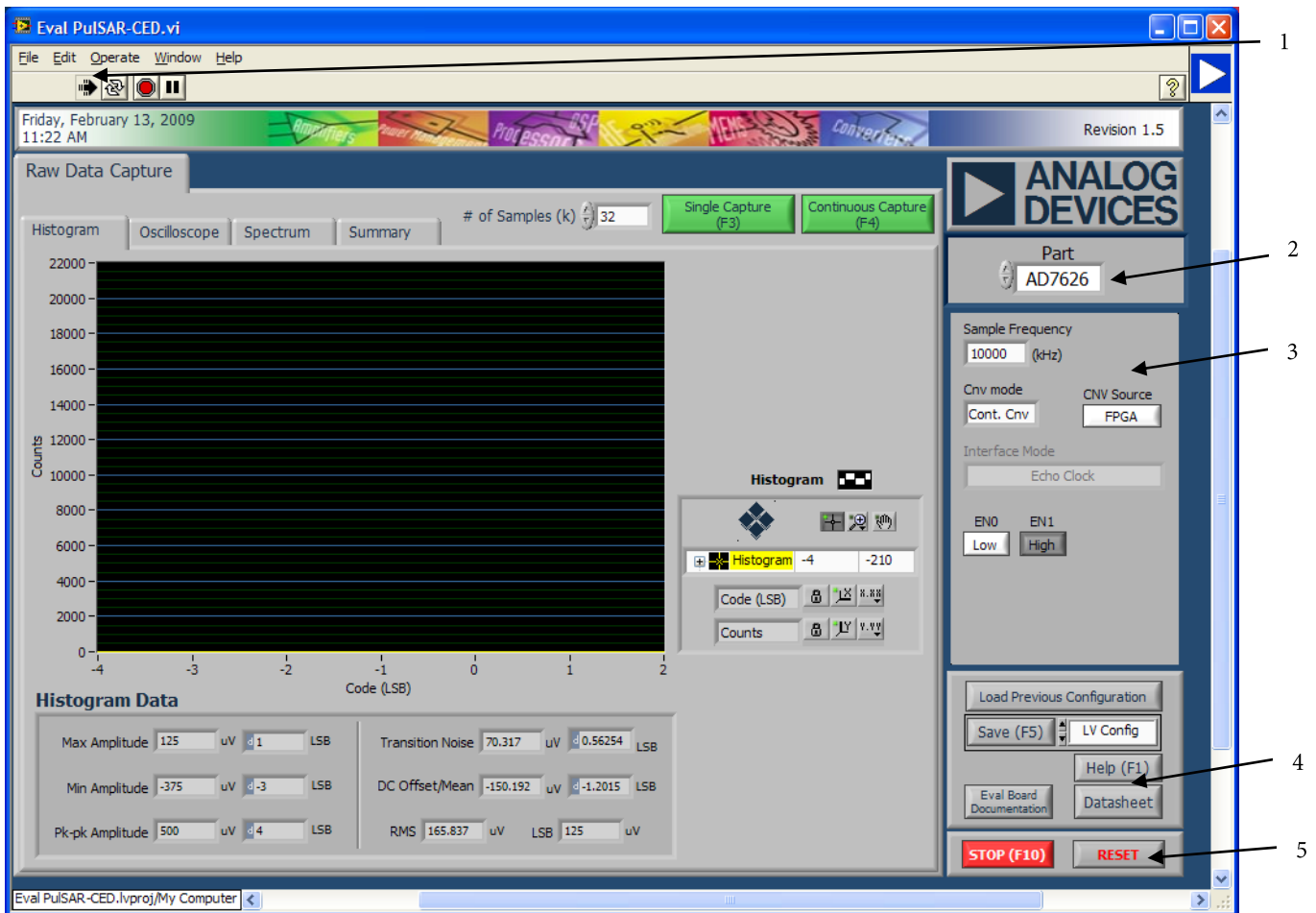



Figure 8. Setup Screen

The following details the operation of the C:\Program Files\Analog Devices\AD7625_26 Evaluation Software\High-Res ADC Eval SW 1_3.exe software.

1. The arrow  is used to start the software. When running  is displayed.

2. The part to be evaluated is selected here.

3. The controls are used to set:

Sample Frequency – Enter the sample in kHz. Units can be used such as 10k (case sensitive) for 10,000,000 Hz or 10MSPS.

CNV Source - Selections between evaluation board or external.

CNC Mode – This selects between continuous (Cont.) or Burst conversion modes. In continuous mode, the ADC is continuously converting. In burst mode, the ADC is not converting (sample clock held in inactive state) and the conversions begin once the “Single Capture” or “Continuous Capture” buttons have been selected. Note that at this time, burst mode does not work and is simply a place holder for future software versions.

ENO, EN1 – These controls toggle the EN[1:0] AD7625/AD7626 pins and can be used to power down the ADC, power down the internal reference, etc.

4. These controls are used for saving, printing, help, etc. and are also accessed in the File menu.

Save (F5): type – LabView config, allows the current configuration to be saved to a *filename.dat* file. Useful when changing many of the default controls. To load the saved configuration, use the Load Previous Configuration.

Type – Html, saves the current screen shot to an Html file.

Type – Spreadsheet, saves the current data displayed in the chart in a tab delimited spreadsheet. Raw ADC Data is time domain in V or Code, FFT or Decimated is in dB.

5. Stop (F10) is used to stops the software. The  can also be used to stop the software. RESET is used to reset the CED or ECB capture boards.

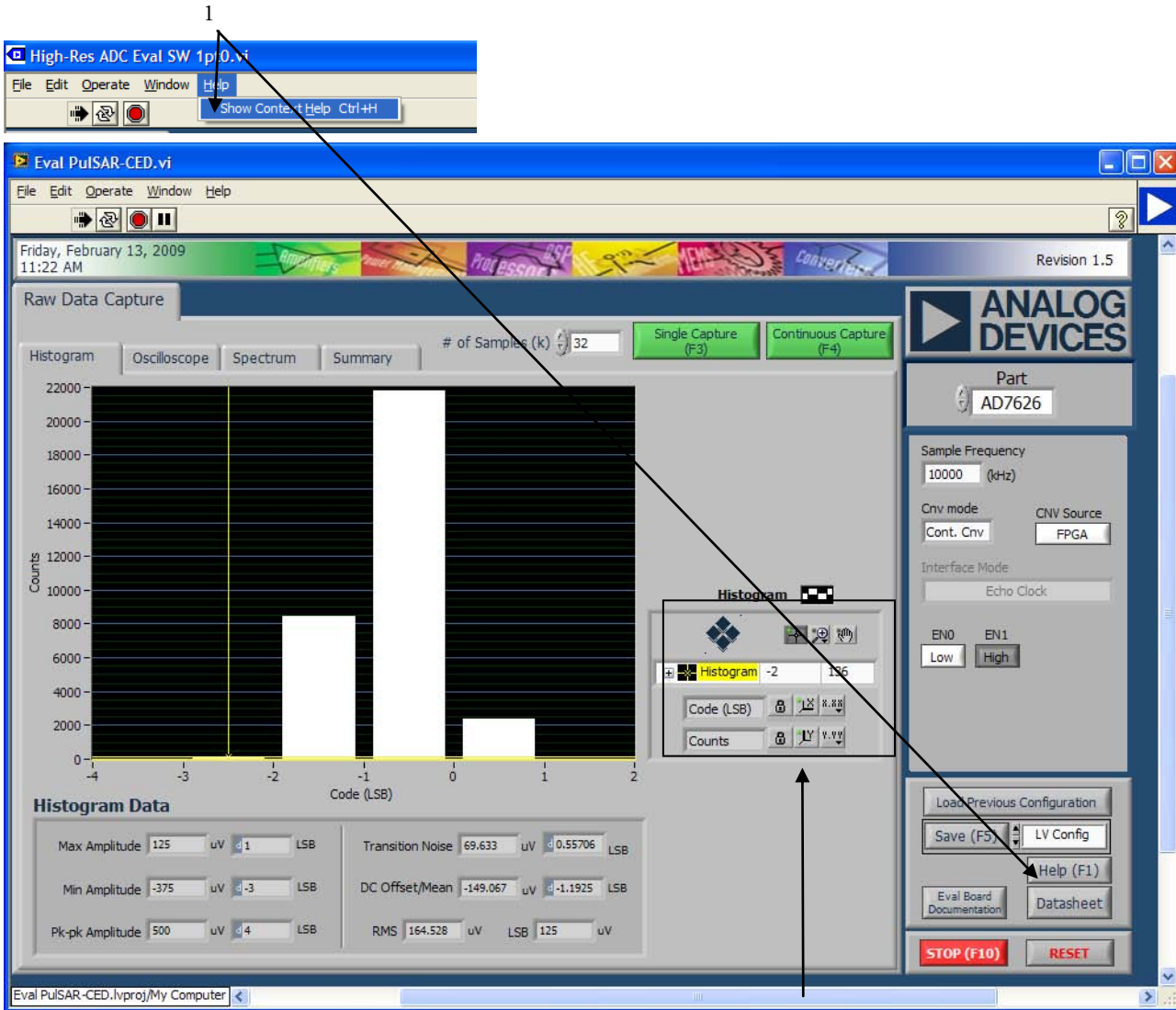







Figure 9. Context Help

2

1. To use the on-screen help. Select Help, Show Context Help or click the Help (F1). Placing the cursor on most screen items displays useful help for the particular control or displayed unit.

2. These controls are used for axes and zooming panning.

-  Locks the graph axis to automatically fit the data.
-  Uses last axis set by user.   rescale the axes to the automatic values.
-   are used to set axes properties such as format, precision, color, etc.

 Displays the cursor.

 Is used For zooming in and out.

 Is used for panning.

 Is used to set various graph properties such as graph type, colors, lines, etc.

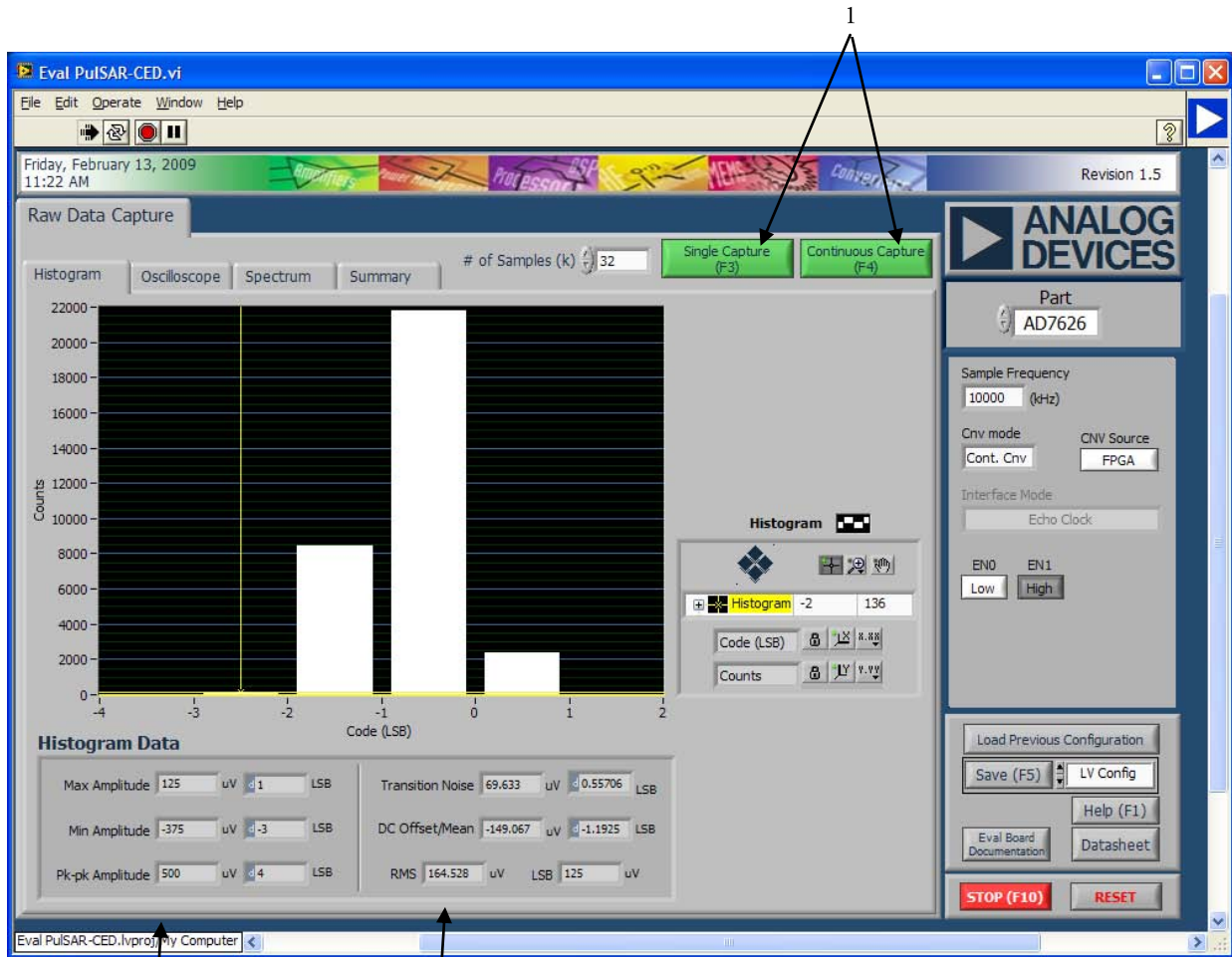
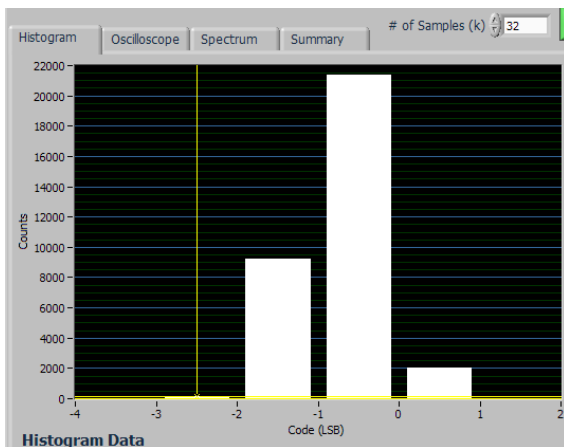
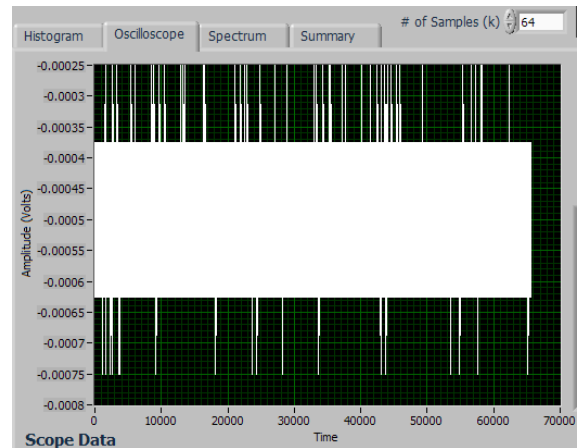

Figure 10. Histogram Screen

1. These radio buttons are used to perform a Single Capture or Continuous Capture of data set in the # of Samples field. The results are displayed in the chart. Note that the results can be displayed as:



A Histogram



Or an Oscilloscope (time domain)

2., 3. These display the statistics for the X and Y-axes, respectively.

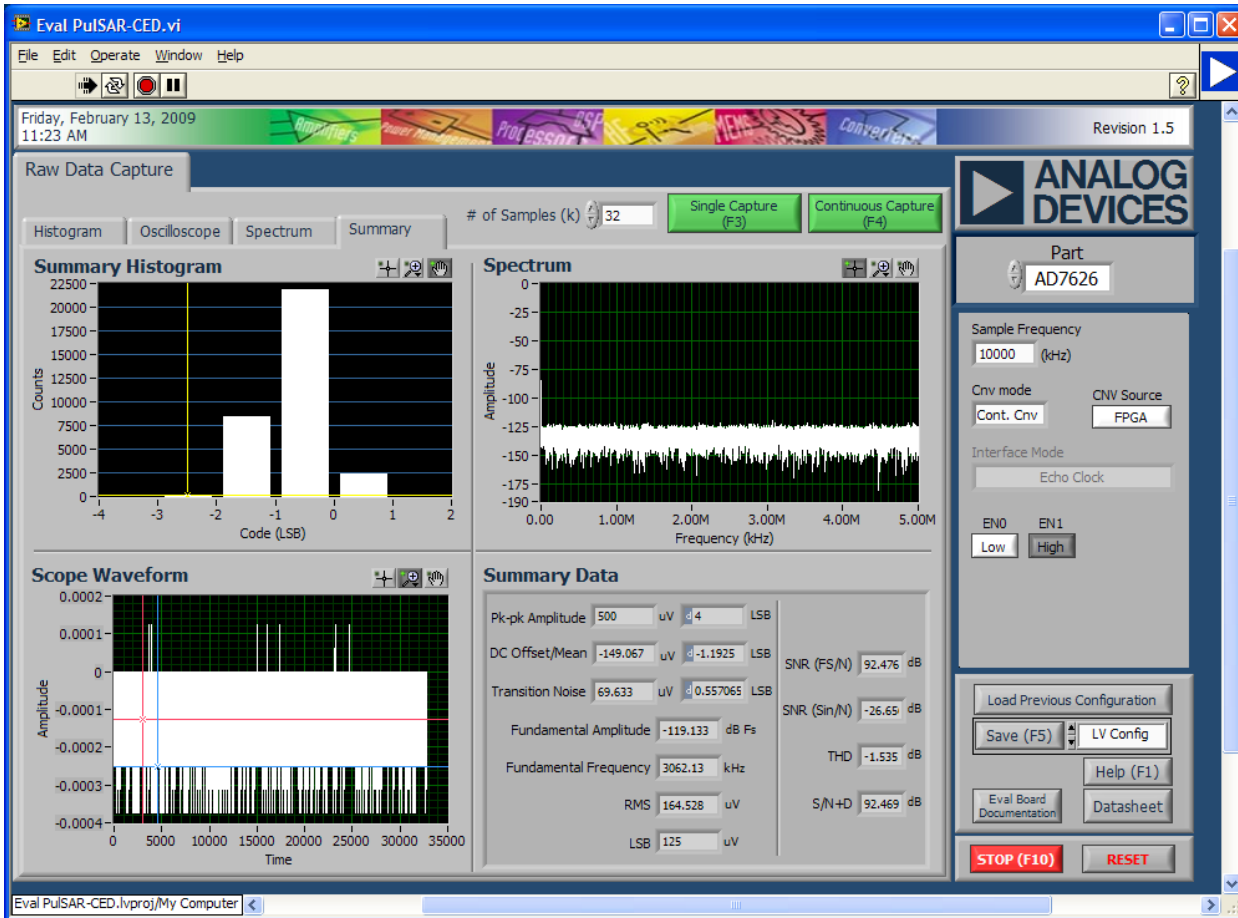

Figure 11. Summary

The charts can be displayed together when the **Summary** tab is selected.

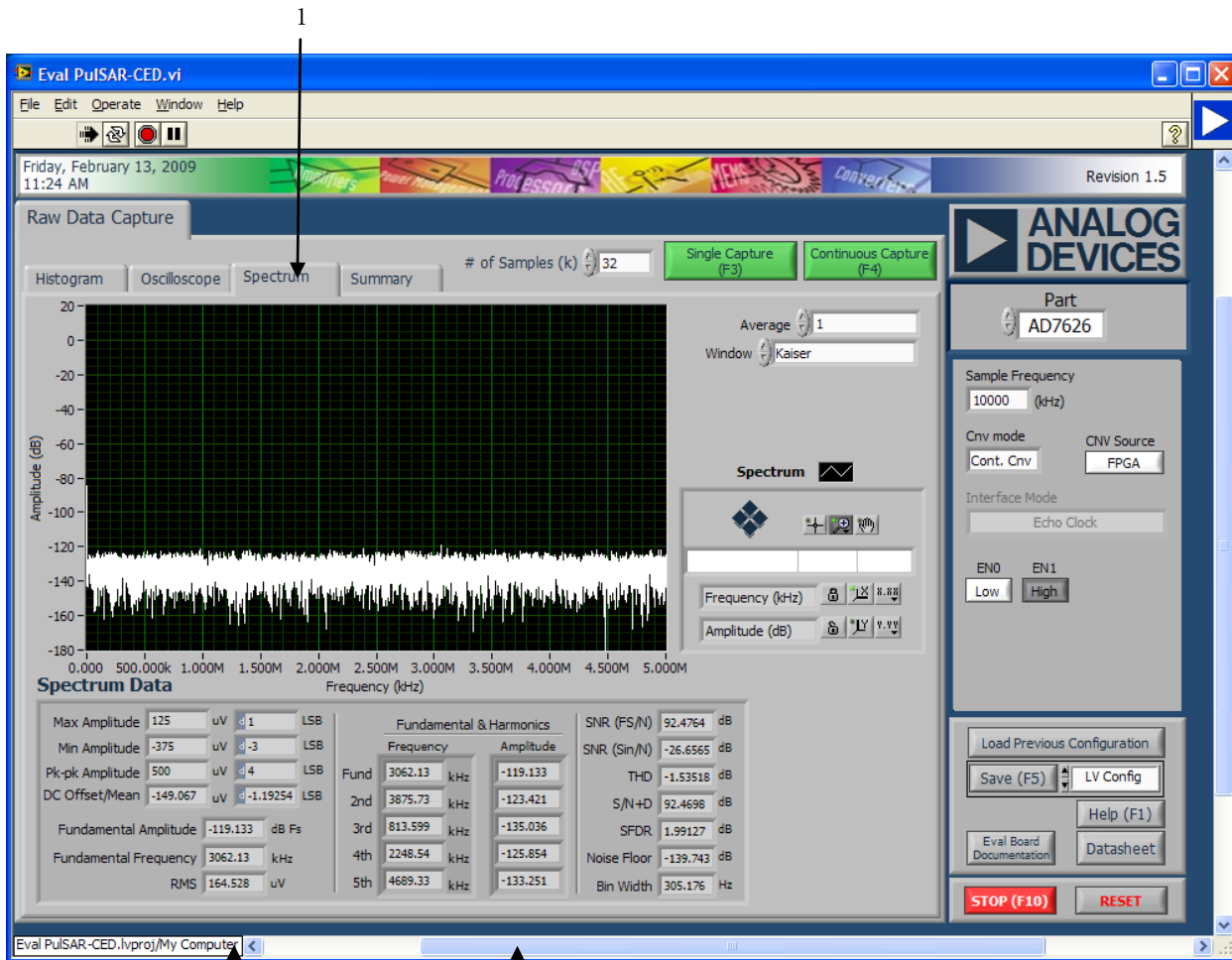

Figure 12. FFT Spectrum

1. Displays the FFT when the Spectrum chart is selected
- 2., 3. Display the data for the X and Y-axes, respectively.

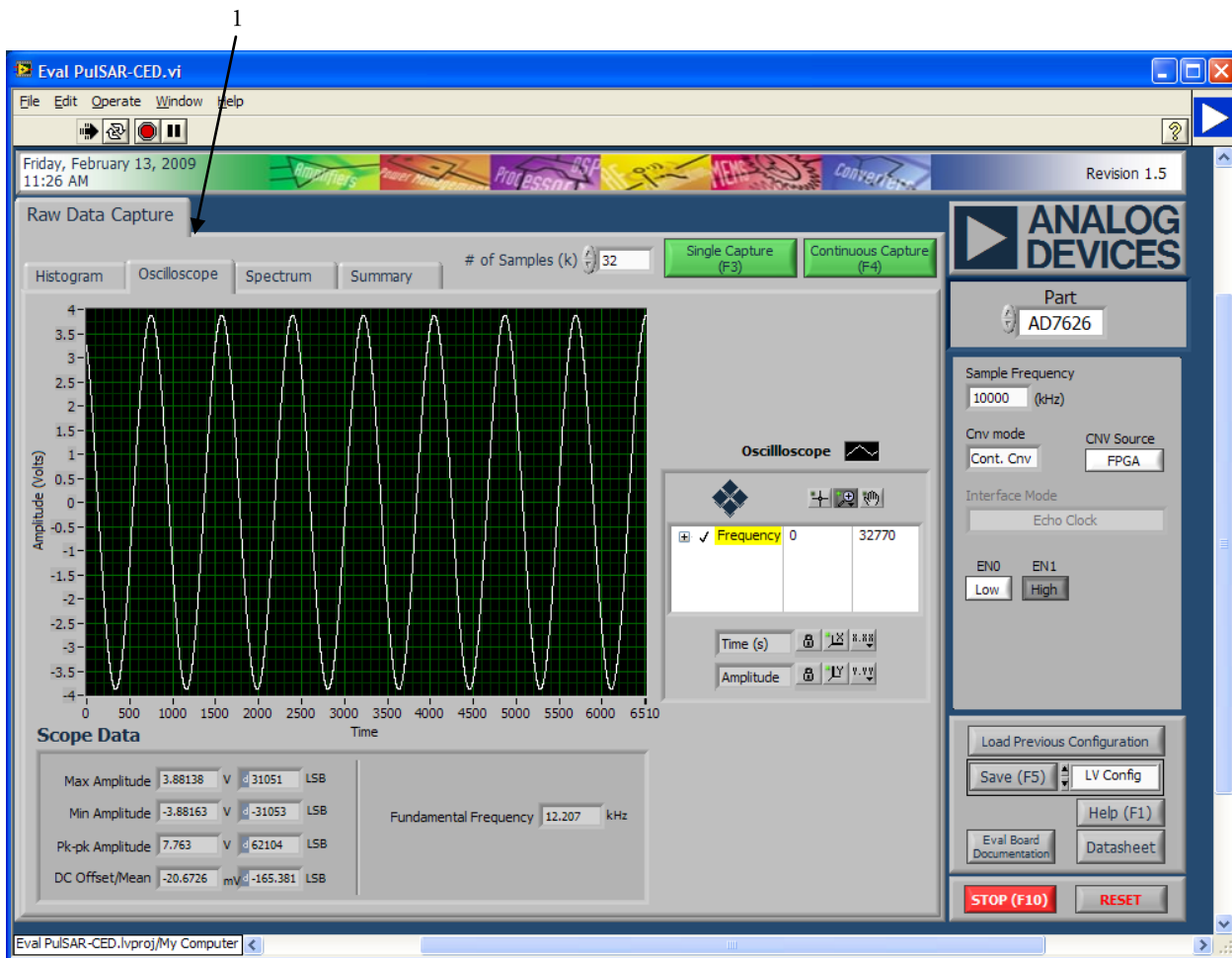

Figure 13. Oscilloscope

1. Time domain data can be viewed with the oscilloscope also.

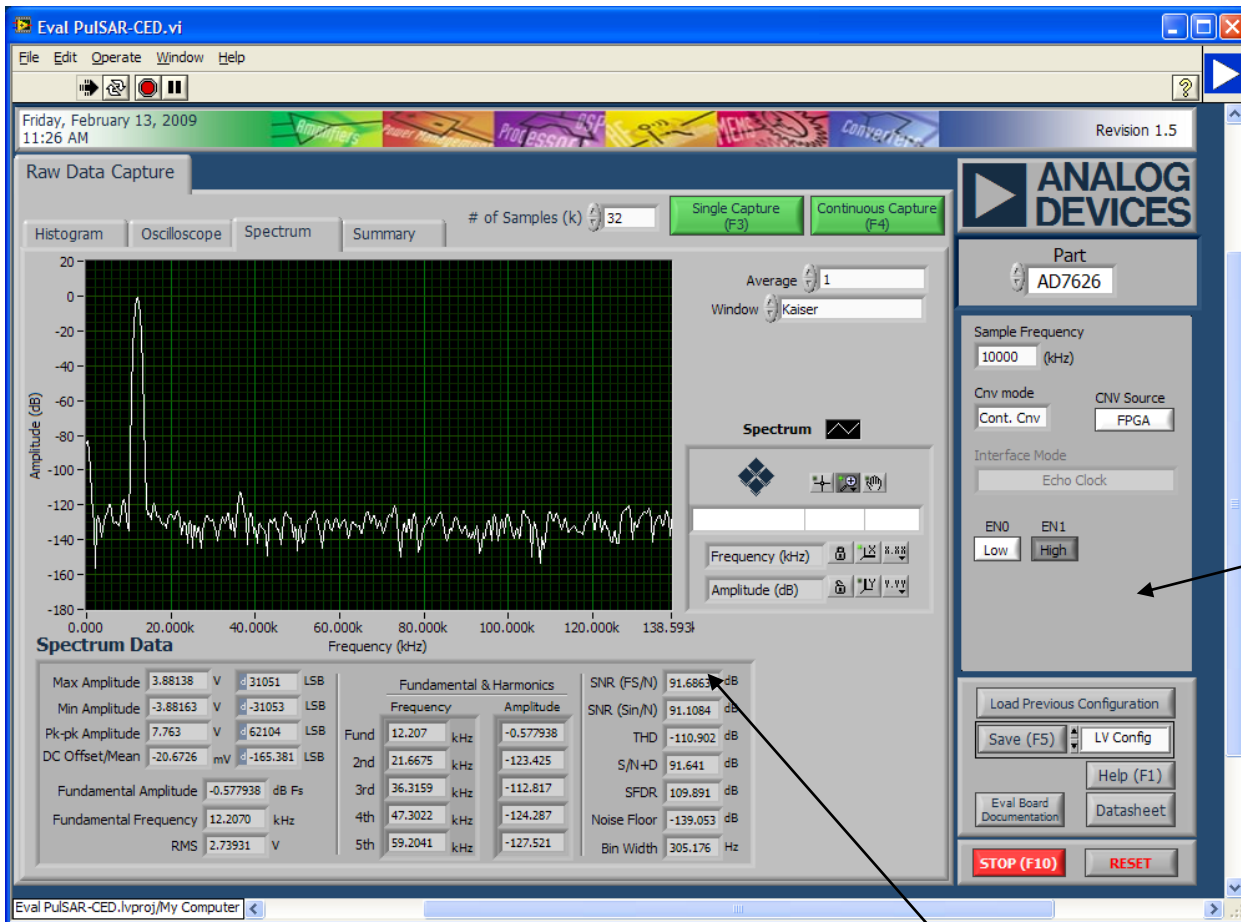

Figure 14. Decimated FFT

1. Enter a value to oversample the ADC for increased system resolution as detailed in the Decimated AC Testing section. Note that for every power of 4, the effective resolution increases by 6dB or 1 bit (power of 10, increases by 10dB). Since the software uses 2^n to decimate, use $n+n$ for the increase in bits. Example, oversample for 1 more bit of resolution would be 2^2 ; oversample for 2 bits more of resolution = 2^4 , etc.

4. The Nyquist frequency is displayed as:

$$F_{NYQUIST} = \frac{SampleFrequency}{2^{(N+1)}}$$

BILL OF MATERIALS

Name	Value	Description	Manufacturer	Manufacturer Part #
+5VA,VDIG,+12VA	RED	CONN-PCB TST PNT RED	COMPONENTS_CORPORATION	TP-104-01-02
-5VA,-12VA	WHT	CONN-PCB TST PNT WHT	COMPONENTS_CORPORATION	TP-104-01-09
REF,VCM,VIO,SIG+,SIG-,VDD1,VDD2,REFIN,VDRV+,VDRV-,4VREF+	BLU	CONN-PCB TST PNT BLU	COMPONENTS_CORPORATION	TP104-01-06
A1	ADR434BRZ	4.096 VOLTAGE REF	ADI	ADR435BRZ
A2,A3	ADP3334ARZ	LOW IQ ADJ LOW DROP REG	ADI	ADP3334ARZ
A4	ADR280ARTZ	1.2V ULTRALOW VOLT REF	ADI	ADR280ARTZ
A5,A6	AD8031BRZ	RAIL-RAIL I/O AMP	ADI	AD8031BRZ
BRD,BWR,MCLK,VREF,BBUSY	YEL	CONN-PCB TST PNT YEL	COMPONENTS_CORPORATION	TP-104-01-04
C1,C7,C8,C39,C48-C51	TBD0805	DO NOT INSTALL	TBD0805	TBD0805
C10-C14,C16,C35,C38,C41,C66,C71,C73	10UF	CERAMIC CAP	MURATA	GRM21BR61C106KE15L
C2,C3,C15,C22,C24,C33,C36,C40,C46,C47,C52,C54,C55,C57,C93,C98,C99	0.1UF	E007204	PANASONIC	ECJ-1VB1C104K
C9,C17-C21,C23,C25	4.7UF	CAP CER X5R	MURATA	GRM21BR61E475KA12L
C26,C29	1uF	CAP CER LLL219	MURATA	LLL219R70J105MA01L
C27,C28,C37,C42,C43	2.2UF	CAP CER	MURATA	GRM21BR71E225KA73L
C30,C32,C34,C44,C45,C58,C62-C65,C67-C70,C72,C74-C92,C95-C97	.1UF	E006560/A004-0011-066	PHYCOMP (YAGEO)	04022F104Z7B20D
C6,C31,C59,C61	10PF	CAP CER NP0	PANASONIC	ECU-VIH100FCV
C4,C5	1000PF	CAP CER NP0	PANASONIC	ECU-V1H102JCX
C53,C56	56PF	CAP CER NP0	PANASONIC	ECU-V1H560JCG
C60,C94	1000PF	E000208/A004-0008-005	PANASONIC	ECH-U1H102JB5
CR1-CR4	B220A-13-F	DIODE SCHOTTKY RECTIFIER	DIODES INCORPORATED	B220A-13-F
CR5,CR6	CMD28-21VGCTR8T	DIODE LED GREEN SMD	CHICAGO MINI LAMP	CMD28-21VGCTR8T1

Preliminary Technical Data

EVAL-AD7625/26EDZ

Name	Value	Description	Manufacturer	Manufacturer Part #
	1			
E2	BMB2A1000 LN2	FERRITE CHIP BEADS	MEGGITT SIGMA	FEC 323-7989
J1,J2	JOHNSON1 31-3701-301	COAX SMB RA	JOHNSON	131-3701-301
J3	JOHNSON1 42-0701-201	CONN-PCB COAX SMA ST	JOHNSON	142-0701-201
P6,P13	MOLEX22-03-2031	STRAIGHT HEADER 3PIN	MOLEX	22-03-2031
P2	3M2510-5002UB	HDR SHRD RA 10P MALE	3M	2510-5002UB
P4	ERNI533402	DIN RA 96P MALE	ERNI	533402
R1,R3,R7,R15,R19	60.4K	RES THICK FILM CHIP R0805	PANASONIC	ERJ-6ENF6042V
R5,R8-R10,R13,R22,R23,R30,R32,R38,R42,R52,R53,R60,R69,R70,R85,R89	0	RES JMPR SMD 0805 (SHRT)	PANASONIC	ERJ-6GEYJ0.0
R25,R75-R78,R90,R93,R96,R98-R100	10K	RES PREC THICK FILM CHIP R0603	PANASONIC	ERJ-3EKF1002V
R11,R12,R33,R156,R157	10K	RES PREC THICK FILM CHIP R0805	PANASONIC	ERJ-6ENF1002V
R14,R20,R24,R27,R29,R31,R34,R36,R37,R40,R41,R44,R45,R49,R57,R62	TBD0805	DO NOT INSTALL	TBD0805	TBD0805
R16	210K	RES PREC THICK FILM CHIP R0805	PANASONIC	ERJ-6ENF2103V
R17	64.9K	RES PREC THICK FILM CHIP R0805	PANASONIC	ERJ-6ENF6492V
R18	300K	RES CHIP SMD 0805	YAGEO	RC0805FR-07300KL
R2,R6,R21	130K	RES PREC THICK FILM CHIP R0805	PANASONIC	ERJ-6ENF1303V
R26,R28	1K	RES PREC THICK FILM CHIP R0805	PANASONIC	ERJ-6ENF1001V
R35,R48,R50,R51	499	RES CHIP SMD 0805	IRC	PFC-W0805R-03-4990-B
R39,R43	590	RES PREC THICK FILM CHIP R0805	PANASONIC	ERJ-6ENF5900V
R4	120K	RES FILM SMD 0805	MULTICOMP	MC 0.1W 0805 1% 120K.
R46,R47,R63	49.9	RES PREC THICK FILM CHIP	PANASONIC	ERJ-6ENF49R9V

Name	Value	Description	Manufacturer	Manufacturer Part #
		R0805		
R54,R55	33	RES FILM SMD 0805	PANASONIC	ERJ-6GEYJ33
R59,R61,R86,R88	TBD0603	DO NOT INSTALL	TBD0603	TBD0603
R64,R65,R82,R83	100	RES FILM SMD 0402	VENKEL	CR0402-16W-1000FPT
R73	1M	RES PREC THICK FILM CHIP R0805	PANASONIC	ERJ-6ENF1004V
R94,R95	60.4	RES PREC THICK FILM CHIP R0805	PANASONIC	ERJ-6ENF60R4V
T1	T1-1T- KK81+	XFMR RF	MINI CIRCUITS	T1-1T-KK81+
TP1	0319-0-15- 15-18-27- 04-0	CONN-PCB PIN RECEPTACLE	MILL-MAX	0319-0-15-15-18-27-04-0
TP7,TP8,TP16,TP24- TP26	BLK	CONN-PCB TST PNT BLK	COMPONENTS_CORPORATION	TP-104-01-00
U1	EP3C5F256 C7N	IC CYCLONE III FINELINE BGA	ALTERA	EP3C5F256C7N
U7-U9,U11	ADP1708AR DZ-R7	IC-ADI LOW DROPOUT CMOS LIN REG	ADI	ADP1708ARDZ-R7
U13, U14	ULTRA LOW DISTORTION ""	IC-ADI UNITY GAIN STABLE	U13,U14	ADA4899-1YRDZ
U4	EPCS4SI8N	IC SERIAL CONFIG DEVICE	ALTERA	EPCS4SI8N
U5	ADA4932- 1ACPZ-R7	DIFF ADC DRIVER	ADI	ADA4938-1ACPZ-R7
Y1	100MHZ	IC CRYSTAL OSC	C-MAC	SPX0009437-CFPS-73
TP2,TP3	5015	CONN-PCB SMT TEST POINTS	KEYSTONE ELECTRONICS CORP	5015

ORDERING GUIDE

Evaluation Board Model	Product
EVAL-AD7625EDZ	AD7625BCPZ
EVAL-AD7626EDZ	AD7626BCPZ
EVAL-CED1Z	USB Capture Board